

Disney • PIXAR

AGES 4+
3116

TOY STORY AND BEYOND!

Disney • PIXAR

Buzz Lightyear's Intergalactic Headquarters & Buzz Lightyear's Star Command Cruiser

Thank you for purchasing this Toy Story toy! For maximum play value, be sure to read and follow instructions.

Batteries included. Replace with 3 x 1.5V "AA" or R6 size batteries. Alkaline batteries recommended. Phillips/cross head screwdriver (not included) needed to replace batteries.

Playset comes with skiff, radar dish, launchers, 2 projectiles, prisoner containment unit, spaceship, space rove vehicle, Buzz Lightyear figure and Zurg figure.

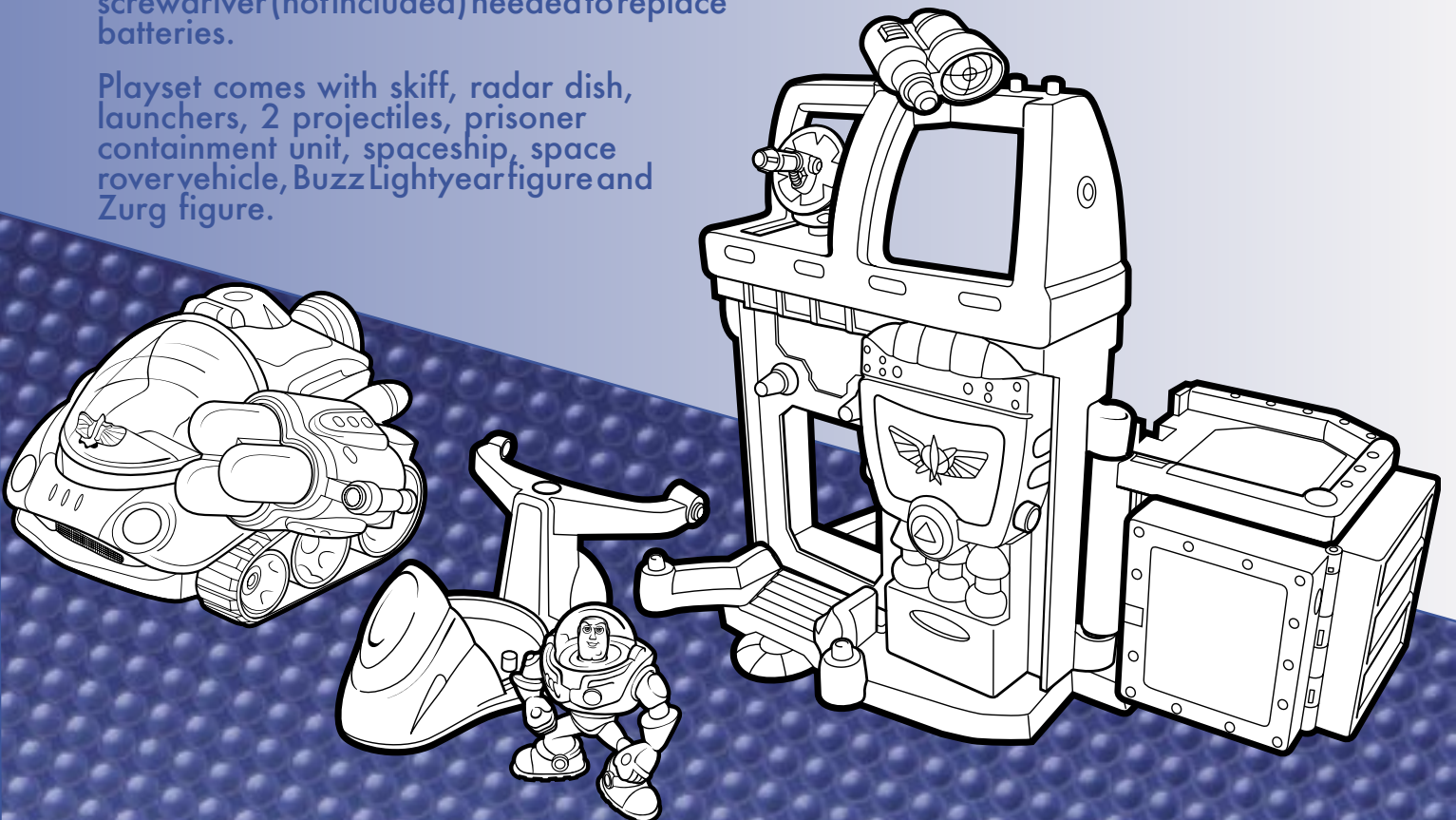

To Assemble

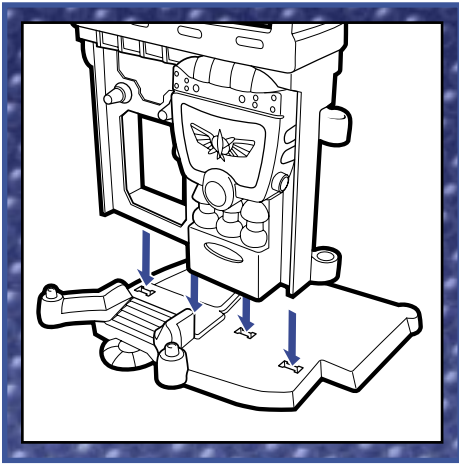

- Snap center section of playset onto base.

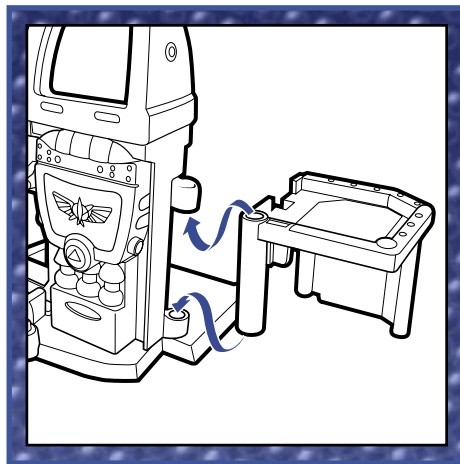

- Snap prison cell onto center section as shown.



- Snap prisoner containment unit onto prison cell.

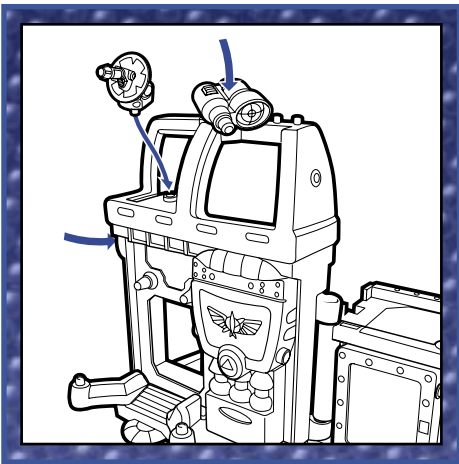

- Snap-on gun/scope and radar dish can attach to several places on the playset.

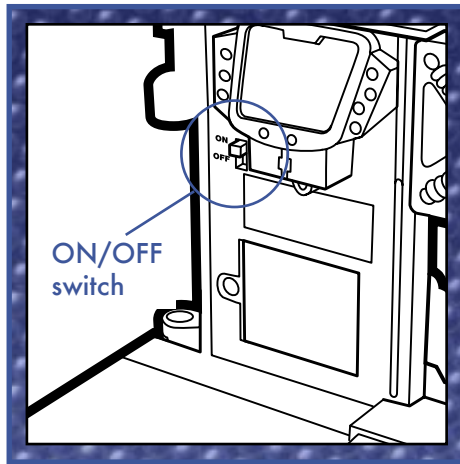

- Make sure ON/OFF switch is in "ON" position for electronic lights and speech.

Note: To conserve batteries, move switch to "OFF" position when you're not using the playset.

To Play

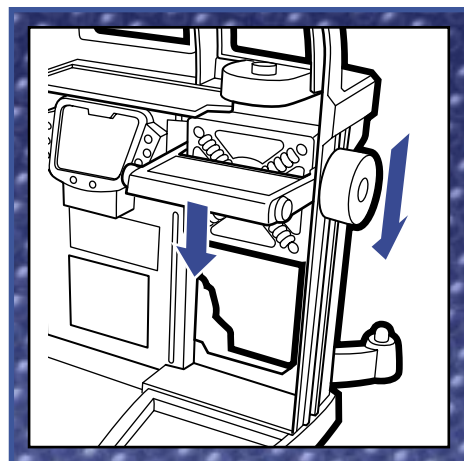

- Push slide up and down to move elevator!

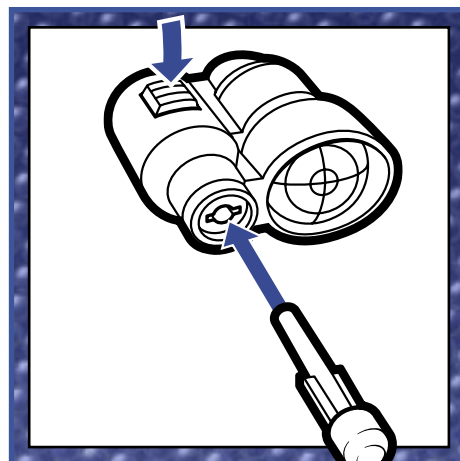

- Push button on gun to fire projectile!

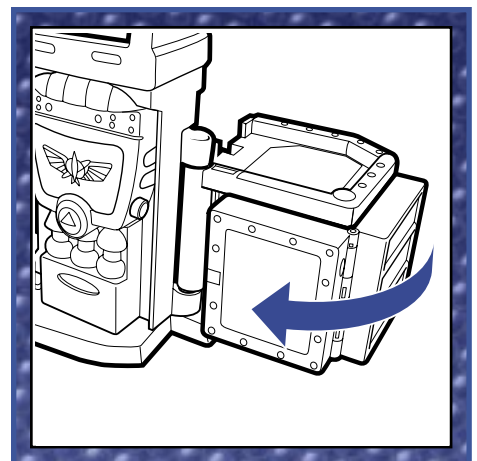

- Prison cell swivels out!

To Play (continued)

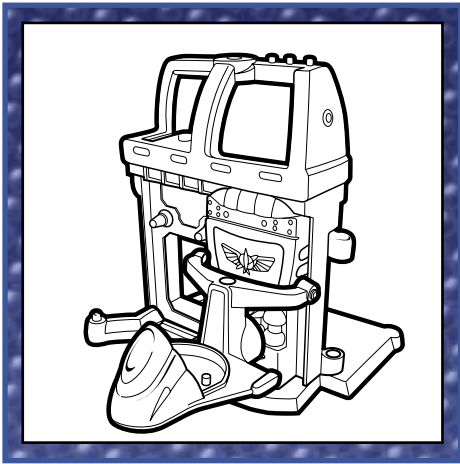

- 2 docking stations for skiff (indicated by red dots)!

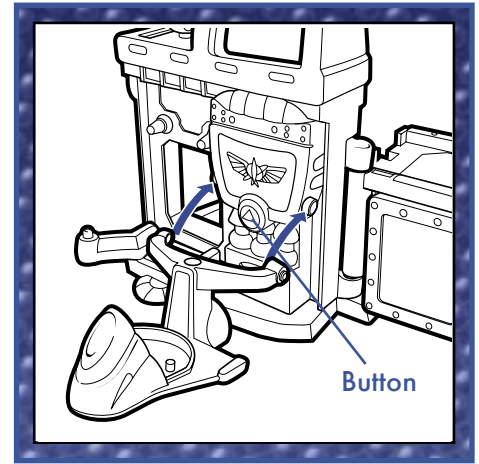
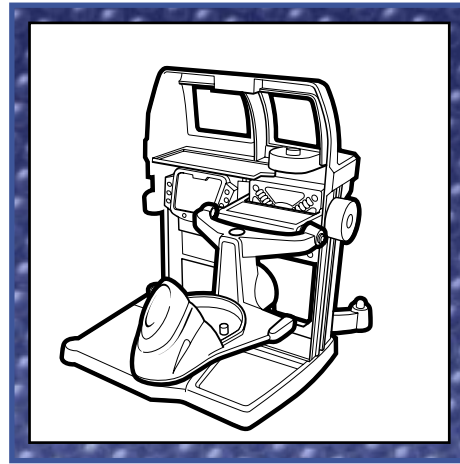

- Dock skiff in front of computer screen, then press gently on skiff for electronic speech and lights! (Electronic features can also be activated by pressing button under the computer screen.)

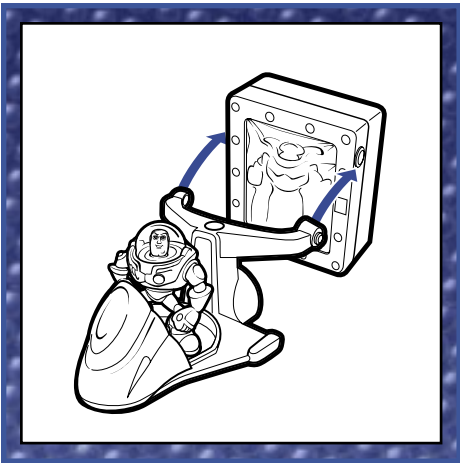

- Squeeze containment unit shut, then detach and snap onto skiff!

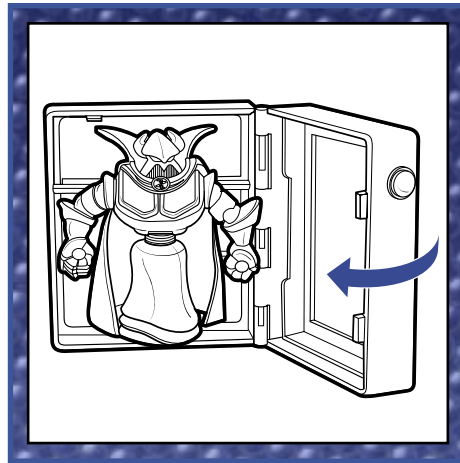

- Zurg figure fits inside containment unit when placed inside as shown. If figure is placed in any other position, unit will not close properly.

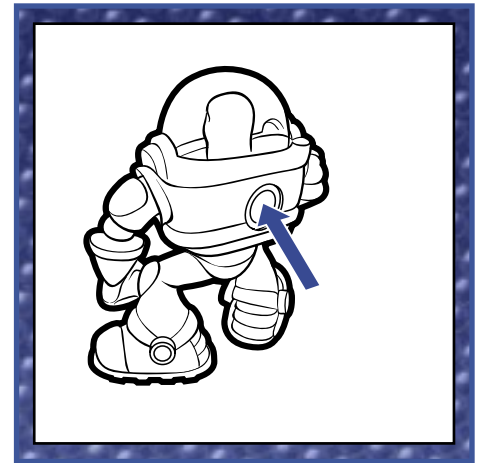

- Buzz Lightyear figure has hole in back to fit backpacks (sold separately).

To replace computer-screen light bulb

Use a Phillips/cross head screwdriver to loosen screw in computer screen base (screw remains attached to base). Remove screen. Remove light bulb and spacer. Replace exhausted bulb with a fresh PR7 or 1.1 watt bulb. Replace door and tighten screw.

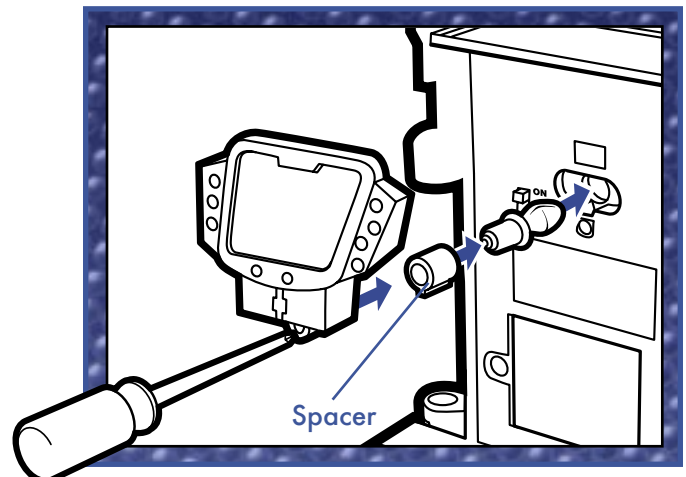

To Replace Batteries

Use a Phillips screwdriver (not included) to loosen screw in battery compartment door (screw remains attached to door). Remove door and remove old batteries. Insert 3 x 1.5V fresh "AA" or R6 size batteries. Alkaline batteries recommended. Replace door and tighten screw.

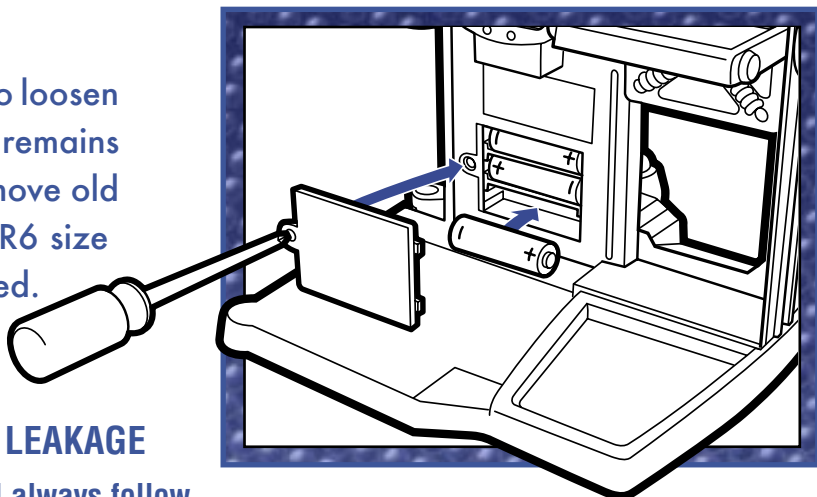

CAUTION: TO AVOID BATTERY LEAKAGE

1. Be sure to insert the batteries correctly and always follow the toy and battery manufacturers' instructions;
2. Do not mix old and new batteries or alkaline, standard (carbon-zinc) or rechargeable (nickel-cadmium) batteries;
3. Always remove weak or dead batteries from the product.

IMPORTANT: BATTERY INFORMATION

Please retain this information for future reference.

Batteries should be replaced by an adult.

CAUTION:

1. Always follow the instructions carefully. Use only batteries specified and be sure to insert them correctly by matching the + and - polarity markings.
2. Do not mix old batteries and new batteries, or standard (carbon-zinc) with alkaline batteries.
3. Remove exhausted or dead batteries from the product.
4. Remove batteries if product is not to be played with for a long time.
5. Do not short-circuit the supply terminals.
6. Should this product cause, or be affected by, local electrical interference, move it away from other electrical equipment. Reset (switching off and back on again or removing and re-inserting batteries) if necessary.
7. **RECHARGEABLE BATTERIES: Do not mix these with any other types of battery. Always remove from the product before recharging. Recharge batteries under adult supervision. DO NOT RECHARGE OTHER TYPES OF BATTERIES.**

FCC STATEMENT

This device complies with part 15 of the FCC Rules. Operation is subject to the following two conditions: (1) This device may not cause harmful interference, and (2) this device must accept any interference received, including any interference that may cause undesired operation. This equipment has been tested and found to comply with the limits for a Class B digital device, pursuant to part 15 of the FCC Rules. These limits are designed to provide reasonable protection against harmful interference in a residential installation. This equipment generates, uses and can radiate radio frequency energy, and, if not installed and used in accordance with the instructions, may cause harmful interference to radio communications. However, there is no guarantee that interference will not occur in a particular installation. If this equipment does cause harmful interference to radio or television reception, which can be determined by turning the equipment off and on, the user is encouraged to try to correct the interference by one or more of the following measures:

- Reorient or relocate the receiving antenna.
- Increase the separation between the equipment and receiver.
- Consult the dealer or an experienced radio/TV technician for help.

© Disney/Pixar

®* and/or ™* & © 2003 Hasbro. All Rights Reserved.

® denotes Reg. U.S. Pat. & TM Office.

03116

P/N 6390320000



Questions? Call: 1-800-327-8264