

# Instructions for Installation and Use

Built-under Electric  
double oven

GB

English, 2

UE89X1  
UQ89I

## Contents

Introduction, 2

Safety Information, 3

The main parts of your Double Oven, 4

Controls, 5-6

The Cooking Modes in your Double Oven, 7

Electronic Clock & Automatic Cooking Feature, 8-10

Solarplus Grill, 11-12

Top Oven - Conventional Cooking, 13

Top Oven Temperature Charts - Meat, 14

Top Oven Temperature Charts - Baking, 15

Main Oven - The Intelligent Cooking System, 16-19

Temperature Conversion Chart, 20

Care and Cleaning, 21-23

Installation, 24-26

If something goes wrong..., 27-28

Guarantee Information, 30

Service Information, 31

GB

# Introduction

GB

## To the Installer:

Before installation, fill in the product details on the back cover of this book.  
The information can be found on the rating plate.

## To the User:

You must read the instructions prior to installing and using the appliance and then retain them for future reference.

! Before operating your new appliance please read this instruction booklet carefully. It contains important information concerning the safe operation, installation and maintenance of the appliance.

! Please keep these operating instructions for future reference. Pass them on to possible new owners of the appliance.

## Retention of this Instruction Book

This Instruction Book must be kept handy for reference as it contains important details on the safe and proper use of the appliance.

If you sell or pass the appliance to someone else, or move house and leave it behind, make sure this Book is also provided so the new owner can become familiar with the appliance and safety warnings.

Your new appliance is guaranteed\* and will give lasting service. This guarantee is only applicable if the appliance has been installed in accordance with the installation instructions detailed in this booklet. To help make best use of your cooking equipment, please read this booklet carefully.  
The appliance is designed specifically for domestic use and responsibility will not be accepted for use in any other installation.

## When the cooker is first used an odour may be emitted, this will cease after a period of use

To help remove the 'new' smell, heat up the empty ovens to maximum temperature for a minimum of two or three hours, keeping the oven doors closed. Ensure that the room is well ventilated (e.g. open a window or use an extractor fan) and that persons who may be sensitive to the odour avoid any fumes. It is suggested that any pets be removed from the room until the smell has ceased.

This odour is due to temporary finish on oven liners and elements and also any moisture absorbed by the insulation.

\* The guarantee is subject to the provisions that the appliance:

- (a) Has been used solely in accordance with the Users Instruction Book.
- (b) Has been properly connected to a suitable supply voltage as stated on the rating plate attached to this equipment.
- (c) Has not been subjected to misuse or accident or been modified or repaired by any person other than the authorised employee or agent.
- (d) Has been correctly installed.



This appliance conforms to the following EEC directives:

### Electromagnetic Compatibility;

- 89/336/EEC
- 92/31/EEC
- 93/68/EEC

### Low Voltage Equipment

- 2006/95/EEC
- 93/68/EEC

---

## Technical Characteristics

---

### Top Oven

Usable Volume: 29 Litres

### ENERGY LABEL - Top Oven

Directive 2002/40/EC on the label of electric ovens  
Norm EN 50304

Declared energy consumption for  
Natural convection Class

heating mode: Conventional

### Main Oven

Usable Volume: 50 Litres

### ENERGY LABEL - Main Oven

Directive 2002/40/EC on the label of electric ovens  
Norm EN 50304

Declared energy consumption for  
Natural convection Class

heating mode: Fan Oven 

### Voltage and Frequency

230-240V~ 50Hz

---

**When used properly your appliance is completely safe but as with any electrical product there are certain precautions that must be observed. PLEASE READ THE PRECAUTIONS BELOW BEFORE USING YOUR APPLIANCE.**

## Always

- Always make sure you remove all packaging and literature from inside the oven and grill compartments before switching on for the first time.
- Always make sure you understand the controls prior to using the appliance.
- Always keep children away from the appliance when in use as the surfaces will get extremely hot during and after cooking.
- Always make sure all controls are turned off when you have finished cooking and when not in use.
- Always stand back when opening an oven door to allow any build up of steam or heat to disperse.
- Always use dry, good quality oven gloves when removing items from the oven/grill.
- Always take care to avoid heat/steam burns when operating the controls.
- Always turn off the electricity supply at the wall switch before cleaning and allow the appliance to cool.
- Always make sure the shelves are in the correct position before switching on the oven.
- Always keep the oven and grill doors closed when the appliance is not in use.
- Always take care when removing utensils from the top oven when the main oven is in use as the contents may be hot.
- Always keep the appliance clean as a build up of grease or fat from cooking can cause a fire.
- Always follow the basic principles of food handling and hygiene to prevent the possibility of bacterial growth.
- Always keep ventilation slots clear of obstructions.
- Always refer servicing to a qualified appliance service engineer.
- During use the oven becomes hot. Care should be taken to avoid touching heating elements inside the oven.

## SAFETY ADVICE

### IN THE EVENT OF A CHIP PAN OR ANY OTHER PAN FIRE:

1. TURN OFF THE COOKER APPLIANCE AT THE WALL SWITCH.

2. COVER THE PAN WITH A FIRE BLANKET OR DAMP CLOTH, this will smother the flames and extinguish the fire.
3. LEAVE THE PAN TO COOL FOR AT LEAST 60 MINUTES BEFORE MOVING IT. Injuries are often caused by picking up a hot pan and rushing outside with it.

## Never

- Never leave children unsupervised where a cooking appliance is installed as all cooking surfaces will be hot during and after use.
- Never allow anyone to sit or stand on any part of the appliance.
- Never store items above the appliance that children may attempt to reach.
- Never remove the oven shelves whilst the oven is hot.
- Never heat up unopened food containers as pressure can build up causing the container to burst.
- Never store chemicals, food stuffs or pressurised containers in or on the appliance, or in cabinets immediately above or next to the appliance.
- Never operate the grill with the door closed as this will cause the appliance to overheat.
- Never use the appliance as a room heater.
- Never use the grill to warm plates.
- Never dry any items on the oven doors.
- Never install the appliance next to curtains or other soft furnishings.
- Never allow children to play with the appliance controls.
- Never use 'steam cleaners'.

This appliance is not intended for use by persons (including children) with reduced physical, sensory or mental capabilities, or lack of experience and knowledge, unless they have been given supervision or instruction concerning use of the appliance by a person responsible for their safety.

Children should be supervised to ensure that they do not play with the appliance.

**!** The appliance should not be operated by people (including children) with reduced physical, sensory or mental capacities, by inexperienced individuals or by anyone who is not familiar with the product. These individuals should, at the very least, be supervised by someone who assumes responsibility for their safety or receive preliminary instructions relating to the operation of the appliance.

# The main parts of your Double Oven

GB

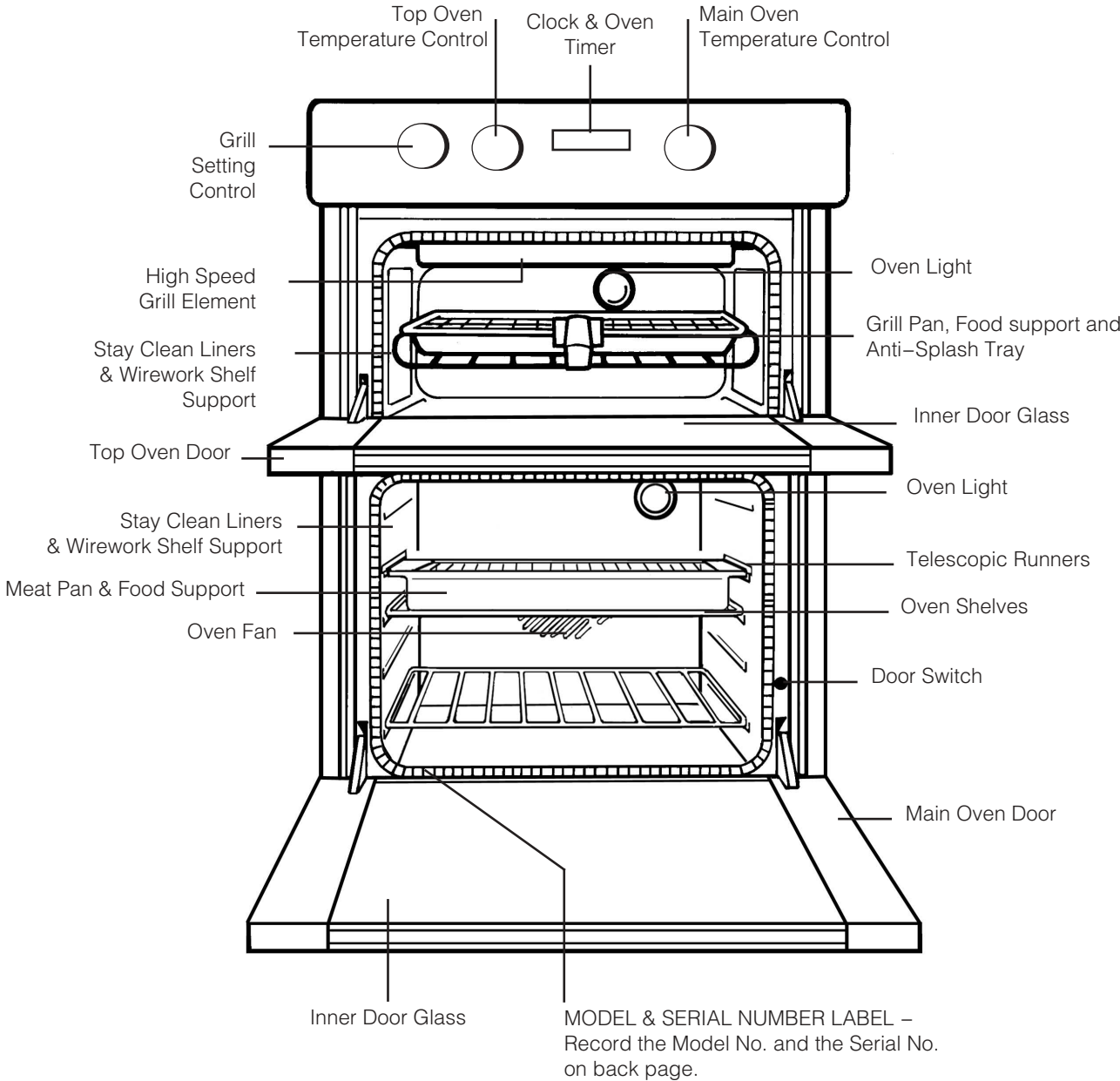

Switch on the electricity supply to your oven at the cooker control unit.

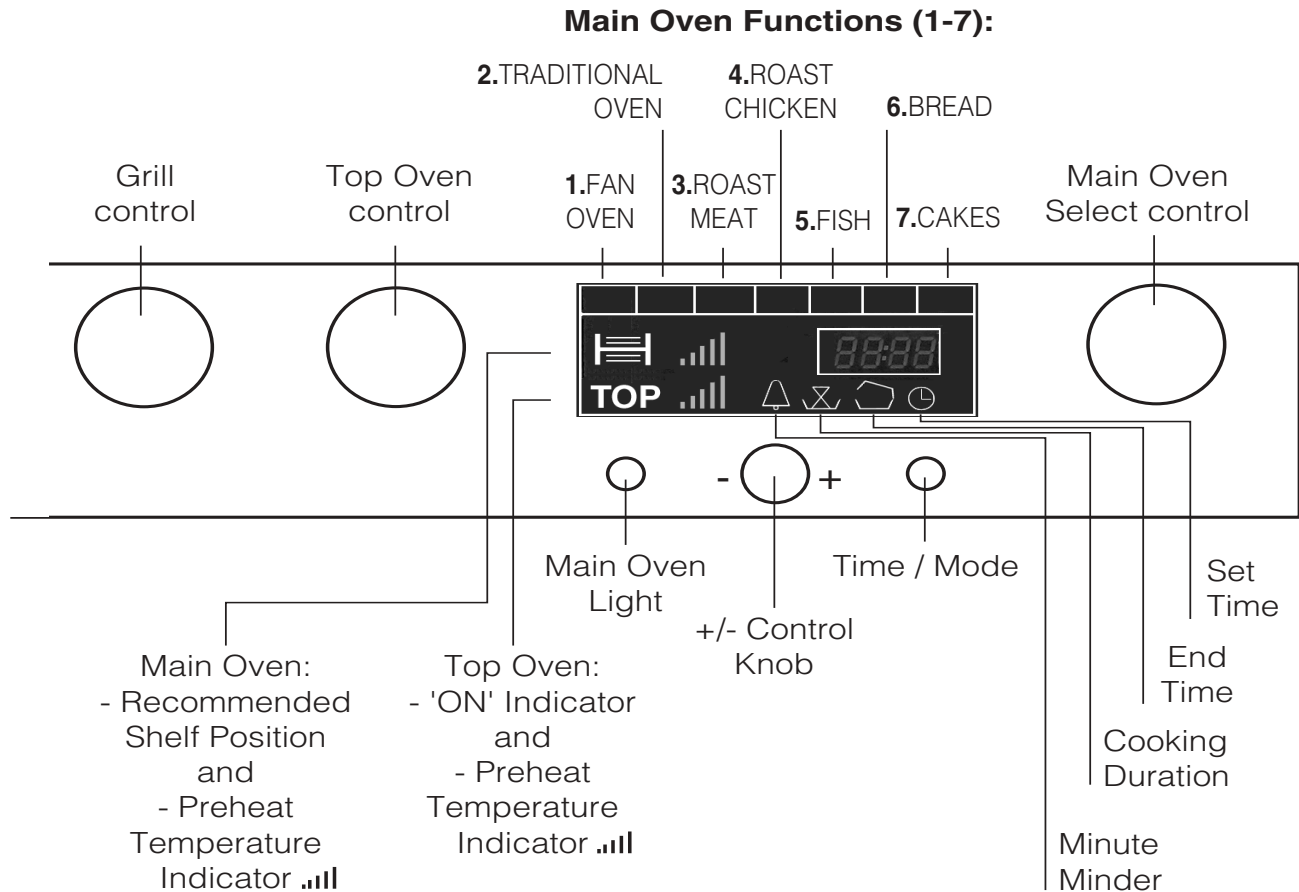

## Grill Control - Top Oven

The grill control will not operate unless the top oven control is in the 'O' off position. The grill control provides fully variable heat control for either the twin grill or single (left hand side) grill by selecting any number between 1 & 4. When turned clockwise the twin grill will be switched on and any power setting from 1 - 4 can be selected. The power level numbers are indicated on the control knob. When turned anti-clockwise the single grill will be switched on and any power setting from 1 - 4 can be selected. The power level numbers are indicated on the control knob. The off position is identified by an 'O'.

## Top Oven Control

This control switches on the top and bottom heating elements in the top oven. The temperature in the oven can be set anywhere between 100°C and 220°C. The top oven ON indicator (TOP) and the top oven preheat temperature indicator (.,.,. symbol) will be on the display (bottom left hand corner). The top oven preheat temperature indicator (.,.,. symbol) will switch OFF and an audible tone will sound when the top oven has reached the required temperature. When in operation the oven light will be illuminated. The off position is identified by an 'O'.

## Notes

If both the top oven and grill controls are turned on together, the (TOP) and (.,.,. symbol) will flash on the display. The cooker will continue to operate in the function which was selected first.

# The controls

---

GB

## Main Oven Control

This control switches on the top and rear heating elements at various times in the main oven, dependent on which mode has been set.

The temperature of the main oven can be set anywhere between 80°C and 230°C in cooking modes 1 - 5.

The main oven preheat temperature indicator (.,||| symbol) will be on the display (middle, left hand side).

The main oven preheat temperature indicator (.,||| symbol) will switch OFF and an audible tone will sound when the main oven has reached the required temperature.

## The Main Oven Cooking Functions

The main oven has eight cooking functions. Use the main oven control to select the cooking mode you require. The display will show the function you have selected, across the top (1 - 7) with the eighth function being shown on the clock display as '(RISE)'.

## Adjusting the Main Oven Temperature

When a program is set (position 1 - 5), the display will automatically suggest a cooking temperature. If you wish you can use the +/- control knob to change the suggested temperature to one of your own choice, within a range which is suitable for the particular cooking mode.

## Main Oven Light

The main oven light can be switched on, when the oven is not in use, by pressing the oven light button on the display. The oven light will also operate whenever the main oven door is opened.

**NOTE: The oven light can be switched off when the door is opened by pressing the oven light button on the display, or by closing the door.**

## Cooling Fan

The cooling fan operates with the ovens and grill. The fan will operate at full speed for a few seconds and then reduce to a lower speed. The cooling fan will only increase to full speed if the temperature inside the cooker reaches above a certain limit.

# The Cooking Modes in your Oven

Your new appliance is equipped with a number of different cooking modes:



## Conventional Heating (Top Oven)

- with upper and lower heat. This system is particularly suitable for roasting and baking on one shelf only.



## Variable Grilling (Top Oven)

- the oven can also be used for conventional grilling with a full or half width fully controllable grill.

Note: The Top Oven door should be open when grilling.



## Fan Oven (Main Oven)

- the fan oven operates by constantly blowing heated air, from an element wrapped around the fan, into the oven. This gives improved efficiency and in general, enables the use of lower temperatures for cooking. It also means that there is less need to be particular about shelf positions and that you can bake at more than one level simultaneously (Batch Baking).



## Traditional (Main Oven)

- the upper and rear heating elements are switched on in this position. The traditional oven brings an outstanding level of temperature distribution and reduced consumption. In traditional cooking use only one rack to ensure good heat distribution. By using the various shelf positions available you can balance the quantity of heat between the upper and lower part. If cooking requires more heat from below or above, use the lower or higher shelves respectively.



## Roast Meat (Main Oven)

- specially created for cooking joints of meat. This mode raises the temperature in the oven to a very high heat for the first part of the cooking cycle, to seal the outside of the joint and retain the juices of the meat throughout cooking. After this the temperature is reduced to the set temperature using each heating element in turn to guarantee a homogeneous temperature for the cooking period. A temperature is suggested on this mode but this can be altered using the '+/-' control knob.



## Roast Chicken (Main Oven)

- specially created for cooking excellent roast poultry. This mode can be used to roast chickens, duck, turkey and other poultry to perfection. Each heating element is used in the cycle to guarantee a homogeneous temperature within the oven. A temperature is suggested on this mode but this can be altered using the '+/-' control knob.



## Fish (Main Oven)

- this mode provides gently pulsing top and rear heat to lightly poach fish dishes without overcooking or drying out. A temperature is suggested on this mode but this can be altered using the '+/-' control knob.



## Rising (Main Oven)

- this mode heats and holds the oven at 40°C. It is ideal for proving bread and yeast based dough mixtures. When this mode is selected a cooking duration of 14 minutes is automatically set, this can be altered by pressing the 'time/mode' button until the cooking duration icon flashes. Then use the '+/-' control knob to adjust the cooking duration.



## Bread cycle - Auto

- this mode is fully automatic and lasts for 1 hour. When this mode is selected the time and temperature cannot be adjusted. It is suitable for baking bread weighing up to 1.5kg, either in a tin or on a baking tray. This mode includes a proving cycle and a baking cycle. If an initial proving cycle is needed this can be done using the RISE mode (8). Some recipe ideas are included in the recipe book supplied with the cooker.



## Cake cycle - Auto

- this mode is fully automatic and lasts for 1 hour. When this mode is selected the time and temperature cannot be adjusted. It is suitable for baking sponge based cakes that take between 30 minutes and 1 hour to cook. Some recipe ideas are included in the recipe book supplied with the cooker.

# Electronic Clock & Automatic Cooking Feature

GB

When you first switch on the appliance you will be prompted to set the 'Time of Day' on the display. You must ensure you have done this before attempting to use the automatic cooking feature.

## AUTOMATIC COOKING

The main oven can be controlled automatically.

## HINTS ON AUTOMATIC COOKING

- Select food which will require the same cooking time and temperature.
- To ensure food does not cool down and require reheating, set the end time so the food is ready when you require it.
- Always ensure that meat and poultry is defrosted before placing in the oven.
- Whenever possible, take food out of the refrigerator and keep it as cool as possible.
- If cooking food that requires frying before placing in the oven for automatic cooking, keep the delay time to a minimum.
- Never place hot or warm food in the oven for delayed start cooking as it could cause the oven to be warm and produce harmful bacteria in the food.
- We advise that dishes containing left-over cooked poultry and meat, eg. shepherds pie, should not be cooked automatically if there is to be a delay period.
- Ensure that delay start times are kept to a minimum to prevent bacterial growth in food.
- Wine or beer may ferment and cream may curdle during the delay period, so it is best to add these ingredients just before serving.
- Foods which discolour should be protected by coating in fat or tossing in water to which lemon juice has been added, prior to placing food in the oven.
- Dishes containing liquid should not be filled too full to prevent boiling over.
- Food should be well sealed (but not airtight) in a container to prevent the loss of liquid during cooking. Aluminium foil gives a good seal.
- Always ensure that food is piping hot and cooked thoroughly before serving.
- Only reheat food once.

## SETTING THE TIME OF DAY:

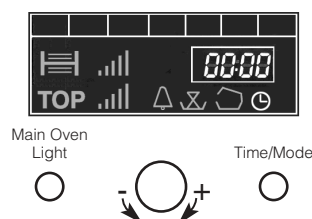

- STEP 1. Check the electricity supply to the cooker is turned on.
- STEP 2. When switched on the display will show both 00:00 and the 'set time' symbol flashing. Wait until these stop flashing.
- STEP 3. Press the Time/Mode button once, so that the 'Set Time' symbol and the display are flashing. Turn the +/- control knob until the correct hour is set.
- STEP 4. Press the Time/Mode button once, so that the 'Set Time' symbol and the display are flashing. Turn the +/- control knob until the correct minutes are set. Press the Time/Mode button again.

## TIME OF DAY IS NOW SET.

To alter the time of day after the first setting, simply press the Time/Mode button. The 'Set Time' symbol and the display will flash. Repeat STEPS 3 and 4.

## SETTING THE MINUTE MINDER:

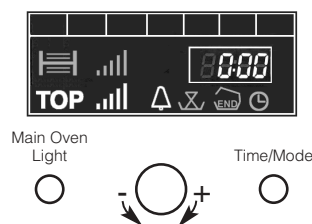

- STEP 1. Press the Time/Mode button, until the 'bell' symbol is flashing.
- STEP 2. Turn the +/- control knob to set the duration in minute increments until the required time is set. After a few seconds the 'bell' symbol will stop flashing and the time will count down.

## THE MINUTE MINDER IS NOW SET.

At the end of the set time an audible tone will be heard and the 'bell' symbol will go out. After a few seconds the audible tone will stop and after a few seconds the display will revert back to the time of day.



# Electronic Clock & Automatic Cooking Feature

 Hotpoint

GB

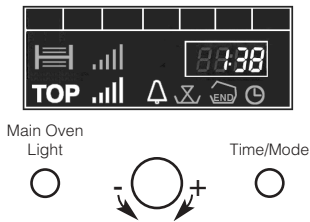

The minute minder can be cancelled at any time by following STEPS 1 and 2, setting the time period to zero using the +/- control knob. The display will revert back to the time of day.

The display shows HOURS and MINUTES eg. 1 hour 38 minutes

## AUTO COOKING TIMER

There are two Auto Cooking programmes for the main oven, that can be selected using the display:

- To set the main oven to switch ON immediately and OFF automatically after a time of your choice.
- To set the main oven to switch ON and OFF automatically, at the times of your choice.

### (a) To set the main oven to switch ON immediately and OFF automatically:

*This allows you to cook for a specified duration, after which the oven will automatically switch off.*

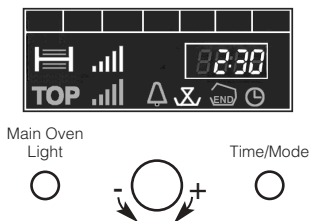

- STEP 1. Check that the correct time of day is set, if not follow instructions for setting the time of day.
- STEP 2. Place food to be cooked on shelf in the oven.
- STEP 3. Switch the main oven control to the desired mode. The display will automatically suggest a cooking temperature. This can be changed by turning the +/- control knob. (The oven will start).
- STEP 4. Press the Time/Mode button, until the 'cooking duration' symbol is flashing.

- STEP 5. Turn the +/- control knob to set the cooking duration you require. After a few seconds the 'cooking duration' symbol will stop flashing and the display will show the temperature that has been set. This will change every few seconds when the display will show the cooking duration remaining.

### THE COOKING DURATION IS NOW SET.

At the end of the set cooking duration, 'End' will show in the display and an audible tone will be heard for a few seconds.

Turn the main oven control to 'O', the OFF position to switch the oven off. The display will revert back to the time of day.

To cancel the automatic mode at any time turn the main oven control to 'O', the OFF position.

**Note: During the cooking period the cooking duration will be shown in the display for a few seconds and then revert to the temperature set.**

### (b) To set the main oven to switch ON and OFF immediately:

*This allows you to cook for a specified duration and additionally choose the time you wish the cooking cycle to finish. From this information the system works out when the cooking cycle will need to start and automatically switches the oven on at the required time.*

- Follow STEPS 1 to 5 in the previous section (a) entitled: 'To set the main oven to switch ON immediately and OFF automatically', then continue as below:

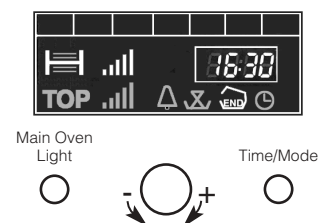

- STEP 6. Press the Time/Mode button, until the 'end time' symbol is flashing. The display will show a default cooking end time (this will be the current time plus the cooking duration you set in STEP 5). The 'end time' symbol will flash.

# Electronic Clock & Automatic Cooking Feature

GB

STEP 7. Turn the +/- control knob to set the time you wish the cooking to end. After a few seconds the display the temperature, cooking duration and end time in turn.

## THE COOKING DURATION AND END TIME IS NOW SET.

The display will show the temperature and cooking duration when the programme has started.

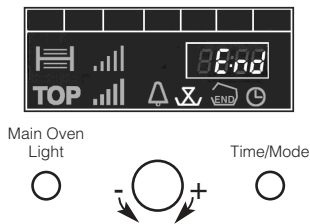

At the end of the cooking duration, 'End' and the 'cooking duration' symbol will show in the display and an audible tone will be heard for a few seconds.

Turn the main oven control to 'O', the OFF position to switch the oven off. The display will revert back to the time of day.

To cancel the automatic mode at any time turn the main oven control to 'O', the OFF position.

**Note: At any time up to the start of cooking, the cooking end time, cooking duration and the temperature will be shown in the display.**

**CAUTION: Accessible parts may become hot when the grill is in use - children should be kept away.**

Your cooker is not fitted with a conventional type of grill. The **solarplus** grill is designed to reduce your grilling times. It is quicker because it takes less time to warm up from cold. Conventional grills require 5 minutes pre-heat before food is placed beneath them, but for normal grilling the **solarplus** grill can be used from cold without any pre-heat. However, when toasting, optimum performance is achieved by pre-heating the grill for about 1 minute.

**Notes**

You will notice that the grill elements are protected by a wire mesh.

This stops you from touching live parts.

**DO NOT under any circumstances insert objects into the grill mesh as this could damage or break the element tubes OR if the grill is on cause an electric shock.**

During use the mesh may become soiled. Do not attempt to clean it while the grill is still on. Turn the cooker off at the control unit and wait until it has cooled down before cleaning.

Care must be taken to ensure the grill mesh is not distorted - DO NOT store the grill pan handle on the grill pan grid when the grill pan runners are on the top runner position.

There are two halves to the grill, one on the left and one on the right. You can choose to have both sides on or just the left side on.

Turning the control knob clockwise, will switch both sides on. Turning it anti-clockwise, will only switch the left side on.

The numbers which are displayed indicate the heat setting:

**MAXXIMUM** is the hottest and **MINIMUM** the coolest.

**GRILLING SHOULD NOT BE UNDERTAKEN WITH THE TOP OVEN/GRILL DOOR CLOSED**

**- This will cause overheating.**

The grill will not operate unless the top oven control is in the Off position, 'O'.

To operate the grill proceed as follows:

1. Open the grill/top oven door fully.
2. Position the rod shelf as recommended, in the chart (next page), for the food being cooked.
3. Place the grill pan on the rod shelf, ensuring it is positioned centrally under the element.
4. Never line the grill pan with aluminium foil as this may cause overheating of fat in the grill pan.

Food	Pre-heat	Shelf Position from base of oven	Setting	Approx. Cooking Time	Comments
Toasting of Bread Products	1 min.	5	Maximum	3-5 minutes. Grill pan and grid.	<b>NOTE:</b> There are 5 Shelf positions. Position 1 is bottom runner from the base of the oven.
Small cuts of meat – Sausages, Bacon	None	3 or 4	Maximum for 4 minutes, then reduce to 3	10-15 minutes. Grill pan and grid.	
Chops, etc. Gammon Steaks, Chicken pieces	None	3	Maximum for 6-8 minutes, then reduce to a lower setting	25-30 minutes. Grill pan and grid.	
Fish	Whole:	3	Maximum	6-8 minutes. In base of grill pan.	
	Filletts:	3 or 4	Maximum		
Fish in breadcrumbs	None	3 or 4	Maximum	10-15 minutes. Grill pan and grid.	
Pre-cooked Potato Products	None	3 or 4	Maximum	10-12 minutes.	
Pizzas	None	3 or 4	Maximum	10-15 minutes. Grill pan and grid.	
Browning of Food	1 min.	1 or 2	Maximum	5-7 minutes. Dish placed directly on shelf.	

### Grill Pan Handle

The grill pan handle is detachable from the pan, to facilitate cleaning and storage. The handle can be either detachable from OR fixed to the pan.

#### For a fixed handle:

Remove the screw and washers from the grill pan bracket, tilt the handle over the recess adjacent to the bracket (A), slide it towards the centre of the pan (B) and let the handle locate over the bracket (C). Replace the screw and washers and ensure they are fully tightened up.

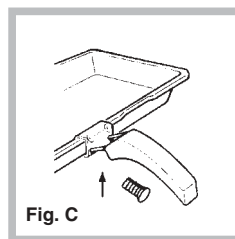
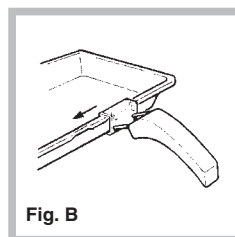
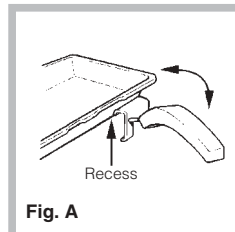

#### For a detachable handle:

Remove the screw and washers from the grill pan and keep safe.

Please note: If a fixed handle is required, the grill pan cannot be kept in the Fan Oven with the door closed but may be stored in the top oven.

**WARNING: Ensure that when using the grill pan handle in the detachable manner, it is centralised and secure.**

# Top Oven - Conventional Cooking

The heat for conventional cooking in the top oven is provided by the grill element and the element under the floor of the oven. It is ideal for the slow cooking of cheaper cuts of meat in casseroles etc. but can also be used for small joints of meat up to 1.5kg (3lb). The operation of the controls is covered on "The Controls".

See cooking charts for temperatures and shelf positioning.

The top oven can be used either independently to cook small quantities of food or in conjunction with the main oven to provide additional cooking space.

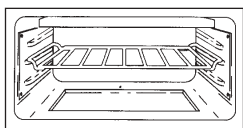

- The shelf should be positioned on the first or second runner from the bottom.

#### To use the oven proceed as follows:

- Set the top oven control to the required temperature, the top oven light will come on and wait for the thermostat light to go off, indicating that the oven has reached the right temperature.
- The food to be cooked should be placed in the centre of the shelf with a gap of at least 25mm (1in) between it and the grill element. This should avoid burning and ensure even cooking.

- **Do not place food or dishes on the floor of the oven.**

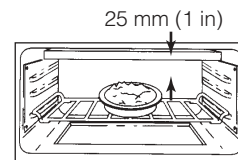

#### Platwarming in the top oven

Plates and dishes placed on shelf 1 of the top oven will be heated when the main oven is in use.

When the main oven is not in use, for instance when a meal is being cooked on the hob, place the plates and serving dishes on the shelf using the bottom runner and turn the top oven control to approximately 100°C. A maximum time of 10-12 minutes is all that is required to heat the plates and dishes.

NEVER operate the grill control when using the top oven for cooking or warming plates and dishes.

**WARNING: DO NOT put delicate items china or items which could be affected by heat into the oven.**

# Top Oven Temperature Charts - Meat

GB

Meat	Pre-heat	Temperature °C	Time (approx.)	Position in Oven
Beef/ Lamb (slow roasting)	Yes	170/180	35 mins per 450g (1lb) + 35 mins over.	Runner 1 from bottom of oven.
Beef/ Lamb (foil covered)	Yes	190/200	35-40 mins per 450g (1lb)	
Pork (slow roasting)	Yes	170/180	40 mins per 450g (1lb) + 40 mins over	
Pork (foil covered)	Yes	190/200	40 mins per 450g (1lb)	
Veal (slow roasting)	Yes	170/180	40-45 mins per 450g (1lb) + 40 mins over	
Veal (foil covered)	Yes	190/200	40-45 mins per 450g (1lb)	
Poultry/Game (slow roasting)	Yes	170/180	25-30 mins per 450g (1lb) + 25 mins over	
Poultry/Game (foil covered)	Yes	190/200	25-30 mins per 450g (1lb)	
Casserole	Yes	150	2-2 1/2 hrs	

## If using aluminium foil, never:

1. Allow foil to touch sides of oven.
2. Cover oven interior with foil.
3. Cover shelves with foil.

The most accurate method of testing the readiness of joints of meat or whole poultry is to insert a meat thermometer into the thickest part of a joint, or the thickest part of poultry thighs, during the cooking period. The meat thermometer will indicate when the required internal temp has been reached.

Beef -	Rare:	60°C	Lamb:	80°C	Poultry:	90°C
	Medium:	70°C	Pork:	80°C		
	Well Done:	75°C	Veal:	75°C		

# Top Oven Temperature Charts - Baking



GB

Food	Pre-heat	Temperature °C	Time in mins.	Position in Oven
Scones	Yes	210/220	10-15	Runner 2 from bottom of oven.
Small Cakes	Yes	180/190	20-25	Runner 2 from bottom of oven.
Victoria Sandwich	Yes	170/180	20-30	Runner 2 from bottom of oven.
Sponge Sandwich (fatless)	Yes	180/190	20-25	Runner 2 from bottom of oven.
Swiss Roll	Yes	200/210	10-15	Runner 2 from bottom of oven.
Semi-rich Fruit cakes	Yes	150/160	60-75 7 inch	Runner 1 from bottom of oven.
Rich Fruit cakes)	Yes	140/150	Time Dependent on size	Runner 1 from bottom of oven.
Shortcrust Pastry	Yes	190/200	Time Dependent on recipe	Runner 1 or 2 from bottom of oven.
Puff Pastry	Yes	200/210	Time Dependent on recipe	Runner 1 from bottom of oven.
Yorkshire Pudding	Yes	190/200	30-40	Runner 1 or 2 from bottom of oven.
Individual Yorkshire Puddings	Yes	200/210	20-30	Runner 2 from bottom of oven.
Milk Pudding	Yes	140/150	90-120	Runner 1 from bottom of oven.
Baked Custard	Yes	150/160	40-50	Runner 1 from bottom of oven.
Bread	Yes	200/210	30-45	Runner 1 from bottom of oven.
Meringues	Yes	100	150-180	Runner 2 from bottom of oven.

Note: If soft margarine is used for cake making, temperatures recommended by the manufacturers should be followed. Temperatures recommended in this chart refer to cakes made with block margarine only.

# Main Oven - The Intelligent Cooking System

GB

The main oven of your new cooker is equipped with an intelligent electronic cooking system that gives you additional cooking performance, flexibility and features over traditional cooking products. The operation of the controls is covered on "the controls". See cooking charts for temperatures and shelf positioning.

## Cooking temperature ranges

The intelligent cooking system will automatically suggest a suitable cooking temperature for several cooking modes. It is possible however to modify the suggested temperature within a range specific to each cooking mode.

<b>User adjustable temperature ranges by cooking mode:</b>			
<b>Mode</b>	<b>Minimum</b>	<b>Back Left</b>	<b>Maximum</b>
Fan oven	200°C	80°C	230°C
Traditional	190°C	80°C	230°C
Roast meat	160°C	80°C	230°C
Roast chicken	190°C	80°C	230°C
Fish	180°C	80°C	230°C

## Telescopic runners and Meat pan

The main oven on this cooker comes equipped with telescopic runners, meat pan and a food support. The meat pan is suitable for cooking joints of meat and poultry using the intelligent cooking system (Fan, Traditional, Roast Meat and Roast Chicken). Use the information given in the 'Cook Charts' for the shelf positioning of the pan and runners. To reposition the telescopic runners unclip the runners from position, move them to the position you require and re-clip them to secure.

## Cook charts

All times and temperatures can be adjusted to suit personal taste. The information in the following charts is only a guide.



# Main Oven - The Intelligent Cooking System



GB

COOK CHART - Fan oven mode: 			
Meat	Pre-heat	Temperature	Cooking Time
Beef	No	160/180°C	20-25 minutes per 450g (1lb) + 20 minutes extra
Lamb	No	160/180°C	25 minutes per 450g (1lb) + 25 minutes extra
Pork	No	160/180°C	25 minutes per 450g (1lb) + 25 minutes extra
Chicken/Turkey (up to 4kg/8lb)	No	160/180°C	18-20 minutes per 450g (1lb) + 20 minutes extra
Turkey (4-5.5kg/8-12lb)	No	150/160°C	12-14 minutes per 450g (1lb) + 15 minutes extra
<b>Notes:</b> Internal Temperatures:			
	Beef	rare	60°C
		medium	70°C
		well done	75°C
	Lamb		80°C
	Pork		80°C
	Poultry		90°C
BAKING	Preheat	Temperature	Cooking Time
Scones	yes	210/220°C	10-15 minutes
Small cakes	no	170/180°C	15-25 minutes
Victoria sandwich	no	160/170°C	20-30 minutes
Fatless sponge sandwich	yes	180/190°C	10-20 minutes
Swiss roll	yes	190/200°C	10-15 minutes
Semi rich fruit cake	no	140/145°C	60-75 minutes
Rich fruit cake	no	130/140°C	depending on size
Shortcrust pastry	no	190/200°C	depending on recipe
Puff pastry	no	190/200°C	depending on recipe
Yorkshire pudding	yes	180/190°C	30-45 minutes
Yorkshire pudding: Individual	yes	190/200°C	20-25 minutes
Bread	yes	200/210°C	30-45 minutes
Meringues	no	80/90°C	180-240 minutes
<b>Notes:</b> Use up to 2 shelves when cooking (ensure they are evenly spaced) It is not necessary to preheat the oven for some items.			

# Main Oven - The Intelligent Cooking System

GB

COOK CHART - Traditional mode: <input type="checkbox"/>				
Meat	Pre-heat	Temperature	Shelf Position	Cooking Time
Beef	yes	190/200°C	2 or 3	20-25 minutes per 450g (1lb) + 20 minutes extra
Beef (foil covered)	yes	190/200°C	2 or 3	35-45 minutes per 450g (1lb)
Lamb	yes	190/200°C	2 or 3	25-30 minutes per 450g (1lb) + 25 minutes extra
Lamb (foil covered)	yes	190/200°C	2 or 3	35-45 minutes per 450g (1lb)
Pork	yes	190/200°C	2 or 3	30-35 minutes per 450g (1lb) + 30 minutes extra
Pork (foil covered)	yes	190/200°C	2 or 3	40 minutes per 450g (1lb)
Poultry	yes	190/200°C	2 or 3	20-25 minutes per 450g (1lb) + 20 minutes extra
Poultry (foil covered)	yes	190/200°C	2 or 3	25-30 minutes per 450g (1lb)
<b>Notes:</b> Internal Temperatures:				
	Beef	rare		60°C
		medium		70°C
		well done		75°C
	Lamb			80°C
	Pork			80°C
	Poultry			90°C
BAKING	Preheat	Temperature		Cooking Time
Scones	yes	220°C	3	10-15 minutes
Small cakes	yes	180/190°C	3	15-25 minutes
Victoria sandwich	yes	170/180°C	3	20-30 minutes
Fatless sponge sandwich	yes	190/200°C	3	15-20 minutes
Swiss roll	yes	200/210°C	3	10-15 minutes
Semi rich fruit cake	yes	150/160°C	2	60-75 minutes
Rich fruit cake	yes	130/140°C	2	depending on size
Shortcrust pastry	yes	190/200°C	2 or 3	depending on recipe
Puff pastry	yes	190/200°C	2 or 3	depending on recipe
Yorkshire pudding	yes	190/200°C	3	35-45 minutes
Yorkshire pudding:				
Individual	yes	200/210°C	3	20-30 minutes
Bread	yes	200/210°C	3	30-45 minutes
Meringues	yes	80/90°C	3	180-240 minutes
<b>Notes:</b> For best results use one shelf. Preheat the oven before use.				

# Main Oven - The Intelligent Cooking System



GB

COOK CHART - Roast Chicken mode: 				
Meat	Pre-heat	Temperature	Shelf Position	Cooking Time
Chicken	no	170°C	2 or 3	20 minutes per 450g (1lb)
Turkey	no	170°C	2 or 3	15-20 minutes per 450g (1lb)
<b>Notes:</b> Internal Temperatures:				
Poultry 90°C				
If the poultry is covered with foil, the cooking time will need to be extended.				

COOK CHART - Roast Meat mode: 				
Meat	Pre-heat	Temperature	Shelf Position	Cooking Time
Beef	no	170°C	2 or 3	20-25 minutes per 450g (1lb) + 20 minutes extra
Lamb	no	170°C	2 or 3	25 minutes per 450g (1lb) + 25 minutes extra
Pork	no	170°C	2 or 3	25 minutes per 450g (1lb) + 25 minutes extra
<b>Notes:</b> Internal Temperatures:				
	Beef	rare	60°C	
		medium	70°C	
		well done	75°C	
	Lamb		80°C	
	Pork		80°C	
If the meat is covered with foil, the cooking time will need to be extended..				

COOK CHART - Fish mode: 				
FISH	Pre-heat	Temperature	Shelf Position	Cooking Time
Fish steaks (open roasted)	yes	170°C	3	15-25 minutes
Whole fish (foil baked)	yes	180°C	2 or 3	20-25 minutes per 450g (1lb)
Whole stuffed fish (foil baked)	yes	180°C	2 or 3	25-30 minutes per 450g (1lb)

# Temperature Conversion Chart

GB

<b>Gas Mark</b>	<b>°F</b>	<b>Main Conventional Oven</b>	<b>Main Fan Oven</b>
1/2	250	120	100
1	275	140	120
2	300	150	130
3	325	160	140
4	350	180	160
5	375	190	170
6	400	200	180
7	425	220	200
8	450	-	210
9	475	-	220

**Warning: Before cleaning, please ensure that the electricity supply to the appliance is switched off and the appliance is fully cold.**

**! Never use steam cleaners or pressure cleaners on the appliance.**

! Clean the glass part of the oven door using a sponge and a non-abrasive cleaning product, then dry thoroughly with a soft cloth. Do not use rough abrasive material or sharp metal scrapers as these could scratch the surface and cause the glass to crack.

! The accessories can be washed like everyday crockery (even in your dishwasher).

## 1. "STAYCLEAN" OVEN LINERS (Top Oven Sides, Main Oven Sides and Rear Panel)

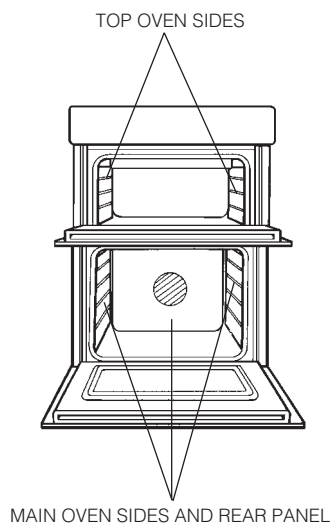

### (a) How "Stayclean" works.

The surfaces of the "Stayclean" oven liners (Main Oven rear panel) are treated with a special vitreous enamel which absorbs cooking soils. At temperatures of 220°C (425°F) or above, the special surface enables these soils to be slowly destroyed. The higher the temperature the more effective it is.

### (b) Cleaning.

In most cases normal cooking operations at 220°C (425°F) will permit this cleaning operation to proceed during cooking. However if higher cooking temperatures are not used regularly, it may be necessary, in order to prevent heavy soiling, to run the ovens without shelves or meat pan, at a maximum setting for a couple of hours (Fan Oven mode only).

It should not normally be necessary to clean the "Stayclean" panels with water. If the user feels it is desirable to do so, wipe them over with a clean, soapy cloth, followed by a wipe with a clean damp cloth.

**DO NOT use biological washing powder, harsh abrasives or chemical oven cleaners of any kind as this could damage the "Stayclean" oven liners.**

## 2. CLEANING GRILL, TOP OVEN AND MAIN OVEN

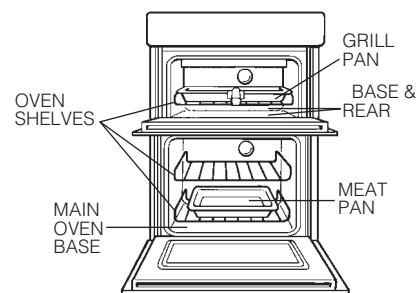

### (a) Base & Rear of Top Oven and Base of Main Oven.

Wipe out the oven with a damp soapy cloth. For more stubborn stains on the base of the oven use a well soaped fine steel wool soap pad.

### (b) Grill Pan, Meat Pan & Oven Shelves.

To prevent stains from being burnt on to the grill pan, food support and rod shelf, always wash immediately after use in warm soapy water. Use a well soaped fine steel wool soap pad to remove stubborn stains from the rod shelves, grill pan, meat pan and the base of the oven.

**DO NOT use aerosol cleaners on this oven as they could adversely affect the fan motor unit, and cannot be wiped off the fan blade.**

### (c) Solarplus Grill.

To clean the Solarplus Grill, use a clean, damp, soapy cloth and wipe over. If stubborn stains remain, gently clean with a well soaped nylon scouring pad and wipe over with a damp cloth.

**DO NOT use metal cleaning utensils, wire wool or proprietary oven cleaners on the grill element mesh.**

# Care and Cleaning

GB

## 3. OVEN DOORS

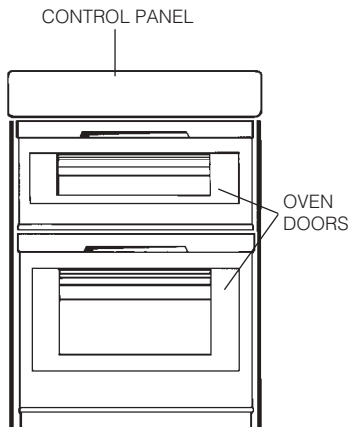

### (a) Control Panel

Regularly wipe with a clean, damp cloth and polish with a clean, dry cloth.

### (b) Inner Door Panels & Glass

Open the door fully. The glass panel may now be washed. Stubborn stains can be removed by using a well soaped, fine steel wool soap pad.

### (c) Stainless trims (UE89X1)

Regularly wipe with a clean, damp cloth and polish with a clean dry cloth.

**DO NOT use scouring pads, or abrasive powder, which will scratch the glass.**

## 4. REPLACEMENT OF THE OVEN LAMP

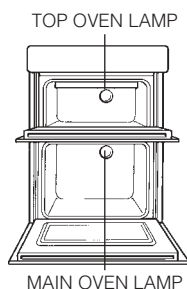

**Warning: To avoid electric shocks - please ensure that the electricity supply to the appliance is switched off and the appliance is fully cold, before removing the lamp lens.**

Open the oven door and remove the oven shelves. Using a thick cloth, grip the lamp lens, unscrew anticlockwise and remove the lens. Carefully unscrew the bulb anti-clockwise. Fit replacement bulb (25W 300°C SES) and refit lens.

## 5. HOW TO CLEAN THE LAMP LENS

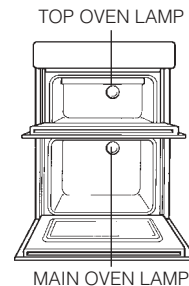

**Warning: To avoid electric shocks - please ensure that the electricity supply to the appliance is switched off and the appliance is fully cold, before cleaning lamp lens.**

Open the oven door and remove the oven shelves. Using a thick cloth, grip the lamp lens, unscrew anticlockwise and remove. Clean with a non-abrasive cleansing cream and refit lamp lens.

**DO NOT use scouring pads, or abrasive powder, which will scratch the glass lens**

## CLEANING THE DOORS

**Take particular care not to damage the inner surface of the door inner glass that is coated with a heat reflective layer. Do not use scouring pads, or abrasive powder, which will scratch the glass. Ensure that the glass panel is not subjected to any sharp mechanical blows.**

Stubborn stains can be removed by using a fine steel wool soap pad. For slight soiling the inner glass panel may be cleaned, while still warm, without removing it from the door. After cleaning, rinse and dry with a soft cloth.

## DROP DOWN DOORS

**Remove the door inner glass as follows.**

1. Open the door fully and remove the extrusion end caps (This should be done by hand but if it proves too difficult, simply lift the inner glass to ease the end caps out of position).

NOTE: If you need to use a tool - be careful not to damage the extrusion or end cap.

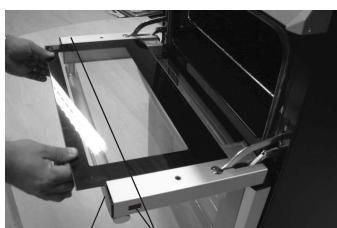

Top filler cap    Remove both screws to remove top filler cap

2. Carefully slide the inner glass towards you and withdraw it from its locating slots. Ensure that the door is not allowed to slam shut, due to the reduction in door weight. Clean the glass as described above.
3. The inside of the outer door glass can now be cleaned while still fitted to the cooker.

**NEVER OPERATE THE COOKER WITHOUT THE INNER DOOR GLASS IN POSITION.**

**Refit the door inner glass as follows.**

1. Open the door fully.
2. Locate the inner door glass into its slots. The inner door glass has a special reflective coating on one side, in order to minimise surface temperatures and energy consumption during use, it is important it is fitted correctly.
3. Carefully slide the glass into its slots as far as it will go and replace the top filler cap.

# Installation

GB

## Electrical Requirements

For your own safety, we recommend that your cooker is installed by a competent person such as one who is registered with NICEIC (National Inspection Council for Electrical Installation Contracting). The cooker should be installed in accordance with the latest edition of the IEE Regulations.

**Warning: This appliance must be earthed.**

## Electrical Connections

The installer must check that the voltage shown on the rating plate corresponds with the house electricity supply. The cooker must be supplied via a suitable double pole isolating switch, having a contact separation of at least 3mm in all poles placed in a readily accessible position adjacent to the cooker. If the cooker is to be wired into a connector unit, this may be positioned behind the cooker providing the following requirements are met:

- The connector unit must not project from the wall more than 25mm.
- The top of the connector must not be more than 130mm above floor level.

Remove the terminal cover at the rear base of the cooker. Pass the cable through the cable clamp and connect to the appropriate terminals provided. Allow sufficient cable for any future servicing. Tighten the screws on the cable clamp and replace the cover. Make main connections in the connector unit or cooker control unit. This appliance conforms to B.S. EN 55014 regarding suppression of Radio and Television reception interference.

A double Pole control switch having a minimum rating of 32 amps should be used to feed the cooker using a suitably rated cable. Where a hob is fitted adjacent to or over the cooker, a 45 amp Double Pole control switch should be used to feed both units via separate suitably rated cables.

We recommend a minimum of 4mm<sup>2</sup> PVC insulated twin and earth cable conforming to B.S. 6004 for connection of each appliance.

**In all cases adhere to routing details (see fig. 5).**

This appliance must not be installed over any other appliance that generates heat such as a plinth heater.

**Note: Due to many different types of installation, a mains cable is not supplied with this product. The installer will fit the correct type and length of cable.**

## GENERAL

The appliance is designed to be mounted on a floor between two adjacent cabinets.

The cabinets must be securely fixed to the wall and the cooker securely fixed to the cabinets.

This cooker must not be used free standing.

Note; This cooker must not be fitted on a platform.

## FINAL INSTALLATION

- Ensure that the adjacent cabinets and the gap between them have dimensions in accordance with the diagram.
- Assemble the plastic plugs provided into the fixing brackets. See diagram.
- Fix the fixing brackets to the sides of the adjacent cabinets so that the centre line of the brackets are 570mm above the top of the plinth line and the front face of the plastic plug is level with the front face of the cabinet sides. See diagram.
- Adjust the feet on the cooker to their minimum position, i.e. fully screwed in.
- Slide the cooker centrally into the space between the cabinets ensuring the following:
  - The gap between the cabinet sides and the cooker is even along the length of the cabinet sides.
  - The cable is routed away from any vents in the rear panel and is not trapped between the cooker and the wall, adjacent cabinets or under the feet.
- Adjust the feet using an open ended spanner until the bottom of the cooker door is in line with the top of the plinth. Using a spirit level, check that the cooker is level in all directions.
- Check that the plinth can be fitted. If necessary re-adjust the feet and check that the cooker is level. Then lock the feet into position by tightening the lock nut using an open ended spanner.
- Open the top oven door and fix the cooker to the brackets through the holes in the side trims.
- Fix the plinth in position.
- Ensure that there is a minimum gap of 1mm between the cooker side trim and the adjacent cabinet doors or drawer fronts.
- If a hob is to be installed directly above the cooker it must not project downwards more than 20mm below the underside of the work top. Any projection of more than 10mm must not project more than 500mm from the wall.

Fig. 5

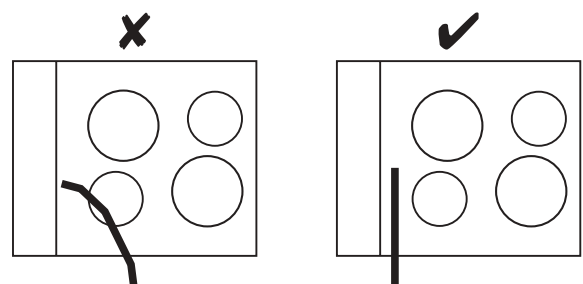



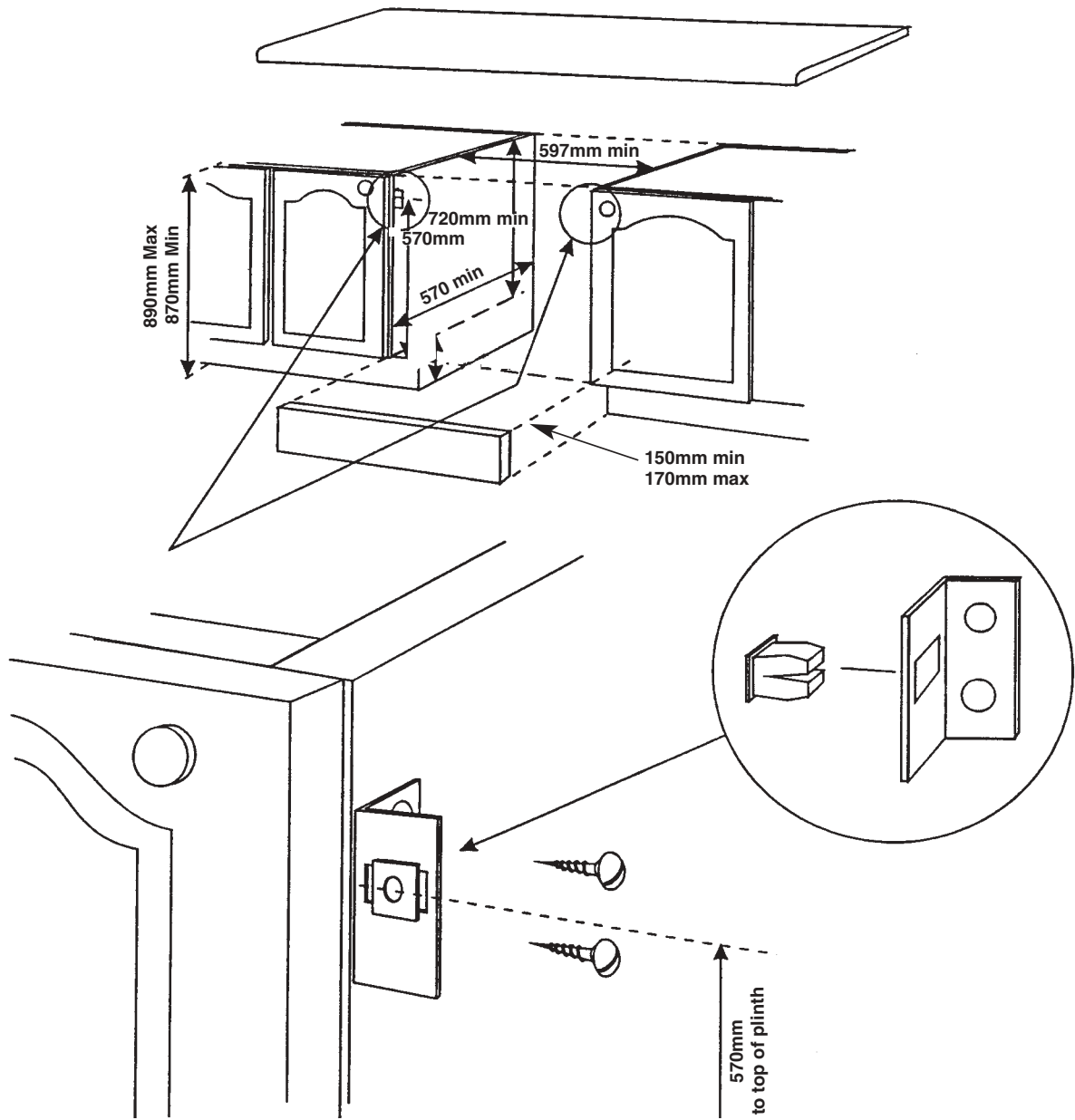

A minimum distance of 25mm should be maintained between the front face of the cabinet side and the front face of the plinth.

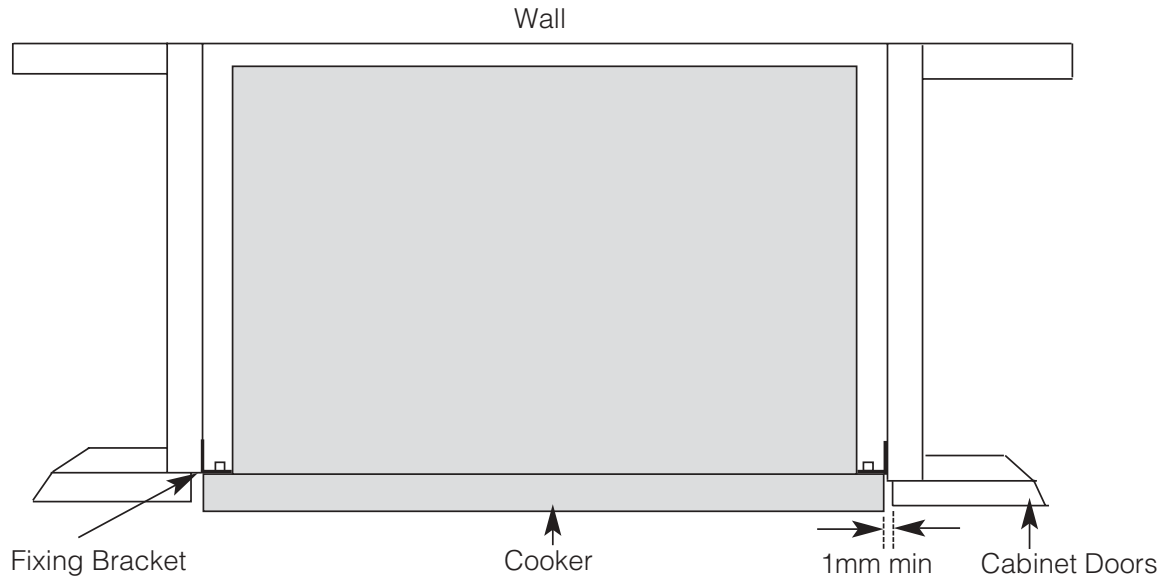

### Top View

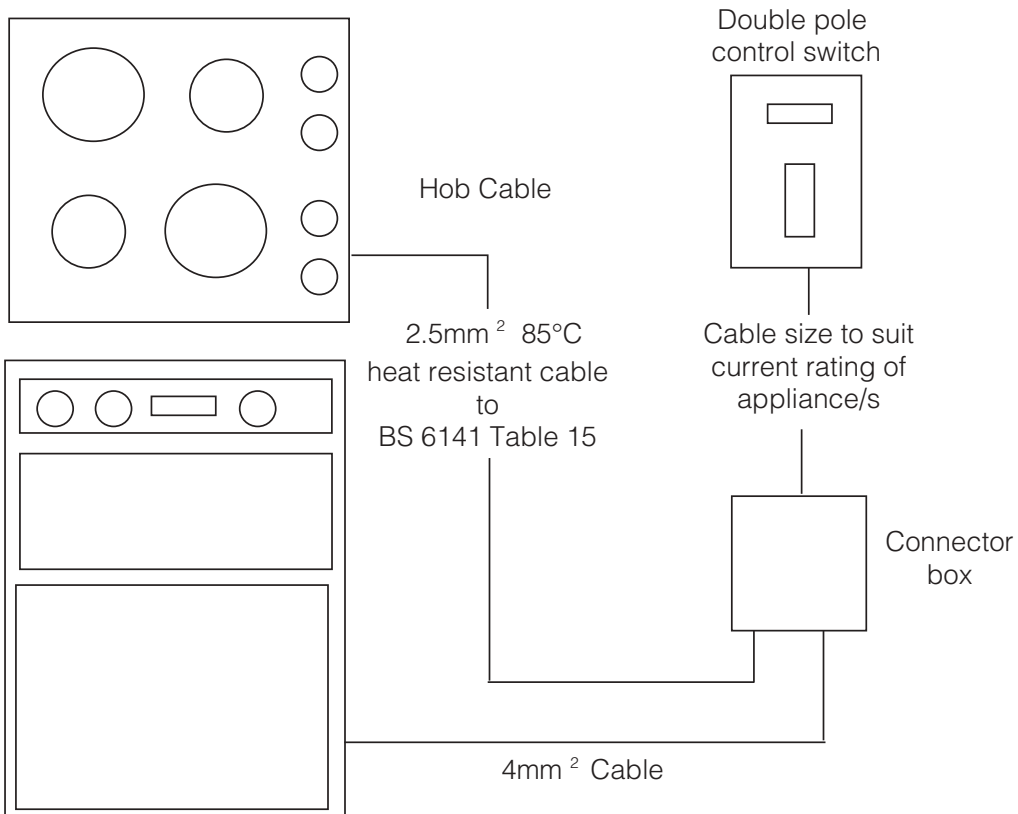

# If something goes wrong...

Before calling a Service Engineer, please check through the following lists.  
THERE MAY BE NOTHING WRONG.

Problem	Check
Slight odour or small amount of smoke when grill / oven used for first time	This is normal and should cease after a short period.
Nothing works	If you find that the timer display is blank, then it is likely that there is no electricity supply to your oven. Check: (i) That the main cooker wall is switched on (ii) Other appliances, to see if you have had a power cut (iii) The main circuit breaker for the property
Top oven, grill and main oven do not work.	Operating the cooker under the following conditions may cause a safety device to operate: (a) Grilling with the door closed - Always grill with the door fully open (b) Grilling for an excessively long period at maximum setting - see Grilling guide. Switch off appliance and allow to cool for approx 30 mins. Switch the cooker back on and check that the Grill / Top oven is now operating.
Grill keeps turning on and off	When the Grill control is operating at less than its maximum setting, the Grill will cycle on and off, this is normal and <u>not</u> a fault.
Timer Display is flashing '0.00' 	The power supply to your oven has possibly been interrupted, but has now come back on again. Reset the timer to the correct day and "Manual" operation using the instructions given in the timer section of the book.
Oven temperatures too high or low	Check temperature and shelf positions are as recommended in the Oven Temperature Charts. It may be necessary to increase or decrease the recommended temperature slightly to suit your taste.
Oven does not cook evenly	Check: (a) Temperature and shelf positions are as recommended in the Oven Temperature Charts. (b) Oven utensils being used allow sufficient air flow around them.

# If something goes wrong...

GB

Problem	Check
Oven light does not work	The oven lamp is not covered by the guarantee. The part is easily changed (see the section on oven lamp replacement). A new lamp may be obtained from our Parts department see back page.
Draught from beneath control panel	A gentle flow of air will be blown from beneath the control panel when the appliance is used. If the appliance is still warm, this cooling fan may run on, or restart itself when all controls have been turned off. The fan will stop once the appliance has been cooled. This is normal and not a fault.
Steam / Condensation in the oven after use.	Steam is a by - product of cooking any food with a high water content. To help minimise always: a) Try to avoid leaving food in the oven to cool after being cooked. b) Use a covered container, wherever possible.

**If you have been through the above list and there is still a problem, contact Service (see back page).**

## Disposal of your product

To minimise the risk of injury to children please dispose of your product carefully and safely. Remove all doors and lids. Remove the mains cable (where fitted) by cutting off flush with the appliance and always ensure that no plug is left in a condition where it could be connected to the electricity supply.

To help the environment, Local Authority instructions should be followed for the disposal of your product.



## Disposal of old electrical appliances

The European Directive 2002/96/EC on Waste Electrical and Electronic Equipment (WEEE), requires that old household electrical appliances must not be disposed of in the normal unsorted municipal waste stream. Old appliances must be collected separately in order to optimise the recovery and recycling of the materials they contain and reduce the impact on human health and the environment.

The crossed out "wheeled bin" symbol on the product reminds you of your obligation, that when you dispose of the appliance it must be separately collected.

Consumers should contact their local authority or retailer for information concerning the correct disposal of their old appliance.



## Guarantee

### 12 months Parts and Labour Guarantee

Your appliance has the benefit of our manufacturer's guarantee, which covers the cost of breakdown repairs for twelve months from the date of purchase.

This gives you the reassurance that if, within that time, your appliance is proven to be defective because of either workmanship or materials, we will, at our discretion, either repair or replace the appliance at no cost to you.

#### The guarantee is subject to the following conditions:

- The appliance has been installed and operated correctly and in accordance with our operating and maintenance instructions.
- The appliance is only used on the electricity or gas supply printed on the rating plate.
- The appliance has been used for normal domestic purposes only.
- The appliance has not been altered, serviced, maintained, dismantled or otherwise interfered with by any person not authorised by us.
- Any repair work must be undertaken by us or our appointed agent.
- Any parts removed during repair work or any appliance that is replaced become our property.
- The appliance is used in the United Kingdom or Republic of Ireland.

#### The guarantee does not cover:

- Damage resulting from transportation, improper use, neglect or interference or as a result of improper installation.
- Replacement of any consumable item or accessory. These include but are not limited to: plugs, cables, batteries, light bulbs, fluorescent tubes and starters, covers and filters.
- Replacement of any removable parts made of glass or plastic.

THE GUARANTEE WILL NOT APPLY IF THE APPLIANCE HAS BEEN USED IN COMMERCIAL OR NON-DOMESTIC PREMISES.

### 5 Year Parts Guarantee

Hotpoint also offers you a FREE 5 year parts guarantee. This additional guarantee is conditional on you registering your appliance with us and the parts being fitted by one of our authorised engineers. There will be a charge for our engineer's time. To activate the extra parts warranty on your appliance, simply call our registration line on **0870 6092094 (ROI 01 230 0800)**

### Extended Guarantees

We offer a selection of protection plans that enable you to fully cover yourself against the expense of repair bills for the life of your policy. To find the ideal plan for you please call our advice line on **08709 088 088 (ROI 01 230 0233)**

### Free Helpdesk Service

We have a dedicated team who can provide free advice and assistance with your appliance if you experience any technical difficulties within the first 90 days of ownership.

Simply call our Hotpoint Service Hotline on **08709 066 066 (ROI 0818 313 413)** for telephone assistance, or, where necessary, to arrange for an engineer to call.



## After Sales Service

No one is better placed to care for your Hotpoint appliance during the course of its working life than us - the manufacturer.

### Essential Contact Information

#### Hotpoint Service

We are the largest service team in the country offering you access to 400 skilled telephone advisors and 1100 fully qualified engineers on call to ensure you receive fast, reliable, local service.

**UK: 08709 066 066**

**Republic of Ireland: 0818 313 413**

**[www.hotpoint.co.uk](http://www.hotpoint.co.uk)**

**Please note: Our advisors will require the following information:**

Model number

Serial number

#### Parts & Accessories

We supply a full range of genuine replacement parts as well as accessory products that protect and hygienically clean your appliance to keep it looking good and functioning efficiently throughout its life.

**UK: 08709 077 077**

**Republic of Ireland: 0818 313 413**

**[www.hotpointservice.co.uk](http://www.hotpointservice.co.uk)**

#### Appliance Registration

We want to give you additional benefits of Hotpoint ownership. To activate your FREE 5 year parts guarantee you must register your appliance with us.

**UK 0870 6092094**

**Republic of Ireland: 01 230 0800**

**[www.hotpointservice.co.uk](http://www.hotpointservice.co.uk)**

As part of Hotpoint's continued commitment to helping the environment, Hotpoint reserves the right to use quality, recycled components to keep down customer costs and minimise material wastage.

GB