

# INSTALLATION & MAINTENANCE MANUAL

## TRICON<sup>®</sup> WATER HEATER

MODELS (40, 50, 75, 90, 100) (L, SS) 125 A-PVIF

MODELS (50, 75, 90, 100) (L, SS) (250, 300) A-PVIF



Installation and service must be performed by a qualified service installer, service agency or the gas supplier.

**IMPORTANT:** THIS MANUAL CONTAINS INFORMATION REQUIRED FOR INSTALLATION, OPERATION AND MAINTENANCE OF THIS EQUIPMENT. READ AND FOLLOW THE INFORMATION IN THIS MANUAL AND ALL OTHER PROVIDED INSTRUCTIONS, LABELS AND MARKINGS BEFORE INSTALLING, OPERATING OR SERVICING THIS UNIT.



**TO THE INSTALLER:** After installation, these instructions must be given to the equipment user or left near the appliance.  
**SPECIAL INSTRUCTIONS TO THE OWNER:** Retain this manual for future reference. These instructions contain important information that will help you in maintaining and operating this appliance.



**PVI**

PVI INDUSTRIES, LLC - Fort Worth, Texas 76111 - Web [www.pvi.com](http://www.pvi.com) - Phone 1-800-433-5654

## TABLE OF CONTENTS

- 1. Safety Considerations**
- 2. Standard Features and Equipment**
  - 2.1 Performance
  - 2.2 Pressure Vessel
  - 2.3 Heat Exchanger
  - 2.4 Code and Standards
  - 2.5 Burner, Operating Controls & Safeties
  - 2.6 Warranty and Service Policy (see warranty and service policy for details)
  - 2.7 Miscellaneous
- 3. Product Descriptions**
- 4. Water Heater Installation**
  - 4.1 Checking Equipment Before You Install
  - 4.2 Codes
  - 4.3 Electrical Requirements
  - 4.4 Handling and Location
  - 4.5 Service Clearances
  - 4.6 Clearances to Combustible Surfaces
- 5. General Piping Guidelines**
  - 5.1 Inlet and Outlet Connections
  - 5.2 Building Return Piping
- 6. Condensate Drain, Trap & Disposal**
  - 6.1 Condensate Neutralization System (optional)
- 7. Gas Supply and Piping**
  - 7.1 Gas Train and controls Certification
  - 7.2 Gas Control Trains
  - 7.3 Inlet Pressure
  - 7.4 Manifold Pressure
  - 7.5 Gas Piping Size
  - 7.6 Appliance Isolation during Gas Supply Piping Pressure Test
  - 7.7 Gas Connection
- 8. Combustion and Ventilation Air**
  - 8.1 Equipment Located in Confined Spaces
  - 8.2 Maximum Allowed Remote Combustion Air Inlet Length
  - 8.3 Remote Combustion Air Cap
  - 8.4 Vertical or Horizontal Remote Air Duct Termination
  - 8.5 Remote Air Consideration for Combined Remote Air Ducting
- 9. Venting**
  - 9.1 Venting The TriCon
  - 9.2 Maximum Category IV Vent Length
  - 9.3 Vertical or Horizontal Vent Termination
  - 9.4 Combining Category IV Vents

- 10. Operating and Safety Controls**
  - 10.1 Temperature and Pressure Relief Valve(s)
  - 10.2 Operating Temperature Control
  - 10.3 High Water Temperature Limit Control
  - 10.4 Cathodic Protection
  - 10.5 Electronic Low Water Cut-off (optional)
- 11. TEMPTRAC Electronic Controller Panel**
  - 11.1 Principal of Operation
  - 11.2 Upper LED Readout
  - 11.3 Lower LED Readout
  - 11.4 Control Buttons
  - 11.5 To View the Setpoint
  - 11.6 To Change the Setpoint
  - 11.7 To Change Other Parameters
  - 11.8 LED Display Alarm Messages
- 12. Remote Connections – Terminal Strip**
  - 12.1 Making BMS/BAS Remote Connection for Analog and Binary Signals
  - 12.3 Terminal Functions
- 13. Sequence of Operation**
- 14. Initial Startup**
  - 14.1 Initial Startup Requirements
  - 14.2 Tools and Instrumentation Required
  - 14.3 Resources
  - 14.4 On Site Considerations
  - 14.5 Startup Procedure
- 15. Troubleshooting Guide**
- 16. Replacement Parts**
  - 16.1 Control Panel
  - 16.2 Control Panel Components
  - 16.3 Burner Assembly
  - 16.4 Burner Assembly Components
- 17. Periodic Maintenance**
- 18. Recommended Maintenance Schedule**

**Warranty forms ship separately with each product.**

# 1 SAFETY CONSIDERATIONS

**WARNING: If the information in the supplied manual(s) is not followed exactly, a fire, explosion or exposure to hazardous materials may result, causing property damage, personal injury or loss of life.**

## FOR YOUR SAFETY

- Do not store or use gasoline or other flammable vapors or liquids in the vicinity of this or any other appliance.

## WHAT TO DO IF YOU SMELL GAS

- Do not try to light any appliance.
- Do not touch any electric switch; do not use any phone in your building.
- Immediately call your gas supplier from a location away from your building and the smell of gas. Follow the gas supplier's instructions.
- If you cannot reach your gas supplier, call the fire department.

Installation and service must be performed by a qualified installer, service agency or the gas supplier.

This product contains, or may come to contain materials that have been identified as carcinogenic, or possibly carcinogenic to humans. Before installing, servicing or removing this product, read and follow the supplied instructions

**WARNING: Installation and service must be performed by a qualified installer, service agency or the gas supplier, who must read and follow the supplied instructions before installing, servicing or removing this appliance. Refer to the information contained in this manual. Improper installation, adjustment, alteration, service or maintenance can cause property damage, personal injury, exposure to hazardous materials or loss of life.**

**WARNING: Do not use this appliance if any part has been under water. Immediately call a qualified service technician to inspect the unit and to replace any part of the control system, all gas controls and all other items affecting safe appliance operation and which has been under water.**

**WARNING: In an emergency shut the main gas supply valve to the appliance from a location safely away from the emergency. Failure to follow these instructions can cause property damage, personal injury, and exposure to hazardous materials or loss of life.**

## PRODUCT SAFETY INFORMATION REFRACTORY CERAMIC FIBER PRODUCT WITH CRYSTALLINE SILICA

**WARNING: This product contains or may come to contain crystalline silica, which has been identified by the International Agency for Research on Cancer (IARC) as carcinogenic to humans. This product also contains refractory ceramic fibers, which have been identified by the IARC as possibly carcinogenic to humans. Avoid breathing fiber particulates and dust.**

### RISKS:

- Air borne fibrous insulation is a possible cancer hazard by inhalation.
- Airborne crystalline silica may cause silicosis (lung disease) by inhalation.
- May cause temporary irritation to eyes, skin, and respiratory tract.

### PRECAUTIONARY MEASURES:

- Minimize airborne fibers with engineering controls.
- Use NIOSH/MSHA approved respirators as required (see MSDS).
- Wear long sleeved, loose-fitting clothing, eye protection and gloves.

### FIRST AID MEASURES: (If any of the irritations listed persists, seek medical attention)

- Eyes: Flush with water.
- Skin: Wash with soap and warm water.
- Ingestion: Do not induce vomiting. Get medical attention if gastrointestinal symptoms develop.
- Inhalation: Remove to fresh clean air.

**WARNING: If you are unfamiliar with the safe handling of refractory ceramic fiber products, or if you wish additional information prior to beginning any disassembly of the water heater or boiler that might expose refractory ceramic fiber materials, contact: Unifrax Corporation, 2351 Whirlpool Street, Niagara Falls, NY 14305-2413, 1-800-322-2293.**

### IDENTIFICATION OF REFRACTORY CERAMIC FIBER MATERIALS (RCF):

The burner, lower tank and upper and lower flue collector assemblies utilize RCF material. (The RCF materials are located within the product and not generally exposed except during service, disassembly or assembly.)

**IMPORTANT SAFETY NOTE**

*It takes only 5 seconds of skin contact with 140°F water to cause a second degree burn! You must protect against high water temperatures at all lavatories, tubs, showers and other points of hot water contact.*

**Accidental scalding from high water temperatures is a greater risk in some types of installations. Some examples are:**

**HOMES FOR THE MENTALLY HANDICAPPED  
HOMES FOR THE PHYSICALLY HANDICAPPED  
HOSPITALS AND NURSING HOMES  
ELDER CARE FACILITIES AND REST HOMES  
ORPHANAGES AND CHILD CARE FACILITIES**

**OTHER INSTALLATIONS - WHERE RESPONSE TO CONTACT WITH HOT WATER MAY BE SLOWER OR WHERE THE DANGER OF HOT WATER CONTACT IS GREATER**

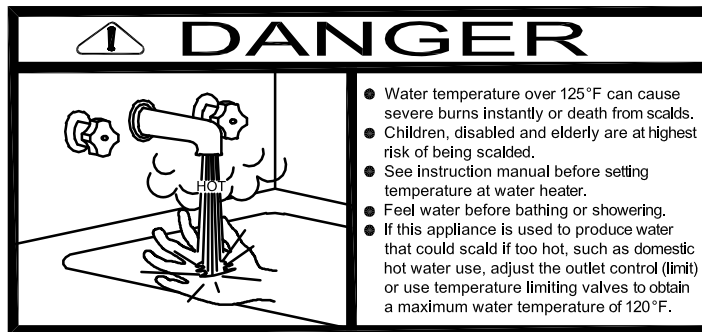

**Thermostatically controlled mixing valves must be used in the design of the potable hot water system.**

**Potable hot water should be tempered to no more than 110°F when used for bathing or other personal uses.**

**Good engineering practice mandates the use of thermostatically controlled mixing valves set at 120°F or less to keep the delivered water temperature below scalding temperatures.**

## 2 STANDARD FEATURES AND EQUIPMENT

### 2.1 Performance

- 90% thermal efficiency at full fire from 40° to 140°F
- Up to 96% thermal efficiency with modulation
- < 20 ppm NOx (399 to 900 MBH)
- Ducts direct combustion air up to 100 equivalent feet through 6-inch diameter material (requires UL approved vent cap, see optional equipment list)
- Vents up to 100 equivalent feet through 6-inch diameter material

### 2.2 Pressure Vessel

- AquaPLEX® tank (unlined duplex alloy)
- Storage tank ASME stamped and National Board registered for 150 psi MAWP
- Nonferrous, removable fittings at all tank connections
- Hand hole cleanout
- Fiberglass insulation
- Steel jacket panels with industrial-grade finish
- Drain valve

### 2.3 Heat Exchanger

- Three-pass, fire tube design
- AquaPLEX® fire tubes

### 2.4 Codes and Standards

- Intertek / ETL listed to US and Canadian safety standards
- Intertek / ETL listed for use with stainless steel Category IV vent material
- Intertek / ETL certified as low-lead compliant
- FM compliant
- ASHRAE 90.1 compliant

### 2.5 Burner, Operating Controls & Safeties

- Pre-mix surface burner with self-adjusting, proportionate gas/air ratio
- UL 795 compliant gas train
- Electronic flame safeguard with pre- and post-purge
- Combustion sequence panel lights including lockout
- Programmable electronic operating control with digital temperature readouts, adjustable from 70°F to 180°F
- Immersion temperature limiting device (high limit control)
- ASME-rated temperature and pressure relief valve
- NEMA-1 control enclosure
- Terminals for remote on-off
- Flame failure audible alarm and indicating light with remote contacts
- Seamless VFD modulation with 7-to-1 turndown

### 2.6 Warranty and Service Policy (see warranty or service policy for details)

- 10-Year tank warranty (PV 627)
- 3-Year scale failure warranty (PV 563)
- First-year cost-free service policy (PV 551)
- 10-Year chloride-induced stress corrosion cracking warranty (PV 8083)

### 2.7 Miscellaneous

- Factory authorized startup
- Vent termination cap, 6-inch diameter (larger cap optional)
- Factory-equipped for connection to direct inlet air (requires UL listed vent termination cap, see options list)
- Condensate “P” trap (provided for field installation)

**3 PRODUCT DESCRIPTION Component, Controls and Connection Locations  
(Locations May Vary)**

**125 SERIES**

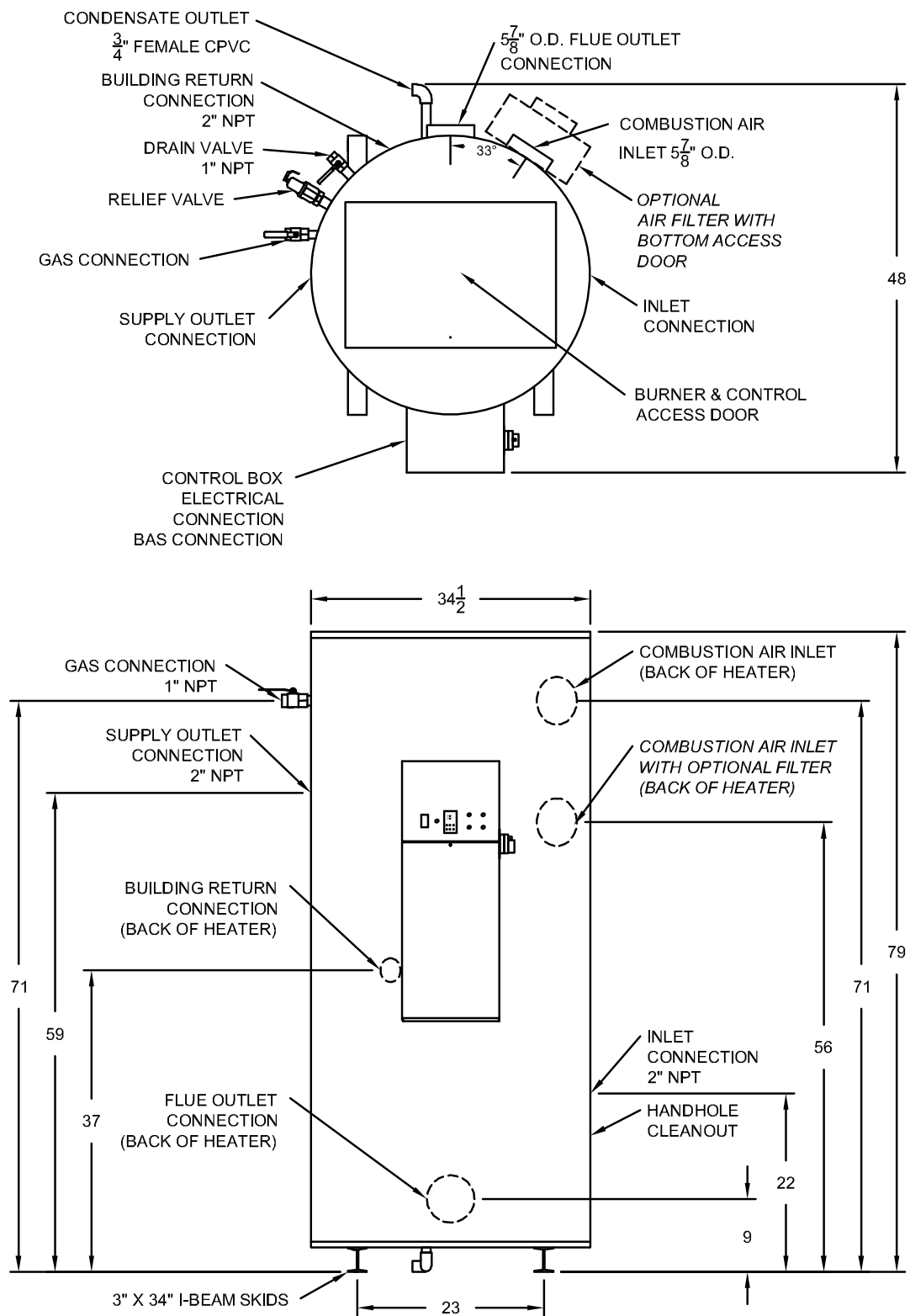

## 250 SERIES

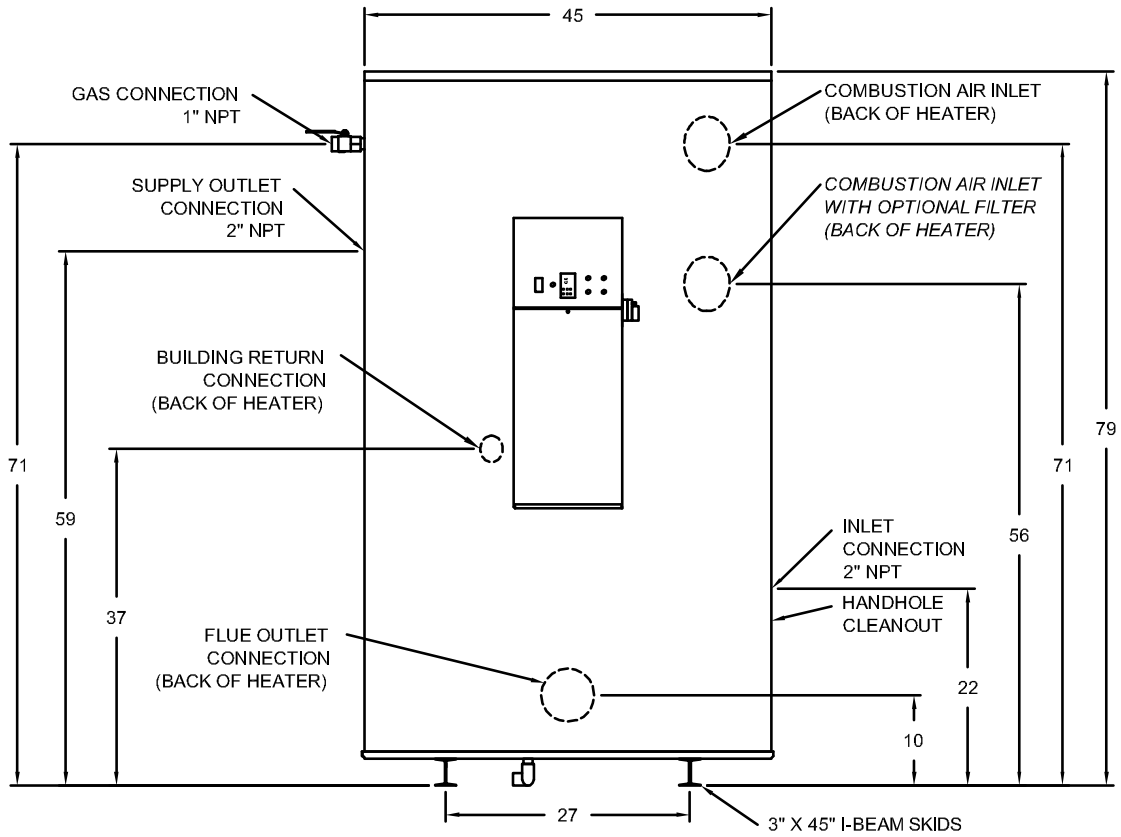
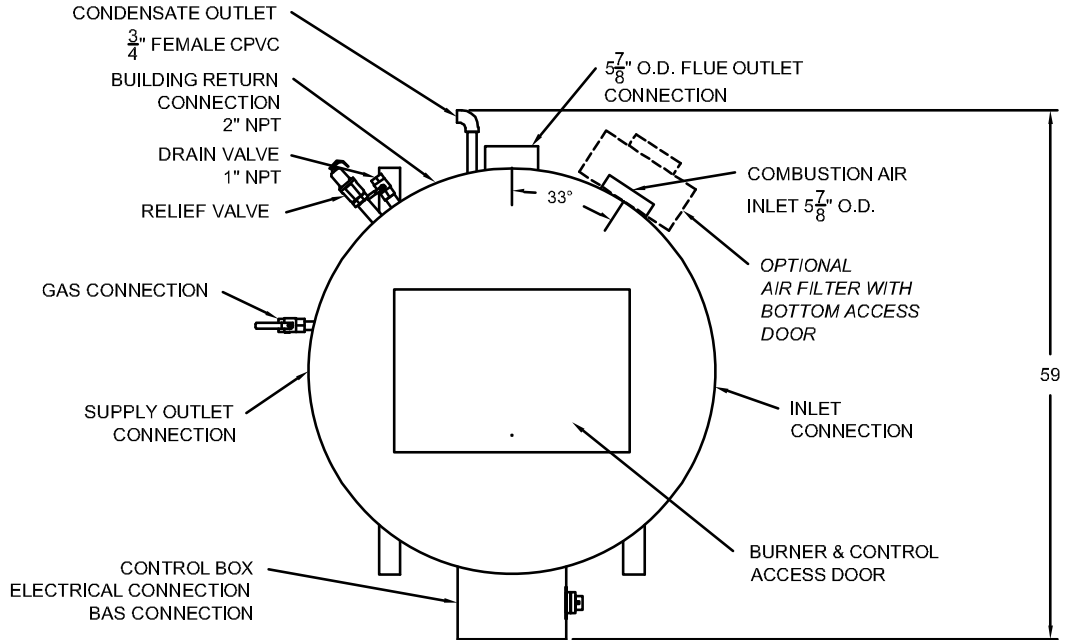



### 300 SERIES

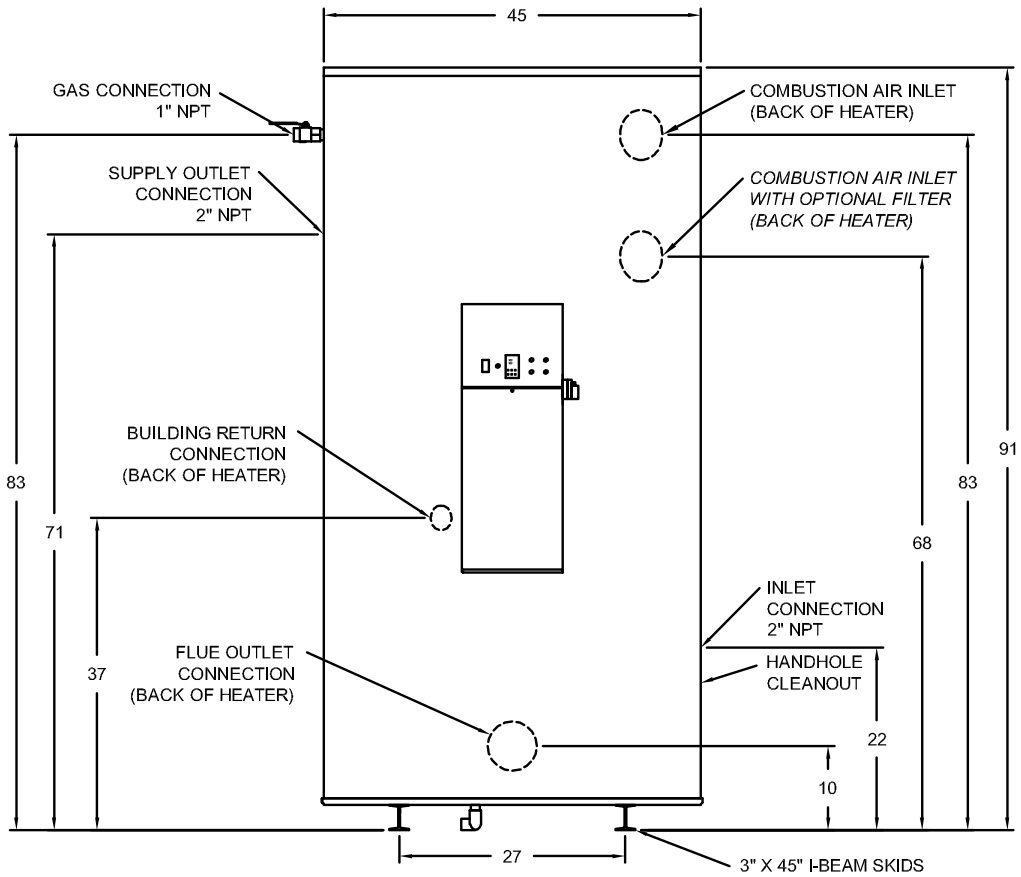
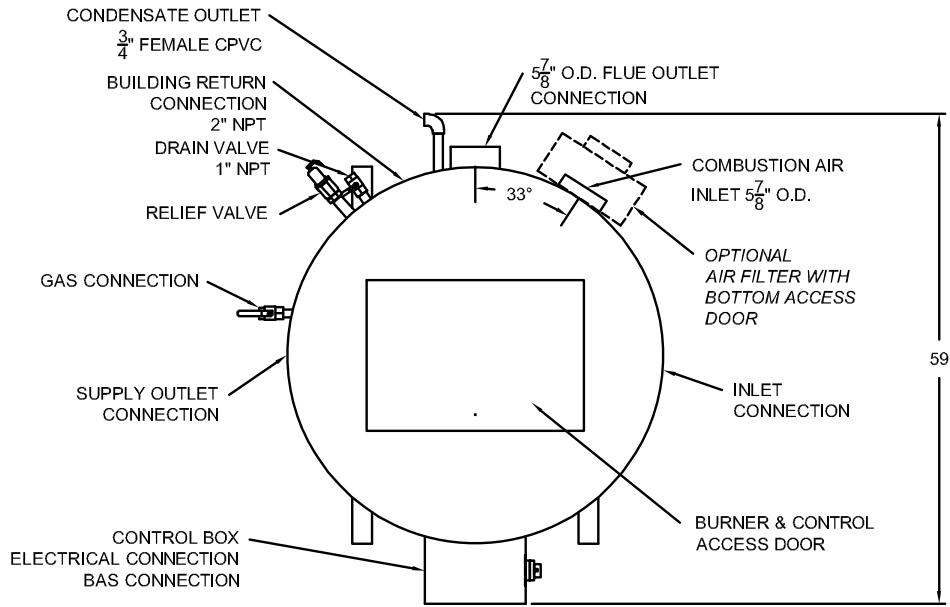

## 4 WATER HEATER INSTALLATION

### 4.1 Checking Equipment Before You Install

Inspect the unit completely upon receipt from the freight carrier before signing the bill of lading. Inspect the appliance and all accompanying parts for signs of impact or mishandling. Verify the total number of pieces shown on packing slips with those actually received. Contact the freight carrier immediately if any damage or shortage is detected.

### 4.2 Codes

The equipment must be installed in accordance with those installation regulations in force in the local area where the installation is to be made. Authorities having jurisdiction must be consulted before installation is made. In the absence of such requirements, the installation shall be in accordance with the instructions in this manual, appliance markings and supplemental instructions and in compliance with the latest edition of the National Fuel Gas Code, ANSI Z223.1. Where required by the Canadian authority having jurisdiction, the equipment must be installed in accordance with the latest edition of the Installation Code for Gas Burner Appliances and Equipment CAN/CSA B149.1 and/or B149.2 and applicable Provincial Regulations. All appliances conform to the latest edition of the ASME Boiler and Pressure Vessel Code, Section IV, Part HLW.

### 4.3 Electrical Requirements

See appliance rating decal for electrical service requirements. The appliance must be electrically supplied and grounded in accordance with the requirements of the authority having jurisdiction or in the absence of such requirements, with the latest edition of the National Electrical Code ANSI/NFPA No. 70. In Canada, the electrical service must conform to local electrical codes and/or CSA C22.1, Canadian Electrical Code, Part 1.

- All wiring between the unit and field installed devices must be made with type T copper wire.
- Line voltage wire exterior to the appliance must be enclosed in approved conduit or approved metal clad cable.
- To avoid serious damage, **DO NOT** energize the unit until the system and appliance is full of water.

### 4.4 Handling and Location

**WARNING: Use industry standard safe rigging methods, such as including the use straps and spreader bars and lifting from the water heater base skid assembly, when attempting to lift or move this product. Failure to follow industry safe rigging methods could result in property damage, serious injury or death.**

- 1 Check the data decal on the appliance. Be sure the electrical, water, oil, or gas supply is adequate for the installation.
- 2 Carefully remove all shipping supports and bracing.
- 3 These units are suitable for indoor installation only.
4. Installing the water heater on a 4 inch to 6 inch housekeeping pad is recommended to ensure proper condensate drainage.
5. Locate the unit so that if water connections should leak, water damage will not occur. When such locations are unavoidable, install a suitable drain pan, and plumb pan to ensure adequate drainage in the event of a leak. Under no circumstances is the manufacturer responsible for water damage in connection with this unit, or any of its components. The manufacturer's warranty does not cover water damage.
6. Protect associated electrical components and electrical connections from water (dripping, spraying, rain, etc.) during appliance operation and service.
7. Place the appliance on a level, non-combustible floor. Concrete over wood is not considered non-combustible.

8. Do not install on carpet or other combustible floor coverings. If installation over a combustible floor is required, follow these guidelines:
- Use a base of hollow clay tile or concrete blocks from 8" to 12" thick and extending 24" beyond the sides.
  - Place the blocks in line so that the holes line up horizontally to provide a clear passage through the blocks.
  - Install 1/2" fireproof millboard with a 20-gage sheet metal cover over the block base.
  - Center the unit on the base. Also follow this procedure if electrical conduit runs through the floor, and beneath the appliance. A field-installed base must meet all local fire and safety code requirements.

#### **4.5 Service Clearances**

Allow sufficient space to provide adequate clearances on all sides for service and inspection. At least 24" above the water heater is required for filter replacement (if equipped) and burner/gas control service, 18" at left and right sides of the appliance. Optional equipment may increase the clearance requirements. Allow sufficient space for installing and servicing connections such as water, gas, vent, combustion air, electrical, pump and other auxiliary equipment.

#### **4.6 Clearances To Combustible Surfaces**

Minimum 1" clearance must be provided from any vent surface to adjacent combustible material. The minimum clearances to unprotected combustible material are 24" be provided at the front, 8" be provided at the rear and 8" at top, left and right sides of the appliance.

### **5 GENERAL PIPING GUIDELINES**

#### **5.1 Inlet and Outlet Connections**

1. Use only non-ferrous water piping and fittings. Do not use galvanized pipe or fittings. Use of ferrous or galvanized pipe or fittings can cause rust to form.
2. Install shut-off valves and unions on the inlet and outlet water piping for servicing. Use caution when threading pipe nipples into tank connections to prevent cross threading, or over-tightening. Always use a back-up wrench on tank nipples when tightening unions, valves, etc.
3. Insulate hot water and return circulation lines. Insulate cold water supply lines if subject to freezing during shutdown periods. **IMPORTANT:** Do not use the plumbing connected to the appliance as a ground for welding or any other purpose.
4. Pipe the drain valve to a suitable open drain.

#### **5.2 Building Return Piping**

To maximize water heater efficiency, connect the building return ( $\approx 5$  gpm) directly to the return fitting located at the rear of the tank.

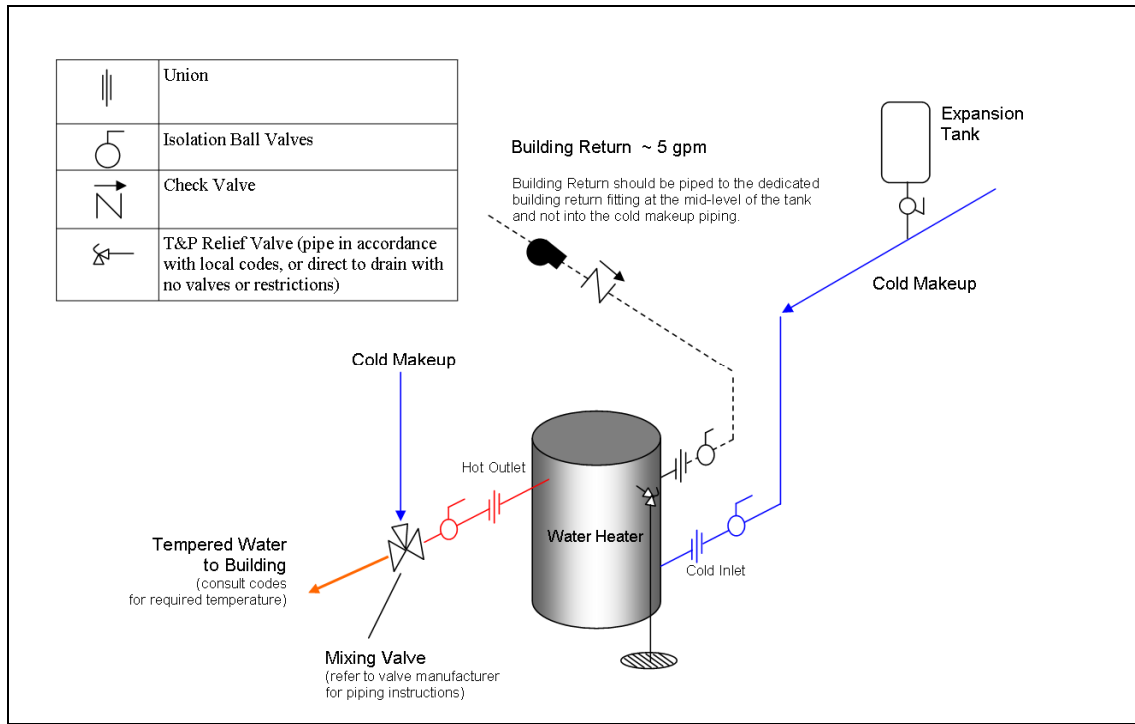

**SINGLE WATER PIPING**

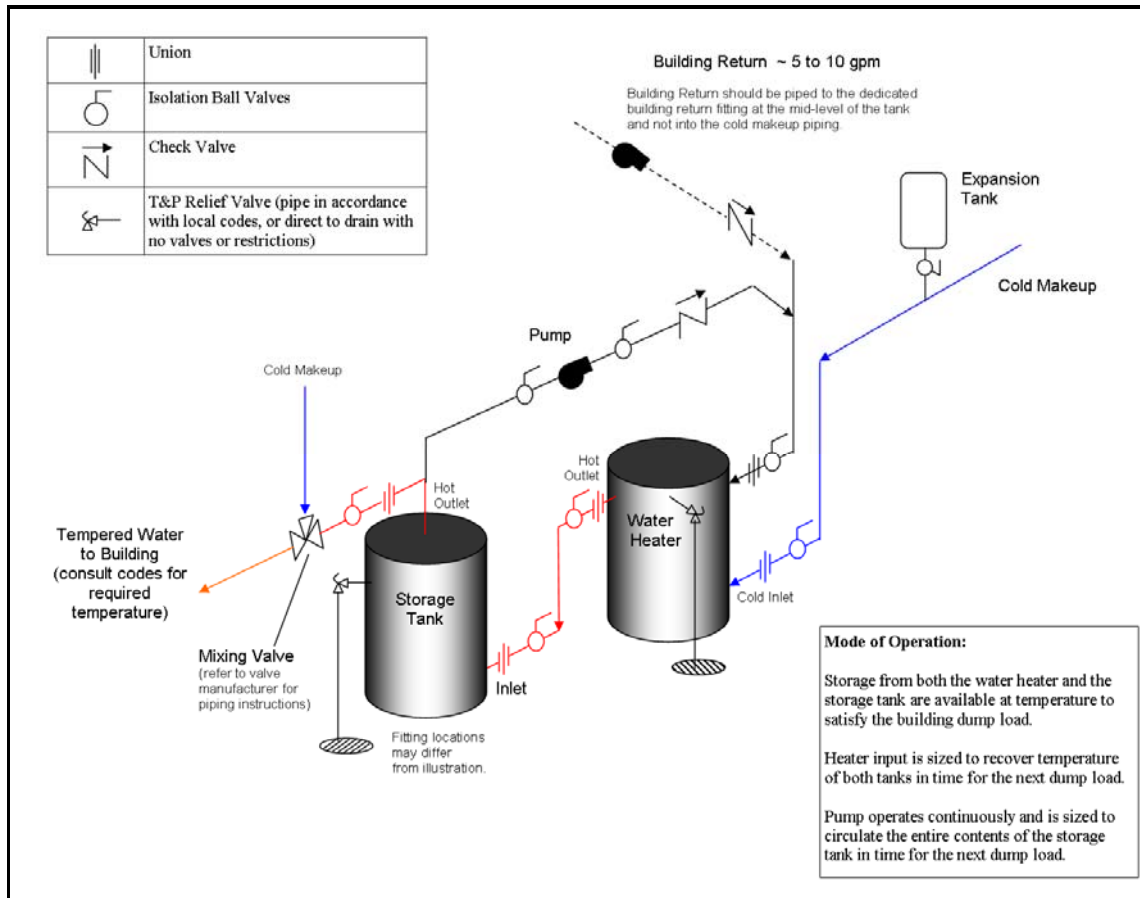

**SINGLE STORAGE WATER HEATER WITH SUPPLEMENTAL STORAGE TANK**

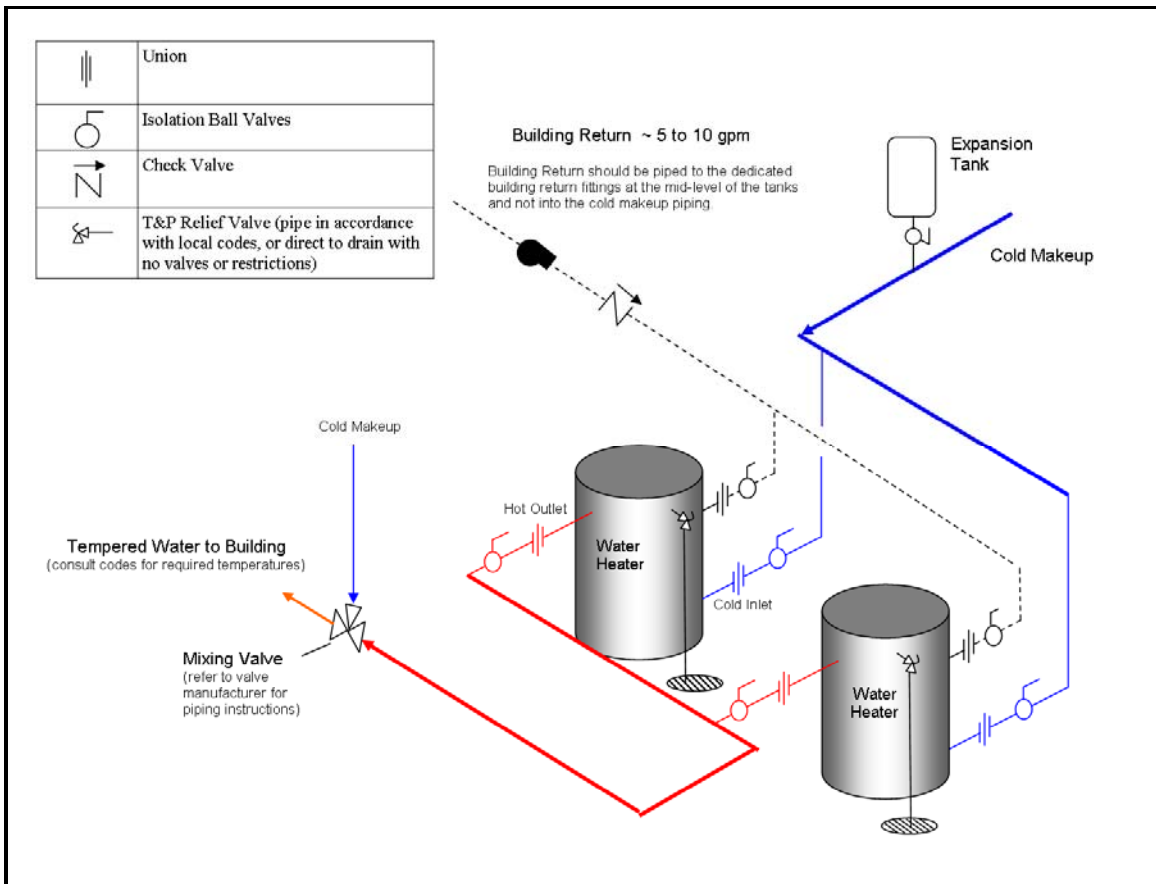

**TWO WATER HEATERS WITH REVERSE RETURN PIPING**

## 6 CONDENSATE DRAIN, TRAP & DISPOSAL

The Tricon water heater is designed to produce significant amounts of condensate because of its high efficiency. Condensate occurs naturally when water vapor in combustion gases is cooled below the dew point. A 3/4" NPT drain connections is provided. A trap with three inches of standing water below the bottom of the heater (3" above the base of the I-Beam skids), and no higher than the bottom of the heater must be field installed as part of the condensate piping.

**WARNING: A trap with three inches of standing water as described in these instructions must be included as part of the condensate piping system. This trap is required to keep hazardous products of combustion from continually entering the room through the condensate piping. Failure to provide this trap can cause, personal injury, exposure to hazardous materials or loss of life.**

1. Installing the water heater on a 4 inch to 6 inch housekeeping pad is recommended to ensure proper condensate drainage.
2. Attach a 3/4" CPVC pipe from the heater condensate to a 3" CPVC trap and on to a suitable floor drain or collection system. Each condensing appliance must drain separately. Do not combine condensate drains from multiple condensing appliances into a single drain pipe.
3. Each condensate drain must contain a trap or siphon/pigtail to provide at least 3 inches of standing water, to prevent flue gas flow through the condensate piping. To construct the trap, connect to the 3/4" condensate drain, route the piping downward until the standing water in the trap is not higher than the bottom of the water heater.
4. Install the condensate plumbing as shown in the following diagram.
5. All condensate plumbing must be protected from freezing. Do not locate the condensate piping such that an ice dam of frozen condensate can block the outlet.

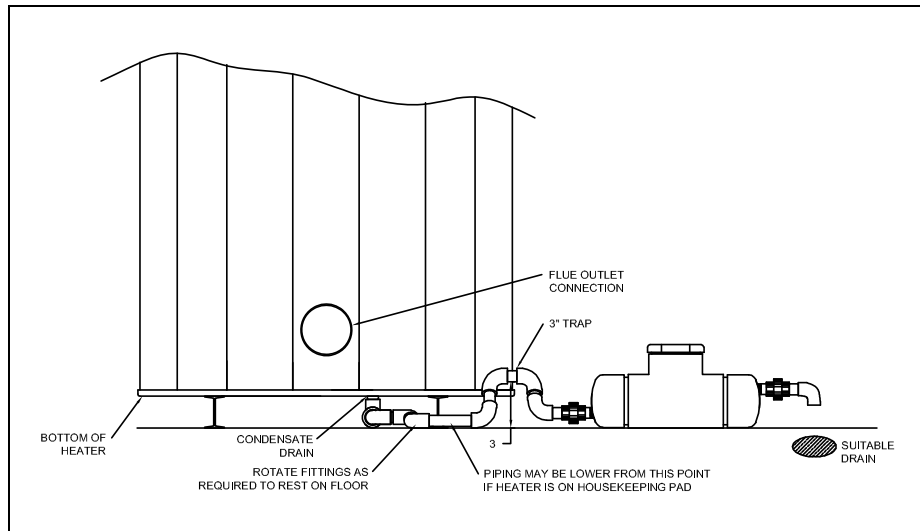

**Condensate Piping and Trap with Optional Condensate Neutralizer**

### 6.1 Condensate Neutralization System (optional)

Although only slightly acidic (3-5 PH), condensate can be routed through an optional Condensate Neutralization System (see image below) to become pH neutral allowing for disposal into any drain or sewer system without concern for corrosion. Condensate slowly flows through a neutralization bath filled with renewable crushed limestone becoming neutralized thus avoiding chemical treatment or dilution using substantial quantities of tap water. To obtain a Condensate Neutralization System, please contact your local PVI representative.

1. Follow the steps 1 through 4 in the Condensate Drain, Trap & Disposal section above.
2. Locate the Condensate Neutralization System in the condensate piping, as shown in the FIELD INSTALLED CONDENSATE DIAGRAM above.
3. Position with removable crushed limestone fill-cap in vertical position only. The bottom of the condensate neutralization system outlet pipe must not be higher than the bottom of the water heater.
4. For proper operation, the water heater condensate outlet must be plumbed with CPVC plastic pipe to the lowest fitting of the Condensate Neutralization System, connecting to the "INLET" as shown in the graphic below.
5. Keep the Condensate Neutralization System closed at all times, except for maintenance.

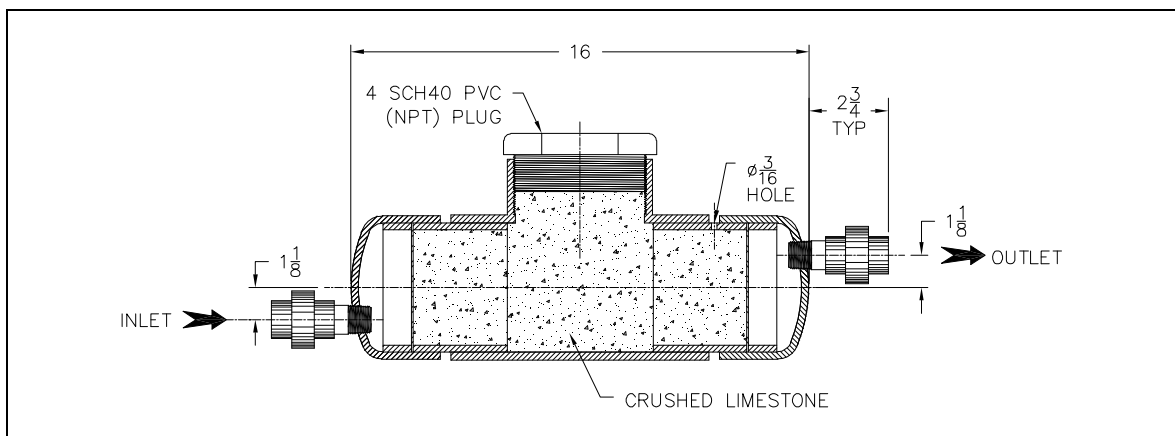

**Optional Condensate Neutralization System**

**WARNING: Keep the Condensate Neutralization System closed at all times the appliance is operating. The system must remain closed to prevent hazardous products combustion from continually enter the room. Failure to keep the Condensate Neutralization System closed can cause property damage, personal injury, exposure to hazardous materials or loss of life.**

## 7 GAS SUPPLY AND PIPING

Verify that the type of gas specified on rating plate is supplied to the unit. This unit is orificed for operation up to 2000 feet altitude. Appliance Btuh output derates 4% per 1000 feet elevation above sea level. Consult Factory for installations above 2000 feet elevation.

### 7.1 Gas Train and Controls Certification

**NOTE:** The gas train and controls assembly provided on this unit have been tested under the applicable American National Standard to comply with safety and performance criteria such as proper ignition, combustion and safety shutdown operation.

### 7.2 Gas Control Trains

All models include gas control trains with the following components: main manual shutoff valve, two safety shutoff valves, proportionator regulator and a final manual valve with the manifold pressure tap on the side of the valve. These components may be separate or two or more may be combined in a common housing.

**CAUTION:** Do not adjust or remove any screws or bolts on gas train control components which are sealed with a red or blue colored compound. Doing so will void all approvals and warranties.

### 7.3 Inlet Pressure

Measure at the inlet pressure tap located at the main gas cock. The inlet pressure must remain within the minimum and maximum values while the unit is at rest and while the unit is operating at maximum firing rate.

INLET PRESSURE	NAT. GAS	LP
Maximum Static Pressure (Inches-Water Column)	14"	14"
Minimum Flow Pressure (Inches-Water Column)	4.5"	11"

### 7.4 Manifold Pressure

Measure at the pressure tap located downstream side of the manual valve closest to the burner. The rated manifold pressure appears on the product data label located near the front of the appliance.

### 7.5 Gas Piping Size

Use the values in "Convert Fittings To Equivalent Straight Pipe" to add the equivalent straight pipe for each elbow or tee to obtain the total distance from the meter.

CONVERT FITTINGS TO EQUIVALENT STRAIGHT PIPE								
Diameter Fitting (inches)	¾"	1"	1¼"	1½"	2"	3"	4"	5"
Equivalent Length of Straight Pipe (feet)	2'	2'	3'	4'	5'	10'	14'	20'

Use this corrected total distance from the meter for determining the suggested pipe size in the "Single Unit Installation Suggested Gas Pipe Size" table.

Equivalent Feet From Meter	SINGLE UNIT INSTALLATION SUGGESTED PIPE SIZE Maximum Capacity for Natural Gas* MBTU/HR Based on 0.5" W.C. Pressure Drop**					
	1-1/4"	1-1/2"	2"	2½"	3"	4"
25	860	1320	2475	3900	7000	-
40	660	990	1900	3000	5300	-
60	-	810	1520	2400	4300	-
80	-	690	1300	2050	3700	-
100	-	620	1150	1850	3250	6700
125	-	-	1020	1650	2950	6000
150	-	-	950	1500	2650	5500
175	-	-	850	1370	2450	5000
200	-	-	800	1280	2280	4600

\*Multiplier for Propane: 1.57

\*\*Multiplier for alternate pressure drops: 0.3" W.C. 0.77; 1.0" W.C. 1.41; 2.0" W.C. 2.00; and 4.0" W.C. 2.82.

MULTIPLE UNIT INSTALLATIONS GAS PIPING SIZE CHART Maximum Capacity of Pipe in Thousands of BTU's per hour for gas pressures of 14 Inches Water Column (0.5 PSIG) or less and a pressure drop of 0.05 Inch Water Column (Based on NAT GAS, 1025BTU's per Cubic Foot of Gas and 0.60 Specific Gravity).														
Nominal Iron Pipe Size, Inches	Length of Pipe in Straight Feet													
	10	20	30	40	50	60	70	80	90	100	125	150	175	200
3/4	369	256	205	174	155	141	128	121	113	106	95	86	79	74
1	697	477	384	328	292	267	246	256	210	200	179	164	49	138
1 1/4	1400	974	789	677	595	543	502	472	441	410	369	333	308	287
1 1/2	2150	1500	1210	1020	923	830	769	707	666	636	564	513	472	441
2	4100	2820	2260	1950	1720	1560	1440	1330	1250	1180	1100	974	871	820
2 1/2	6460	4460	3610	3100	2720	2460	2310	2100	2000	1900	1700	1540	1400	1300
3	11200	7900	6400	5400	4870	4410	4000	3800	3540	3300	3000	2720	2500	2340
4	23500	16100	13100	11100	10000	9000	8300	7690	7380	6870	6150	5640	5130	4720

## 7.6 Appliance Isolation during Gas Supply Piping Pressure Test

1. The appliance and its provided manual shutoff valve must be disconnected from the gas supply piping system during any pressure testing of that system at test pressures in excess of ½ PSI (3.5 kPa).
2. The appliance must be isolated from the gas supply piping system by closing its individual manual shutoff valve during any pressure testing of the gas supply piping system at test pressures equal to or less than ½ PSI (3.5 kPa).
3. The appliance and its gas connection must be leak-tested before placing it in operation.



## 7.7 Gas Connection

1. Safe operation of unit requires adequate gas supply with the required static and dynamic (flow) pressures. Actual piping selection depends on many variables that must be carefully considered by the gas piping system designer.  
Do not select gas pipe sizes based only on the supplied tables. These tables are for use by the gas piping system designer as a reference in checking pipe size selections.
2. Gas pipe size may be larger than heater connection.
3. Installation of a union is suggested for ease of service.
4. Install a manual main gas shutoff valve, outside of the appliance gas connection and before the appliance provided appliance manual shutoff gas valve, when Codes require.
5. The gas system installer should clearly identify the emergency shut-off device.
6. A sediment trap (drip leg) MUST be provided in the inlet of the gas connection to the unit.
7. The code compliant vent limiters are designed and must respond to pressure changes in the installation environment, as opposed to outdoor pressure. For proper operation, do not connect to outdoor atmosphere.

## 8 COMBUSTION AND VENTILATION AIR

Provisions for adequate combustion and ventilation air to the mechanical room must be in accordance with Section 5.3 "Air for Combustion and Ventilation" of the latest edition of the National Fuel Gas Code, ANSI Z223.1 and/or CAN/CSA B149, Installation Codes or applicable provisions of the local building codes.

### 8.1 Equipment Located In Confined Spaces

Equipment located in confined spaces requires two openings installed within 12" (30.5 cm) from the top and bottom of the room to assure adequate combustion air and proper ventilation. The total input of all gas utilization equipment installed in the room must be used to determine the required minimum air volume needed for combustion, ventilation and dilution of flue gasses.

- **All Air From Outdoors:**

Each opening requires a minimum free area of 1 square inch per 4000 Btu/hr input if directly communicating with the outdoors or communicating to the outdoors through vertical ducts.

Each opening requires a minimum free area of 1 square inch per 2000 Btu/hr input if communicating with the outdoors through horizontal ducts.

- **All Air From Inside The Building:**

Each opening requires a minimum free area of 1 square inch per 1000 Btu/hr input, but not less than 100 square inches (0.06 m<sup>2</sup>).

- **Combination Of Air From The Indoors And From The Outdoors:**

Refer to National Fuel Gas Code, ANSI Z223.1 and/or CAN/CSA B149, Installation Codes or applicable provisions of the local building codes.

**NOTE:** This unit may be installed with a remote air intake system which uses a make-up air duct to draw combustion air directly from outdoors.

**WARNING:** Adequate clean combustion air must be provided to the appliance. Under no circumstances should the appliance ever be under a negative pressure. Particular care should be taken when exhaust fans, compressors, air handling units, etc. may rob air from the appliance. The combustion air supply must be completely free of any chemical or fumes, which may be corrosive to the appliance. Some common chemical fumes to avoid are fluorocarbons and other halogenated compounds, most commonly present as refrigerants or solvents, such as Freon, trichloroethylene, perchlorethylene, chlorine, etc. These chemicals, when in contact with the equipment or when burned, form acids which quickly attack the tubes, flue collector, stack and other appliance and auxiliary equipment. The result of inadequate clean combustion air or negative pressure can be premature unwarranted product failure or unsafe operation producing carbon monoxide that could escape into the building. Exposure to carbon monoxide can lead to injury or death.

## 8.2 Maximum Allowed Remote Combustion Air Inlet Length (Equivalent Length)

A vertical or horizontal remote air inlet system can be connected to this appliance without modification. The maximum length of field supplied single wall pipe, such as galvanized ventilation pipe, is shown in the chart below titled Maximum Air Inlet Duct Equivalent Length. Use metal tape or RTV sealant to seal each pipe joint.

Maximum Air Inlet Duct Equivalent Length				
Duct Size	6" Duct	7" Duct	8" Duct	9" Duct
<b>Max Equivalent Length</b>	100 feet	130 feet	250 feet	450 feet

To determine the maximum straight length of duct allowed, use the Duct Fitting Equivalent Length chart below to find the total equivalent length for all duct fittings in your combustion air system. Then subtract this number of feet from the total equivalent length allowed in Maximum Air Inlet Duct Equivalent Length chart above. The sum of this calculation is the maximum length of straight duct allowed. If a longer length is required, repeat the calculation using a larger duct size. No additional deduction is required for the addition of the duct system terminal.

Duct Fitting Equivalent Length				
Duct Pipe:	6" Duct	7" Duct	8" Duct	9" Duct
90° Elbow	8 feet	9 feet	10 feet	11 feet
90° Long Radius Elbow	5 feet	5 feet	5 feet	6 feet
45° Elbow	5 feet	5 feet	5 feet	5 feet

The following remote air duct information is provided for use in design calculations, if needed.

Remote Air Duct Specifications	
Input MBtu	Required Air (SCFM)
<b>399</b>	<b>87</b>
<b>500</b>	<b>108</b>
<b>750</b>	<b>163</b>
<b>900</b>	<b>195</b>
<b>1000</b>	<b>217</b>

## 8.3 Remote Combustion Air Cap

A UL Listed air intake vent termination cap **MUST** be attached to the remote combustion air vent termination to adequately protect the combustion air inlet from wind and weather. A UL Listed air intake termination cap is available from PVI Industries and may have shipped with the water heater as a purchased option.

## 8.4 Vertical or Horizontal Remote Air Duct Termination

- Air inlet and exhaust vents should terminate in the same wind pressure area whenever possible.
- Air inlet must be located no less than 3 feet (0.91m) below the exhaust terminal if they are within 10 feet (3.05 m) of each other.
- If terminating through the roof, the air inlet must terminate at least 12 inches (0.3 m) above roof level and at least 12 inches (0.3 m) above snow levels.
- If terminating through a sidewall, the air inlet must terminate at least 12 inches (0.3 m) above grade and/or at least 12 inches (0.3 m) above normal snow levels.

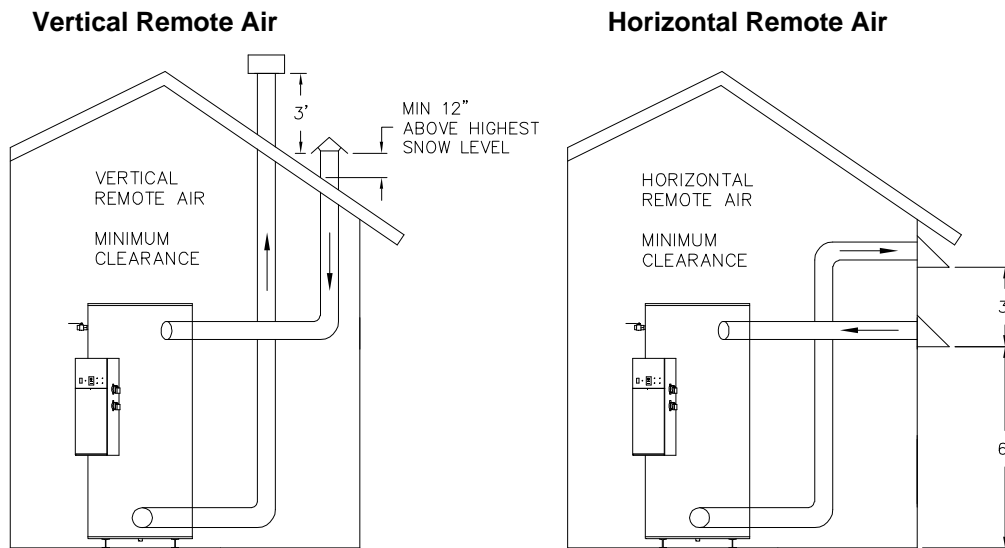

### 8.5 Remote Air Consideration for Combined Remote Air Ducting

Each water heater **MUST** have separate intake piping. Consult factory for common air intake pipe sizing.

## 9 VENTING

### 9.1 Venting the TRICON:

TRICON models are designed for operation only with stainless steel venting listed by UL, ULC, ETL or CSA for Category IV, positive pressure, gas appliance venting. Follow the vent manufacturer's instructions for installation, sealing, supporting and terminating their vent system. Do not use plastic venting of any type. Do not use a barometric damper with the TRICON positive pressure vent.

**WARNING: Use only stainless steel venting listed by a nationally recognized testing laboratory for Category IV, positive pressure, gas appliance venting. Use of plastic pipe of any type or use of venting materials other than specified in these instructions can result in failure of the venting system and/or exposure to carbon monoxide which can result in property damage, personal injury or death.**

**WARNING: Do not vent this water heater into an existing or traditional gas vent or chimney or combine the vent with any other appliance. Such venting could result in failure of the venting system and/or exposure to carbon monoxide which can result in property damage, personal injury or death.**

### 9.2 Maximum Category IV Vent Length (Equivalent Length)

A vertical or horizontal remote Category IV vent system must be used with this appliance. The maximum length of field supplied Category IV vent is shown in the chart below titled Category IV Vent Equivalent Length.

Maximum Category IV Vent Equivalent Length				
Vent Size	6" Vent	7" Vent	8" Vent	9" Vent
Max Equivalent Length	100 feet	130 feet	250 feet	450 feet

Pipe fittings reduce the maximum allowable vent length. Use the Category IV vent manufacturer's equivalent length deduction for all elbows, terminations, etc. If the information is not readily available from the vent manufacturer, use the Vent Fitting Equivalent Length chart below to find the total equivalent length for all vent fittings in your combustion air system. Then subtract this number of feet from the total equivalent length allowed in Maximum Category IV Vent Equivalent Length chart above. The sum of this calculation is the maximum length of straight vent allowed. If a longer length is required, repeat the calculation using a larger vent size. When using this chart, no additional deduction is required for the addition of the vent system terminal.

Vent Fitting Equivalent Length				
Vent Pipe:	6" Vent	7" Vent	8" Vent	9" Vent
90° Elbow	8 feet	9 feet	10 feet	11 feet
90° Long Radius Elbow	5 feet	5 feet	5 feet	6 feet
45° Elbow	5 feet	5 feet	5 feet	5 feet

The following vent information is provided for use in design calculations, if needed.

Venting Specifications		
Input MBtu	Combustion Air Volume (cfm)	Max Vent Press. "W.C.
399	136	0.5
500	170	0.6
750	255	1.0
900	306	1.2
1000	340	1.3

### 9.3 Vertical or Horizontal Vent Termination:

1. The vent terminal must have a minimum clearance of 4 feet (1.22 m) horizontally from, and in no case be located above or below, unless a 4 foot (1.22 m) horizontal distance is maintained from electric meters, gas meters, regulators and relief equipment.
2. The vent cap must terminate at least 3 feet (0.91 m) above any forced air inlet within 10 feet (3.05 m).
3. The vent shall terminate at least 4 feet (1.22 m) below, 4 feet (1.22 m) horizontally from or 1 foot (0.3 m) above any door, window or building air inlet to the building.
4. The vent system shall terminate at least 1 foot (0.3 m) above grade and at least 1 foot (0.3m) above possible snow accumulation levels and shall terminate at least 7 feet (2.13 m) above grade when located adjacent to public walkways or gathering areas.
5. To avoid a blocked flue condition, keep the vent cap clear of snow, ice, leaves, debris, etc.
6. The vent must not exit over a public walkway, near soffit vents or crawl space vents or other areas where condensate or vapor could create a nuisance or hazard or cause property or could be detrimental to the operation of regulators, relief valves or other equipment.
7. A horizontal vent must extend one foot beyond the wall.
8. A horizontal vent terminal must not be installed closer than 3 feet (0.91m) from an inside corner of an L-shaped structure.
9. A vertical vent must exhaust outside the building at least 3 feet (0.91m) above the point of the exit and at least 2 feet (0.61 m) above the highest point of the roof within a 10-foot (3.05 m) radius of the termination.
10. A vertical termination less than 10 feet (0.91 m) from a parapet wall must be a minimum of 2 feet (0.61 m) higher than the parapet wall.

### 9.4 Combining Category IV Vents

Combined TRICON Category IV gas vent systems must incorporate an Exhausto or Tjernlund variable speed, modulating, mechanical draft inducer capable of maintaining the appropriate negative draft at the end of the common flue, to assure that all water heaters in the combined vent system operate with a negative draft. **Do not exceed negative 0.25" W.C.** See "Combining Vents with a Draft Inducer" illustration below.

**WARNING:** Do not connect multiple water heaters vents into a single unpowered or fixed speed powered vent. This could cause unsafe operation and the potential for poisonous carbon monoxide to enter occupied areas. Such improper installation can cause property damage, personal injury, exposure to hazardous materials or loss of life.

### Conventional Venting

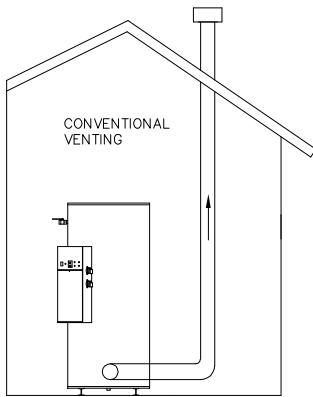

### Through the Wall Venting

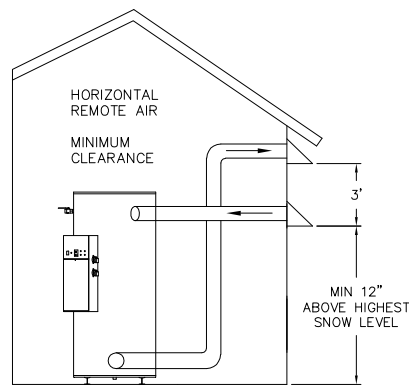

### Combining Vents with a Draft Inducer

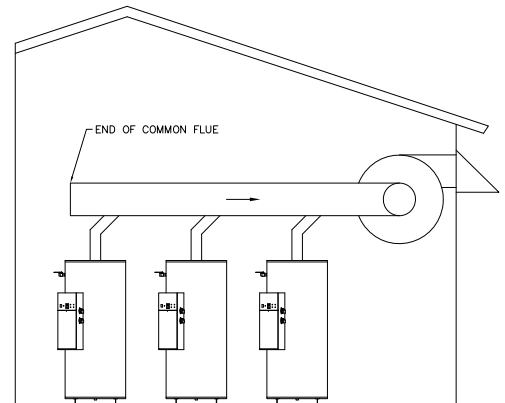

## 10 OPERATING AND SAFETY CONTROLS

**WARNING:** Turn off all electrical service to the appliance when accessing the limit or other controls located inside the control cabinet. This cabinet contains High Voltage wiring and terminals. If the electrical service is not turned off and these terminals are touched, a dangerous shock causing personal injury or loss of life could occur. Close and fasten the control cabinet cover before restoring electrical service to the appliance.

### 10.1 Temperature and Pressure Relief Valve (s)

A Temperature and Pressure Relief Valve(s) sized in accordance with the ASME Boiler and Pressure Vessel Code is installed in the tank.

**WARNING:** Secure the relief valve pipe to a suitable floor drain such that very hot water does not openly splash during a significant relief valve discharge. If the relief valve pipe is not routed and secured to a suitable drain, hot water discharge can result in property damage, scalding and personal injury or loss of life.

- The drain pipe may not be smaller than the relief valve opening and must be secured to prevent it from lifting out of the drain under discharge pressure.
- **CAUTION: Do not install a reducing coupling, valve or other restriction in the T&P relief valve(s) discharge line.** The discharge line shall allow complete drainage of the valve and line. Relief valves should be manually operated at least once a year.
- Thermal Expansion - A relief valve that periodically discharges may result from thermal expansion, if the water heater is installed in a system closed by components, such as a backflow preventer or check valve in the cold water supply. These systems must be provided with means to control expansion. Contact a water heater or plumbing professional to resolve this situation.
- **CAUTION: Do not plug the relief valve, as this will eliminate the critical water temperature and pressure protection it provides.**

### 10.2 Operating Temperature Control

An adjustable digital operating control is located in the front control panel. The control is factory pre-set at approximately 120 F. To adjust the setpoint to deliver the desired water temperature, press and release the Set 1 key on the face of the control. When setpoint adjustment is enabled, use the arrow keys to adjust the set point to the desired system temperature. See TempTrac Electronic Controller Panel in this manual for more information.

### 10.3 High Water Temperature Limit Control

Appliances are equipped with adjustable limit and high limit controls to control the maximum discharge water temperature. These controls are located inside the control cabinet and are accessed by removing the bottom cover. The high limit control is optionally available as the manual reset type and may be reset by pressing the limit reset button accessible through the control panel cover. Pressing the reset on the High Limit Control will not cause the control to reset until the water temperature has dropped below the set point of the manual reset High Limit Control. The Lower Limit is of the auto reset type and can be dial adjusted to operate just above the set point of the main Operating Temperature Control.

### 10.4 Cathodic Protection

PVI water heaters do not utilize cathodic protection. However, in hot water systems utilizing cathodic protection, hydrogen gas can be produced when the hot water system has not been used for a long period of time (generally two weeks or more). **Hydrogen gas is extremely flammable.** To prevent the possibility of injury under these conditions, one of the hot water system faucets should be opened for several minutes before using any electrical device connected to the hot water system. If hydrogen is present, there will be an unusual sound such as air escaping through the pipe as the hot water begins to flow. Do not smoke, have open flames or turn electrical switches on or off near the faucet at the time it is open.

### 10.5 Electronic Low Water Cut-Off (Optional)

When the water level is above the electrode position in the tank, the reset pushbutton will energize the control (LED will be lit). The control remains energized until the water level recedes below the electrode position (LED will not be lit). Unless otherwise specified, there is a three-second time delay on decreasing level. Water level must be below tank probe location for full three seconds before control de-energizes.

## 11 TEMPTRAC™ ELECTRONIC CONTROLLER PANEL

### 11.1 Principle Of Operation

The water heater operates to satisfy the setpoint of the TempTrac digital control whose sensor is located near the top of the water heater tank. Demand (flow) will typically create a drop in temperature, thus activating the water heater to add heat to the stored water. This setpoint is the desired water temperature to maintain.



### 11.2 Lower Led Readout

The default display of the lower readout (Probe 1) is the stored water temperature sensed near the top of the water heater tank. This is used to regulate the temperature of the water heater.

### 11.3 Upper Led Readout

The default display of this readout will display “nu”. This readout can display a temperature reading from a 2<sup>nd</sup> probe. The 2<sup>nd</sup> probe can be installed in a thermal well (this optional probe and thermal well, with heat conductive paste, is custom and must be ordered from your PVI representative or directly from PVI) to remotely monitor water temperatures, such as blended water temperature, downstream of a thermal mixing valve or a remote storage tank. Both Probe 1 and Probe 2 temperatures are available for monitoring through the optional MODBUS RTU interface.

### 11.4 Control Buttons

<b>SET</b>	Displays and modifies the temperature set points. In programming mode, it selects a parameter or confirms an operation.
<b>UP</b>	Displays and modifies the energy saving (Night Time setback) settings. In programming mode, it browses the parameter codes or increases a displayed value.
<b>DOWN</b>	Displays the working hours of the load relays. In programming mode, it browses the parameter codes or decreases a displayed value.
<b>CLOCK</b>	Changes lower display from the stored water temperature to current time and day.
<b>EXT</b>	Changes upper display from Probe 2 temperature to Probe 3 temperature (when installed). Also displays the temperature difference of the stored water temperature minus Probe 2 temperature. In programming mode it sets the 4-20mA output (password is required).
<b>ON/OFF</b>	Switches the control ON or OFF.

(See TempTrac User Manual PV500-40 for full description)

### 11.5 To View The Setpoint

- Push and release the **SET** key to see the set point value.
- To return to normal display, press **SET + UP** or wait 15 seconds without pressing any key.

### 11.6 To Change The Setpoint

- Push the **SET** key. The upper display will show the “St1” parameter name, while the lower display will show its value.
- Use the **UP** or **DOWN** key to cycle through the parameter names.
- Push the **SET** key to modify a parameter value. The value starts flashing in the lower display.
- To change it push the **UP** or **DOWN** keys. Push the **SET** key again to confirm the value and pass to the setting of next set point.
- Repeat the operations described at points 3, 4, 5.
- **To Exit:** press **SET + UP** or wait 15 seconds without pressing any key.

**NOTE:** Each point has a time out of 15 seconds. If any key is pushed within 15 seconds the controller exits the set points programming procedure.

**NOTE:** The set value is stored even when the procedure is exited by waiting the time-out to expire.

### 11.7 To Change Other Parameters

- Push the **SET and DOWN** arrow simultaneously for 3 seconds.
- Select the required parameter. The name of the parameter is on the upper display; its value is on the lower display.
- Press the **SET** key: the value of the parameter will start blinking.
- Use **UP** or **DOWN** to change the value.
- Press **SET** to store the new value and move to the following parameter.
- **To Exit:** Press **SET + UP** or wait 15s without pressing a key.



## 11.8 LED Display Alarm Messages

Alarm messages are displayed in the upper LED readout and alternate with the default display. An alarm LED ICON is also illuminated. (See TempTrac User Manual PV500-40 for full description.)

ALARM MESSAGE	CAUSE	RESULTS OF ALARM CONDITION	RECOMMENDED ACTION
"P1"	TP1 probe failure	Inlet temperature sensor is not connected or is reading incorrectly. Call for heat and burner modulation output signal will revert to low fire.	Check wiring and sensor Terminals 14 & 17
"P2"	TP2 probe failure	Temperature sensor is not connected or is reading incorrectly.	Check wiring and sensor Terminals 15 & 17
"P3"	TP3 probe failure	Temperature sensor is not connected or is reading incorrectly or flue gas temperature protection is disabled (if used).	Check wiring and sensor Terminals 16 & 17
"HA"	High temperature limit setpoint exceeded	Buzzer sounds, operation continues	Manual reset required
"LA"	Low temperature alarm	Buzzer sounds, operation continues	
HP	Digital input 3 is activated for one or more of the following: Flame failure or any control component failure, if equipped with alarm on any failure option	Unit de-energized after timer delay	Manually reset required
LP	Digital input 2 is activated	Unit de-energized after timer delay	Manually reset required
Mn1	Maintenance alarm for output 1	Buzzer sounds, operation continues	Check wiring and sensor
Mn2	Maintenance alarm for output 2	Buzzer sounds, operation continues	Check wiring and sensor
Mn3	Maintenance alarm for output 3	Buzzer sounds, operation continues	Check wiring and sensor
"rtc"	The real time clock has lost its setting	Energy saving function disabled	Reprogram clock

## 12 REMOTE CONNECTIONS – TERMINAL STRIP

### 12.1 Making BMS/BAS remote connections for analog and binary (on/off) signals

A terminal strip for the remote connection is located behind the hinged control panel at the top of the cabinet and is accessed by removing the bottom cover and then removing the screws at the top of the hinged cover.

**Important:** Do not use single strand bell wire for remote field connections to terminals R1-R2 and C1-C2. Use only multi-strand copper wire. See table below for wire length and gauge:

Wire Gauge	18 GA	16GA	14 GA	12 GA
Maximum Length	30 FT	50 FT	75 FT	100 FT

**WARNING:** Turn off all electrical service to the appliance when accessing the remote connections located inside the control cabinet. These terminals are High Voltage. If the electrical service is not turned off and these terminals are touched, a dangerous shock causing personal injury or loss of life could occur. Close and fasten the control cabinet cover before restoring electrical service to the appliance.

## 12.2 The Following Describes The Functions Of Each Of These Terminals And The Factory-Installed Options Required To Activate The Terminals:

**Note:** Terminal **P1-P2** are functional only when the water heater is equipped with the factory installed options required to activate the terminals. Terminals **R1-R2**, **A1-A2**, **C1-C2** and **T1-T2** are standard pre-wired functions on all models.

**R1-R2:** Used to activate / de-activate water heater from remote master control.

Terminals are wired to a relay in a remote Energy Management System. When relay closes, circuit from R1 to R2 is completed and appliance controls are enabled. Appliance ships from factory with jumper between terminals. Remove jumper when connecting to a remote controller.

**A1-A2:** Used to activate a remote alarm, signaling shutdown of combustion control.

Provides a maximum 10 amp relay contact closure when the flame safeguard terminates combustion due to a tripped safety interlock (i.e.: air proving switch, high limit switch, low water flow switch or flame sensor, etc.).

**P1-P2:** Activates remote equipment and requires confirmation signal back to the appliance.

Provides a maximum 10-amp relay contact closure to activate a remote device (i.e.: mechanical room air louvers, draft inducer or power vent, etc.). The remote device must send return signal via proving switch to confirming proper operation to terminals C1-C2, prior to the appliance being able to energize. **Options Required - Consult Factory.**

**C1-C2:** Used for proving operation of remote device.

Terminals are wired to a proving switch on a remote device such as a power venter. When relay closes, circuit from C1 to C2 is completed and appliance controls are enabled. This appliance ships from the factory with jumper between terminals.

**T1-T2:** Used for external modulation control.

To connect external modulation control, disconnect and cap the blue wire connected to terminal T2 and connect the external modulating signal to terminals T1 (positive) and T2 (negative).

## 13 SEQUENCE OF OPERATION

### 1. Incoming 120VAC

- a. Full time power to the Main Control Switch
- b. Full time power to the Variable Frequency Drive

### 2. Power On - When the main control switch is turned on:

- a. 120v is applied to the step-down transformer (24v)
- b. 120v is applied to the L.W.C.O. terminal L1 (if used)
- c. 120v is applied to the Fenwal Flame Safeguard Control
- d. 24v is applied to the TempTrac operating temperature control terminal L1

### 3. Call For Heat - If the TempTrac operating control senses a call-for-heat condition:

- a. The High Gas Pressure and Low Gas Pressure Switch (both optional) are energized and their safe condition is proved.
- b. The thermostat contact on the Fenwal Flame Safeguard Control is energized.
- c. The flame control will then verify the Airflow-Proving Switch is in the open position, which must exist before the blower is powered.
- d. Energizing the blower should close the airflow proving switch. If the airflow-proving switch is not in the closed position, the flame control's fan terminals F1-F2 will power the Variable Frequency Drive (VFD) blower system at low speed for pre-purge.
- e. If the airflow-proving switch does not close following the blower being energized, the flame control will lockout.

4. **Proof of Air Pressure Switch** - The control will look for a signal from the airflow-proving switch, indicating that the blower is operating:
  - a. When the airflow generated by the blower is sufficient to cause the differential air switch to close, the 15 - second pre-purge delay will start.
  - b. During this period any flue products or combustible gases which may have settled in the water heater are evacuated.
5. **Heat-Up** - Following the pre-purge delay, the hot surface igniter will be energized:
  - a. The flame control will monitor the current applied to the hot surface igniter.
  - b. If the flame control determines the proving current meets the threshold, a dwell time delay starts to assure the hot surface igniter has sufficient time to reach ignition temperature.
6. **Ignition** - When dwell time is completed a 4-second Trial for Ignition (TFI) period is initiated:
  - a. The Delay-On (Low Fire Hold) Relay and the Gas Safety Valves are energized.
  - b. During TFI the flame safeguard control will monitor the flame using flame rectification through the hot surface igniter.
  - c. If the flame control senses the presence of flame before the end of the TFI period, the igniter will be de-energized and the flame control will continue to monitor the flame, through the igniter, until the operating thermostat ends the call for heat condition.
7. **Loss of Flame Signal**
  - a. If the igniter fails to sense flame at any time, the igniter and gas valve will be de-energized and the flame control will reset and begin the call-for-heat sequence again. This will occur 3 times (one time if CSD-1) before the flame control will lockout.
  - b. When the call for heat condition ends or flame failure occurs following the third TFI period (one time if CSD-1), a 30-second post-purge period will begin. This period of blower operation will exhaust any remaining combustion products from the system.
8. **Delay-On Relay** - Once the Delay-On (Low Fire Hold) Relay has timed out, it energizes the Modulation Release Relay (SPDT) to enable the analog signal from the TempTrac to the VFD to regulate the speed of the blower.
  - a. The TempTrac will continue to monitor the stored water temperature in the tank.
  - b. When the setpoint temperature is reached the call-for-heat signal to the flame safeguard control is discontinued.
  - c. The flame safeguard control deenergizes the VFD blower system and the gas valve, thereby suspending burner operation.
  - d. As heat is transferred to the building, the water heater loop temperature will fall below the set point. The TempTrac will sense this condition and begin the call-for-heat sequence again.
9. **Flame Safeguard LED Diagnostic Indicator** - If the Fenwal Flame Safeguard Control at any time during the operating sequence senses an improper operating state and locks out, the diagnostic red LED located on the control board will flash to indicate one of the following conditions exist:

LED INDICATION	FAULT MODE
On	Normal Operation
OFF	Internal Control Failure – check power
1 Flash	Airflow Fault
2 Flashes	Erroneous Flame Signal
3 Flashes	Ignition Lockout
4 Flashes	Hot Surface Igniter Fault
5 Flashes	Low Voltage (24 VAC)
6 Flashes	Valve Relay Problem

## 14 INITIAL STARTUP

### 14.1 Initial Startup Requirements

Installation should be complete prior to performing initial startup; and the startup must be complete prior to placing the water heater into service. Starting the water heater without proper piping, combustion air, venting or electrical systems can be dangerous and may void the product warranty. The following startup instructions should be followed precisely in order to achieve safe and efficient operation to assure trouble-free service life.

**WARNING: Proper startup must be made by a qualified installer or service agency, who must read and follow the supplied instructions and appliance markings. Failure to complete proper startup before use, tampering with controls or not following all instructions and markings may damage this equipment, void the warranty and may result in property damage, personal injury or death.**

A Start-up Form is included with each product and must be completed by the qualified installer or service agency conducting the startup and must be returned to the manufacture to register the warranty. Copies are available at [www.pvi.com](http://www.pvi.com).

**WARNING: Turn off all power to the water heater when servicing or accessing the blower drive. The blower drive still has power when appliance switch is off. Failure to turn off all power to the water heater can cause personal injury, property damage or loss of life.**

### 14.2 Tools and Instrumentation Required Resources

- Stack Temperature Gauge
- Stack Draft Gauge
- Electronic Combustion Analyzer
- Manometer for checking gas pressure (2 minimum)
- AC/DC Multi-meter (with 20,000 OHM/Volt rating)
- Amp Meter
- Normal Hand Tools

### 14.3 Resources

- Product Installation & Maintenance Manuals
- Start-up Report with instructions
- Local, State, & Federal Codes
- Toll Free 24-Hour Technical Support: 1-800-433-5654

### 14.4 On Site Considerations

- Electrical Supply in accordance with Nameplate Rating
- Uncontaminated Combustion Air
- Adequate Fuel Supply
- Treated Water Supply (Water heaters)
- Consistent Draft

### 14.5 Startup Procedure

- 1 Carefully study the burner start-up information included in this manual.
- 2 Fill system tank with water. Some water appliances may be equipped with an optional air vent. If venting through the safety valve when filling the appliance, insure gags or fixtures are removed from the safety valve prior to start-up. Open the safety valve to allow air in the tank to escape.
- 3 Be sure all connections into the tank are tight, as leaks at tank fittings will damage the insulation.
- 4 **CAUTION: Conduct the following gas train leakage test before start-up, at annual intervals and prior to investigating the cause of any reported occurrences of delayed ignition.**
  - a. Using an appropriate bubble detection solution, thoroughly coat all gas train pipe connections. If any bubbles are detected, the leaking connection must be tightened, recoated, and rechecked to assure stoppage of the leak.

- b. Attach a manometer to measure the gas pressure at the manual gas shutoff valve located just upstream of the gas train. Adjust gas train inlet pressure to the specified value (e.g. 14" W.C.), and tightly close the gas train manual shutoff valve closest to the burner.
  - c. Reattach the manometer to the gas train manual shutoff valve at the burner and record the measured gas pressure in inches of water column (W.C.). Measure gas pressure again after 15 minutes. If gas pressure has increased 0.5" W.C. or more, the gas leak must be isolated to one or more of the operating gas valves. (For example, a solenoid actuated gas shutoff valve.) After any leaking valve is replaced, the reassembled gas train must be leak tested again before start-up is attempted.
5. Remove enclosure panel cover on the appliance to expose control circuit. A wiring diagram, included in this packet, will show the controls used in our circuitry.
  6. Visually check that all components are intact and no damage has occurred during transit.
  7. Check all connections within the control cabinet. A loose connection could cause intermittent shutdowns.
  8. All burners will use a hot surface igniter (HSI) as the ignition source. They may use a single gas pressure regulator and valves, valve regulator combinations or multiple gas trains.
  9. Connect a test meter to the control for reading the flame response signal.

**NOTE:** Some flame controls read the flame signal in micro amps and some in volts DC.

10. **CAUTION: Be sure the tank is filled with water. Dry firing can destroy the appliance.**
11. Check the inlet gas pressure before start-up, using a manometer or a 0 to 28" W.C. pressure gauge for inlet gas pressure. (This is the pressure measured before all components in the gas train.) This manometer must stay connected throughout the testing, as the inlet pressure must be monitored during the firing of the burner. Record static pressure; it must not exceed 14" W.C. Pressures above this could cause damage to the diaphragm in the gas valve or pressure regulator.
12. Connect a second manometer to the manifold test port at the shutoff valve closest to the burner.
13. **Turn-off main gas shutoff valve.**
14. **Disable or jumper out any BMS/BAS control interface to allow independent setup and adjustment of each water heater.**
15. Turn unit on using the rocker switch on the front of the control enclosure assembly. When the burner fails to light, the flame control will lockout.

Start the burner in Low Fire (Burner combustion must be optimized at both Low and High Fire). To set the TempTrac control for manual modulation output:

- Push and hold the **EXT** key for more than 3 seconds. The **MM** LED switches ON and the **PS4** parameter is displayed in the upper display, while the **PAS** label is shown in the lower display.
- Release the key, and insert the password: **3-2-1**. The value of the modulation parameter PS4 will be displayed in the lower display. **(nu)** stands for not used. Return to this condition for automatic operation.
- To adjust modulation manually, push the **SET** key, the value starts flashing. Then use **UP** or **DOWN** keys to modify it. **100 = High Fire; 0 = Low Fire.**
- To exit, press **SET + UP** or wait 30s without pressing any key.

**NOTE:** After a modification, it will be possible to enter the Modulation output setting without entering the password for 10min. After this time you will be asked for the password again.

16. **Turn-on main gas shutoff valve.**
17. If the operating control switches are closed, the burner blower should come on and pre-purge begins.
18. If nothing happens, check for a lockout condition and reset it by pushing the flame safeguard reset button. Some safety devices are wired in the operating circuit and may not indicate alarm. If no indication of alarm exists, check gas pressure switches, electronic low water cutoffs (if equipped) and temperature limits.

19. When the blower motor starts, the flame control will check for a positive air flow. If the air switch or blocked filter switch (if equipped) is not made the blower will stay on for a period of time then lockout. To adjust the air-proving switch, turn the adjustment screw counter-clockwise until the air proving light comes on, then turn the screw one turn counter-clockwise. The blocked filter switch (if equipped) should only be adjusted when the filter is new. This switch should be turned clockwise until switch makes and then two additional turns. If the gas valves open and close intermittently during normal operation, adjust pressure switches to increase the operational threshold until this condition ceases. This procedure should be followed with every burner.
20. After the pre-purge, the flame control energizes the HSI for the heat up period, approximately 30 seconds. At the end of that period the gas valve is opened for approximately 4 seconds. After the burner has lit and the primary safety control senses a flame, the burner will remain on until the call for heat is satisfied or operation is interrupted by a safety device.
21. If the burner fails to light, the flame control will lockout. When this happens press the reset button on the front of the control to recycle burner and check for improper combustion or weak flame signal as a possible cause.
22. Once the main burner flame is established the firing rate will be controlled by the TempTrac control. Refer to TempTrac manual PV500-41.

#### Burner Combustion Adjustment

Burner combustion should only be adjusted using a combustion analyzer. Do not attempt to adjust burner by sound or sight. With the burner firing, insert the combustion analyzer probe in the flue vent approximately two feet from the appliance. **See Gas Train Illustration below for details.**

With the burner firing and adjusted to low fire, adjust the regulator screw clockwise to increase gas flow or counter clockwise to decrease flow. The desired CO<sub>2</sub> in the combustion products should be between 8.0 and 9.0% for natural gas, 9.5% to 10.5% for LP gas. Do not attempt to adjust combustion based on manifold pressure alone. Manifold pressure should only be used as a reference point.

- a. Once the desired combustion is achieved at low fire, raise the burner firing rate to high fire. Adjust the valve orifice clockwise to reduce the flow of gas and counter-clockwise to increase the flow of gas in order to maintain the desired CO<sub>2</sub> in the combustion products between 8.0 and 9.0% for natural gas, 9.5% to 10.5% for LP gas.
  - b. When high fire combustion has been reached and combustion is within the proper range, return to low fire to confirm settings again.
  - c. **CAUTION: If at any point of the modulation range, carbon monoxide is in excess of 300ppm, contact PVI Industries customer service for assistance.**
23. Enable or reconnect any BMS/BAS control interface removed prior to the setup and adjustment of each water heater.

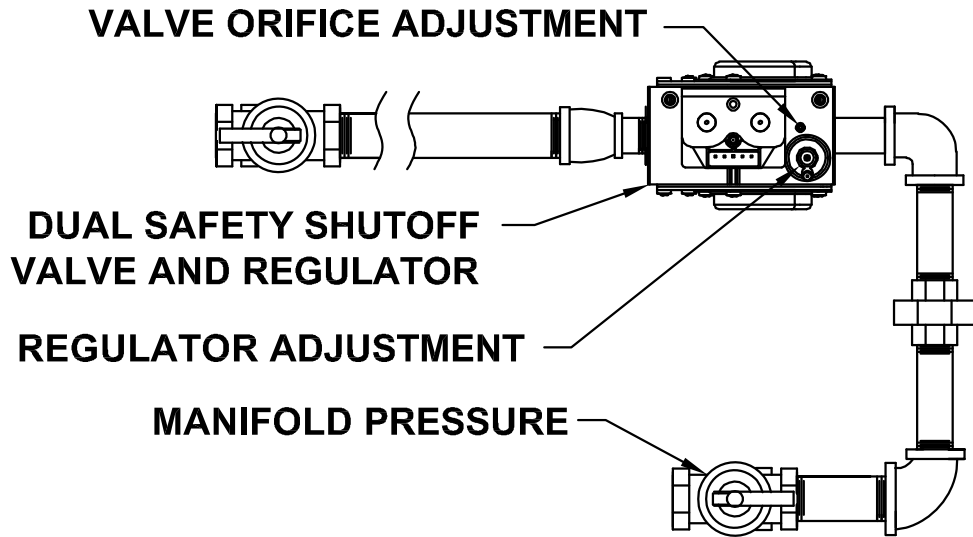

**Gas Train Illustration for Models 40 through 50**  
 (Optional components may not be shown)

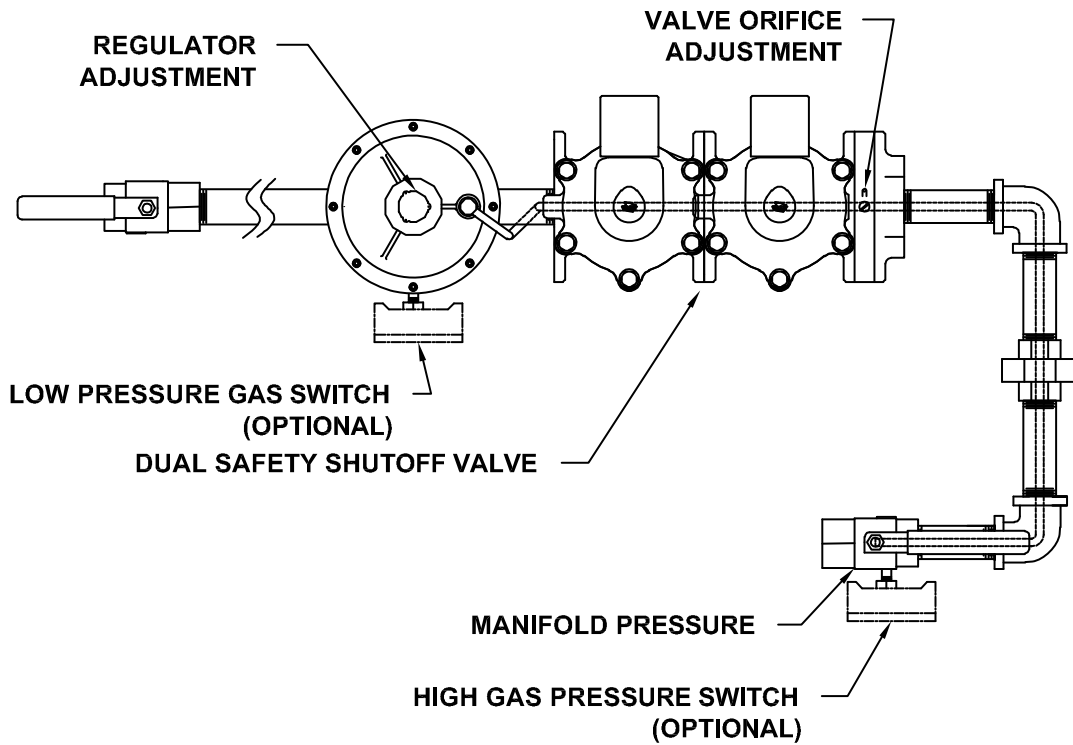

**Gas Train Illustration for Models 65 through 100**  
 (Optional components may not be shown)

15 TROUBLESHOOTING GUIDE

Problem	Probable Cause	Corrective Action	
Starting or Pre-purge Failure	Power Supply	Check fuse and/or circuit breaker. Check voltage at 120/24V step-down transformer.	
	On-Off Switch	Check if On-Off switch is lighted	
	Temperature Control	Check that the operating temperature control is set higher than the temperature of the water heater.	
	Flame Safeguard Control	Check for bad ground or bad control. Replace if necessary.	
	Remote enable/disable open	Enable water heater or place jumper between terminals R1-R2.	
	Combustion Air blower		Check if fan connection terminals on flame control is closed
			Check for 24V at field access terminal C2. Remote interlock may be open.
			Fan VFD may be defective. Verify proper voltage.
	Air-proving Switch		Check switch contacts are closed.
			Check for 24V at the N.O. side of air switch
Check for 24V at the common side of air switch			
Check for proper blower pressure setting – adjust if required. Air switch may be defective.			
Blocked Filter Switch (if equipped)		Check for 24V at the N.C. side of the blocked filter switch. Replace filter or switch as required.	
Flame Control Pressure Switch		Check for 24V at the pressure switch terminal.	
Loose Wire Connections		Check connections to all components	
Flame Failure	Power Supply	Check fuse and/or circuit breaker. Check voltage at 120/24V step-down transformer.	
	Flame Safeguard Control	Check for bad ground or bad control. Replace if necessary.	
	Hot Surface Igniter	Check amp draw during heat-up. Replace if amps greater than 3.1A. Check for overheating condition due to damaged refractory around igniter.	
	Air-proving Switch	Check if switch is bouncing. Adjust or replace.	
	Gas Pressure	Check for proper inlet static and dynamic gas pressure.	
	Combustion	Inadequate flame signal may result from improper combustion. Adjust to proper CO2 levels at low fire.	
	Grounding	Check for proper ground from flame control to burner housing.	
	Safety Limits	Check all safety limits for fault condition and correct as required.	



# REPLACEMENT PARTS



**16.2 Control Panel Components**  
**(Optional components may not be included)**

Key No.	Part No.	Description	Qty.	U/M
1	101947	CONTROL, HOT SURFACE IGNITION FENWAL	1	EA
2	-	CONTROL, TEMPERATURE TEMPTRAC	1	EA
3	-	DRIVE, VARIABLE FREQUENCY AC EMERSON	1	EA
4	5613	FUSEHOLDER, PANEL TYPE #HTB-28I	1	EA
5	5742	FUSE, MDA 15 AMP BUSS 250V NO SUBSTITUTE	1	EA
6	113915	LWCO, PROTODESIGN #LW-3-C-1-A-03	1	EA
7	58154	PROBE, LWCO WARRICK #3L1D002.75 W/1/8 MPT 316 SST	1	EA
8	102163	PROBE, THERMOSTAT DIXELL #18NB-NTC-25FT NICKEL BRASS	1	EA
9	105266	PROBE, THERMOSTAT DIXELL #50DSS-NTC-1.5M SST	1	EA
10	116458	RELAY, SPST 30A 24V OMRON #G7L-1A-TUB-J-CB-AC24 N.O.	*	EA
11	102835	RELAY, TIME DELAY ON SSAC #TDU3000A 24-120 VAC/DC 1 TO 102	*	EA
12	70565	SWITCH, CARLING #LTILA51-6SBLAM-NBL/125N/INDP BLACK W/AMBER	1	EA
13	70573	SWITCH, SPST N.C. MOMENTARY CONTACT SELECTA #SS229	*	EA
14	75908	SWITCH, SPST N.O. MOMENTARY CONTACT SELECTA #SS228	*	EA
15	73495	PKG, THERMOSTAT, JUMO #60/60002277 85-180 DEG 3.3 FT CAP	1	EA
16	73498	PKG, THERMOSTAT, JUMO 200 DEG AUTO 3.3 FT CAP STRPKG,	1	EA
17	109827	TRANSFORMER, CONTROL GE #9T58K2876 .150KVA 120/240V 12/24V 60 HZ	1	EA
18	75842	FUSE, MDA 6 AMP BUSS 250V	1	EA

\* Contact factory for more information

### 16.3 Burner Assembly

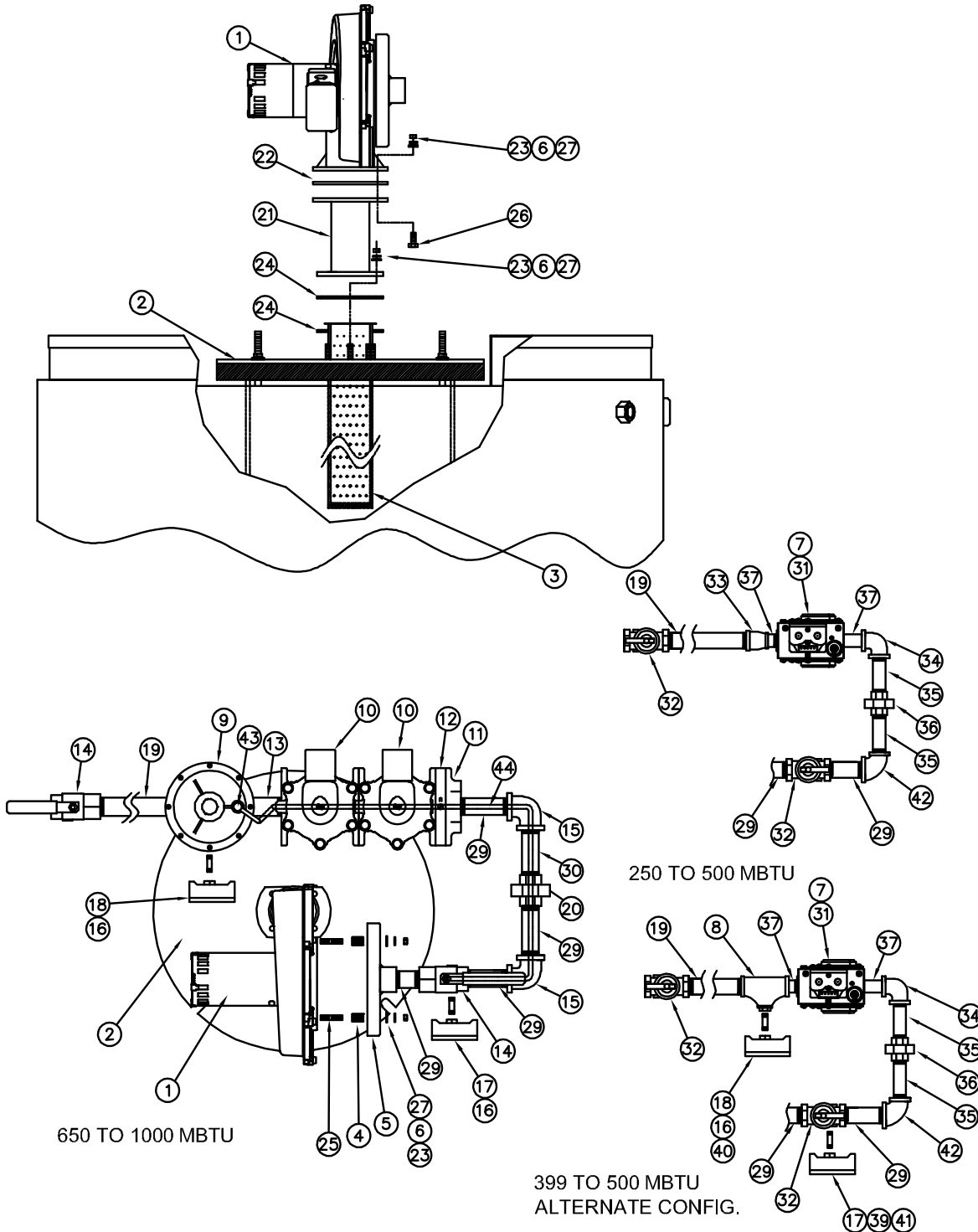

Optional components may or may not be shown

**16.4 Burner Assembly Components**  
**(Optional components may not be included)**

Item No.	Qty.	PVI Part No.	Description
1	1	111876	BLOWER, FASCO #70430069
2	1	*	ASSY, BULKHEAD REFRACTORY
3	1	*	BURNER, METAL PUNCHED
4	6	114513	SPACER, NYLON 1/4 ID X 1/2 OD X 11/16 MCMASTER C
5	1	115248	ASSY, INTAKE GAS AIR 7 OD X 1 NPT
6	14	3494	WASHER, LOCK 1/4 PLT
7	*	110698	HARNESS, WIRING DUNGS FOR TYPE GB-ND 057
8	1	47384	TEE, BLACK 1 X 3/4 X 1/2
9	*	79524	REGULATOR, 1 DUNGS #FRG710/6 ZERO GOVERNOR PROP
10	*	115769	VALVE, GAS 1 ASCO #JB8214250 24V 60AC
11	1	115770	FLANGE, ADAPTER 1 OUTLET ASCO #296658-002
12	2	115786	SHUTTER, VALVE ASCO #HV426038001 1 TO 1 1/2 INCH
13	1	6011	NIPPLE, BLACK 1 X 2
14	2	52823	VALVE, SHUTOFF 1 GAS COMBU #55350 MODEL #840S
15	2	6163	ELL, BLACK 90DEG 1
16	*	5973	NIPPLE, BLACK 1/4 X 2
17	*	101216	SWITCH, PRESSURE HGP-G ANTUNES #8101111202 2 - 20 W
18	*	101201	SWITCH, PRESSURE LGP-G ANTUNES #8103116202 1 - 20 W
19	1	*	NIPPLE, BLACK 1
20	1	5929	UNION, BLACK 1
21	1	115255	ASSY, BURNER EXTENSION 2 X 5 FASCO MOD 43
22	1	113571	GASKET, BLOWER OUTLET 4.665 ROUND AMORIM #CR-55R 1
23	14	3475	NUT, HEX 1/4 X 20 NC STEEL ZINC PLT
24	2	107449	GASKET, FLANGE BLOWER 1/8 #23 CRANGLAS
25	6	115745	STUD, THREADED 1/4 X 20 NC X 2 CRS GRAINGER #4REW2
26	6	55854	BOLT, 1/4 X 20 NC X 1 PLT HEX HEAD GR 5
27	14	15607	WASHER, FLAT 1/4 PLT
29	*	6012	NIPPLE, BLACK 1 X 3
30	*	6014	NIPPLE, BLACK 1 X 4
31	*	109843	VALVE, GAS 3/4 DUNGS #252605 TYPE GB-ND 057 24VAC
32	2	5337	VALVE, SHUTOFF 1 KEY GAS #223-122111
33	1	46311	REDUCER, BELL BLACK 1 X 3/4
34	1	6160	ELL, BLACK 90DEG 3/4
35	2	5992	NIPPLE, BLACK 3/4 X 3
36	1	5928	UNION, BLACK 3/4
37	2	5991	NIPPLE, BLACK 3/4 X 2
38	1	5993	NIPPLE, BLACK 3/4 X 4
39	*	5969	NIPPLE, BLACK 1/8 X 2
40	*	6109	BUSHING, BLACK 1/2 X 1/4
41	*	6106	BUSHING, BLACK 1/4 X 1/8
42	1	6164	ELL, BLACK 90 DEG 1 X 3/4
43	1	6496	ELL, 1/4 MPT X 1/4 COMPRESSION
44	3.500	3299	TUBING, ALUMINUM 1/4

\* Contact factory for more information

## 17 PERIODIC MAINTENANCE

Listed below are items that must be checked to ensure safe reliable operations. Maintenance must be performed by a qualified service or maintenance provider. To ensure proper maintenance, the following instructions should be posted near the appliance and maintained in legible condition. Verify proper operation after servicing.

**WARNING: When servicing the controls, use exact, Factory authorized, replacement parts and label all wires prior to disconnection. Verify proper operation after servicing. Incorrect parts substitution and wiring errors can cause damage, improper operation, fire, carbon monoxide and other unexpected and unsafe conditions that could result in fire, injury or death.**

1. Examine the appliance and venting system at least once a year. Check more often in first year to determine inspection interval.
  - a. Check all joints and pipe connections for tightness, corrosion or deterioration.
  - b. Check the electronic-ignition system for quick ignition and a proper flame signal.
  - c. Check all safety controls including thermostats for proper operation.
  - d. Check safety shut-off valves for operation and tightness.
  - e. Have the entire system, including, but not limited to, the burner, heat exchanger and venting system, periodically inspected by a qualified service agency.
2. Exposure to Dusty or Dirty Combustion Air: An appliance installed in a dust or dirt contaminated atmosphere will require replacement of the filter on a 3 to 6 month schedule or more often, based on severity of contamination. Contaminants can be drawn in with the combustion air. Inadequate combustion air or non-combustible particulate matter such as dust, dirt, dryer lint, concrete dust, dry wall dust or the like can block burner ports and cause unsafe operation and a non-warrantable failure. Do not remove filter without a suitable replacement. To inspect and clean the burner, a qualified serviceman or installer should use the procedures described in item 5 & 6 below.
3. Any sign of soot on the heat exchanger or in the flue indicates the need for a combustion inspection. Properly installed and adjusted units seldom need heat exchanger cleaning. If soot has formed, the most common causes are restricted combustion air or excessive gas. A blocked heat exchanger can cause unsafe operation and will reduce efficiency. To inspect and clean the heat exchanger, a qualified service agent or installer should use the procedures described in item 5 & 6 below.
4. All gaskets on disassembled components must be replaced on reassembly with exact, Factory Authorized, replacement parts only. Gasket kits are available from your PVI Industries<sup>®</sup> Representative or by contacting PVI Industries<sup>®</sup>, LLC.
5. Burner and/or Heat Exchanger Inspection and Cleaning Procedure:
  - a. Turn off main power to unit.
  - b. Turn off gas supply.
  - c. Write notes and/or take pictures during this process to aid in correct reassembly.
  - d. Remove the hot surface igniter, (HSI) from the burner. Be very careful not to bump the igniter element due to the fragility of the igniter.
  - e. Remove the nuts that secure the burner top plate to the burner flange and lift the burner top plate up until it is completely extracted from the burner.
  - f. Inspect top plate refractory for damage. The refractory should provide a tight seal against the top edge of the burner deck. The silicone foam gasket located on the top plate flange should also be checked for damage or excessive compression set.
  - g. With the burner top plate removed, inspect the deck surface of the burner for lent or other blockage carried in the fuel air stream. If blockage has accumulated, use brush to loosen debris and use a vacuum to remove from the burner cavities. Do not brush or scrub the metal fiber burner surface as this can cause permanent damage to the burner material.
  - h. Replace any damaged components and reassemble in reverse order. (4-5 ft/lbs).

- i. Cycle unit and test to verify all safety and operating controls are properly functioning and the burner top plate flange is free of leaks.
6. If equipped, the combustion air filter should be replaced every six months. If filter blockage becomes excessive the filter safety switch will not allow the burner to fire. To avoid nuisance shutdown in dirty environments, check and replace filter more frequently.
7. Inspect low water cutoffs and relief valves for proper operation at every six months, or more often if indicated by inspection.
8. Keep appliance area clear and free from combustible materials, gasoline and other flammable vapors and liquids.
9. Check frequently to be sure the flow of combustion and ventilation air is unobstructed to the appliance.
10. When electrical controls are serviced or replaced refer to ELECTRICAL COMPONENT LOCATIONS for identification and location of components.
11. All replacement parts are available through your PVI Industries® Dealer. If you need assistance identifying or contacting your local dealer, you may contact PVI Industries, LLC directly at the address and telephone number located on the first and last page of this manual.
12. If the appliance is to be shut down for an extended period of time, the primary gas valve and the water supply should be shut off. When the appliance is returned to service, a thorough inspection of all utilities and general appliance condition should be conducted.

## 18 RECOMMENDED MAINTENANCE SCHEDULE

### 1. Annual Maintenance

- a. Check all joints and pipe connections for tightness, corrosion or deterioration.
- b. Check the electronic-ignition system for quick ignition and a proper flame signal.
- c. Check all safety controls including thermostats for proper operation.
- d. Check safety shut-off valves for operation and tightness.
- e. Test flame failure detection system.
- f. Test high limit and operating temperature controls.
- g. Conduct a combustion test.
- h. Perform leakage test on pilot and main gas valves.
- i. Test air switch in functionality.

### 2. Semi-Annually

- a. Recalibrate all indicating and recording gauges.
- b. Check flame failure detection system components.
- c. Check firing rate control.
- d. Check piping and wiring of all interlocks and shutoff valves.
- e. Inspect burner components.
- f. Check igniter.
- g. Test high and low gas pressure interlocks.
- h. If equipped, check air filter and replace if required.

### 3. Monthly Maintenance

- a. Test low-water cutoff device and alarm (if equipped).
- b. Check flue, vent, stack, or outlet dampers.
- c. Check flame signal strength.
- d. Check flame failure detection system.
- e. Check firing rate control.
- f. Listen to and visually check the pilot and main fuel valves.

### 4. Daily Maintenance

- a. Check gauges, monitors, and indicators.
- b. Check instrument and equipment settings.

### 5. As Required

- a. Check drip leg and gas strainers.
- b. Test flame failure detection system.
- c. Test temperature and pressure relief valves in accordance with ASME Boiler and Pressure Vessel Code Sections VI & VII.
- d. Tank flush and cleanout.





