

Haier

LED LCD TV RECEIVER

USER MANUAL

Please read this manual carefully before using your television and keep this manual in a good place for future reference.

MODEL:
LEY26C600
LEY32C600

Contents

01	Safety and warnings	
	Welcome	P.02
	Important information	P.02
	Safety notice	P.03
	Warnings and cautions	P.05
02	Introduction	
	Main Parameter	P.06
	Base Stand Assembly Instruction	P.08
	Wall Mounting Installation Guidelines	P.09
	Control Panel	P.10
	Rear/Side Sockets	P.10
	Connecting your TV	P.11
	Common interface	P.12
03	Remote Control	
	Remote Control	P.13
04	Operation	
	Installation Guide	P.15
05	DVD Operation	
	DVD Side Panel	P.23
	Remote Control-DVD section	P.24
	Meun Operation	P.25
	Protect your DVD discs	P.26
06	DVD Trouble shooting	
	DVD Trouble shooting	P.27
07	Trouble shooting	
	Trouble shooting	P.28
	Specification	P.30

01 Safety and Warnings

WELCOME

Thanks for buying this 26"/32" LED LCD TV with DVD Player. This guide will help you set up and begin using your TV.

First, check the contents of your box with the parts check list below:

26" Full HD 1080P Digital LED LCD TV with DVD Player	32" Full HD 1080P Digital LED LCD TV with DVD Player
Remote control	Remote control
AAA battery x2	AAA battery x2
Instruction Manual	Instruction Manual
Quick start guide	Quick start guide
Scart cable x1	Scart cable x1
Pedestal	Pedestal

Now you can get started!

IMPORTANT INFORMATION

READ ALL INSTRUCTIONS BEFORE USE AND KEEP FOR FUTURE REFERENCE.



CAUTION
RISK OF ELECTRIC SHOCK
DO NOT OPEN



CAUTION

TO REDUCE THE RISK OF ELECTRIC SHOCK, DO NOT REMOVE COVER (OR BACK). NO USER SERVICEABLE PARTS INSIDE. FOR ANY PROBLEMS, REFER SERVICING TO THE CUSTOMER HELP LINE. THERE IS A LIGHTNING ARROW SYMBOL IN THE TRIANGLE: THIS SYMBOL INDICATES HIGH VOLTAGE IS PRESENT INSIDE. IT IS DANGEROUS TO MAKE ANY KIND OF CONTACT WITH ANY INSIDE PART OF THIS PRODUCT.

THERE IS AN EXCLAMATION MARK IN THE TRIANGLE: THIS SYMBOL ALERTS YOU THAT IMPORTANT LITERATURE CONCERNING OPERATION AND MAINTENANCE HAS BEEN INCLUDED WITH THIS PRODUCT.



CAUTION: TO REDUCE THE RISK OF ELECTRIC SHOCK AND FIRE, DO NOT PUT THE TV SET NEAR SOURCES OF HUMIDITY. DO NOT USE ANY ABRASIVE CLEANERS WHICH MAY SCRATCH OR DAMAGE THE LCD SCREEN. AVOID CONTACT WITH OBJECTS THAT MAY SCRATCH THE LCD SCREEN.



NOTE: SERVICING THE UNIT YOURSELF IS UNAUTHORISED AND COULD LEAD TO INJURY OR PRODUCT DAMAGE. REFER ALL SERVICING TO THE CUSTOMER HELPLINE.



VISIBLE AND INVISIBLE LASER RADIATION WHEN OPENED. AVOID EXPOSURE TO BEAM (WARNING LOCATION: INSIDE ON LASER COVER SHIELD).

REGION MANAGEMENT INFORMATION

This DVD player is designed and manufactured to respond to the Region Management Information that is recorded on a DVD disc. If the Region number described on the DVD disc does not correspond to the Region number of this DVD Player, this DVD player can not play that disc.

This Region number of this DVD player is 

This TV is optimised for use in the United Kingdom. It is not certified to work in other countries and some features and signal inputs may not work as described in the documentation.

SAFETY NOTICE

- Warning: To reduce the risk of electric shock, do not remove the cover or back. There are no user-serviceable parts inside. Refer servicing to qualified personnel.



- Warning: To prevent fire or electric shock hazard, do not expose the unit to rain or moisture.

- Do not expose the Adaptor and product to water (dripping or splashing) and no objects filled with liquids, such as vases, should be placed on the unit.

- Keep the product away from direct sunlight and heat source such as radiators or stoves.

- Do not block the ventilation openings. Slots and openings on the unit are provided for ventilation. The openings should never be blocked by placing your product on a cushion, sofa or other similar surface.

- Do not place the product on unstable cart, stand, tripod, bracket or table. The unit may fall, resulting in possible damage or injury.

- Never place heavy or sharp objects on the panel or frame.

- Only use the AC adapter included with product. Using any other adapter will void your warranty.

- Unplug the Power from the outlet when the unit is not in use.

- Attention should be drawn to the environmental aspects of battery disposal.

- WARNING: The battery shall not be exposed to excessive heat such as sunshine, fire or the like.

- WARNING: Excessive sound pressure from earphones or headphones can cause hearing loss.

- WARNING: Only use the attachments/accessories specified provided by the manufacturer, the product is supplied by AC adapter, the AC adapter is used as disconnect device, the disconnect device shall remain readily accessible.

This marking indicates that this product should not be disposed with other household wastes throughout the EU. To prevent possible harm to the environment or human health from uncontrolled waste disposal, recycle it responsibly to promote the sustainable reuse of material resources. To return your used device, please use the return and collection systems or contact the retailer where the product was purchased. They can take this product for environmental safe recycling.



UK Only 13A Plug Connection.

If your TV is connected to the mains supply using a 3 pin 13 amp plug, the voltage rating is 220-240 volts and should be protected by a 3 amp fuse in the plug.

Should the fuse require replacement for any reason, the fuse must be replaced with a fuse rated at 3 amps and manufactured and approved to Bs1362.

If the mains plug is unsuitable for the socket outlet in your home or is removed for any other reason, then the cut off plug should have its fuse removed and be disposed of safely to prevent the hazard of electric shock.

There is a danger of electric shock if the cut off plug is inserted into any 13 amp socket outlet.

How to wire a 13 amp plug.

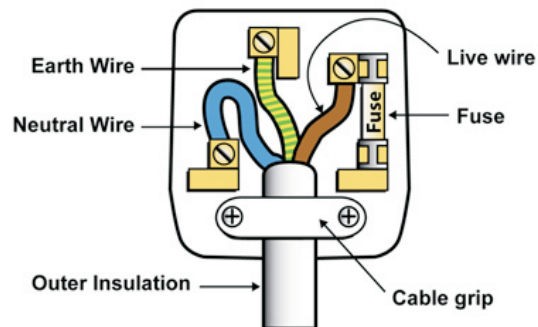



Important

The wires in the mains lead on a TV are colour coded in accordance with the following code.

Green and yellow	Earth	Not required on TV's as they are double insulated.
Blue	Neutral	
Brown	Live	

Double insulated appliances

Appliance with double insulation, have a symbol  than means that they do not have an earth wire (green and yellow), so on these appliances only have two wires a blue and a brown. If the colours do not correspond with the markings identifying the terminals in your plug, proceed as follows.

The green and yellow wire, not required on double insulated appliances, must be connected to the terminal in the plug which is marked with the letter E or with the earth symbol  or coloured green and yellow.

The blue wire must be connected to the terminal marked N or coloured Blue or Black

The brown wire must be connected to the terminal marked L or coloured Brown or Red

WARNINGS AND CAUTIONS



Warning ⚡

High voltages are used in the operation of this television receiver. Do not remove the cabinet back from your set. Refer servicing to qualified service personnel.

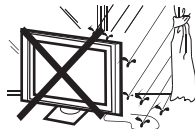

Warning ⚡

To prevent fire or electrical shock hazard, do not expose the television receiver to rain or moisture.



Warning ⚡

Do not drop or push objects into the television cabinet slots or openings. Never spill any kind of liquid on the television receiver.



Caution ⚠

Do not block the ventilation holes in the back cover. Adequate ventilation is essential to prevent failure of electrical components.



Caution ⚠

Do not trap the power supply cord under the television receiver.

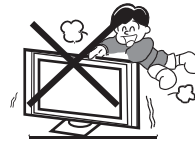

Caution ⚠

Never stand on, lean on, or suddenly push the television or its stand. You should pay special attention to children. Serious injury may result if it should fall.



Caution ⚠

Do not place your television on an unstable cart, stand, shelf or table. Serious injury to an individual, and damage to the television, may result if it should fall.



Caution ⚠

When the television receiver is not used for an extended period of time, it is advisable to disconnect the AC power cord from the AC outlet.

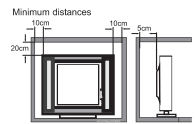

Caution ⚠

If the television is to be built into a compartment or similar enclosure, the minimum distances must be maintained. Heat build-up can reduce the service life of your television, and can also be dangerous.

02 Introduction

CAUTION

Never tamper with any components inside the TV, or any other adjustment controls not mentioned in this manual. All LED-TVs are high voltage instruments. When you clean up dust or water drops on the LED PANEL or CABINET, the power cord should be pulled out from the receptacle, then wipe the TV with a dry soft cloth. During thunder and lightning, unplug the power cord and antenna cord to prevent damage to your TV. All repairs to this TV should only be performed by qualified TV service personnel.

Main features

- ① Used as Television, display terminal, PC display;
- ② High luminance, wide viewing Angle;
- ③ HDMI interface and SCART Interface;
- ④ NICAM;
- ⑤ Time-shift;

Main parameter

Panel	26"	32"
TV System	PAL-B/G, I, D/K SECAM- B/G, D/K, L, L'	
Video Signal System	PAL/SECAM	
Input Power Voltage	AC 100V-240V 50/60Hz	
Power consumption	55W	90W
Audio Output Power (THD≤7%)	2x5W	2x8W
Signal Input	Analog RGB(PC)x1 High-Definition Multimedia Interface (HDMI) x 2 Video Input x1 Audio Input x2 USB Input x1 YPbPr x1 SCART x 1 COMMON IN INTERFACE(CI) PC audio x1	
Horizontal definition (TV line)	Composite Video input	≥350
	YPbPr	≥400

INSTALLATION

- *Locate the TV in the room where light does not strike the screen directly.
- *Total darkness or a reflection on the picture screen can cause eyestrain. Soft and indirect lighting is recommended for comfortable viewing.
- *Allow enough space between the TV and the wall to permit ventilation.
- *Avoid excessively warm locations to prevent possible damage to the cabinet or premature component failure.
- *Do not cover the ventilation openings when using the TV.

PC

PRESET MODE

	RESOLUTION	V.Freq.(Hz)	H.Freq.(KHz)
1	640x480	60	31.47
2	800x600	60	37.88
3	1024x768	60	48.36
4	1360x768	60	47.7
5	1280x1024	60	63.98
6	1920x1080	60	66.64

Base Stand Assembly Instruction

1. Insert the stand support pillar into the stand as the arrow indicated direction, and then fastened with three screws.

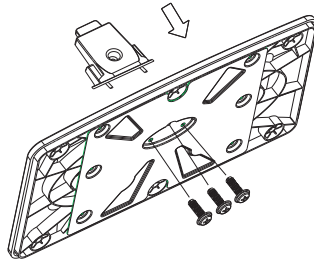

2. Insert the stand Ass'y into back cover as the arrow indicated direction, and then fastened with one screw.

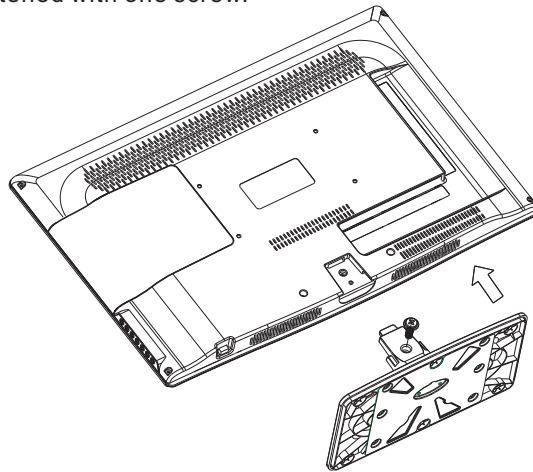

INSTALLATION NOTES

Locate the TV in a room where light does not strike the screen directly. Total darkness or a reflection on the screen can cause eyestrain. Soft and indirect lighting is recommended for comfortable viewing.

Allow enough space between the TV and the wall to permit ventilation.

Avoid excessively warm locations to prevent possible damage to the cabinet or premature component failure.

WALL MOUNTING INSTALLATION GUIDELINES

This television can be wall mounted as follows:

1. Place the LED LCD Television onto a solid surface. Please place some soft material over the front of the screen to protect it from any damage.
2. Remove the screws from the lower part of the television, where the base joins to the TV, and take away the stand (put the stand somewhere safe for future use).

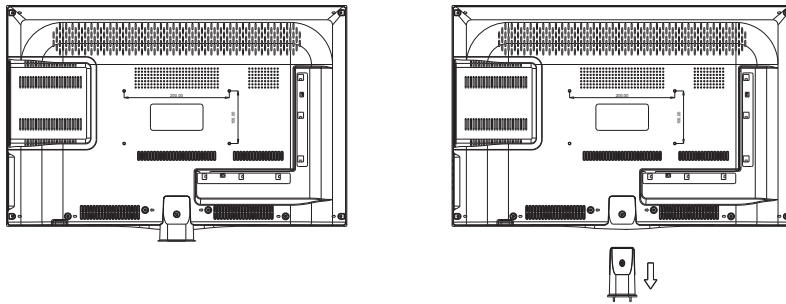

3. Use the four screws provided to fix the TV onto a wall mounting bracket (not included) via the four VESA standard holes on the back of the television.

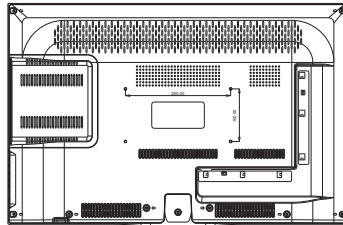

Front control panel

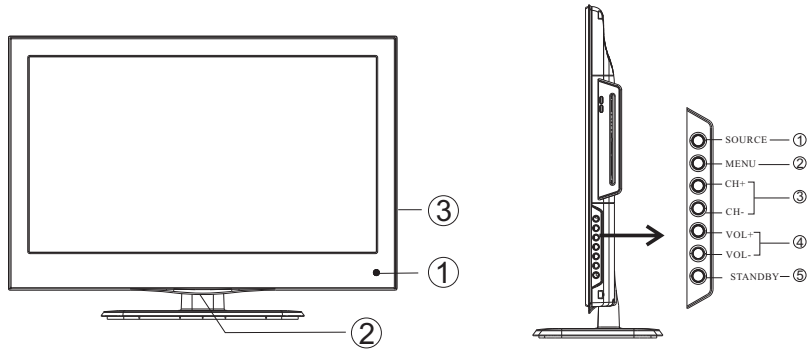

- | | |
|---|--|
| 1 | Remote control sensor. |
| 2 | Indicator LED:
BLUE: POWER ON. RED: STAND BY. |
| 3 | Key board. |

- | | | |
|---|------------------|--|
| 1 | SOURCE | Display the input source menu. |
| 2 | MENU | Display main MENU. |
| 3 | CH+/CH- | In TV mode, press CH+ or CH- to change the channel up and down.
In MENU, press CH+ or CH- to select items.
In standby mode, it can Turn on the TV. |
| 4 | VOL+/VOL- | Adjust sound level.
In MENU, adjust the item that you Selected. |
| 5 | STANDBY | |

Rear/Side Sockets

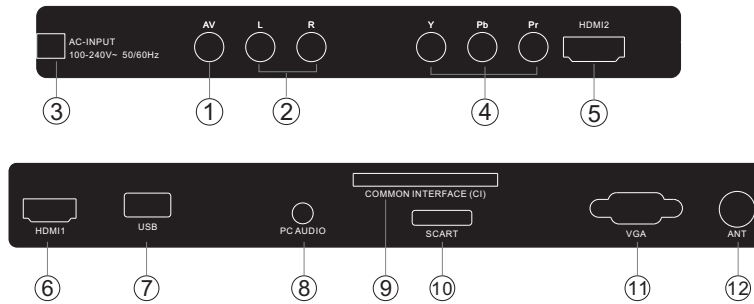

- | | | | | | |
|---|------------------------|-------|----|-----------------------------|--------|
| 1 | AV | input | 7 | USB | input |
| 2 | L/R AUDIO | input | 8 | PC AUDIO | input |
| 3 | AC Power Source | input | 9 | COMMON INTERFACE(CI) | Intput |
| 4 | YPbPr | input | 10 | SCART | Intput |
| 5 | HDMI2 | input | 11 | VGA INPUT | Input |
| 6 | HDMI1 | input | 12 | ANT | input |

Connecting to your Haier TV

Connecting a DVD player / Satellite / cable set top box receiver / games console / PC or Laptop

There are several options to connecting a DVD player / Satellite or Cable set top box receiver / games console / PC or Laptop to your TV.

Option 1 SCART

1 Connect a SCART cable (not supplied) from the SCART socket on the TV to the DVD player / Satellite or cable set top box receiver or games console.

2 To select the device connected with the SCART cable press the **SOURCE** button on the remote and use the **▼▲** keys to select **SCART** and press the **OK** button.

Note:- The TV will default to the SCART connection when the TV is switched on.

Option 2 HDMI

1 If the device you want to connect to the TV is switched on, switch off the device first.

2 Connect a HDMI cable (not supplied) from the HDMI socket on the TV to the DVD player / Satellite or cable receiver or games console.

3 Switch on the device you have just connected to the TV

4 To select the device connected with the HDMI cable press the **SOURCE** button on the remote and use the **▼▲** keys to select **HDMI** and press the **OK** button.

Option 3 AV Audio Visual

(Yellow/White/Red)

1 Make sure that both TV and the device are switched off before connecting.

2 Connect the AV cables (not supplied) from the Video (yellow) and Audio (white, red) sockets on the TV to the DVD player or games console etc.

3 To select the device connected with the AVI cable press the **SOURCE** button on the remote and use the **▼▲** keys to select **AV** and press the **OK** button.

Option 4 COMPONENT (Green/Blue/Red)+(White/Red)

1 Make sure that both TV and the device are switched off before connecting.

2 Connect the cables (not supplied) from the COMPONENT IN sockets Y, Pb, Pr (green, blue, red) and L-Audio-R (white, red) on the TV to the DVD player or games console etc.

3 To select the device connected with the AVI cable press the **SOURCE** button on the remote and use the **▼▲** keys to select **COMPONENT** and press the **OK** button.

Option 5 VGA (15pin Sub-D)

1 Connect a VGA cable (not supplied) from the VGA socket on the TV to the PC / Laptop.

2 To select the PC / Laptop connected with the VGA cable press the **SOURCE** button on the remote and use the **▼▲** keys to select **PC** and press the **OK** button.

Note VGA is video only. For audio from your PC/Laptop you need to connect a separate cable from the PC Audio (3.5mm jack) to the headphone socket on your PC/Laptop (3.5mm jack)

Option 6 USB

1 Most USB sticks can be connected to your TV and some digital cameras may also work.

2 Connect USB stick (not supplied) or a USB cable (not supplied) to the TV.

3 To select the USB device connected to the TV, press the **SOURCE** button on the remote and use the **▼▲** keys to select **USB** and press the **OK** button.

Note 1:- Only *.jpg and *.mp3 files will work, other file types are not guaranteed and may not.

Note 2. Apple iPhones and iPods are not compatible with you TV.

Note 3. When connecting any device to the USB connection, keep the USB cable length as short as possible.

COMMON INTERFACE

The common interface (CI) slot is designed to accept the conditional Access (CA) Module and Smart card in order to view the pay TV programmes and additional services. Contact your Common Interface service provider to get more information about the modules and subscription. Please note that CA modules and smart cards are neither supplied nor optional accessories from us.

Warning

- Switch off your TV before any module is inserted in the Common Interface slot.

- 1** Insert the CAM correctly, then Smart Card to the CI slot that is located at the side of the TV.

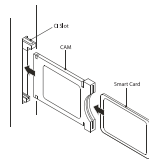

- 2** Turn on the TV and it will display the below message if the CA module is detected. Wait for few moments until the card is activated.

CI Module Inserted

- 3** Press the **MENU** button then press **▲ ▼** button to select CI Information option.

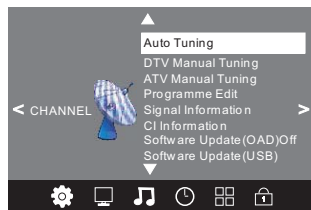

- 4** Detailed information on the CI card in use is displayed.
- 5** Press **OK** button to access the card menu. Refer to the module instruction manual for setting details.
- 6** When module is removed, the following message will appear on the screen.

CI Module Removed

03 Remote control

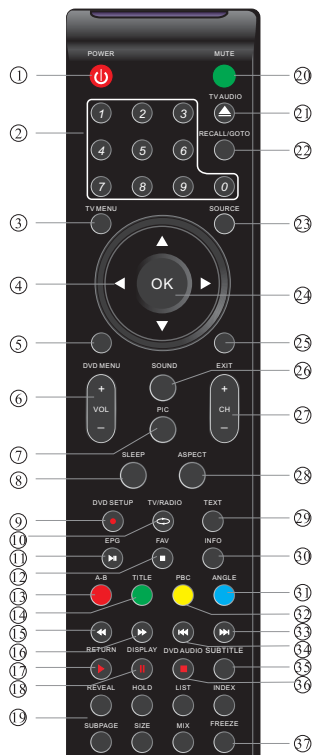

Insert Batteries Into the Remote Control

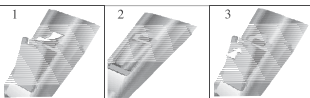

1. Remove the battery cover.
2. Inserting the 2 AAA 1.5V batteries making sure the polarity (+ or -) of the batteries matches the polarity marks inside the unit.
3. Mount the battery cover. Replace with new batteries when the TV set begins to show the following symptoms: Operation is unsteady or erratic. Sometimes the TV set does not function with Remote Control Unit.

Remark:

- 1) Alkaline Battery Recommended.
- 2) Remove batteries when they are exhausted or if the remote control is not to be used for Long time.

- 1: **POWER**: Press to turn the unit on or off.
- 2: **NUMERIC KEY**: Press for direct access to channels.
- 3: **TV MENU**: Press to display TV Main Menu.
- 4: **CURSOR**: Press to scroll through the Menu.
- 6: **VOL +/-**: Press to adjust the sound level.
- 7: **PIC**: Press to switch between picture modes.
- 8: **SLEEP**: Press to set Sleep Timer.
- 9: **REC**: Press to record the TV program you are watching in DTV Mode.
- 10: **TV/RADIO**: Press to switch between TV and Radio modes.
- 11: **EPG**: Press to display the 7 Day Electronic Program Guide For information on the show you are watching.
- 12: **FAV**: Press to access your favorite channels list in TV or DTV mode.
- 15: **REWIND**: Press to rewind play in USB Mode and Timeshift Mode.
- 16: **FAST FORWARD**: Press to Fast Forward play in USB mode or Timeshift Mode.
- 17: **PLAY**: Press the Play Button in USB Mode or Time Shift Mode to begin or continue Playback.
- 18: **PAUSE**: Press the Pause Button to start timeshift function or pause media play in DMP mode.
- 19: **TELETEXT KEYS**: Refer to page 12.
- 20: **MUTE**: Press to disable or enable the sound output.
- 21: **TV/AUDIO**: To select the available audio language of TV programs.
- 22: **RECALL/GOTO**: Press to return to the previously viewed channel.
- 23: **SOURCE**: Press to display the Input Source List.
- 24: **OK**: Press to confirm Menu selections.
- 25: **EXIT**: To exit the main menu, press the Exit Button or to cancel setting selections.
- 26: **SOUND**: Press to switch between the sound modes.
- 27: **CH+/CH-**: Press to scroll through your Channel List.
- 28: **ASPECT**: Press to change the picture aspect ratio.
- 29: **TEXT**: Press to enter or exit TELETEXT mode.
- 30: **INFO**: To display the program information of the show you are watching, press the Info Button.
- 33: **SKIP FORWARD**: Press to skip the next file or track in USB Mode.
- 34: **SKIP BACKWARD**: Press to skip the previous file or Track in USB Mode.
- 35: **SUBTITLE**: To turn on Subtitles press the Subtitle Button in DTV mode.
- 36: **■**: Press to stop playing in USB mode, or press to stop Time Shift.
- 37: **FREEZE**: Press to freeze the picture you are watching.



NOTE:

- 1) With no operation for 4 hours, the unit will go into the standby mode automatically.
- 2) For the DVD section, please refer to page 23.

REMOTE CONTROL

TELETEXT

Teletext is an information system broadcast by certain channels which can be consulted like a newspaper. It also offers access to subtitles for viewers with hearing problems or who are not familiar with the transmission language (cable networks, satellite channels, etc.)

Press:	You will obtain:
TEXT	This is used to call or exit teletext modes. The summary appears with a list of items that can be accessed. Each item has a corresponding 3 digit page number. If the channel selected does not broadcast teletext, the indication 100 will be displayed and the screen will remain blank (in this case, exit teletext and select another channel).
SELECTING A PAGE 	Enter the number of the page required using the 0 to 9 up/down. Example: page 120, enter 120. The number is displayed top left, the counter turns and then the page is displayed. Repeat this operation to view another page. If the counter continues to search, this means that the page is not transmitted. Select another number.
DIRECT ACCESS TO THE ITEMS 	Coloured are as are displayed at the bottom of the screen. The 4 coloured keys are used to access the items or corresponding pages. The coloured areas flash when the item or the page is not yet available.
INDEX	This returns to the contents page (usually page 100).
SUB PAGE	Certain pages contain sub-pages which are automatically displayed successively. This key is used to stop or resume sub-page acquisition. The indication appears top left.
HOLD	To freeze the page.
REVEAL	To display or hide the concealed information (games solutions).
LIST	The user can set four favorite pages to be directly linked to the four color keys. While list mode is activated, it is not possible to use TOP or FLOF navigation with the colorkeys. The favorite page numbers should be stored and restored to/from nonvolatile memory for each channel by the system software.

04 OPERATION

Installation Guide

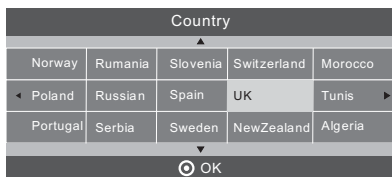
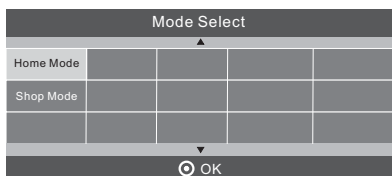
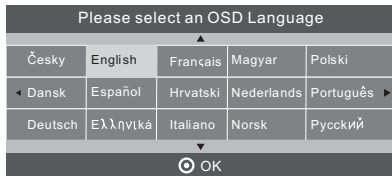

This screen only appears the first time the TV is turn on, or reset to factory set. You can choose language, energy-saving mode and country, auto turning programs. And after turning the screen will skip to the first DTV program.

1. CHANNEL MENU

The first item of the MENU is channel menu(for TV or DTV source only).

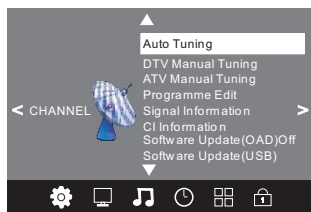

You can search channels and edit programs here.

1).Auto tuning:

Search all the channels automatically(you can select ATV and DTV)

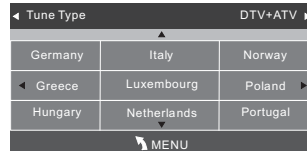

Please press ◀▶▲▼ to select country at first, then press OK button to start auto tuning.

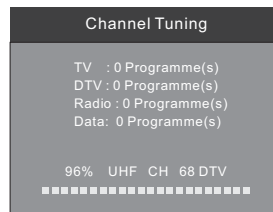

NOTE:

All the channels including ATV, DTV and Radio can be tuning by one time, if the Tune Type is DTV+ATV.

All the stored channels will be disappear after auto tuning.

After auto tuning, the channel will skip to the first DTV channel.

2).DTV Manual tuning:

You can select a DTV channel then find the program in this channel.

Pls press ◀▶ to select the channel, then press OK to search the programs.

NOTE:

Bad Normal Good means signal intensity.



3). ATV Manual tuning :

You can change the sound system to search the analog TV channels and fine tune the channels, then storage the channels you selected.



NOTE:

Press teletext red button to storage to channels after manual tuning .

4). Program edit:

You can Delete ,Rename ,Move, Skip , FAV any programs.

Delete

Press teletext red button , the program in cursor will delete.

Rename:

Only can rename ATV programs .
 Move the cursor to the program, press teletext green button to rename the program.
 Press ▼▲ to choose the character. Press ◀▶ to move the cursor .
 Press MENU button to exit edit , Press EXIT to exit the menu.
 Note: ATV programs name only can be 5 characters long, DTV programs name can be 25 characters long.

Move

Use the Arrow Buttons to select the channel you wish to move. Then press the Yellow Button to select Move function. Once active, enter the number button and then press OK to confirm.

Skip

Press ▼▲ to choose the program , press teletext blue button to skip this program, The Ⓞ will show on the right side of the program .
 Choose the skipped program, press blue button again , you can cancel the skip ,The Ⓞ will disappear .

Favourite

Press ▼▲ to choose the program , press FAV button , it will show ♥ on the right side of the program. Choose the FAV program , press FAV button again , you can cancel the FAV, ♥ the will disappear .

Once your favorite group is created, you can press the FAV key to quickly access your favorite channel.

5). CI information: (optional)

This menu can display the CI card's information.

2. PICTURE MENU

The second item of the MENU is PICTURE MENU.

You can adjust picture effect here, such as contrast, brightness, etc.

Press OK to move, press OK to adjust.

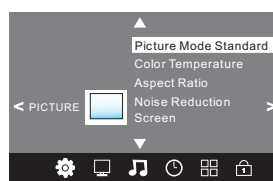

NOTE:

- 1).Tint is available in NTSC system only.
- 2).There are four colors temperature modes can be selected medium, warm, cool,user
- 3).Screen is available in PC mode only which, can adjust Horizontal position, vertical position, size and phase.

3.SOUND MENU

The third item of the MENU is the SOUND MENU.

You can adjust the sound effect here such as treble, bass, balance etc.

Press ▼▲ to move, press OK to adjust.

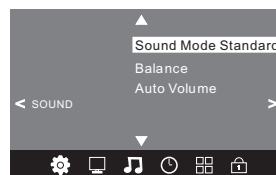

Note:

Auto volume: only available when the input signal volume is too large or distortion.

4.TIME MENU

The forth item of the menu is the TIME MENU

You can adjust the clock, power on/off time, sleep time etc Press ◀▶ to move, press OK to adjust



NOTE:
Within 15 minutes there is no signal, the TV will auto sleep, if Auto Sleep is set ON. The clock time can get from the DTV system auto.

5.OPTION MENU

The fifth item of the MENU is the OPTION MENU. You can adjust the Menu language, Audio language,Subtitle language etc.

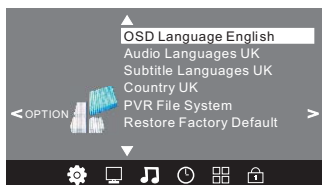

In PVR File system menu you can set up USB disk for PVR.

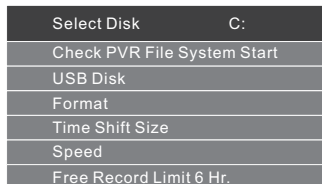

NOTE:
Restore factory default will clear all the programs and password.

6.LOCK MENU

The sixth item of the menu is the LOCK MENU. You can lock system, set password, block program and set parental guidance. Once you set the lock system on you can not search the channels or change any programs.

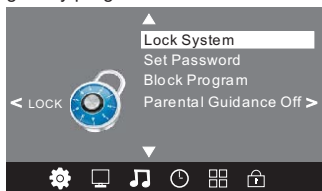

NOTE:
The default pass word is 0000, If you forget the password, you can use the super password:9443. Block program: Press ▼▲ to choose the program, press teletext green button to block the program. If you want unblock the program, pls enter the main menu, input the password, then press green button again. Parental guidance: Press ◀▶ to choose rating.

7.EPG Menu(Electronic Program Guide).

The EPG menu is used to look at what is being broadcasted on DTV or Radio channel in the day. To access the EPG menu, press the EPG button, the following menu will be displayed:

PROGRAMME GUIDE	TIME
28 Apr 04:39	
800 SZTVM01	No Information
801 SZTVM02	No Information
802 SZTVM03	No Information
803 SZTVM04	No Information
804 Date	No Information
Record	INFO
Schedule	Remind
OK	INDEX

1. **INFO**
Use ◀▶ to choose the programs, Press INFO key, you can display the highlight program's information.

2. **Schedule**
Press the teletext yellow key, It can list all the reminder schedule, press ▼▲ to choose the list, press red key DELETE to delete the schedule list, Press EPG to return to EPG menu.

Time	Date	Program me Title	Chann el Name

3. **Record**
Press the red key, It can set the program to be recorded.

4. **Remind**
Press the blue key to choose one program and set up one reminder time, the TV screen will skip to the choosed program in the reminder time automatically.

Reminder setting	
◀	802 SZTVM03 ▶
08 Minute	
05 Hour	
Apr Month	
28 Date	
★ Once Mode	
OK	BACK

8.PVR function

1.Prepare to record the program

From OPTION MENU enter into PVR File System In "OPTION MENU", please choose "check PVR File System". Click "OK", until "checking" change into "Success".

Note: please check the term "speed". If it is "HD support", that means the speed of USB device is available for time shift and record. If not, please format the device, to make sure the device available. The default "Free Record Limit" is 6 hour, if the space on the disk is big enough. If the space is not big enough, the record time should be shorter, depends on the room on the device. During the "check PVR File System" checking, please do not take any other operation until it finished.

The recordings have to be done with TV PVR system. It can only be played in the same TV, not in any other kind of devices (computer, DVD, etc...) which doesn't be compatible with .TS. Format.

See that in order to carry out any kind of recording, the TV will oblige you to format the connected device to store the recording.

WARNING. WHEN YOU FORMAT, THE EXTERNAL DEVICE WILL LOSE ALL THE FILES AND INFORMATION YOU STORAGE IN THE DEVICE.

From OPTION MENU enter into PVR File System as below:

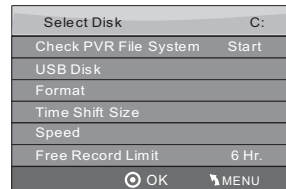

Select Disk:select which disc to save the record file.

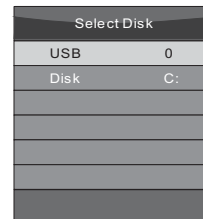

Check PVR File System: check if the PVR File System set up in the USB device or not.

Format:

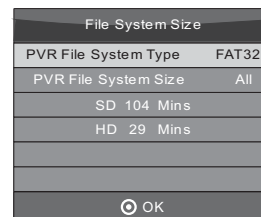
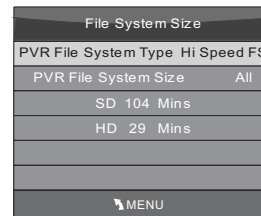

(Suggest to format the device by “High Speed Fs...” , which can speed up the record.)

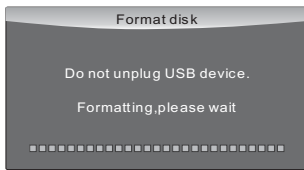
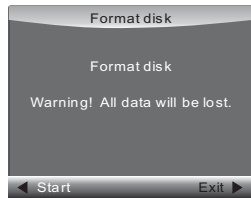

below menu appear after Format finish:

Select Disk	C:
Check PVR File System	Checking
USB Disk	Pass
Format	Pass
Time Shift Size	All
Speed	Checking
Free Record Limit	6 Hr.
MENU	

Select Disk	C:
Check PVR File System	SUCCESS
USB Disk	Pass
Format	Pass
Time Shift Size	All
Speed	HD support 2048 KB/s
Free Record Limit	6 Hr.
MENU	

If you select the “Hi Speed FS ” format mode, then you can change the time shift size:

Time Shift Size	
Time Shift Disk Size	512 MB
SB	14 Mins
HD	4 Mins

2.Record the program

As playing the DTV source, choose the channel and click “record” , the record frame will pop up. Click “record” again, the record frame will disappear and the “REC” icon still on the left top. It will disappear until you click “stop” .

3.Play the record

In “USB” , the record program will be saved in the folder “_MSTPVR” on the device.

1. The USB storage size needs to be the size between 4GB to 500GB.
2. Video may become pixelated when Video bit rate is too low.
3. Not all USB devices are compatible. Below is a list of recommended USB drives. Models that are not listed may be compatible, but it is not guaranteed to work.

The USB support list are the same as Timeshift function ,see the following pages for details.

9. Timeshift function

1. Prepare to record the program

This TV allows you to pause and record the currently watched digital program to a USB storage device, and to resume to the point where it was paused.

NOTE:

- Formatting a USB 2.0 storage device will be needed. Save your original data before formatting. All the data stored in the USB device will be erased after formatting.
- Sleep timer will be suspended if it had been set before activating the Time Shift function.

USB Drive Storage Format

Select to format the USB device and allocate the amount of space for the Time Shift function.

NOTE:

- The format process will take at least 2 minutes. Please do not turn off the power or remove the USB device during formatting.
- During formatting, a speed test will be done on the USB device. If it fails, it means the USB device may not support the Time Shift function.

Record a paused DTV program to USB storage device

1. While in the DTV input source, insert USB storage device to the USB port on the side of your TV.
2. Press PAUSE (18) to start Time Shift function. The TV program paused. The Time Shift OSD appears, and starts recording.
3. Press STOP (36) to stop Time Shift function and stop recording program.



NOTE:

- Please do not unplug the USB storage device when the Time Shift function is activated.
- Approximately 4GB of memory buffers about offer 140 minutes.

Time Shift limitations:

1. When the Time Shift feature is activated, only the PLAY/PAUSE/STOP/FWD/REV/VOL+/VOL-/MUTE keys and some basic operation keys (ENTER/EXIT/navigation keys) are available.

2. Video playback may not be smooth and skip if USB recording speed does not meet the minimum requirements .

3. Do Not remove USB disk or switch off the power during Time Shift operations. It will abort once the signal is lost.

4. Do Not remove the signal source during Time Shift operations.

5. Do Not quickly and repeatedly change operations between PLAY/PAUSE/FWD/REV.

6. Sleep timer will be terminated if it had been set before Time Shift.

7. Video may become pixelated when Video bit rate is too low.

8. Not all USB devices are compatible, The USB hard disk drive electricity should be < 500MA.
Below is a list of recommended USB drives. Models that are not listed may be compatible, but it is not guaranteed to work.

- SanDisk Extreme® Contour™ USB Flash Drive - 8GB SDCZ8-8192-E75
- SanDisk Extreme® Contour™ USB Flash Drive - 16GB SDCZ8-016G-A75
- Kingston DataTraveler 410 USB 2.0 Flash Drive - 8GB DT410/8GB
- Kingston DataTraveler 410 USB 2.0 Flash Drive - 16GB DT410/16GB
- OCZ Technology Rally2 USB 2.0 Flash Drive - 4GB OCZUSB2DC-4GB
- OCZ Technology ATV USB 2.0 Flash Drive - 8GB OCZUSBATV-8GB
- OCZ Technology Rally2 USB 2.0 Flash Drive - 8GB OCZUSB2DC-8GB
- SAMSUNG-HM500JI-500G

9. This feature is not available for all digital TV, such as scrambled or audio only channels.

10.USB Player

Press source key, and select USB in source list, press OK button to enter the USB menu.



Please make sure that the USB device have plugged in the slot. There are four type media item can be selected, such as photo, music, Movie, and text. Select the type media item by pressing ◀ ▶ , press **OK** button to enter the disk selection menu.

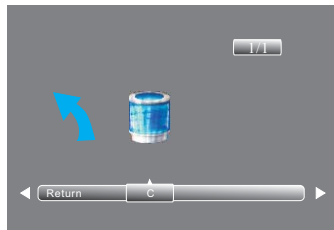

Press the ◀ ▶ to select the right disk and press **OK** to display media files and folder list or choose Return to back to the media type selection menu.

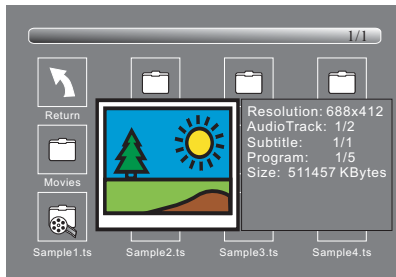

Select the media file by pressing ◀ ▶ or ▼ ▲ , then the preview frame will pop up. Press the button ▶ to play the media file in full screen. When the media file (photo, music, Movie, or text type) is playing, press the **OK** or Info button can display the control bar.



Press ◀ ▶ to select the function icon, press **OK** button to confirm the function.

Press ▼ or EXIT button to exit the control bar.

NOTE:

You can adjust the audio track, or program in the Info menu while Playing the video file. Choose the Info icon and press **OK** can display the Info MENU.

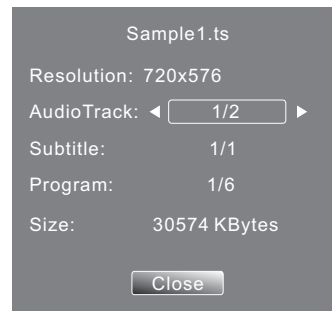

05 DVD OPERATION

DVD SIDE PANEL

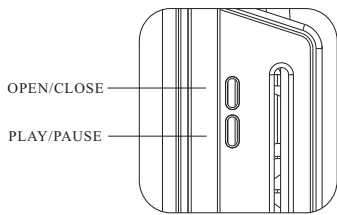

This DVD Player has a Class 1 laser which may be harmful to your eyes. Do not attempt to disassemble the cabinet or make And adjustments.
Refer all servicing to a qualified professional.

Features

Disc formats supported by this player:



MPEG4 files on discs



Multi-angle



Dolby Digital



Subtitle choices



KODAK picture CD



Audio choices



MP3 files on CD-R/CD-RW

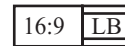

TV Aspect Ratio modes



DVD video



Parental Lock

This product incorporates copyright protection technology that is protected by method claims of certain U.S. patents and other intellectual property rights owned by Macro vision Corporation and other rights owners. Use of this copyright protection technology must be authorized by Macro vision Corporation, and is intended for home and other limited viewing uses only. Unless otherwise authorized by Macro vision Corporation. Reverse engineering or disassembly is prohibited.

The product complies with the KODAK Picture CD format and will display KODAK Picture CDs. The "KODAK Picture CD Compatible" logo is a trademark of Eastman Kodak Company and is used with permission.

Manufactured under license from Dolby Laboratories. "Dolby" and the double-D symbol are trademarks of Dolby Laboratories. Confidential Unpublished Works. 1992-1997 Dolby Laboratories, Inc. All rights reserved.

Remote Control - DVD section

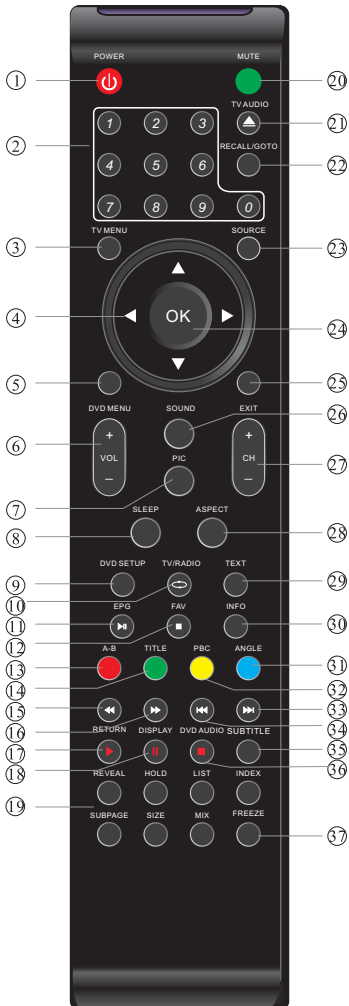

2:Numeric keys:Press to set the time, select title, chapter or track you wish to play. Press the ENTER/OK Button to confirm. When a VCD is playing (with PBC off), press the Numeric keys to select a track directly.

5: DVD MENU:During DVD playback, press MENU to display the disc menu.

9: DVD SETUP:Press to enter the system setting menu. Press again to exit the menu.

11: Play/Pause:Press to begin play of the DVD of media you wish to view. Press again to pause play.

12: STOP:Press to stop play of the DVD you are watching at anytime.

13: A-B:Press to repeat a segment of the disc you are watching between A and B. (DVD mode)

14: TITLE:Press to display the DVD Main Menu.

15: REV:Press to rewind play in DVD, CD MP3 or VCD mode. Press repeatedly to scroll through rewind speeds. Press the Play/Pause Button to resume play.

16: FWD:Press to fast-forward play in DVD, CD MP3 or VCD mode. Press repeatedly to scroll through fast-forward speeds. Press the Play/Pause Button to resume play

17: RETURN:Press to return to the Main Menu.

18: DISPLAY:Press to show the information of the current playing disc.

21: ▲ :To open the disc tray, press OPEN/CLOSE;To close the disc tray, press OPEN/CLOSE again.

22: GOTO:For DVD discs, press to choose the desired title and chapter and search the desired title, time and chapter time. For Super VCD, VCD, CD discs, press this button to search the desired disc time and track time and choose the desired track.

Note: During VCD playback, the PBC mode must be set to OFF.

24: OK:Press to confirm.

31: ANGLE:Press to view scenes shot from different angles. (Disc support is required)

32: PBC:During VCD/SVCD playback, press PBC to control PBC ON/OFF.

33: NEXT:During DVD, CD, MP3, or VCD playback, press NEXT to play the next chapter, title or track.

34: PREV:During DVD, CD, MP3, or VCD playback, press PREV to play the previous chapter, title or track.

35: SUBTITLE:Press to choose different captions (Requires support from disc).

37: FREEZE:Press to freeze the picture you are watching.

DVD OPERATION

MENU OPERATION

Press the **SETUP** button on the remote control, the **SETUP MENU** will be displayed. After accessing the setup menu, press the direction buttons for up and down movement to select an item desired, and press **RIGHT** direction button to select the lower item. Then press the **OK** button to confirm. Press **LEFT** direction button return to the menu of upper level. To exit the setup, press the **SETUP** button again. In the **SETUP MENU**, you may choose any of the following options as you like.

LANGUAGE SETUP

Select **Language** in the setup menu, and display the **Language** submenu:

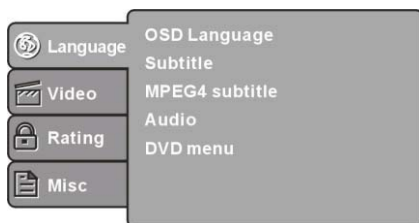

OSD Language

Use this item to select the language of the setup menu and screen display.

Subtitle

This option provides the preset subtitle language.

MPEG4 Subtitle(optional)

Select different MPEG4 subtitle encoding option.

Note: Not all players support this item.

Audio

Select the built-in disc dubbing language options.

DVD Menu

This option provides the film's menu language options.

VIDEO SETUP

Select **Video** in the setup menu, and display the **Video** submenu:

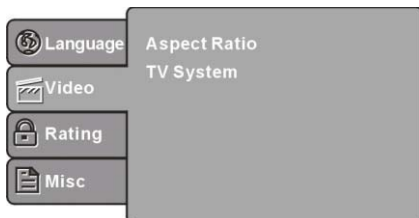

SYSTEM SETUP

Aspect Ratio

Select the aspect ratio.

Notes:

The image display ratio is related to the recorded disc format. Some disc can not display images in the aspect ratio you choose. If you play a disc recorded in 4:3 format on a wide screen TV, black bars will appear on the left and right side of the screen. You must adjust the screen setting depending on the type of the television you have.

TV System

Select the different TV system.

Note: The DVD player setting should be matched to your TV set. For more information of output format, refer to the instructions or your TV set.

RATING SETUP

Select **Rating** in the setup menu, and display the **Rating** submenu:

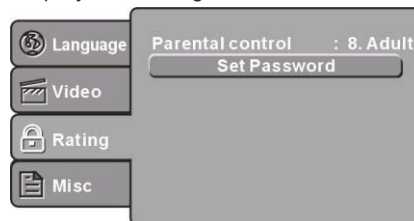

Parental Control

Set the parental control feature of the player

Note: Password is needed before setting *Parental Control*.

Set Password

Input four digits (password), then press **ENTER** to confirm.

Note: If you forget your password, please use the universal password 6666 to unlock.

MISC SETUP

Select **MISC** in the setup menu, and display the submenu:

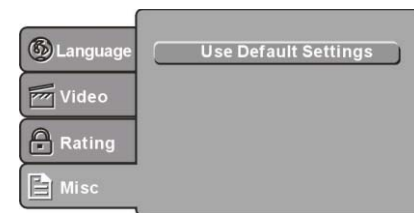

Use Default Settings

Reset setup data to factory default value.

DVD OPERATION

MP3/WMA/JPEG/MPEG4 PLAYBACK



The MP3/WMA/MPEG4 disc has such a directory structure as shown picture above. Press **Direction key** to choose the root directory and then press OK button to enter into the sub directory. Press **Direction key** to choose the desired track and then press **OK** or **PLAY** to enjoy the music or movie. If you want to return to the upper menu, press **Direction key** to choose  the icon and press **OK** button.

Filter: Allows selecting the categories of files displayed in the browser list.

Repeat: To switch different repeat playing mode

Mode: Select different playing mode as follows:

Normal: Shuffle mode is cancelled.

Shuffle: Shuffle mode enabled. When playback reaches the end of the current chapter/track, playback jumps to a random chapter/track. As the end of each chapter/track is reached, another random chapter/track will be played until all tracks/chapters have been played or the Shuffle mode is cancelled by toggling to a different **Mode** Option.

PICTURE CD PLAYBACK

The PICTURE CD disc has such a directory structure structure as shown in the following picture.



Press **Direction key** to choose the root directory and then press OK button to enter into the sub directory. Press **Direction key** to choose the desired picture and then press **OK** or **PLAY** to enjoy the picture. If you want to return to the upper menu, press **Direction key** to choose  the icon and press **OK** button.

Image rotation

In picture play state, press **Direction key** to rotate the picture.

Protect your DVD discs

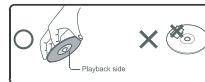

HANDLE DISCS PROPERLY

- ⊗ Do not touch the playback side of the disc.
- ⊗ Do not attach paper or tape to the disc.

HOW TO CLEAN A DISC

- ⊗ Fingerprints and dust on the disc cause picture and sound deterioration. Wipe the disc with a soft cloth from the centre outwards
- ⊗ If you cannot wipe off the dust with a soft cloth, wipe the disc lightly with a slightly moistened soft cloth and finish with a dry cloth.
- ⊗ Do not use any type of solvent such as thinner, benzene, commercially available cleaners or antiseptic spray for vinyl LPs. It may damage the disc.

06 DVD Trouble shooting

If you have any questions, please consult the troubleshooting guide below:

NO PICTURE OR SOUND

- Ensure the power button is on.
- Ensure the power outlet is operational.
- Ensure the power cord is not damaged.
- Ensure the power plug is connected firmly to the outlet.

PICTURE BUT NO SOUND

- Ensure the audio is not set to mute.
- Ensure you have set the player's AUDIO settings correctly.

POOR PICTURE OR SOUND

- Ensure you have set the player's AUDIO settings correctly
- Ensure the disc is not scratched or stained.

"BAD DISC" DISPLAYED

- Ensure the disc is not warped, damaged or deformed.
- Ensure the disc is not badly stained or damaged.
- Ensure the disc format is compatible with the player.
- Please check whether you have tried to play a software CD. If so, please restart the player.

REMOTE NOT WORKING

- Make sure the Main unit's POWER button is on
- Ensure the remote batteries are working.
- Point the remote control directly at the player's IR sensor.
- Remove any obstacles between the remote and the IR sensor.

















UNIT NOT WORKING

- Turn off the power, and then turn it on again.

"NO DISC" DISPLAYED

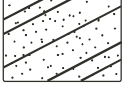
- Ensure you have put the disc on the tray.
- Ensure the disc is not upside down.
- Ensure the disc is not distorted, stained or scratched.

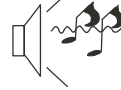
07 Trouble shooting

Trouble phenomenon Symptom		Inspection Check	
Picture	Audio		
 Snow	 Noise	antenna position, direction or connection	
 Ghost	 Normal audio	antenna position, direction or connection	
 Interference	 Noise	electronic equipment, car/ motorcycle, fluorescent light	
 Normal Picture	 Mute	Volume (check if mute is activated or if the audio system connections are not correct)	
 No picture	 Mute	Power cord is not inserted Power switch is not opened Contrast and brightness/volume setup Press standby key on the remote control for inspecting	
 No colour	 Normal audio	Colour control	
 Picture breaking up	 Normal audio or weak	retune channel	
 No colour	 Noise	TV system	
 There is black bar on top and bottom	 Normal audio	Change aspect to zoom	

07 Trouble shooting

Trouble Shooting Digital TV Problems and possible Solutions.

Picture Breaks into Pixels

A typical example of a reception problem includes the **break up of pictures** (pixilation) or the **picture freezing**, sometimes there are **clicking or squeaking** sounds or the **sound drops out** or there is **NO reception** at all.

Your picture may break into pixels due to the digital video signal dropping. The signal dropping may occur because of either problems with weak signals (see TV Aerials) or if you are connected by cable a weak cable signal. If the problem is weak signals, use an amplifier to strengthen the signal. A cable technician can help you install an inline amplifier or a pre-amplifier. This will boost your signal strength and fix the pixel problem.

If you are receiving your TV signal by satellite, check your dish has not moved following high winds, or that the signal is blocked by trees. Trees can be a problem as the TV signal can change depending if a tree between the satellite dish and satellite is in bare or in full leaf.

Missing channels

It may be that you find that there are **channels missing**, or you're receiving channels from the wrong region. Sometimes the **interactive services (red button) doesn't work**. This is usually caused by weak signal, see TV Aerials

TV Aerials

Digital terrestrial television (Freeview) comes to your TV via an aerial, The old aerial that was good for analogue TV may not work well for digital so may need upgrading. If you are getting some but not all of the digital channels on DTV (Freeview) for example you get BBC1, BBC2, Channel 4, but not ITV or Channel 5, this is usually because your aerial is a narrow band type, and needs to be changed to a wide band type.

Faulty Leads and Cables

Check your TV. Are the leads at the back - to the mains, the aerial, the set-top box, the video or DVD player or recorder properly connected? SCART leads are known to work loose over time and can result in both audio and video (picture) problems. Either left or right or both audio is missing and the colours are poor or muddy looking. Push the SCART plugs firmly in, this should fix the problem.

HDMI plugs need to be pushed in firmly; it's only the last millimetre that the contacts make. Typically the black plastic part of the HDMI plug should be very close or touching the body of the TV or component.

When plugging in any HDMI cables you may experience problems if the HDMI cables are plugged in when the TV or the other component is switched on. Always switch off both the TV and the component you are plugging in. If you have checked the plugs and sockets, switch off the TV and whatever you have plugged in to the TV and then switch them on again.

I have connected my PC to the TV. There is no sound.

If you connect your PC or Laptop to the TV using a VGA (15 pin Sub D) cable there is no audio, you need to connect a separate audio cable to the TV from the PC or laptop.

Unnatural Colours and Flesh Tones

Unnatural flesh tones and other colours could present another problem even in a new HDTV. This is due to the TV picture settings, which are optimized for a showroom environment. Fix this by changing the picture mode to natural in the picture menu. For more precision, try manually setting the colour, contrast and brightness options in the picture menu.

White Outlines

White outlines around objects and people generally appear either if the TV sharpness is set to very high, or if your television set uses some edge-enhancement processing technology. Go to the picture menu and adjust the sharpness till the white outline disappears. If edge-enhancement is enabled, try to disable it using the service menu.

Choppy Video

At times the video might become choppy. When this happens, check whether the signal is strong enough. If the signal is strong the problem is with the cable operator. If the signal strength is weak, try boosting the signal strength with the help of an amplifier.

The picture does not fill the screen

When connecting PC's or laptops to the TV, the picture may not fill the screen. Check the display settings on your PC or laptop (Windows > Start > Control Panel > Appearance and Personalization > Display settings) and select the best resolution. On your TV select:- TV Menu > Picture > Settings and then try AUTO, ZOOM1 or ZOOM2 for the best display.

USB Connection

The USB connection will work with *.jpg (photo) and *.mp3 (music) files. Please note the TV does not recognize Apple iPhone, or iPod's connected to the USB connector on the TV. The TV may play other files, but due to the multiple different file formats, there is no guarantee that these other file formats will work.

Specification

26" Full HD 1080P Digital LED LCD TV with DVD Player

Television picture quality:

Full HD
Integrated digital.
Screen Size: 66"cm
Resolution 1920 x 1080 pixels 50Hz.

Connectivity:

2 HDMI sockets.
1 SCART socket.
PC input socket.
Component video socket.
Composite.
1 USB port.

Sound quality:

NICAM stereo sound system.
2 x 8 watts RMS power output.

Digital features:

Digitally interactive.
Digital text.
Digital video broadcasting (DVB) subtitles available.
Auto setup.
Auto scan for new channels.
Now and next programme guide.
7 day electronic programme guide (EPG).
Top up TV compatible.
CI slot.
Audio description compatible.

Additional features:

UHF/VHF tuner.
Sleep timer.
Child lock.
Picture and text.
Remote control batteries required 2 x AAA (included).
VESA Mount Size 200 x 100 mm
Package Size (WxHxD): 730x520x130mm
Set Size (WxHxD) with Stand: 647x461x180mm
Set Size (WxHxD) without Stand: 647x420x40mm
Package weight : 7.8 kg
Set weight with stand: 6.5 kg
Set weight without stand: 5.94 kg

Specification

32" Full HD 1080P Digital LED LCD TV with DVD Player

Television picture quality:	Full HD Integrated digital. Screen Size: 81" cm Resolution 1920 x 1080 pixels 50Hz.
Connectivity:	2 HDMI sockets. 1 SCART socket. PC input socket. Component video socket. Composite. 1 USB port.
Sound quality:	NICAM stereo sound system. 2 x 8 watts RMS power output.
Digital features:	Digitally interactive. Digital text. Digital video broadcasting (DVB) subtitles available. Auto setup. Auto scan for new channels. Now and next programme guide. 7 day electronic programme guide (EPG). Top up TV compatible. CI slot. Audio description compatible.
Additional features:	UHF/VHF tuner. Sleep timer. Child lock. Picture and text. Remote control batteries required 2 x AAA (included). VESA Mount Size 200 x 100 mm Package Size (WxHxD): 864x590x125 mm Set Size (WxHxD) with Stand: 775x537x180mm Set Size (WxHxD) without Stand: 775x503x43mm Package weight : 10.77 kg Set weight with stand: 9.37 kg Set weight without stand: 8.81 kg

Haier