



ViewStation H.323

QuickStart



POLYCOM®

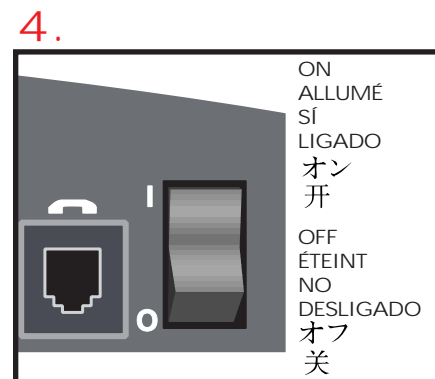
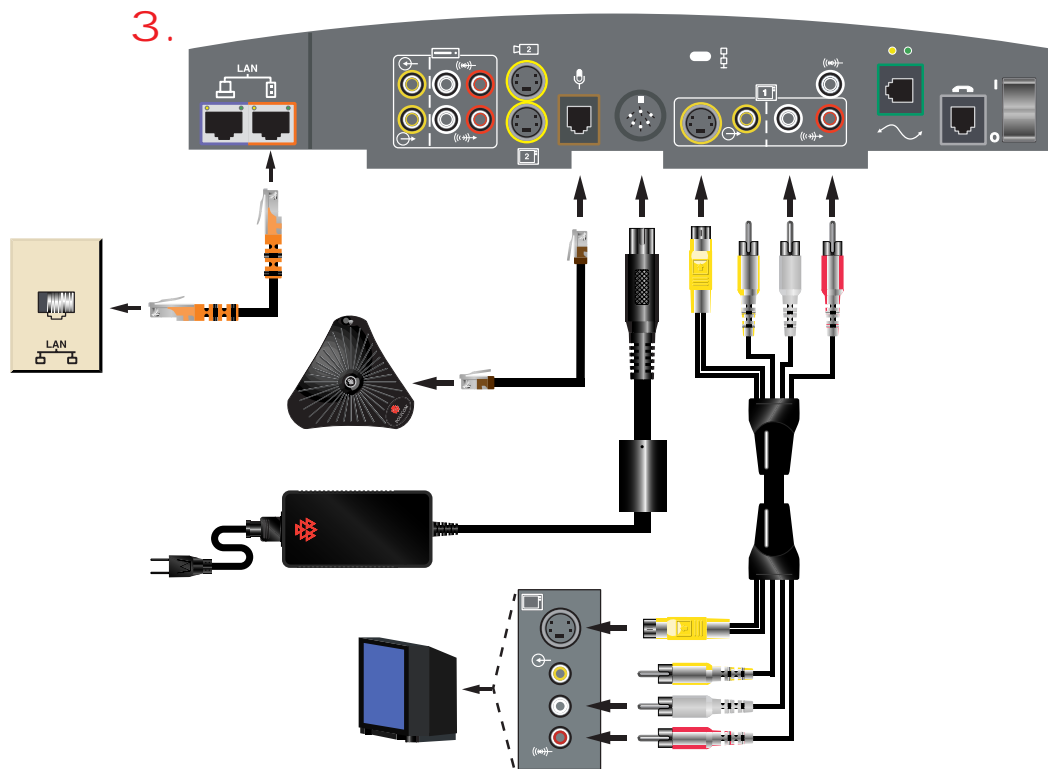
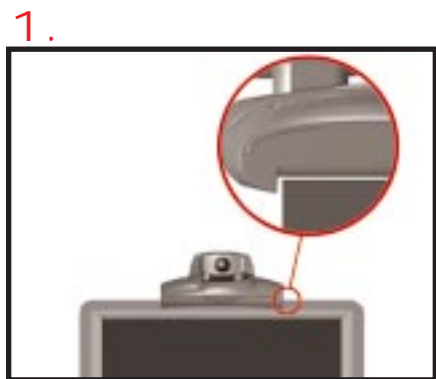

1.

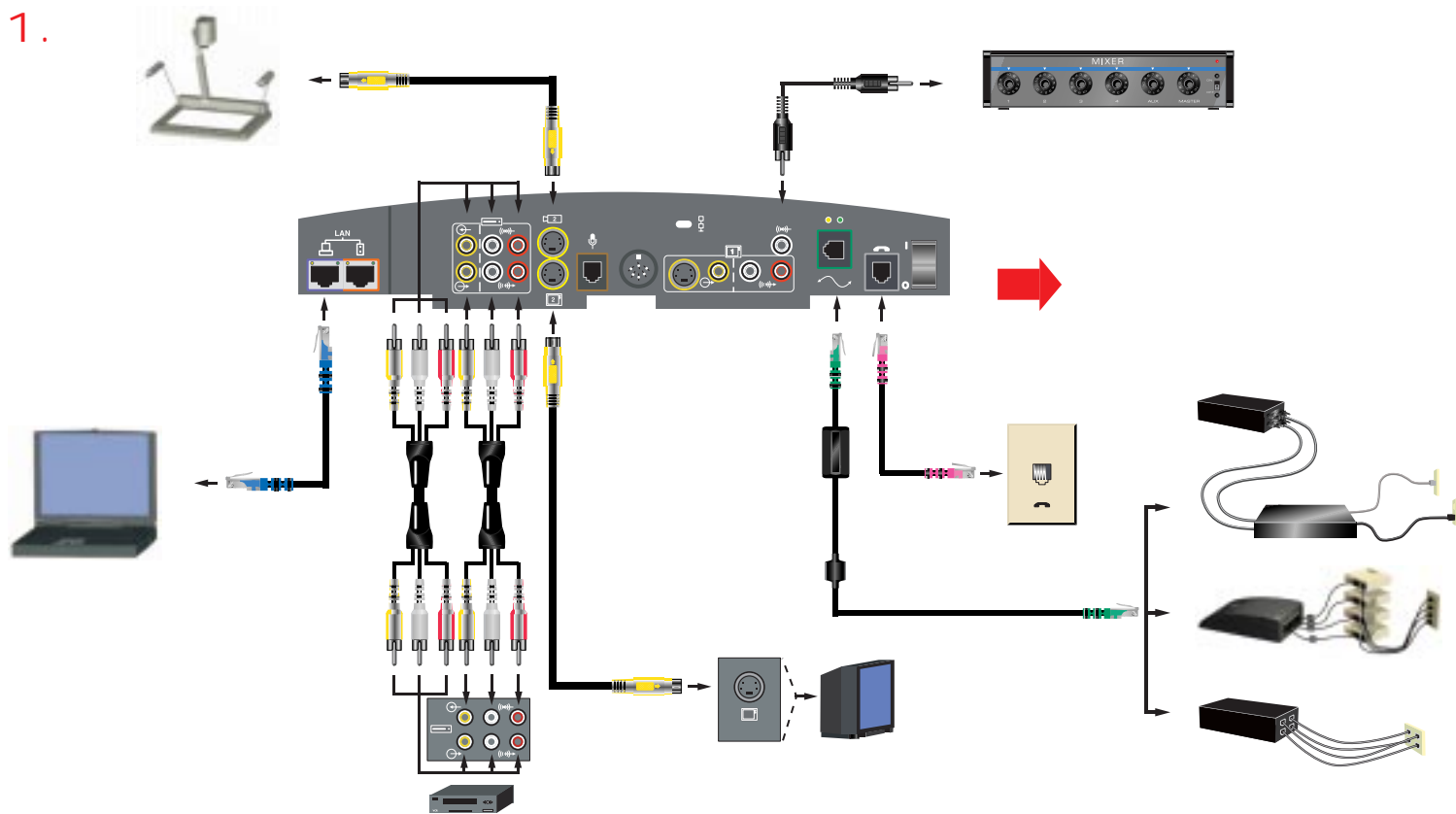

2.

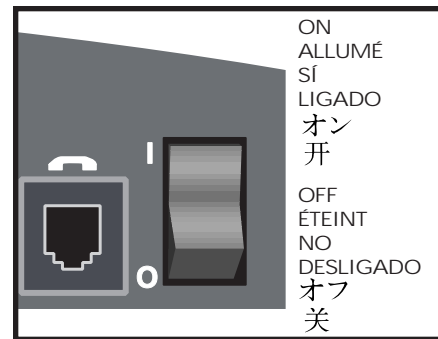

3.



VideoCall Appel vidéo composé manuellement/Llamada manual de video/Chamada de video/手動ビデオコール/ 视频拨叫



SpeedDial Appel à composition rapide/Selección rápida de llamada/Discagem rápida/スピードダイヤル/ 快速拨号

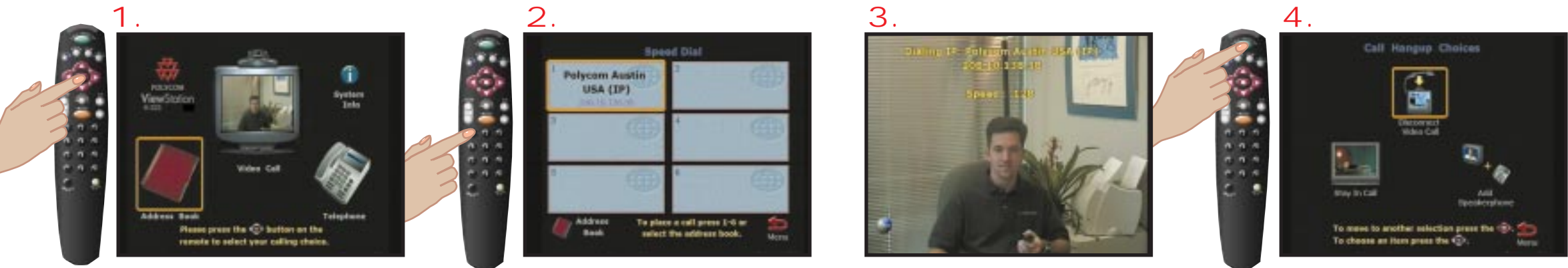

1. NearCamera/Caméra proche/Cámara cercana/
Cámara local/ニアカメラ/近程摄像机



2.

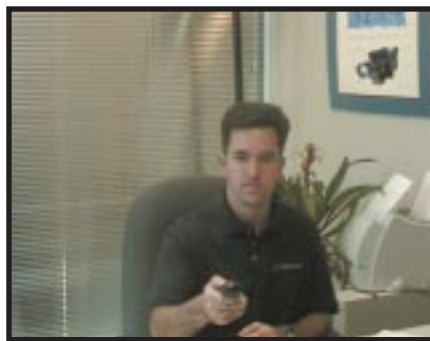

3.



1. FarCamera/Caméra lointaine/Cámara lejana/Cámara
a distancia/ファーカメラ/远程摄像机



2.

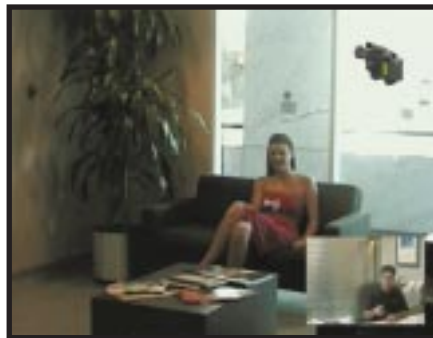

3.



4.

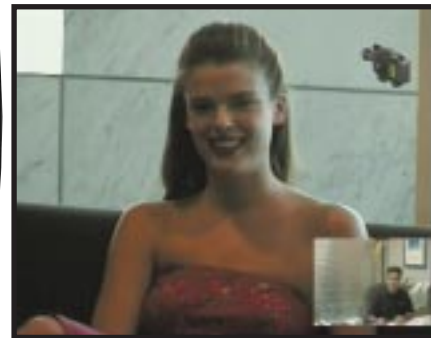

1. NearCamera/Caméra proche/Cámara cercana/
Câmera local/ニアカメラ/近程摄像机



2.



3.



1. FarCamera/Caméra lointaine/Cámara lejana/Cámara a
distância/ファーカメラ/远程摄像机

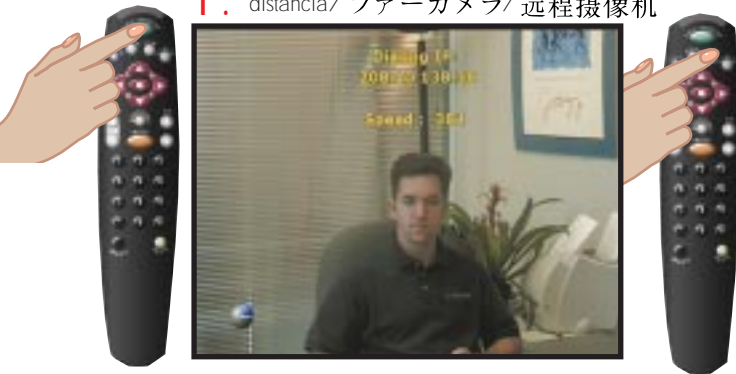

2.



3.

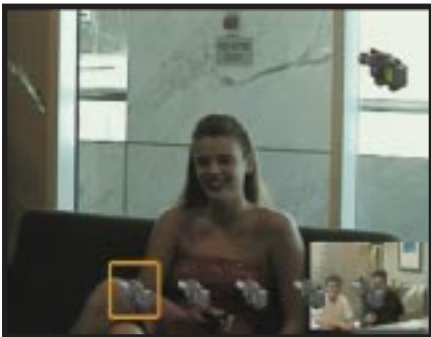

4.

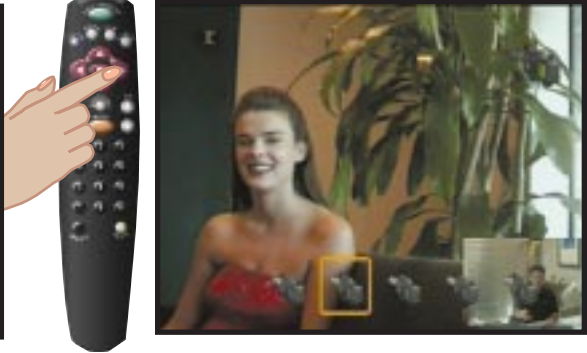



1.



2.



See your ViewStation User's Guide for descriptions of the following advanced features:

- Setting Camera Presets
- Organizing your Address Book
- Using your Document Camera and VCR
- Remotely Managing your ViewStation

Consulter le manuel de l'utilisateur de votre ViewStation pour les caractéristiques suivantes:

- Installation des pré-réglages de la caméra
- Organization de votre Carnet d'adresses
- Utilisation de votre caméra à documents et votre VCR
- Gestion à distance de votre ViewStation

Vea la guía al uso de la ViewStation para las descripciones de las siguientes características superiores:

- Instalación de valores preestablecidos de la Cámara
- Organización de vuestra libreta de direcciones
- Uso de la cámara de documentos y la videograbadora
- Gestión remota de la vuestra ViewStation

Consulte o seu Guia do Usuário do ViewStation para as descrições das seguintes características avançadas:

- Ajustamento predefinições da câmera
- Organizando o sua agenda
- Utilizando o seu Câmera do document e o VCR
- Gerenciando o seu ViewStation a Distância

次の高度機能の説明は『ViewStation User's Guide』を参照してください。

- カメラプリセットの設定
- アドレスブックの整理
- ドキュメントカメラとVCRの使い方
- ViewStationの遠隔管理

参照 ViewStation

用户指南中对下述高级特性的描述：

- 设置摄像机预设
- 整理号码簿
- 使用文档摄像机和VCR
- 从远方管理 ViewStation



POLYCOM®

Polycom, Inc., 1565 Barber Lane, Milpitas, CA 95035, U.S.A.

Telephone +1.408.526.9000 or toll-free +1.800.POLYCOM (in North America) Facsimile +1.408.526.9100 Internet www.polycom.com

Polycom®, and the Polycom logo design are registered trademarks and ViewStation™ is a trademark of Polycom, Inc. in the U.S. and various other countries.

© 2000 Polycom, Inc. All Rights Reserved. Part No. 1725-10423-001A

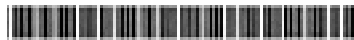

1725-10423-001A