

Register your product and get support at
www.philips.com/welcome

BDP3100



EN User manual

PHILIPS

Important notes for users in U.K.

Mains plug

This apparatus is fitted with an approved moulded plug. Should it become necessary to replace the main fuse, this must be replaced with a fuse of same value as indicated on the plug (example 10A).

1. Remove fuse cover and fuse.
2. The replacement fuse must comply with BS1362 and have the A.S.T.A. approval mark. If the fuse is lost, contact your dealer in order to verify the correct type.
3. Refit the fuse cover.

In order to maintain conformity to the EMC directive, the mains plug on this product must not be detached from the mains cord.

Copyright in the U.K.

Recording and playback of material may require consent. See Copyright Act 1956 and The Performer's Protection Acts 1958 to 1972.

Laser Specification:

- Laser Type:
 - BD Laser Diode: AlGaInN
 - DVD Laser Diode: AlGaInP
 - CD Laser Diode: AlGaInP
- Wave length:
 - BD: 405 +5nm/-5nm
 - DVD: 655 +10nm/-10nm
 - CD: 790 +10nm/-20nm
- Output power:
 - BD: Max. ratings: 20mW
 - DVD: Max. ratings: 6mW
 - CD: Max. ratings: 7mW

LASER

CAUTION:

USE OF CONTROLS OR ADJUSTMENTS OR PERFORMANCE OF PROCEDURES OTHER THAN THOSE SPECIFIED HEREIN MAY RESULT IN HAZARDOUS RADIATION EXPOSURE.

CAUTION:

VISIBLE AND INVISIBLE LASER RADIATION WHEN OPEN AND INTERLOCK DEFEATED. DO NOT STARE INTO BEAM.

LOCATION:

INSIDE, NEAR THE DECK MECHANISM.

Contents

1	Important	4
	Safety and important notice	4
	Trademark notice	4

2	Your product	5
	Feature highlights	5
	Playable media	6
	Product overview	6

3	Connect	7
	Connect video/audio cables	7
	Route audio to other devices	8
	Connect a USB device	9
	Connect network	9
	Connect power	9

4	Get started	9
	Prepare the remote control	9
	Find the TV input	10
	Use the Home menu	10
	Navigate the menu	10
	Select a menu display language	10
	Set up a network	10
	Use Philips EasyLink	11

5	Play	11
	Play a disc	11
	Play from a USB device	12
	Play video	12
	Play photo	14
	Play music	15

6	Adjust settings	16
	Video setup	16
	Audio setup	17
	Network setup	17
	EasyLink setup	18
	Preference setup	18
	Advanced setup	19

7	Additional Information	20
	Update software	20
	Care	20
	Specifications	21

8	Troubleshooting	21
----------	------------------------	----

9	Glossary	22
----------	-----------------	----

1 Important

Safety and important notice



Warning

- Risk of overheating! Never install the product in a confined space. Always leave a space of at least 4 inches around the product for ventilation. Ensure curtains or other objects never cover the ventilation slots on the product.
- Never place the product, remote control or batteries near naked flames or other heat sources, including direct sunlight.
- Only use this product indoors. Keep this product away from water, moisture and liquid-filled objects.
- Never place this product on other electrical equipment.
- Keep away from this product during lightning storms.
- Where the mains plug or an appliance coupler is used as the disconnect device, the disconnect device shall remain readily operable.
- Visible and invisible laser radiation when open. Avoid exposure to beam.



This product complies with the radio interference requirements of the European Community.



Disposal of your old product and batteries

Your product is designed and manufactured with high quality materials and components, which can be recycled and reused.

When this crossed-out wheeled bin symbol is attached to a product it means that the product is covered by the European



Directive 2002/96/EC. Please inform yourself about the local separate collection system for electrical and electronic products.

Please act according to your local rules and do not dispose of your old products with your normal household waste.

Correct disposal of your old product helps to prevent potential negative consequences for the environment and human health.

Your product contains batteries covered by the European Directive 2006/66/EC, which cannot be disposed with normal household waste.



Please inform yourself about the local rules on separate collection of batteries because correct disposal helps to prevent negative consequences for the environmental and human health.

Copyright notice



Be responsible Respect copyrights

This item incorporates copy protection technology that is protected by U.S. patents and other intellectual property rights of Rovi Corporation. Reverse engineering and disassembly are prohibited.

Open source software

Philips Electronics Hong Kong Ltd. hereby offers to deliver; upon request, a copy of the complete corresponding source code for the copyrighted open source software packages used in this product for which such offer is requested by the respective licenses.

This offer is valid up to three years after product purchase to anyone in receipt of this information.

To obtain source code, please contact open.source@philips.com. If you prefer not to use email or if you do not receive confirmation receipt within a week after mailing to this email address, please write to "Open Source Team, Philips Intellectual Property & Standards, P.O. Box 220, 5600 AE Eindhoven, The Netherlands." If you do not receive timely confirmation of your letter, please email to the email address above.

Trademark notice



'Blu-ray Disc' and 'Blu-ray Disc' logo are trademarks.



HDMI, and HDMI logo and High-Definition Multimedia Interface are trademarks or registered trademarks of HDMI licensing LLC.



Manufactured under license from Dolby Laboratories. Dolby and the double-D symbol are trademarks of Dolby Laboratories.



Master Audio Manufactured under license under U.S. Patent #'s: 5,451,942; 5,956,674; 5,974,380; 5,978,762; 6,226,616; 6,487,535; 7,392,195; 7,272,567; 7,333,929; 7,212,872 & other U.S. and worldwide patents issued & pending. DTS is a registered trademark and the DTS logos, Symbol, DTS-HD and HTS-HD Master Audio are trademarks of DTS, Inc. © 1996-2008 DTS, Inc. All Rights Reserved.



ABOUT DIVX VIDEO: DivX® is a digital video format created by DivX, Inc. This is an official DivX Certified device that plays DivX video. Visit www.divx.com for more information and software tools to convert your files into DivX video.

ABOUT DIVX VIDEO-ON-DEMAND: This DivX Certified® device must be registered in order to play DivX Video-on-Demand (VOD) content. To generate the registration code, locate the DivX VOD section in the device setup menu. Go to vod.divx.com with this code to complete the registration process and learn more about DivX VOD. DivX® and DivX Ultra® are registered trademarks of DivX, Inc., and are used under license.



BONUSVIEW™

'BD LIVE' and 'BONUSVIEW' are trademarks of Blu-ray Disc Association.



'AVCHD' and 'AVCHD' logo are trademarks of Matsushita Electric Industrial Co., Ltd and Sony Corporation.



'x.v.Colour' is a trademark of Sony Corporation.



The USB-IF Logos are trademarks of Universal Serial Bus Implementers Forum, Inc.



'DVD Video' is a trademark of DVD Format/Logo Licensing Corporation.



Java and all other Java trademarks and logos are trademarks or registered trademarks of Sun Microsystems, Inc. in the United States and/or other countries.



Windows Media and the Windows logo are trademarks, or registered trademarks of Microsoft Corporation in the United States and/or other countries.

2 Your product

Congratulations on your purchase, and welcome to Philips! To fully benefit from the support that Philips offers (e.g. product software upgrade), register your product at www.philips.com/welcome.

If you contact Philips, you will be asked for the model and serial number of your product. The model number and serial number are on the back of your product. Write the numbers here:

Model No. _____

Serial No. _____

Feature highlights

For optimal performance of this product, it is suggested to regularly update the software of this product.

High-Definition entertainment

Watch high-definition content disc with HDTV (High Definition Television). Connect it through a high speed HDMI cable (1.3 or category 2). You can enjoy excellent picture quality up to 1080p resolution with the frame rate of 24 frames per second with progressive scan output.

BD-Live

Connect this player to the movie studios website via the LAN port to access a variety of up-to-date content (e.g. refreshed previews and exclusive special features).

Playable media

This product can play:

- BD-Video, BD-R/RE2.0
- DVD, DVD-Video, DVD+R/+RW, DVD-R/-RW, DVD+R/-R DL (Dual Layer)
- Video CD/SVCD
- Audio CD, CD-R/CD-RW, MP3 media, WMA media, JPEG files
- DivX (Ultra) media
- USB flash drive

Region codes

You can play discs with the following region codes.

Region code	Countries
DVD	Europe, United Kingdom
Blu-ray	



Product overview

Main unit

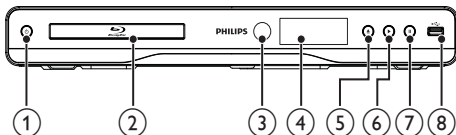





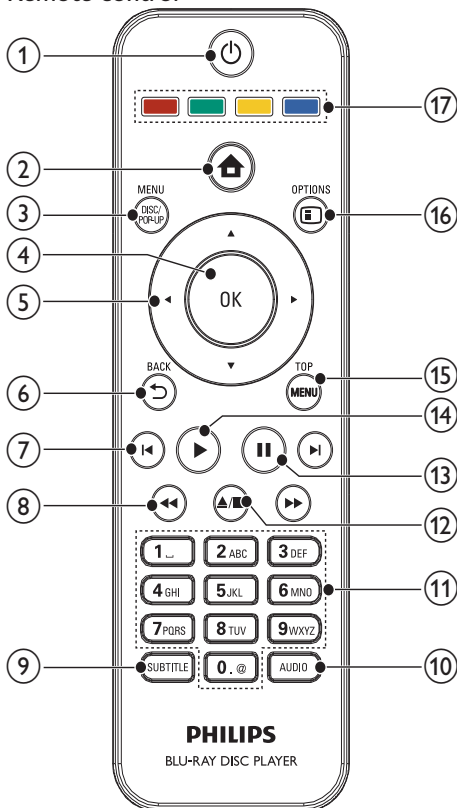

- Turn on this product or switch to standby mode.
- Disc compartment**
- IR sensor**
 - Detect signals from the remote control. Always point the remote control at the IR sensor.
- Display panel**
- Open or close the disc compartment.
- Start or resume play.
- Pause play.
- jack**
 - Connect a USB flash drive.

Remote control



- Turn on this product or switch to standby mode.
 - When EasyLink is enabled, press and hold for at least three seconds to turn all connected HDMI CEC compliant devices to standby.
- Access the home menu of this product.
- DISC MENU / POP-UP MENU**
 - **BD**: Access or exit the pop-up menu.
 - **DVD**: Access or exit the disc menu.
- OK**
 - Confirm an entry or selection.
- Navigate through the menus.
- BACK**
 - Return to a previous display menu.

- 7  • Skip to the previous or next title, chapter, or track.
- 8  • Search backward or forward.
- 9 **SUBTITLE**
• Select a subtitle language on a disc.
- 10 **AUDIO**
• Select an audio language or channel on a disc.
- 11 **Alphanumeric buttons**
• Select an item to play.
• Enter values.
- 12  • Stop play.
• Press and hold to open/close the disc compartment.
- 13  • Pause play.
• Move the paused picture one step forward.
- 14  • Start or resume play.
- 15 **TOP MENU**
• **BD**: Display the top menu.
• **DVD**: Display the title menu.
- 16  **OPTIONS**
• Access options for the current activity or selection.
- 17 **Color buttons**
• **BD**: Select tasks or options.

3 Connect

Make the following connections to use this product.

Basic connections:

- Video
- Audio
- Power

Optional connections:

- Route audio to other devices
 - HDMI-compliant AV receiver/amplifier
 - Digital AV amplifier/receiver
 - Analog stereo system
- USB flash drive
- LAN (network)

Note

- Refer to the type plate at the back or bottom of the product for identification and supply ratings.
- Before you make or change any connections, ensure that all the devices are disconnected from the power outlet.

Connect video/audio cables

Select the best video connection that the TV can support.

- **Option 1:** Connect to the HDMI jack (for a HDMI, DVI or HDCP-compliant TV).
- **Option 2:** Connect to the component video jacks (for a standard TV or Progressive Scan TV).
- **Option 3:** Connect to the composite video jack (for a standard TV).

Option 1: Connect to the HDMI jack

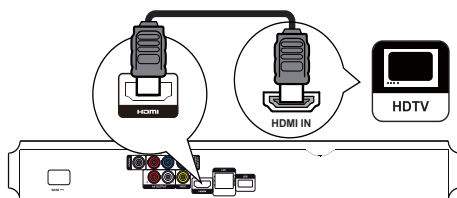

- 1 Connect an HDMI cable (not supplied) to:
 - the **HDMI** jack on this product.
 - the HDMI input jack on the TV.

Tip

- If the TV has a DVI connector only, connect via an HDMI/DVI adaptor. Connect an audio cable for sound output.
- If there is a blank screen under HDMI connection, on the remote control press  and then press "731" (numeric buttons) to recover picture display.
- If this product connects to a TV compatible with 1080p or 1080p/24Hz, Philips recommends HDMI category 2 cable, also known as High Speed HDMI cable, for optimal video and audio output.
- To play the digital video images of a BD-video or DVD-video via an HDMI connection, it is necessary that both this product and the display device (or an AV receiver/amplifier) support a copyright protection system called HDCP (high-bandwidth digital content protection system).
- This connection provides best picture quality.

Option 2: Connect to the component video jack

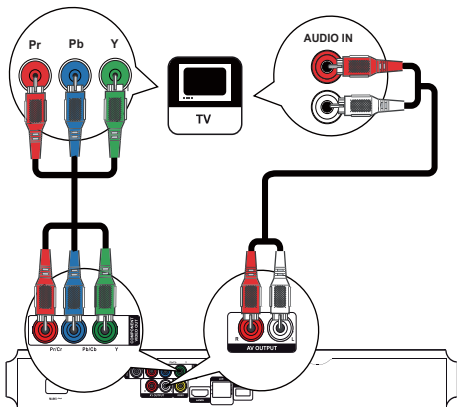

- 1 Connect the component video cables (not supplied) to:
 - the **Y Pb/Cb Pr/Cr** jacks on this product.
 - the **COMPONENT VIDEO** input jacks on the TV.
- 2 Connect the audio cables to:
 - the **AV OUTPUT-L/R** jacks on this product.
 - the **AUDIO** input jacks on the TV.

Tip

- The component video input jack on the TV might be labeled as **Y Pb Pr** or **YUV**.

Option 3: Connect to the composite video jack

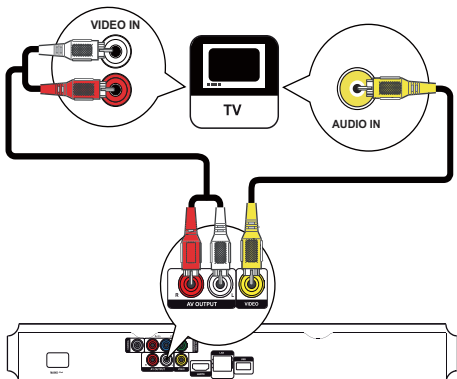

- 1 Connect a composite video cable to:
 - the **VIDEO** jack on this product.
 - the **VIDEO** input jack on the TV.
- 2 Connect the audio cables to:
 - the **AV OUTPUT-L/R** jacks on this product.
 - the **AUDIO** input jacks on the TV.

Tip

- The video input jack on the TV might be labeled as **A/V IN**, **VIDEO IN**, **COMPOSITE** or **BASEBAND**.

Route audio to other devices

You can route the audio from this product to other devices.

Connect to an HDMI-compliant AV receiver/amplifier

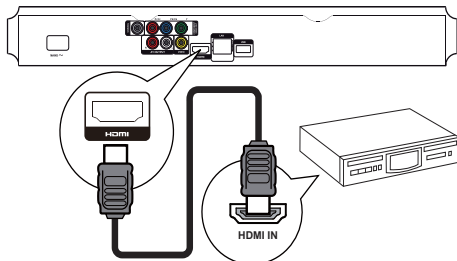

- 1 Connect an HDMI cable (not supplied) to:
 - the **HDMI** jack on this product.
 - the **HDMI** jack input jack on the device.

Tip

- The HDMI connection provides best audio quality.

Connect to a digital AV amplifier/receiver

Connect to a coaxial jack

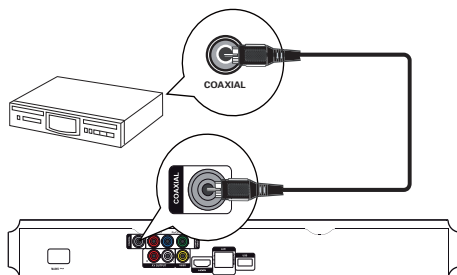

- 1 Connect a coaxial cable (not supplied) to:
 - the **COAXIAL** jack on this product.
 - the **COAXIAL/DIGITAL** input jack on the device.

Connect an analogue stereo system

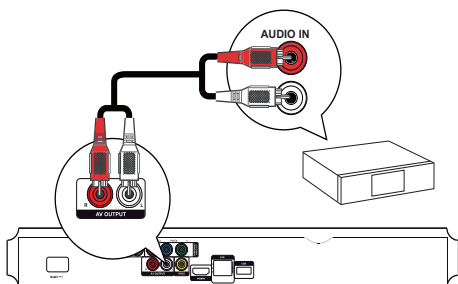



- 1 Connect the audio cables to:
 - the **AV OUTPUT-L/R** on this product.
 - the **AUDIO** input jacks on the device.

Connect a USB device

A USB device provides an additional memory to enjoy software updates and BD-Live.

- 1 Connect a USB device to the  (**USB**) jack on this product.
 - The USB jack on the rear panel is not for media files play, only for software upgrade/BD Live via USB.

Note

- Press , and select **[browse USB]** in the menu to access the content and play the files.
- Connect a USB device only to the  jack of this product.
- Philips does not guarantee compatibility with all USB devices.

Connect network

Connect this product to the network to enjoy software updates and BD-Live.

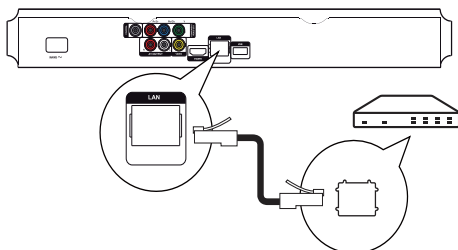

- 1 Connect a network cable (not supplied) to:
 - the **LAN** jack on this product.
 - the **LAN** jack on the broadband modem or router.

Note

- Internet access to Philips website for software update may not be allowed, depending on the router you use or the Internet Service Provider's policy. Contact your Internet Service Provider for more information.

Connect power

Caution

- Risk of product damage! Ensure that the power supply voltage corresponds to the voltage printed on the back of the unit.
- Before connecting the AC power cord, ensure you have completed all other connections.

Note

- The type plate is located on the back of the product.

- 1 Connect the AC power cable to:
 - this product.
 - the wall socket.

➔ This product is ready to be set up for use.

4 Get started

Caution

- Use of controls or adjustments or performance of procedures other than herein may result in hazardous radiation exposure or other unsafe operation.

Always follow the instructions in this chapter in sequence.

Prepare the remote control

- 1 Press and push the battery compartment to slide it open (see "1" in the illustration).
- 2 Insert two AAA batteries with correct polarity (+/-) as indicated.
- 3 Push and slide back the battery compartment (see "3" in the illustration).

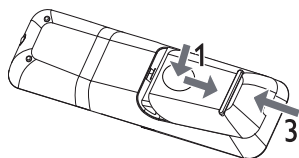

Note

- If you are not going to use the remote control for a long time, remove the batteries.
- Do not mix batteries (old and new or carbon and alkaline, etc.).
- Batteries contain chemical substances, so they should be disposed of properly.

Find the TV input

- 1 Press **⏻** to turn on this product.
- 2 Turn on the TV and switch to the video input (refer to the TV user manual on how to select the A/V input).

Use the Home menu



- 1 Press **⬆** to display the home menu.
 - To start disc play, select **[play Disc]**.
 - To view the USB contents, select **[browse USB]**.
 - To access the setup menus, select **[Setup]**.

Navigate the menu

- 1 When a menu is displayed, press the buttons on the remote control to navigate.

Button	Action
▲▼	Move up or down.
◀▶	Move left or right.
OK	Confirm a selection.
1., 2.00, 3.00, 4.00, 5.00, 6.00, 7.00, 8.00, 9.00, 0., .	Enter numbers.

Select a menu display language

Note

- If this product is connected to a HDMI CEC compliant TV, skip this setting. It switches automatically to the same OSD menu language as per your TV setting (if the language set on TV is supported by this product).

- 1 In the Home menu, select **[Setup]** and press **OK**.
- 2 Select **[Preference Setup]**, and press **▶**.
- 3 Select **[Menu Language]**, and press **▶**.

Video Setup	Menu Language	Auto (ENG)
Audio Setup	Audio	English
Network Setup	Subtitle	Français
EasyLink Setup	Disc Menu	Deutsch
Preference Setup	Parental Control	Italiano
Advanced Setup	Screen Saver	Español
	Auto Subtitle Shift	Nederlands
	Change Password	Svenska

- The language options may vary from different regions.
- 4 Press **▲▼** to select a language, and press **OK**.

Set up a network

To enjoy software updates of this product and BD-Live for certain Blu-ray discs, set up the network connection.

Note

- Ensure that the network cable is properly connected and the router is switched on.

- 1 Connect this product to the broadband modem or router.
- 2 Press **⬆** to display the home menu.
- 3 Select **[Setup]** and press **OK**.

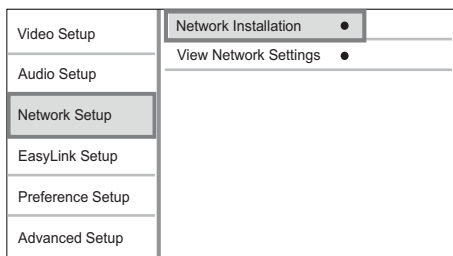

- 4 Select **[Network Setup]**, and press **▶**.
- 5 Select **[Network Installation]**, and press **OK**.
- 6 Follow the on-screen instructions to complete the network installation.



Tip

- You can check the status of the wired connection of this product (see "Adjust settings" > "Network Setup" > **[View Network Settings]** or **[View Wireless Settings]**).



Note

- Loading BD-Live content from the internet may take some time, depending on the file size and the speed of the internet connection.

Use Philips EasyLink

This product supports Philips EasyLink which uses the HDMI CEC (Consumer Electronics Control) protocol. You can use one single remote control to control EasyLink-compliant devices that are connected through HDMI connectors.



Note

- To enable the EasyLink feature, you must turn on the HDMI CEC operations on the TV and on other devices connected to TV. Refer to the TVs/devices manual for details.

One-touch play

- 1 Press **⏻** (standby) to turn on this product.
 - ↳ The TV (if the TV supports one-touch play) automatically turns on and switches to the correct video-in channel.
 - ↳ If a disc is loaded in this product, disc play automatically starts.

One-touch standby

- 1 Press and hold **⏻** (standby) for more than 3 seconds.
 - ↳ All the connected devices (if the device supports one-touch standby) automatically switch to standby.



Note

- Philips does not guarantee interoperability with other HDMI CEC devices.

5 Play

Play a disc



Caution

- Do not place any objects other than discs into the disc compartment.

- 1 Press **▶** on the front panel to open the disc compartment.
 - You may also press and hold **■** on the remote control to open/close the disc compartment.
- 2 Insert a disc with its label facing up.
- 3 Press **▶** to close the disc compartment and start disc play.
 - To view disc play, turn on the TV to the video input.
 - To stop disc play, press **■**.



Note



- Check disc/file formats supported (see "Your product" > "Playable media").
- If the password entry menu is displayed, enter the password before you can play the locked or restricted disc (see "Adjust settings" > "Preference Setup" > **[Parental Control]**).
- If you pause or stop a disc, the screen saver appears after 10 minutes of inactivity. To deactivate the screen saver, press any button.
- After you pause or stop a disc and no button is pressed within 30 minutes, this product automatically switches to standby.

Play from a USB device

Play or view media files on the following USB devices:

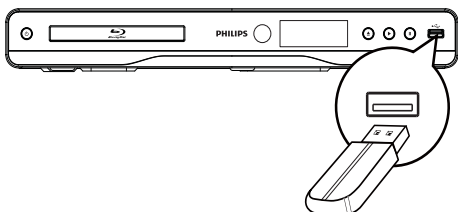
- flash drive
- memory card reader
- HDD (This product can detect only a portable hard disc drive with USB power peak current no more than 500mA.)



- 1 Connect a USB device to the  (USB) jack of this product.
- 2 Press  and select **[browse USB]**, and press **OK**.
↳ A contents menu is displayed.
- 3 Select a file to play, and press **OK**.
↳ Play starts (see "Play video", "Play photo", "Play music" for details).
 - To stop play, press  or remove the USB device.









Note

- Philips does not guarantee compatibility with all USB devices.
- Not all digital cameras are supported. Digital cameras that require PC programme installation are not supported.
- NTFS (New Technology File System) data format is not supported.

Play video

Control video play

- 1 Play a title.
- 2 Use the remote control to control the play.

Button	Action
	Pause play. <ul style="list-style-type: none"> • Press repeatedly  to slow forward play frame by frame.
	Start or resume play.
	Stop play.
	Skip to a previous/next title or chapter.
	Search fast-backward or fast-forward. Press repeatedly to change the search speed. <ul style="list-style-type: none"> • Press once , and then press repeatedly  to slow play backward or forward.

Note

- For BD discs with Java application, availability of the play resume function depends on specific discs.

Change video play

- 1 Play a title.
- 2 Use the remote control to change the play.

Button	Action
AUDIO	Directly select an audio language or channel on a disc.
SUBTITLE	Directly select a subtitle language on a disc.
 OPTIONS	Access the above mentioned actions or more options (e.g. repeat or shuffle play mode).

Note

- Some operations may not work with some discs. See the information accompanying the disc for details.

Display menu

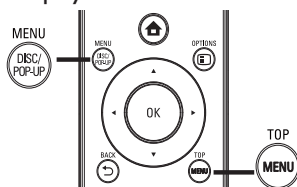

BD-video disc

- **TOP MENU** stop the video play and shows the disc menu. This feature is disc-dependent.
- **POP-UP MENU** access to the BD-video disc menu without interrupting disc play.

DVD-video disc

- **TOP MENU** display the root menu of a disc.
- **DISC MENU** display disc information and guide you through the available functions in the disc.

VCD/SVCD/DivX disc:

- **DISC MENU** display the content of the disc.



Tip

- If the PBC setting is off, the VCD/SVCD skips the menu and starts play from the first title. To display the menu before play, turn on the PBC setting (see "Adjust settings" > [Preference Setup] > [VCD PBC]).

Display play information

- 1 During play, press **OPTION**.
↳ The play options menu is displayed.
- 2 Select [Info] in the menu, and press **OK**.
↳ The current status of disc play is displayed.

Select title/chapter

- 1 During play, press **OPTION**.
↳ The play options menu is displayed.
- 2 Select [Titles] or [Chapters] in the menu, and press **OK**.
- 3 Select the title or chapter number, and press **OK**.

Skip play to a specific time

- 1 During play, press **OPTION**.
↳ The play options menu is displayed.
- 2 Select [Time Search] in the menu, and press **OK**.
- 3 Press the **Navigation buttons** (▲▼) to change the time to skip to, and press **OK**.

Zoom in/out

- 1 During play, press **OPTION**.
↳ The play options menu is displayed.
- 2 Select [Zoom] in the menu, and press **OK**.
- 3 Press the **Navigation buttons** (◀▶) to select a zoom factor; and press **OK**.
- 4 Press the **Navigation buttons** to navigate in the zoomed picture.

- To cancel zoom mode, press **BACK** or **OK** to display the zoom factor bar, and press the **Navigation buttons** (◀▶) until the zoom factor [x1] is selected.

Repeat play for a specific section

- 1 During play, press **OPTION**.
↳ The play options menu is displayed.
- 2 Select [Repeat A-B] in the menu, and press **OK** to set the starting point.
- 3 Forward the video play, and press **OK** to set the ending point.
↳ Repeat play starts.
 - To cancel repeat play mode, press **OPTION**, and select [Repeat A-B] and press **OK**.



Note

- The marked section for repeat play is only possible within a track/title.

View video play from different camera angles

- 1 During play, press **OPTION**.
↳ The play options menu is displayed.
- 2 Select [Angle List] in the menu, and press **▶**.
- 3 Select an angle option, and press **OK**.
↳ Play changes to the selected angle.



Note

- Applicable only to discs that contain multi-angle scenes.

Manually shift subtitle display

You can manually adjust the subtitle position on the TV screen.

- 1 During play, press **OPTION**.
↳ The play options menu is displayed.
- 2 Select [Subtitle Shift] in the menu, and press **OK**.
- 3 Press the **Navigation buttons** (▲▼) to shift the subtitle, and press **OK**.



Tip

- Subtitle shift is not supported for DivX video with external subtitles.

Play BD-video

Blu-ray video disc has a larger capacity and supports features such as high-definition videos, multi-channel surround sounds, interactive menus and so on.

- 1 Insert a BD-video disc.
- 2 Press **▲**, select **[play Disc]** and press **OK**.
- 3 Play automatically starts, or select a play option in the menu and press **OK**.
 - During play, you can press **TOP MENU** to display additional information, features or content stored in the disc.
 - During play, you can press **POP-UP MENU** to display the disc menu without interrupting disc play.

Enjoy BONUSVIEW

(Applicable only to a disc compatible with the BONUSVIEW or Picture-in-Picture feature)

You can instantly view additional content (such as commentaries) in a small screen window.

- 1 Press **≡** **OPTIONS**.
 - ↳ The play options menu is displayed.
- 2 Select **[PIP Selection]** in the menu, and then select **[PIP]**, and press **OK**.
 - ↳ The secondary video window is turned on.
- 3 Select **[2nd Audio Language]** or **[2nd Subtitle Language]** in the menu, and press **▶**.
- 4 Select the language to play, and press **OK**.

Enjoy BD-Live

(Applicable only to a disc that enables BD-Live bonus content.)

Additional contents (such as movie trailers, subtitles, etc.) can be downloaded to this product's local storage or a connected USB storage device. Special video data may be played while they are being downloaded.

When the disc supporting BD-Live is played, this product or disc's ID can be sent to the content provider via the internet. Services and functions to be provided vary from disc to disc.

Play DivX® video

DivX video is a digital media format that retains high quality despite a high rate of compression.

- 1 Insert a disc or USB device that contains the DivX videos.
- 2 Press **▲**, select **[play Disc]** or **[browse USB]**, and press **OK**.
 - ↳ A contents menu is displayed.
- 3 Select a video folder, and press **OK**.

- 4 Select a title to play, and press **OK**.
- 5 Use the remote control to control the play.

Button	Action
AUDIO	Select an audio language or channel.
SUBTITLE	Select a subtitle language.
■	Stop play.

Note

- You can only play DivX videos that were rented or purchased with the DivX registration code of this product (see "Adjust Settings" > **[Advanced Setup]** > **[DivX® VOD Code]**).
- You can play DivX video files of up to 4GB.
- This product can display up to 45 characters in the subtitle.

Play photo

Play photo as slideshow

You can play JPEG photos (files with .jpeg or .jpg extensions).

- 1 Insert a disc or USB device that contains the JPEG photos.
- 2 Press **▲**, select **[play Disc]** or **[browse USB]**, and press **OK**.
 - ↳ A contents menu is displayed.
- 3 Select a photo folder, and press **OK** to enter.
 - To select a photo, press the **Navigation buttons**.
 - To enlarge the selected photo and start slideshow, press **OK**.
- 4 Press **▶** to start slideshow play.

Note

- It may require longer time to display the disc content on the TV if large number of songs/photos compiled onto one disc.
- This product can only display digital camera pictures according to the JPEG-EXIF format, typically used by most digital cameras. It cannot display Motion JPEG, or pictures in formats other than JPEG, or sound clips associated with pictures.
- Folders/files that exceed the supported limit of this product cannot be displayed or played.

Control photo play

- 1 Play a photo slideshow.
- 2 Use the remote control to control the play.
 - Press **OPTIONS** to access play options, select an option, and press **OK**.
 - During slideshow play, you may also press to flip a photo horizontally/vertically.
 - If the slideshow stops, press to continue play.

Set slideshow interval and animation

- 1 During play, press **OPTIONS**.
↳ The play options menu is displayed.
- 2 Select [**Duration per slide**] in the menu, and press **OK**.
- 3 Select a duration, and press **OK**.
- 4 Select [**Slide Animation**] in the menu, and press **OK**.
- 5 Select a type of animation effect, and press **OK**.

Play musical slideshow

Create a musical slideshow to play simultaneously MP3/WMA music files and JPEG photo files.

Note

- To create a musical slideshow, you must store the MP3/WMA and JPEG files on the same disc or USB device.

- 1 Play MP3/WMA music.
- 2 Press **BACK** to return to the main menu.
- 3 Navigate to enter a photo folder, and press **OK** to start slideshow play.
 - ↳ Slideshow begins and continues till the end of the photo folder.
 - ↳ Audio continues to play until the end of the disc.
 - To stop the slideshow play, press .
 - To stop the music play, press again.

Play music

Control a track

- 1 Play a track.
- 2 Use the remote control to control the play.

Button	Action
	Pause play.
	Start or resume play.
	Stop play.
	Skip to a previous/next track.
	Select an item to play.
	Search fast-backward or fast-forward. Press repeatedly to change the search speed.
	Access the repeat or shuffle play mode.

Play MP3/WMA music

MP3/WMA is a type of compressed audio file (files with .mp3, .wma extensions).

- 1 Insert a disc or USB device that contains the MP3/WMA music.
- 2 Press , select [**play Disc**] or [**browse USB**], and then press **OK**.
↳ A contents menu is displayed.
- 3 Select a music folder, and press **OK**.
- 4 Select a file to play, and press **OK**.
 - To return to the main menu, press **BACK**.

Note

- For disc recorded in multiple sessions, only the first session is played.
- For a WMA file that is protected by Digital Rights Management (DRM), it cannot be played on this product.
- This product does not support MP3PRO audio format.
- For any special character that is present in the MP3 track name (ID3) or album name, it might not be displayed correctly on the screen because these characters are not supported.
- Folders/files that exceed the supported limit of this product cannot be displayed or played.

6 Adjust settings

Note

- If the setup option is grayed out, it means the setting cannot be changed at the current state.

Video setup

- 1 Press **▲**.
- 2 Select **[Setup]**, and press **OK**.
- 3 Select **[Video Setup]**, and press **▶**.

Video Setup	TV Display	● 16:9 Widescreen
Audio Setup	HDMI Video	● Auto
Network Setup	HDMI Deep Color	● Auto
EasyLink Setup	Component Video	● 480i/576i
Preference Setup	Picture Settings	● Standard
Advanced Setup		

- 4 Select an option, then press **OK**.
- 5 Select a setting, then press **OK**.
 - To return to the previous menu, press **↶ BACK**.
 - To exit the menu, press **▲**.

[TV Display]

Select a display format:



4:3 Letter Box (LB)



4:3 Pan Scan (PS)



16:9 (Wide Screen)



16:9

- **[4:3 Letterbox]** – For 4:3 screen TV: wide-screen display with black bars on the top and bottom of the screen.
- **[4:3 Panscan]** – For 4:3 screen TV: full-height display with the trimmed sides.
- **[16:9 Widescreen]** – For wide-screen TV: display picture at ratio 16:9.
- **[16:9]** – For 16:9 screen TV: display picture at ratio 4:3 for a disc with 4:3 ratio, with black bars on the left and right side of the screen.

Note

- If **[4:3 Panscan]** you have selected is not supported by the disc, the screen displays in the **[4:3 Letterbox]** format.

[HDMI Video]

Select an HDMI video output resolution that is compatible with your TV display capability.

- **[Auto]** - Detect and select the best supported video resolution automatically.
- **[Native]** - Set to original video resolution.
- **[480i/576i]**, **[480p/576p]**, **[720p]**, **[1080i]**, **[1080p]**, **[1080p/24Hz]** - Select a video resolution setting that best is supported by the TV. See the TV manual for details.

Note

- If a selected video resolution is not supported with your TV and a blank screen appears, to recover picture display, wait for 10 seconds, or on the remote control press **▲** and then press "731" (numeric buttons).
- For a composite (CVBS) or component (YPbPr) connection, if no video output is made when a video resolution under **[HDMI Video]** or **[Component Video]** is set to an HD resolution (1080p/24Hz, 1080p, 1080i, 720p), connect this player to the TV with an HDMI connection to play HD videos.

[HDMI Deep Color]

This feature is available only when the display device is connected by an HDMI cable, and when it supports deep color feature.

- **[Auto]** - Enjoy vivid images in over a billion colors on Deep Color enabled TV.
- **[On]** - Enjoy vivid images in over a billion colors on Deep Color enabled TV. Output 12 bit color that reduces the posterization effect.
- **[Off]** - Output standard 8 bit color.

[Component Video]

Select a component video output resolution that is compatible with the TV display capability.

- **[480i/576i]**, **[480p/576p]**, **[720p]**, **[1080i]** - Select a video resolution setting that is best supported by the TV. See the TV manual for details.

Note

- If the setting is not compatible with the TV, a blank screen appears. Wait for 10 seconds for auto recovery.
- Copy protected DVDs can only output 480p/576p or 480i/576i resolution.

[Picture Settings]

Select a predefined set of picture color settings.

- **[Standard]** – Original color setting.

- **[Vivid]** – Vibrant color setting.
- **[Cool]** - Soft color setting.
- **[Action]** – Sharp color setting. It enhances the details in the dark area. Ideal for action movies.
- **[Animation]** – Contrast color setting. Ideal for animated pictures.

Audio setup

- 1 Press **⏠**.
- 2 Select **[Setup]**, and press **OK**.
- 3 Select **[Audio Setup]**, and press **▶**.

Video Setup	Night Mode	● Off
	Neo 6	● Off
Audio Setup	HDMI Audio	● Auto
Network Setup	Digital Audio	● Auto
EasyLink Setup	PCM Downsampling	● On
Preference Setup		
Advanced Setup		

- 4 Select an option, then press **OK**.
- 5 Select a setting, then press **OK**.
 - To return to the previous menu, press **↶ BACK**.
 - To exit the menu, press **⏠**.

[Night Mode]

Increase a soft sound level such as dialogue to make it easier to hear at a low volume, while simultaneously decreasing a loud sound level.

- **[Auto]** - Detect and select a best sound level at a low volume. Applicable to tracks with Dolby TrueHD audio only.
- **[On]** – For quiet viewing at night.
- **[Off]** – For surround sound with a full dynamic range.

Note

- Applicable only to Dolby encoded DVD-video or BD-video.

[Neo 6]

A post processing by DTS to generate a surround sound effect from 2 channel audio.

- **[Cinema]** – Enable Neo 6 post processing to the cinema mode.
- **[Music]** - Enable Neo 6 post processing to the music mode.
- **[Off]** – Disable Neo 6 post processing.

[HDMI Audio]

Select an HDMI audio output when you connect this product and the TV/audio device with an HDMI cable.

- **[Bitstream]** – Select the best original HD audio experience (only via an HD audio compatible receiver).
- **[Auto]** – Detect and select the best supported audio format automatically.

[Digital Audio]

Select an audio format for the sound output from the DIGITAL OUT jack (coaxial/optical).

- **[Auto]** - Detect and select the best supported audio format automatically.
- **[PCM]** - The audio device does not support multi-channel format. Audio is downmixed to two-channel sound.
- **[Bitstream]** - Select the original audio to experience Dolby or DTS audio (BD-video special sound effect is disabled).

Note

- Ensure that the audio format is supported by the disc and the connected audio device (amplifier/receiver).
- When **[Bitstream]** is selected, interactive audio like button sound is muted.

[PCM Downsampling]

Set the sampling rate for PCM audio output from the DIGITAL OUT jack (coaxial/optical).

- **[On]** - PCM audio is down-sampled at 48kHz.
- **[Off]** - For BD or DVD recorded in LPCM without copyright protection, two-channel audio signals up to 96 kHz are output as LPCM signals with no conversion.

Network setup

- 1 Press **⏠**.
- 2 Select **[Setup]**, and press **OK**.
- 3 Select **[Network Setup]**, and press **▶**.

Video Setup	Network Installation	●
	View Network Settings	●
Audio Setup		
Network Setup		
EasyLink Setup		
Preference Setup		
Advanced Setup		

- 4 Select an option, then press **OK**.
- 5 Select a setting, then press **OK**.
 - To return to the previous menu, press **↶ BACK**.
 - To exit the menu, press **🏠**.

[Network Installation]

Install the network connection.

[View Network Settings]

Display the information for the current network status.

EasyLink setup

- 1 Press **🏠**.
- 2 Select **[Setup]**, and press **OK**.
- 3 Select **[EasyLink Setup]**, and press **▶**.

Video Setup	EasyLink ● On
Audio Setup	One Touch Play ● On
Network Setup	One Touch Standby ● On
EasyLink Setup	
Preference Setup	
Advanced Setup	

- 4 Select an option, and press **OK**.
- 5 Select a setting, and press **OK**.
 - To return to the previous menu, press **↶ BACK**.
 - To exit the menu, press **🏠**.

[EasyLink]

This product supports Philips Easylink which uses the HDMI CEC (Consumer Electronics Control) protocol. You can use one single remote control to control all EasyLink-compliant devices that are connected through HDMI connectors.

- **[On]** - Turn on EasyLink features.
- **[Off]** - Disable EasyLink features.

[One Touch Play]

When you press **⏻** (standby) to turn on this product, the TV (if the TV supports one-touch play) automatically turns on and switches to the video-in channel. Disc play starts if there is a disc in this product.

- **[On]** - Turn on one-touch play feature.
- **[Off]** - Disable one-touch play feature.

[One Touch Standby]

When you press and hold **⏻** (standby), all the connected HDMI CEC devices (if the device supports one-touch standby) switch to standby mode simultaneously.

- **[On]** - Turn on one-touch standby feature.
- **[Off]** - Disable one-touch standby feature.

Note

- You must turn on the HDMI CEC operations on the TV/ devices before you can enjoy the EasyLink controls. See the TV/devices manual for details.
- Philips does not guarantee 100% interoperability with all HDMI CEC compliant devices.

Preference setup

- 1 Press **🏠**.
- 2 Select **[Setup]**, and press **OK**.
- 3 Select **[Preference Setup]**, and press **▶**.

Video Setup	Menu Language ● English
Audio Setup	Audio ● English
Network Setup	Subtitle ● Off
EasyLink Setup	Disc Menu ● English
Preference Setup	Parental Control ● Off
Advanced Setup	Screen Saver ● On
	Auto Subtitle Shift ● On
	Change Password ●

- 4 Select an option, then press **OK**.
- 5 Select a setting, then press **OK**.
 - To return to the previous menu, press **↶ BACK**.
 - To exit the menu, press **🏠**.

[Menu Language]

Select an on-screen menu language.

Note

- If this product is connected to an HDMI CEC compliant TV using a HDMI cable, it switches automatically to the same menu display language as per your TV setting (if the language set on TV is supported by this product).

[Audio]

Select an audio language for disc play.

[Subtitle]

Select a subtitle language for disc play.

[Disc Menu]

Select a language for disc menu.

Note

- If the language you have set is not available on the disc, the disc uses its own default language.
- For some discs, the subtitle/audio language can only be changed from the disc menu.

[Parental Control]

Restrict access to discs that are unsuitable for children. These types of discs must be recorded with ratings.

To access, enter your last set password or '0000'.

Note

- Rated discs above the level you set in **[Parental Control]** require a password to be played.
- The ratings are country-dependent. To allow all discs to play, select '8' for DVD-video and BD-Video.
- Some discs have ratings printed on them but are not recorded with ratings. This function has no effect on such discs.

[Screen Saver]

Turn on or off the screen saver mode. It helps to protect the TV screen from being damaged due to over exposure to static image for being too long.

- **[On]** - Set the screen saver active after 10 minutes of inactivity (for example, in the pause or stop mode)
- **[Off]** - Disable screen saver mode.

[Auto Subtitle Shift]

Turn on or off the automatic subtitle shift.

- **[On]** - The subtitle position on the TV screen is automatically adjusted.
- **[Off]** - Disable the automatically subtitle shift.

[Change Password]

Set or change the password.

- 1) Press the Numeric buttons to enter the password or your last set password. If you forget the password, enter '0000', then press **OK**.
- 2) Enter the new password.
- 3) Enter the same password again.
- 4) Move to **[Confirm]** in the menu and press **OK**.

[Display Panel]

Select a brightness level of the front panel display.

- **[Normal]** - Normal brightness.
- **[Dim]** - To dim display.

[Auto Standby]

Turn on or off auto standby mode. It is an energy saving feature.

- **[On]** - Switch to standby after 30 minutes of inactivity (for example, in pause or stop mode).
- **[Off]** - Disable auto standby mode.

[VCD PBC]

Turn on or off the content menu of VCDs/SVCDs with PBC (playback control) feature.

- **[On]** - Display the index menu when you load a disc for play.
- **[Off]** - Skip the menu and start play from the first title.

Advanced setup

- 1 Press **Home**.
- 2 Select **[Setup]**, and press **OK**.
- 3 Select **[Advanced Setup]**, and press **Right**.

Video Setup	BD Live Security	● Off
Audio Setup	Software Update	●
Network Setup	Clear Memory	●
EasyLink Setup	DivX® VOD Code	●
Preference Setup	Version Info.	●
Advanced Setup	Restore Default Settings	●

- 4 Select an option, and press **OK**.
- 5 Select a setting, and press **OK**.
 - To return to the previous menu, press **Left** **BACK**.
 - To exit the menu, press **Home**.

[BD-Live Security]

You can restrict internet access for BD-Live bonus contents which are available to certain Blu-ray discs.

- **[On]** - Internet access is prohibited for all BD-Live contents.
- **[Off]** - Internet access is permitted for all BD-Live contents.

[Software Update]

Update the software of this product (if a latest version is available on Philips website) to enhance the performance of this product.

- **[USB]** - Update software from the USB device which is connected to this product.
- **[Network]** - Update software from the internet.

Note

- For detailed software updating, see "Additional information" > "Update software".

[Clear Memory]

Delete BD-Live data that are automatically downloaded on the connected USB device.

Tip

- On the connected USB device, a folder named "BUDA" is automatically created to store the downloaded BD-Live data.

[DivX® VOD Code]

Obtain the DivX® registration code or the deregistration code.

Tip

- Use this product's DivX registration code when you rent or purchase video from www.divx.com/vod. The DivX videos rented or purchased through the DivX® VOD (Video On Demand) service can be played only on the device to which it is registered.

[Version Info.]

Display the software version and the MAC address of this product.

Tip

- This information is needed for you to check if a latest software version is available at the Philips website so that you can download and install on this product.

[Restore Default Settings]

Reset all the settings of this product to the factory settings, except for **[Parental Control]** setting.

7 Additional Information

Update software

For software updates to enhance performance, check the current software version of this product to compare with the latest software (if available) at the Philips website.

- 1 Press **▲**.
- 2 Select **[Setup]**, and press **OK**.
- 3 Select **[Advanced Setup]** > **[Version Info.]**, and press **OK**.

Update software via network

- 1 Set up the internet connection (see "Get started" > "Set up a network").
- 2 In the Home menu, select **[Setup]** > **[Advanced Setup]** > **[Software Update]** > **[Network]**.
 - ↳ You are prompted to start upgrading process if upgrade media is detected.
- 3 Follow the instructions on the TV screen to confirm update operation.
 - ↳ Once software update is complete, this product automatically turns off to standby.

Update software via USB

- 1 Go to www.philips.com/support to check if the latest software version is available for this product.
- 2 Download the software into a USB flash drive:
 - ① Un-zip the download, and make sure that the un-zipped folder is named "UPG".
 - ② Put the "UPG" folder in the root directory.
- 3 Insert the USB flash drive to the **↔ (USB)** jack on this product.
- 4 In the Home menu, select **[Setup]** > **[Advanced Setup]** > **[Software Update]** > **[USB]**.
- 5 Follow the instructions on the TV screen to confirm update operation.
 - ↳ Once software update is complete, this product automatically turns off to standby.

Note

- Do not turn off the power or remove the USB flash drive when software updating is in progress to prevent possible damage of this product.

Care

! Caution

- Never use solvents such as benzene, thinner, cleaners available commercially, or anti-static sprays intended for discs.

Clean discs

Wipe the disc with a micro fibre cleaning cloth from the centre to the edge in a straight line movement.

Specifications

Note

- Specifications are subject to change without notice

Video

- Signal system: PAL / NTSC
- Composite video output: 1 Vp-p (75 ohm)
- Component video output: 480/576i, 480/576p, 720p, 1080i
 - Y: 1 Vp-p (75 ohm)
 - Pb: 0.7 V-pp (75 ohm)
 - Pr: 0.7 V-pp (75 ohm)
- HDMI output 480p, 576p, 720p, 1080i, 1080p, 1080p24

Audio

- 2 Channel analog output
 - Audio Front L&R: 2 Vrms (> 1 kohm)
- Digital output: 0.5 Vp-p (75 ohm)
 - Coaxial
- HDMI output
- Sampling frequency:
 - MP3: 32 kHz, 44.1 kHz, 48 kHz
 - WMA: 44.1 kHz, 48 kHz
- Constant bit rate:
 - MP3: 112 kbps - 320 kbps
 - WMA: 48 kbps - 192 kbps

USB

- Compatibility: Hi-Speed USB (2.0)
- Class support: UMS (USB Mass Storage Class)

Main unit

- Power supply rating: 220~240V ~AC, ~50 Hz
- Power consumption: 25 W
- Power consumption in standby mode: < 0.5 W
- Dimensions (w x h x d): 435 x 60 x 227 (mm)
- Net Weight: 2.35 kg

Accessories supplied

- Remote control and batteries
- Audio/Video cables
- Power cable
- Quick start guide
- User manual

Laser Specification

- Laser Type:
 - BD Laser Diode: AlGaInN
 - DVD Laser Diode: AlGaInP
 - CD Laser Diode: AlGaInP

- Wave length:
 - BD: 405 +5nm/-5nm
 - DVD: 655 +10nm/-10nm
 - CD: 790 +10nm/-20nm
- Output power:
 - BD: Max. ratings: 20mW
 - DVD: Max. ratings: 6mW
 - CD: Max. ratings: 7mW

8 Troubleshooting



Warning

- Risk of electric shock. Never remove the casing of the product.

To keep the warranty valid, never try to repair the product yourself.

If you have problems using this product, check the following points before you request service. If you still have a problem, register your product and get support at www.philips.com/welcome.

Main unit

No reaction to the remote control.

- Connect this product to the power outlet.
- Point the remote control at the IR sensor located on the front panel of this product.
- Insert the batteries correctly.
- Insert new batteries in the remote control.

Picture

No picture.

- See TV manual for correct video input selection. Change the TV channel until you see the Philips screen.

No picture on HDMI connection.

- If this product is connected to an unauthorized display device with an HDMI cable, the audio/video signal may not be output.
- Check if the HDMI cable is faulty. Replace a new HDMI cable.
- On the remote control, press  and then press "731" (numeric buttons) to recover picture display.

No high-definition video signal on the TV.

- Make sure that the disc contains high-definition video.
- Make sure that the TV supports high-definition video.

Sound

No audio output from the TV.

- Ensure that the audio cables are connected to the audio input of the TV.
- Assign the audio input of the TV to the corresponding video input. See the TV user manual for details.

No audio output from the loudspeakers of the audio device (home theater /amplifier/receiver).

- Ensure that the audio cables are connected to the audio input of the audio device.
- Turn on the audio device to its correct audio input source.

No sound on HDMI connection.

- You may not hear any sound from the HDMI output if the connected device is non-HDCP compliant or only DVI-compatible.

No secondary audio output for Picture-in-Picture feature.

- When [Bitstream] under the [HDMI Audio] or [Digital Audio] menu is selected, interactive sound like secondary sound for Picture-in-Picture feature is muted. Deselect [Bitstream].

Play

Disc cannot be played.

- Ensure that the disc is correctly loaded.
- Ensure that this product supports the disc. See "Your product" > "Playable media".
- Ensure that this product supports the region code of the DVD or BD.
- For DVD±RW or DVD±R, ensure that the disc is finalized.
- Clean the disc.

Data files (JPEG, MP3, WMA) cannot be played or read.

- Ensure that the data file was recorded in the UDF, ISO9660 or JOLIET format.
- Ensure that the selected group (folder) does not contain more than 9,999 files for DVD, and 999 files for CD.
- Ensure that the JPEG file extension is .jpg, .JPG, .jpeg or .JPEG.
- Ensure that the MP3/WMA file extension is .mp3 or .MP3, and .wma or .WMA for windows Media™ Audio.

DivX video files cannot be played.

- Ensure that the DivX video file is complete.
- Ensure that the file name extension is correct.

The contents of the USB flash drive cannot be read.

- The USB flash drive format is not compatible with this product.
- Maximum size of memory supported is 160GB.

'No entry' or 'x' sign appears on the TV.

- The operation is not possible.

EasyLink feature does not work.

- Ensure that this product is connected to the Philips brand EasyLink TV and the [EasyLink] in the menu is set to [On].

Unable to access BD-Live feature.

- Check the network connection or ensure that the network has been set up.
- Clear local storage, internal memory (if any) or USB.
- Ensure that the BD disc supports BD Live feature.

9 Glossary

A

Aspect ratio

Aspect ratio refers to the width to height ratio of TV screens. The ratio of a standard TV is 4:3, while the ratio of a high-definition or wide TV is 16:9. The letter box allows you to enjoy a picture with a wider perspective on a standard 4:3 screen.

AVCHD

AVCHD is a format (standard) for high definition video cameras that can be used to record and play high-resolution HD images.

B

Blu-ray Disc (BD)

Blu-ray Disc is a next generation optical video disc capable of storing five times more data than a conventional DVD. The large capacity makes it possible to benefit from the features such as high-definition videos, multichannel surround sound, interactive menus and so on.

BONUSVIEW

BonusView, also known as "Profile 1.1": In addition to basic playback and interactive features, BonusView players introduced after 31st October, 2007 enables users to enjoy 'Picture-in-Picture' (PiP) and secondary audio features (useful when playing games that use additional audio stream while the movie is playing) on compatible BonusView discs.

D

Digital Audio

Digital Audio is a sound signal that has been converted into numerical values. Digital sound can be transmitted through multiple channels. Analogue sound can only be transmitted through two channels.

DivX Video-On-Demand

This DivX Certified[®] device must be registered in order to play DivX Video-on-Demand (VOD) content. To generate the registration code, locate the DivX VOD section in your device setup menu. Go to vod.divx.com with this code to complete the registration process and learn more about DivX video.

Dolby Digital

A surround sound system developed by Dolby Laboratories that contains up to six channels of digital audio (front left and right, surround left and right, center and subwoofer).

DTS

Digital Theatre Systems. A surround sound system for providing 5.1 channels of discrete digital audio in consumer electronics products and software content. It is not developed by Dolby Digital.

H

HDCP

High-bandwidth Digital Content Protection. This is a specification that provides a secure transmission of digital contents between different devices (to prevent unauthorized copying.)

HDMI

High-Definition Multimedia Interface (HDMI) is a high-speed digital interface that can transmit uncompressed high definition video and digital multichannel audio. It delivers high quality picture and sound quality, completely free from noise. HDMI is fully backward-compatible with DVI. As required by the HDMI standard, connecting to HDMI or DVI products without HDCP (High-bandwidth Digital Content Protection) will result in no Video or Audio output.

J

JPEG

A very common digital still picture format. A still-picture data compression system proposed by the Joint Photographic Expert Group, which features small decrease in image quality in spite of its high

compression ratio. Files are recognized by their file extension '.jpg' or '.jpeg.'

L

LAN (Local Area Network)

A group of linked devices in a company, school or home. Indicates the boundaries of a particular network.

Local storage

This storage area is used as destination for storing additional contents from BD-Live enabled BD-Video.

M

MP3

A file format with a sound data compression system. MP3 is the abbreviation of Motion Picture Experts Group 1 (or MPEG-1) Audio Layer 3. With the MP3 format, one CD-R or CD-RW can contain about 10 times more data than a regular CD.

P

PBC

Playback Control. A system where you navigate through a Video CD/Super VCD with on-screen menus that are recorded onto the disc. You can enjoy interactive playback and search.

PCM

Pulse Code Modulation. A digital audio encoding system.

R

Region code

A system that allows discs to be played only in the region designated. This unit only plays discs that have compatible region codes. You can find the region code of your unit on the product label. Some discs are compatible with more than one region (or ALL regions.)

W

WMA

Windows Media[™] Audio. Refers to an audio compression technology developed by Microsoft Corporation. WMA data can be encoded with Windows Media player version 9 or Windows Media player for Windows XP. Files are recognized by their file extension '.wma.'

NOTICE

SOFTWARE END USER LICENSE AGREEMENT

THIS SOFTWARE END USER LICENSE AGREEMENT ("THIS AGREEMENT") IS A LEGAL AND BINDING AGREEMENT BETWEEN YOU (EITHER AN INDIVIDUAL OR ENTITY) AND PHILIPS CONSUMER LIFESTYLE B.V. A DUTCH LIMITED LIABILITY COMPANY, WITH ITS PRINCIPAL OFFICE AT HIGH TECH CAMPUS 37, 5656 AE EINDHOVEN, THE NETHERLANDS AND ITS SUBSIDIARY COMPANIES (INDIVIDUALLY AND COLLECTIVELY "PHILIPS"). THIS AGREEMENT GIVES YOU THE RIGHT TO USE CERTAIN SOFTWARE (THE "SOFTWARE") INCLUDING USER DOCUMENTATION IN ELECTRONIC FORM WHICH MAY HAVE BEEN PROVIDED SEPARATELY OR TOGETHER WITH A PHILIPS PRODUCT (THE "DEVICE") OR A PC. BY DOWNLOADING, INSTALLING OR OTHERWISE USING THE SOFTWARE, YOU ACCEPT AND AGREE TO BE BOUND BY ALL OF THE TERMS AND CONDITIONS OF THIS AGREEMENT. IF YOU DO NOT AGREE TO THESE TERMS AND CONDITIONS, DO NOT DOWNLOAD, INSTALL OR OTHERWISE USE THE SOFTWARE. IF YOU ACQUIRED THE SOFTWARE IN TANGIBLE MEDIA E.G. CD WITHOUT THE OPPORTUNITY TO REVIEW THIS LICENSE AND DO NOT ACCEPT THESE TERMS, YOU MAY RECEIVE A FULL REFUND OF THE AMOUNT, IF ANY, THAT YOU PAID FOR THE SOFTWARE IF YOU RETURN THE SOFTWARE UNUSED WITH PROOF OF PAYMENT WITHIN 30 DAYS FROM THE DATE OF PURCHASE.

- 1. Grant of License.** This Agreement grants you a non-exclusive, nontransferable, non-sub licensable license to install and use, on the Device or a PC, as applicable, one (1) copy of the specified version of the Software in object code format as set out in the user documentation solely for your personal use. The Software is "in use" when it is loaded into the temporary or permanent memory (i.e. RAM, hard disk, etc.) of the PC or the Device.
- 2. Ownership.** The Software is licensed and not sold to you. This Agreement grants you only the right to use the Software, but you do not acquire any rights, express or implied, in the Software other than those specified in this Agreement. Philips and its licensors retain all right, title, and interest in and to the Software, including all patents, copyrights, trade secrets, and other intellectual property rights incorporated therein. The Software is protected by copyright laws, international treaty provisions, and other intellectual property laws. Therefore, other than as expressly set forth herein, you may not copy the Software without prior written authorization of Philips, except that you may make one (1) copy of the Software for your back-up purposes only. You may not copy any printed materials accompanying the Software, nor print more than one (1) copy of any user documentation provided in electronic form, except that you may make one (1) copy of such printed materials for your back-up purposes only.
- 3. License Restrictions.** Except as provided otherwise herein, you shall not rent, lease, sublicense, sell, assign, loan, or otherwise transfer the Software. You shall not, and you shall not permit any third party, to reverse engineer, decompile, or disassemble the Software, except to the extent that applicable law expressly prohibits the foregoing restriction. You may not remove or destroy any product identification, copyright notices, or other proprietary markings or restrictions from the Software. All titles, trademarks, and copyright and restricted rights notices shall be reproduced on your back up copy of the Software. You may not modify or adapt the Software, merge the Software into another program or create derivative works based upon the Software.
- 4. Termination of certain functionality.** The Software may contain components of certain licensed software including software licensed from Microsoft Corporation ("Microsoft") which implements Microsoft's digital rights management technology for Windows Media. Content providers are using the digital rights management technology for Windows Media ("WM-DRM") to protect the integrity of their content ("Secure Content") so that their intellectual property, including copyright, in such content is not misappropriated. Your Device may also use WM-DRM software to transfer or play Secure Content ("WM-DRM Software"). If the security of such WM-DRM Software is compromised, Microsoft may revoke (either on its own or upon the request of the owners of Secure Content ("Secure Content Owners")) the WM-DRM Software's right to acquire new licenses to copy, store, transfer, display and/or play Secure Content. Revocation does not alter the WM-DRM Software's ability to play unprotected content. A list of revoked WM-DRM Software is sent to your PC and/or your Device whenever you download a license for Secure Content. Microsoft may, in conjunction with such license, also download revocation lists onto your Device on behalf of Secure Content Owners, which may disable your Device's ability to copy, store, display, transfer, and/or play Secure Content. Secure Content Owners may also require you to upgrade some of the WM-DRM components distributed with this Software ("WM-DRM Upgrades") before accessing their content. When you attempt to play Secure Content, WM-DRM Software built by Microsoft will notify you that a WM-DRM Upgrade is required and then ask for your consent before the WM-DRM Upgrade is downloaded. WM-DRM Software built by Philips may do the same. If you decline

the upgrade, you will not be able to access Secure Content that requires the WM-DRM Upgrade; however, you will still be able to access unprotected content and Secure Content that does not require the upgrade. WM-DRM features that access the Internet, such as acquiring new licenses and/or performing a required WM-DRM Upgrade, can be switched off. When these features are switched off, you will still be able to play Secure Content if you have a valid license for such content already stored on your Device. However, you will not be able to use certain of the WM-DRM Software features that require Internet access such as the ability to download content that requires the WM-DRM Upgrade. All title and intellectual property rights in and to the Secure Content is the property of the respective Secure Content owners and may be protected by applicable copyright or other intellectual property laws and treaties. This Agreement grants you no rights to use such Secure Content. **To summarize, if the Software contains Microsoft WM-DRM components – Secure Content you desire to download, copy, store, display, transfer, and/or play is protected by the Microsoft WM-DRM components of the Software. Microsoft, Secure Content Owners, or Secure Content distributors may deny you access, or restrict your access, to Secure Content even after you have paid for, and/or obtained, it. Neither your consent nor the consent or approval of Philips is necessary for any of them to deny, withhold or otherwise restrict your access to Secure Content. Philips does not guaranty that you will be able to download, copy, store, display, transfer, and/or play Secure Content.**

5. **Open Source Software.** (a) This software may contain components that are subject to open-source terms, as stated in the documentation accompanying the Device. This Agreement does not apply to this software as such. (b) Your license rights under this Agreement do not include any right or license to use, distribute or create derivative works of the Software in any manner that would subject the Software to Open Source Terms. "Open Source Terms" means the terms of any license that directly or indirectly (1) create, or purport to create, obligations for Philips with respect to the Software and/or derivative works thereof; or (2) grant, or purport to grant, to any third party any rights or immunities under intellectual property or proprietary rights in the Software or derivative works thereof.
6. **Termination.** This Agreement shall be effective upon installation or first use of the Software and shall terminate (i) at the discretion of Philips, due to your failure to comply with any term of this Agreement; or (ii) upon destruction of all copies of the Software and related materials provided to you by Philips hereunder. Philips's rights and your obligations shall survive the termination of this Agreement.
7. **Upgrades.** Philips may, at its sole option, make upgrades to the Software available by general posting on a website or by any other means or methods. Such upgrades may be made available pursuant to the terms of this Agreement or the release of such upgrades to you may be subject to your acceptance of another agreement.
8. **Support Services.** Philips is not obligated to provide technical or other support ("Support Services") for the Software. If Philips does provide you with Support Services, these will be governed by separate terms to be agreed between you and Philips.
9. **Limited Software Warranty.** Philips provides the Software 'as is' and without any warranty except that the Software will perform substantially in accordance with the documentation accompanying the Software for a period of one year after your first download, installation or use of the Software, whichever occurs first. Philips' entire liability and your exclusive remedy for breach of this warranty shall be, at Philips' option, either (i) return of the price paid by you for the Software (if any); or (b) repair or replacement of the Software that does not meet the warranty set forth herein and that is returned to Philips with a copy of your receipt. This limited warranty shall be void if failure of the Software has resulted from any accident, abuse, misuse or wrongful application. Any replacement Software will be warranted for the remainder of the original warranty period or thirty (30) days, whichever is longer. This limited warranty shall not apply to you if the Software was provided to you free of charge on an evaluation only basis.
10. **NO OTHER WARRANTIES.** EXCEPT AS SET FORTH ABOVE, PHILIPS AND ITS LICENSORS DO NOT WARRANT THAT THE SOFTWARE WILL OPERATE ERROR FREE OR UNINTERRUPTED, OR WILL MEET YOUR REQUIREMENTS. YOU ASSUME ALL RESPONSIBILITIES FOR SELECTION OF THE SOFTWARE TO ACHIEVE YOUR INTENDED RESULTS, AND FOR THE INSTALLATION OF, USE OF, AND RESULTS OBTAINED FROM THE SOFTWARE. TO THE MAXIMUM EXTENT PERMITTED BY APPLICABLE LAW, PHILIPS AND ITS LICENSORS DISCLAIM ALL WARRANTIES AND CONDITIONS, WHETHER EXPRESS OR IMPLIED, INCLUDING BUT NOT LIMITED TO THE IMPLIED WARRANTIES OF MERCHANTABILITY, FITNESS FOR A PARTICULAR PURPOSE, AND ACCURACY OR COMPLETENESS OF RESULTS WITH RESPECT TO THE SOFTWARE AND THE ACCOMPANYING MATERIALS. THERE IS NO WARRANTY AGAINST INFRINGEMENT. PHILIPS DOES NOT WARRANT THAT YOU WILL BE ABLE TO DOWNLOAD, COPY, STORE, DISPLAY, TRANSFER, AND/OR PLAY SECURE CONTENT.

- 11. LIMITATION OF LIABILITY.** UNDER NO CIRCUMSTANCES WILL PHILIPS OR ITS LICENSORS BE LIABLE FOR ANY CONSEQUENTIAL, SPECIAL, INDIRECT, INCIDENTAL OR PUNITIVE DAMAGES WHATSOEVER, INCLUDING, WITHOUT LIMITATION, DAMAGES FOR LOSS OF PROFITS OR REVENUES, BUSINESS INTERRUPTION, LOSS OF BUSINESS INFORMATION, LOSS OF DATA, LOSS OF USE OR OTHER PECUNIARY LOSS, EVEN IF PHILIPS OR ITS LICENSORS HAVE BEEN ADVISED OF THE POSSIBILITY OF SUCH DAMAGES. IN NO EVENT SHALL PHILIPS' OR ITS LICENSORS' AGGREGATE LIABILITY FOR DAMAGES ARISING OUT OF THIS AGREEMENT EXCEED THE GREATER OF THE PRICE ACTUALLY PAID BY YOU FOR THE SOFTWARE OR FIVE POUNDS STERLING (5.00).
- 12. Trademarks.** Certain of the product and Philips names used in this Agreement, the Software, and the printed user documentation may constitute trademarks of the Philips, its licensors or other third parties. You are not authorized to use any such trademarks.
- 13. Export Administration.** You agree that you will not directly or indirectly, export or re-export the Software to any country for which the United States Export Administration Act, or any similar United States law or regulation requires an export license or other U.S. Government approval, unless the appropriate export license or approval has first been obtained. By downloading or installing the Software you agree to abide by this Export provision.
- 14. Governing law.** This Agreement is governed by the laws of your country of residence, without reference to its conflict of laws principles. Any dispute between you and Philips regarding this Agreement shall be subject to the non-exclusive jurisdiction of the courts of your country of residence.
- 15. General.** This Agreement contains the entire agreement between you and Philips and supersedes any prior representation, undertaking or other communication or advertising with respect to the Software and user documentation. If any part of this Agreement is held invalid, the remainder of this Agreement will continue in full force and effect. This Agreement shall not prejudice the statutory rights of any party dealing as a consumer.

License Texts and Acknowledgements for any open source software used in this Philips product

Instructions to obtain source code for this software can be found in the user manual.

1. U-boot

```
#
# (C) Copyright 2000 - 2008
# Wolfgang Denk, DENX Software Engineering, wd@denx.de.
#
# See file CREDITS for list of people who contributed to this
# project.
#
# This program is free software; you can redistribute it and/or
# modify it under the terms of the GNU General Public License as
# published by the Free Software Foundation; either version 2 of
# the License, or (at your option) any later version.
#
# This program is distributed in the hope that it will be useful,
# but WITHOUT ANY WARRANTY; without even the implied warranty of
# MERCHANTABILITY or FITNESS FOR A PARTICULAR PURPOSE. See the
# GNU General Public License for more details.
#
# You should have received a copy of the GNU General Public License
# along with this program; if not, write to the Free Software
# Foundation, Inc., 59 Temple Place, Suite 330, Boston,
# MA 02111-1307 USA
#
A copy of the GPL is included below at item 2.
```

2. Linux kernel

NOTE! This copyright does *not* cover user programs that use kernel services by normal system calls - this is merely considered normal use of the kernel, and does *not* fall under the heading of "derived work". Also note that the GPL below is copyrighted by the Free Software Foundation, but the instance of code that it refers to (the linux kernel) is copyrighted by me and others who actually wrote it. Also note that the only valid version of the GPL as far as the kernel is concerned is `_this_` particular version of the license (ie v2, not v2.2 or v3.x or whatever), unless explicitly otherwise stated.

Linus Torvalds

GNU GENERAL PUBLIC LICENSE
Version 2, June 1991

Copyright (C) 1989, 1991 Free Software Foundation, Inc.
675 Mass Ave, Cambridge, MA 02139, USA

Everyone is permitted to copy and distribute verbatim copies of this license document, but changing it is not allowed.

Preamble

The licenses for most software are designed to take away your freedom to share and change it. By contrast, the GNU General Public License is intended to guarantee your freedom to share and change free software--to make sure the software is free for all its users. This General Public License applies to most of the Free Software Foundation's software and to any other program whose authors commit to using it. (Some other Free Software Foundation software is covered by the GNU Library General Public License instead.) You can apply it to your programs, too.

When we speak of free software, we are referring to freedom, not price. Our General Public Licenses are designed to make sure that you have the freedom to distribute copies of free software (and charge for this service if you wish), that you receive source code or can get it if you want it, that you can change the software or use pieces of it in new free programs; and that you know you can do these things.

To protect your rights, we need to make restrictions that forbid anyone to deny you these rights or to ask you to surrender the rights. These restrictions translate to certain responsibilities for you if you distribute copies of the software, or if you modify it.

For example, if you distribute copies of such a program, whether gratis or for a fee, you must give the recipients all the rights that you have. You must make sure that they, too, receive or can get the source code. And you must show them these terms so they know their rights.

We protect your rights with two steps: (1) copyright the software, and (2) offer you this license which gives you legal permission to copy, distribute and/or modify the software.

Also, for each author's protection and ours, we want to make certain that everyone understands that there is no warranty for this free software. If the software is modified by someone else and passed on, we want its recipients to know that what they have is not the original, so that any problems introduced by others will not reflect on the original authors' reputations.

Finally, any free program is threatened constantly by software patents. We wish to avoid the danger that redistributors of a free program will individually obtain patent licenses, in effect making the program proprietary. To prevent this, we have made it clear that any patent must be licensed for everyone's free use or not licensed at all.

The precise terms and conditions for copying, distribution and modification follow.

GNU GENERAL PUBLIC LICENSE TERMS AND CONDITIONS FOR COPYING, DISTRIBUTION AND MODIFICATION

0. This License applies to any program or other work which contains a notice placed by the copyright holder saying it may be distributed under the terms of this General Public License. The "Program", below, refers to any such program or work, and a "work based on the Program" means either the Program or any derivative work under copyright law: that is to say, a work containing the Program or a portion of it, either verbatim or with modifications and/or translated into another language. (Hereinafter, translation is included without limitation in the term "modification".) Each licensee is addressed as "you".

Activities other than copying, distribution and modification are not covered by this License; they are outside its scope. The act of running the Program is not restricted, and the output from the Program is covered only if its contents constitute a work based on the Program (independent of having been made by running the Program). Whether that is true depends on what the Program does.

1. You may copy and distribute verbatim copies of the Program's source code as you receive it, in any medium, provided that you conspicuously and appropriately publish on each copy an appropriate copyright notice and disclaimer of warranty; keep intact all the notices that refer to this License and to the absence of any warranty; and give any other recipients of the Program a copy of this License along with the Program.

You may charge a fee for the physical act of transferring a copy, and you may at your option offer warranty protection in exchange for a fee.

2. You may modify your copy or copies of the Program or any portion of it, thus forming a work based on the Program, and copy and distribute such modifications or work under the terms of Section 1 above, provided that you also meet all of these conditions:

- a) You must cause the modified files to carry prominent notices stating that you changed the files and the date of any change.
- b) You must cause any work that you distribute or publish, that in whole or in part contains or is derived from the Program or any part thereof, to be licensed as a whole at no charge to all third parties under the terms of this License.
- c) If the modified program normally reads commands interactively when run, you must cause it, when started running for such interactive use in the most ordinary way, to print or display an announcement including an appropriate copyright notice and a notice that there is no warranty (or else, saying that you provide a warranty) and that users may redistribute the program under these conditions, and telling the user how to view a copy of this License. (Exception: if the Program itself is interactive but does not normally print such an announcement, your work based on the Program is not required to print an announcement.)

These requirements apply to the modified work as a whole. If identifiable sections of that work are not derived from the Program, and can be reasonably considered independent and separate works in themselves, then this License, and its terms, do not apply to those sections when you distribute them as separate works. But when you distribute the same sections as part of a whole which is a work based on the Program, the distribution of the whole must be on the terms of this License, whose permissions for other licensees extend to the entire whole, and thus to each and every part regardless of who wrote it.

Thus, it is not the intent of this section to claim rights or contest your rights to work written entirely by you; rather, the intent is to exercise the right to control the distribution of derivative or collective works based on the Program.

In addition, mere aggregation of another work not based on the Program with the Program (or with a work based on the Program) on a volume of a storage or distribution medium does not bring the other work under the scope of this License.

3. You may copy and distribute the Program (or a work based on it, under Section 2) in object code or executable form under the terms of Sections 1 and 2 above provided that you also do one of the following:
 - a) Accompany it with the complete corresponding machine-readable source code, which must be distributed under the terms of Sections 1 and 2 above on a medium customarily used for software interchange; or,
 - b) Accompany it with a written offer, valid for at least three years, to give any third party, for a charge no more than your cost of physically performing source distribution, a complete machine-readable copy of the corresponding source code, to be distributed under the terms of Sections 1 and 2 above on a medium customarily used for software interchange; or,
 - c) Accompany it with the information you received as to the offer to distribute corresponding source code. (This alternative is allowed only for noncommercial distribution and only if you received the program in object code or executable form with such an offer, in accord with Subsection b above.)

The source code for a work means the preferred form of the work for making modifications to it. For an executable work, complete source code means all the source code for all modules it contains, plus any associated interface definition files, plus the scripts used to control compilation and installation of the executable. However, as a special exception, the source code distributed need not include anything that is normally distributed (in either source or binary form) with the major components (compiler, kernel, and so on) of the operating system on which the executable runs, unless that component itself accompanies the executable.

If distribution of executable or object code is made by offering access to copy from a designated place, then offering equivalent access to copy the source code from the same place counts as distribution of the source code, even though third parties are not compelled to copy the source along with the object code.

4. You may not copy, modify, sublicense, or distribute the Program except as expressly provided under this License. Any attempt otherwise to copy, modify, sublicense or distribute the Program is void, and will automatically terminate your rights under this License. However, parties who have received copies, or rights, from you under this License will not have their licenses terminated so long as such parties remain in full compliance.
5. You are not required to accept this License, since you have not signed it. However, nothing else grants you permission to modify or distribute the Program or its derivative works. These actions are prohibited by law if you do not accept this License. Therefore, by modifying or distributing the Program (or any work based on the Program), you indicate your acceptance of this License to do so, and all its terms and conditions for copying, distributing or modifying the Program or works based on it.
6. Each time you redistribute the Program (or any work based on the Program), the recipient automatically receives a license from the original licensor to copy, distribute or modify the Program subject to these terms and conditions. You may not impose any further restrictions on the recipients' exercise of the rights granted herein. You are not responsible for enforcing compliance by third parties to this License.
7. If, as a consequence of a court judgment or allegation of patent infringement or for any other reason (not limited to patent issues), conditions are imposed on you (whether by court order, agreement or otherwise) that contradict the conditions of this License, they do not excuse you from the conditions of this License. If you cannot distribute so as to satisfy simultaneously your obligations under this License and any other pertinent obligations, then as a consequence you may not distribute the Program at all. For example, if a patent license would not permit royalty-free redistribution of the Program by all those who receive copies directly or indirectly through you, then the only way you could satisfy both it and this License would be to refrain entirely from distribution of the Program.

If any portion of this section is held invalid or unenforceable under any particular circumstance, the balance of the section is intended to apply and the section as a whole is intended to apply in other circumstances.

It is not the purpose of this section to induce you to infringe any patents or other property right claims or to contest validity of any such claims; this section has the sole purpose of protecting the integrity of the free software distribution system, which is implemented by public license practices. Many people have made generous contributions to the wide range of software distributed through that system in reliance on consistent application of that system; it is up to the author/donor to decide if he or she is willing to distribute software through any other system and a licensee cannot impose that choice.

This section is intended to make thoroughly clear what is believed to be a consequence of the rest of this License.

8. If the distribution and/or use of the Program is restricted in certain countries either by patents or by copyrighted interfaces, the original copyright holder who places the Program under this License may add an explicit geographical distribution limitation excluding those countries, so that distribution is permitted only in or among countries not thus excluded. In such case, this License incorporates the limitation as if written in the body of this License.
9. The Free Software Foundation may publish revised and/or new versions of the General Public License from time to time. Such new versions will be similar in spirit to the present version, but may differ in detail to address new problems or concerns.

Each version is given a distinguishing version number. If the Program specifies a version number of this License which applies to it and "any later version", you have the option of following the terms and conditions either of that version or of any later version published by the Free Software Foundation. If the Program does not specify a version number of this License, you may choose any version ever published by the Free Software Foundation.

10. If you wish to incorporate parts of the Program into other free programs whose distribution conditions are different, write to the author to ask for permission. For software which is copyrighted by the Free Software Foundation, write to the Free Software Foundation; we sometimes make exceptions for this. Our decision will be guided by the two goals of preserving the free status of all derivatives of our free software and of promoting the sharing and reuse of software generally.

NO WARRANTY

11. BECAUSE THE PROGRAM IS LICENSED FREE OF CHARGE, THERE IS NO WARRANTY FOR THE PROGRAM, TO THE EXTENT PERMITTED BY APPLICABLE LAW. EXCEPT WHEN OTHERWISE STATED IN WRITING THE COPYRIGHT HOLDERS AND/OR OTHER PARTIES PROVIDE THE PROGRAM "AS IS" WITHOUT WARRANTY OF ANY KIND, EITHER EXPRESSED OR IMPLIED, INCLUDING, BUT NOT LIMITED TO, THE IMPLIED WARRANTIES OF MERCHANTABILITY AND FITNESS FOR A PARTICULAR PURPOSE. THE ENTIRE RISK AS TO THE QUALITY AND PERFORMANCE OF THE PROGRAM IS WITH YOU. SHOULD THE PROGRAM PROVE DEFECTIVE, YOU ASSUME THE COST OF ALL NECESSARY SERVICING, REPAIR OR CORRECTION.
12. IN NO EVENT UNLESS REQUIRED BY APPLICABLE LAW OR AGREED TO IN WRITING WILL ANY COPYRIGHT HOLDER, OR ANY OTHER PARTY WHO MAY MODIFY AND/OR REDISTRIBUTE THE PROGRAM AS PERMITTED ABOVE, BE LIABLE TO YOU FOR DAMAGES, INCLUDING ANY GENERAL, SPECIAL, INCIDENTAL OR CONSEQUENTIAL DAMAGES ARISING OUT OF THE USE OR INABILITY TO USE THE PROGRAM (INCLUDING BUT NOT LIMITED TO LOSS OF DATA OR DATA BEING RENDERED INACCURATE OR LOSSES SUSTAINED BY YOU OR THIRD PARTIES OR A FAILURE OF THE PROGRAM TO OPERATE WITH ANY OTHER PROGRAMS), EVEN IF SUCH HOLDER OR OTHER PARTY HAS BEEN ADVISED OF THE POSSIBILITY OF SUCH DAMAGES.

END OF TERMS AND CONDITIONS

Appendix: How to Apply These Terms to Your New Programs

If you develop a new program, and you want it to be of the greatest possible use to the public, the best way to achieve this is to make it free software which everyone can redistribute and change under these terms.

To do so, attach the following notices to the program. It is safest to attach them to the start of each source file to most effectively convey the exclusion of warranty; and each file should have at least the "copyright" line and a pointer to where the full notice is found.

```
<one line to give the program's name and a brief idea of what it does.>
Copyright (C) 19yy <name of author>
```

This program is free software; you can redistribute it and/or modify it under the terms of the GNU General Public License as published by the Free Software Foundation; either version 2 of the License, or (at your option) any later version.

This program is distributed in the hope that it will be useful, but WITHOUT ANY WARRANTY; without even the implied warranty of MERCHANTABILITY or FITNESS FOR A PARTICULAR PURPOSE. See the GNU General Public License for more details.

You should have received a copy of the GNU General Public License along with this program; if not, write to the Free Software Foundation, Inc., 675 Mass Ave, Cambridge, MA 02139, USA.

Also add information on how to contact you by electronic and paper mail.

If the program is interactive, make it output a short notice like this when it starts in an interactive mode:

```
Gnomovision version 69, Copyright (C) 19yy name of author
```

```
Gnomovision comes with ABSOLUTELY NO WARRANTY; for details type `show w`.
```

```
This is free software, and you are welcome to redistribute it under certain conditions; type `show c` for details.
```

The hypothetical commands `show w` and `show c` should show the appropriate parts of the General Public License. Of course, the commands you use may be called something other than `show w` and `show c`; they could even be mouse-clicks or menu items--whatever suits your program.

You should also get your employer (if you work as a programmer) or your school, if any, to sign a "copyright disclaimer" for the program, if necessary. Here is a sample; alter the names:

Yoyodyne, Inc., hereby disclaims all copyright interest in the program `Gnomovision' (which makes passes at compilers) written by James Hacker.

```
<signature of Ty Coon>, 1 April 1989
```

```
Ty Coon, President of Vice
```

This General Public License does not permit incorporating your program into proprietary programs. If your program is a subroutine library, you may consider it more useful to permit linking proprietary applications with the library. If this is what you want to do, use the GNU Library General Public License instead of this License.

3. Busybox, the Linux IR control package and SquashFS

Busybox, the Linux IR control package and SquashFS are subject to the GPL, a copy of which is included at item 2.

4. DirectFB, glibc, libusb-compat, libusb and mtd-utils

DirectFB glibc, libmtp and libusb are subject to the following license:

GNU LESSER GENERAL PUBLIC LICENSE

Version 2.1, February 1999

Copyright (C) 1991, 1999 Free Software Foundation, Inc.

59 Temple Place, Suite 330, Boston, MA 02111-1307 USA

Everyone is permitted to copy and distribute verbatim copies of this license document, but changing it is not allowed.

[This is the first released version of the Lesser GPL. It also counts as the successor of the GNU Library Public License, version 2, hence the version number 2.1.]

Preamble

The licenses for most software are designed to take away your freedom to share and change it. By contrast, the GNU General Public Licenses are intended to guarantee your freedom to share and change free software--to make sure the software is free for all its users.

This license, the Lesser General Public License, applies to some specially designated software packages--typically libraries--of the Free Software Foundation and other authors who decide to use it. You can use it too, but we suggest you first think carefully about whether this license or the ordinary General Public License is the better strategy to use in any particular case, based on the explanations below.

When we speak of free software, we are referring to freedom of use, not price. Our General Public Licenses are designed to make sure that you have the freedom to distribute copies of free software (and charge for this service if you wish); that you receive source code or can get it if you want it; that you can change the software and use pieces of it in new free programs; and that you are informed that you can do these things.

To protect your rights, we need to make restrictions that forbid distributors to deny you these rights or to ask you to surrender these rights. These restrictions translate to certain responsibilities for you if you distribute copies of the library or if you modify it.

For example, if you distribute copies of the library, whether gratis or for a fee, you must give the recipients all the rights that we gave you. You must make sure that they, too, receive or can get the source code. If you link other code with the library, you must provide complete object files to the recipients, so that they can relink them with the library after making changes to the library and recompiling it. And you must show them these terms so they know their rights.

We protect your rights with a two-step method: (1) we copyright the library, and (2) we offer you this license, which gives you legal permission to copy, distribute and/or modify the library.

To protect each distributor, we want to make it very clear that there is no warranty for the free library. Also, if the library is modified by someone else and passed on, the recipients should know that what they have is not the original version, so that the original author's reputation will not be affected by problems that might be introduced by others.

Finally, software patents pose a constant threat to the existence of any free program. We wish to make sure that a company cannot effectively restrict the users of a free program by obtaining a restrictive license from a patent holder. Therefore, we insist that any patent license obtained for a version of the library must be consistent with the full freedom of use specified in this license.

Most GNU software, including some libraries, is covered by the ordinary GNU General Public License. This license, the GNU Lesser General Public License, applies to certain designated libraries, and is quite different from the ordinary General Public License. We use this license for certain libraries in order to permit linking those libraries into non-free programs.

When a program is linked with a library, whether statically or using a shared library, the combination of the two is legally speaking a combined work, a derivative of the original library. The ordinary General Public License therefore permits such linking only if the entire combination fits its criteria of freedom. The Lesser General Public License permits more lax criteria for linking other code with the library.

We call this license the "Lesser" General Public License because it does Less to protect the user's freedom than the ordinary General Public License. It also provides other free software developers Less of an advantage over competing non-free programs. These disadvantages are the reason we use the ordinary General Public License for many libraries. However, the Lesser license provides advantages in certain special circumstances.

For example, on rare occasions, there may be a special need to encourage the widest possible use of a certain library, so that it becomes a de-facto standard. To achieve this, non-free programs must be allowed to use the library. A more frequent case is that a free library does the same job as widely used non-free libraries. In this case, there is little to gain by limiting the free library to free software only, so we use the Lesser General Public License.

In other cases, permission to use a particular library in non-free programs enables a greater number of people to use a large body of free software. For example, permission to use the GNU C Library in non-free programs enables many more people to use the whole GNU operating system, as well as its variant, the GNU/Linux operating system.

Although the Lesser General Public License is Less protective of the users' freedom, it does ensure that the user of a program that is linked with the Library has the freedom and the wherewithal to run that program using a modified version of the Library.

The precise terms and conditions for copying, distribution and modification follow. Pay close attention to the difference between a "work based on the library" and a "work that uses the library". The former contains code derived from the library, whereas the latter must be combined with the library in order to run.

GNU LESSER GENERAL PUBLIC LICENSE

TERMS AND CONDITIONS FOR COPYING, DISTRIBUTION AND MODIFICATION

0. This License Agreement applies to any software library or other program which contains a notice placed by the copyright holder or other authorized party saying it may be distributed under the terms of this Lesser General Public License (also called "this License").

Each licensee is addressed as "you".

A "library" means a collection of software functions and/or data prepared so as to be conveniently linked with application programs (which use some of those functions and data) to form executables.

The "Library", below, refers to any such software library or work which has been distributed under these terms. A "work based on the Library" means either the Library or any derivative work under copyright law: that is to say, a work containing the Library or a portion of it, either verbatim or with modifications and/or translated straightforwardly into another language. (Hereinafter, translation is included without limitation in the term "modification".)

"Source code" for a work means the preferred form of the work for making modifications to it. For a library, complete source code means all the source code for all modules it contains, plus any associated interface definition files, plus the scripts used to control compilation and installation of the library.

Activities other than copying, distribution and modification are not covered by this License; they are outside its scope. The act of running a program using the Library is not restricted, and output from such a program is covered only if its contents constitute a work based on the Library (independent of the use of the Library in a tool for writing it). Whether that is true depends on what the Library does and what the program that uses the Library does.

1. You may copy and distribute verbatim copies of the Library's complete source code as you receive it, in any medium, provided that you conspicuously and appropriately publish on each copy an appropriate copyright notice and disclaimer of warranty; keep intact all the notices that refer to this License and to the absence of any warranty; and distribute a copy of this License along with the Library.

You may charge a fee for the physical act of transferring a copy, and you may at your option offer warranty protection in exchange for a fee.

2. You may modify your copy or copies of the Library or any portion of it, thus forming a work based on the Library, and copy and distribute such modifications or work under the terms of Section 1 above, provided that you also meet all of these conditions:
 - a) The modified work must itself be a software library.
 - b) You must cause the files modified to carry prominent notices stating that you changed the files and the date of any change.
 - c) You must cause the whole of the work to be licensed at no charge to all third parties under the terms of this License.
 - d) If a facility in the modified Library refers to a function or a table of data to be supplied by an application program that uses the facility, other than as an argument passed when the facility is invoked, then you must make a good faith effort to ensure that, in the event an application does not supply such function or table, the facility still operates, and performs whatever part of its purpose remains meaningful.
(For example, a function in a library to compute square roots has a purpose that is entirely well-defined independent of the application. Therefore, Subsection 2d requires that any application-supplied function or table used by this function must be optional: if the application does not supply it, the square root function must still compute square roots.)

These requirements apply to the modified work as a whole. If identifiable sections of that work are not derived from the Library, and can be reasonably considered independent and separate works in themselves, then this License, and its terms, do not apply to those sections when you distribute them as separate works. But when you distribute the same sections as part of a whole which is a work based on the Library, the distribution of the whole must be on the terms of this License, whose permissions for other licensees extend to the entire whole, and thus to each and every part regardless of who wrote it.

Thus, it is not the intent of this section to claim rights or contest your rights to work written entirely by you; rather, the intent is to exercise the right to control the distribution of derivative or collective works based on the Library.

In addition, mere aggregation of another work not based on the Library with the Library (or with a work based on the Library) on a volume of a storage or distribution medium does not bring the other work under the scope of this License.

3. You may opt to apply the terms of the ordinary GNU General Public License instead of this License to a given copy of the Library. To do this, you must alter all the notices that refer to this License, so that they refer to the ordinary GNU General Public License, version 2, instead of to this License. (If a newer version than version 2 of the ordinary GNU General Public License has appeared, then you can specify that version instead if you wish.) Do not make any other change in these notices.

Once this change is made in a given copy, it is irreversible for that copy, so the ordinary GNU General Public License applies to all subsequent copies and derivative works made from that copy.

This option is useful when you wish to copy part of the code of the Library into a program that is not a library.

4. You may copy and distribute the Library (or a portion or derivative of it, under Section 2) in object code or executable form under the terms of Sections 1 and 2 above provided that you accompany it with the complete corresponding machine-readable source code, which must be distributed under the terms of Sections 1 and 2 above on a medium customarily used for software interchange.

If distribution of object code is made by offering access to copy from a designated place, then offering equivalent access to copy the source code from the same place satisfies the requirement to distribute the source code, even though third parties are not compelled to copy the source along with the object code.

5. A program that contains no derivative of any portion of the Library, but is designed to work with the Library by being compiled or linked with it, is called a "work that uses the Library". Such a work, in isolation, is not a derivative work of the Library, and therefore falls outside the scope of this License.

However, linking a "work that uses the Library" with the Library creates an executable that is a derivative of the Library (because it contains portions of the Library), rather than a "work that uses the library". The executable is therefore covered by this License.

Section 6 states terms for distribution of such executables.

When a “work that uses the Library” uses material from a header file that is part of the Library, the object code for the work may be a derivative work of the Library even though the source code is not.

Whether this is true is especially significant if the work can be linked without the Library, or if the work is itself a library. The threshold for this to be true is not precisely defined by law.

If such an object file uses only numerical parameters, data structure layouts and accessors, and small macros and small inline functions (ten lines or less in length), then the use of the object file is unrestricted, regardless of whether it is legally a derivative work. (Executables containing this object code plus portions of the Library will still fall under Section 6.)

Otherwise, if the work is a derivative of the Library, you may distribute the object code for the work under the terms of Section 6.

Any executables containing that work also fall under Section 6, whether or not they are linked directly with the Library itself.

6. As an exception to the Sections above, you may also combine or link a “work that uses the Library” with the Library to produce a work containing portions of the Library, and distribute that work under terms of your choice, provided that the terms permit modification of the work for the customer's own use and reverse engineering for debugging such modifications.

You must give prominent notice with each copy of the work that the Library is used in it and that the Library and its use are covered by this License. You must supply a copy of this License. If the work during execution displays copyright notices, you must include the copyright notice for the Library among them, as well as a reference directing the user to the copy of this License. Also, you must do one of these things:

- a) Accompany the work with the complete corresponding machine-readable source code for the Library including whatever changes were used in the work (which must be distributed under Sections 1 and 2 above); and, if the work is an executable linked with the Library, with the complete machine-readable “work that uses the Library”, as object code and/or source code, so that the user can modify the Library and then relink to produce a modified executable containing the modified Library. (It is understood that the user who changes the contents of definitions files in the Library will not necessarily be able to recompile the application to use the modified definitions.)
- b) Use a suitable shared library mechanism for linking with the Library. A suitable mechanism is one that (1) uses at run time a copy of the library already present on the user's computer system, rather than copying library functions into the executable, and (2) will operate properly with a modified version of the library, if the user installs one, as long as the modified version is interface-compatible with the version that the work was made with.
- c) Accompany the work with a written offer, valid for at least three years, to give the same user the materials specified in Subsection 6a, above, for a charge no more than the cost of performing this distribution.
- d) If distribution of the work is made by offering access to copy from a designated place, offer equivalent access to copy the above specified materials from the same place.
- e) Verify that the user has already received a copy of these materials or that you have already sent this user a copy.

For an executable, the required form of the “work that uses the library” must include any data and utility programs needed for reproducing the executable from it. However, as a special exception, the materials to be distributed need not include anything that is normally distributed (in either source or binary form) with the major components (compiler, kernel, and so on) of the operating system on which the executable runs, unless that component itself accompanies the executable.

It may happen that this requirement contradicts the license restrictions of other proprietary libraries that do not normally accompany the operating system. Such a contradiction means you cannot use both them and the Library together in an executable that you distribute.

7. You may place library facilities that are a work based on the Library side-by-side in a single library together with other library facilities not covered by this License, and distribute such a combined library, provided that the separate distribution of the work based on the Library and of the other library facilities is otherwise permitted, and provided that you do these two things:
 - a) Accompany the combined library with a copy of the same work based on the Library, uncombined with any other library facilities. This must be distributed under the terms of the Sections above.
 - b) Give prominent notice with the combined library of the fact that part of it is a work based on the Library, and explaining where to find the accompanying uncombined form of the same work.

8. You may not copy, modify, sublicense, link with, or distribute the Library except as expressly provided under this License. Any attempt otherwise to copy, modify, sublicense, link with, or distribute the Library is void, and will automatically terminate your rights under this License. However, parties who have received copies, or rights, from you under this License will not have their licenses terminated so long as such parties remain in full compliance.
9. You are not required to accept this License, since you have not signed it. However, nothing else grants you permission to modify or distribute the Library or its derivative works. These actions are prohibited by law if you do not accept this License. Therefore, by modifying or distributing the Library (or any work based on the Library), you indicate your acceptance of this License to do so, and all its terms and conditions for copying, distributing or modifying the Library or works based on it.
10. Each time you redistribute the Library (or any work based on the Library), the recipient automatically receives a license from the original licensor to copy, distribute, link with or modify the Library subject to these terms and conditions. You may not impose any further restrictions on the recipients' exercise of the rights granted herein.

You are not responsible for enforcing compliance by third parties with this License.

11. If, as a consequence of a court judgment or allegation of patent infringement or for any other reason (not limited to patent issues), conditions are imposed on you (whether by court order, agreement or otherwise) that contradict the conditions of this License, they do not excuse you from the conditions of this License. If you cannot distribute so as to satisfy simultaneously your obligations under this License and any other pertinent obligations, then as a consequence you may not distribute the Library at all. For example, if a patent license would not permit royalty-free redistribution of the Library by all those who receive copies directly or indirectly through you, then the only way you could satisfy both it and this License would be to refrain entirely from distribution of the Library.

If any portion of this section is held invalid or unenforceable under any particular circumstance, the balance of the section is intended to apply, and the section as a whole is intended to apply in other circumstances.

It is not the purpose of this section to induce you to infringe any patents or other property right claims or to contest validity of any such claims; this section has the sole purpose of protecting the integrity of the free software distribution system which is implemented by public license practices. Many people have made generous contributions to the wide range of software distributed through that system in reliance on consistent application of that system; it is up to the author/donor to decide if he or she is willing to distribute software through any other system and a licensee cannot impose that choice.

This section is intended to make thoroughly clear what is believed to be a consequence of the rest of this License.

12. If the distribution and/or use of the Library is restricted in certain countries either by patents or by copyrighted interfaces, the original copyright holder who places the Library under this License may add an explicit geographical distribution limitation excluding those countries, so that distribution is permitted only in or among countries not thus excluded. In such case, this License incorporates the limitation as if written in the body of this License.
13. The Free Software Foundation may publish revised and/or new versions of the Lesser General Public License from time to time. Such new versions will be similar in spirit to the present version, but may differ in detail to address new problems or concerns.

Each version is given a distinguishing version number. If the Library specifies a version number of this License which applies to it and "any later version", you have the option of following the terms and conditions either of that version or of any later version published by the Free Software Foundation. If the Library does not specify a license version number, you may choose any version ever published by the Free Software Foundation.

14. If you wish to incorporate parts of the Library into other free programs whose distribution conditions are incompatible with these, write to the author to ask for permission. For software which is copyrighted by the Free Software Foundation, write to the Free Software Foundation; we sometimes make exceptions for this. Our decision will be guided by the two goals of preserving the free status of all derivatives of our free software and of promoting the sharing and reuse of software generally.

NO WARRANTY

15. BECAUSE THE LIBRARY IS LICENSED FREE OF CHARGE, THERE IS NO WARRANTY FOR THE LIBRARY, TO THE EXTENT PERMITTED BY APPLICABLE LAW. EXCEPT WHEN OTHERWISE STATED IN WRITING THE COPYRIGHT HOLDERS AND/OR OTHER PARTIES PROVIDE THE LIBRARY "AS IS" WITHOUT WARRANTY OF ANY KIND, EITHER EXPRESSED OR IMPLIED, INCLUDING, BUT NOT LIMITED TO, THE IMPLIED WARRANTIES OF MERCHANTABILITY AND FITNESS FOR A PARTICULAR PURPOSE. THE ENTIRE RISK AS TO THE QUALITY AND PERFORMANCE OF THE LIBRARY IS WITH

YOU. SHOULD THE LIBRARY PROVE DEFECTIVE, YOU ASSUME THE COST OF ALL NECESSARY SERVICING, REPAIR OR CORRECTION.

16. IN NO EVENT UNLESS REQUIRED BY APPLICABLE LAW OR AGREED TO IN WRITING WILL ANY COPYRIGHT HOLDER, OR ANY OTHER PARTY WHO MAY MODIFY AND/OR REDISTRIBUTE THE LIBRARY AS PERMITTED ABOVE, BE LIABLE TO YOU FOR DAMAGES, INCLUDING ANY GENERAL, SPECIAL, INCIDENTAL OR CONSEQUENTIAL DAMAGES ARISING OUT OF THE USE OR INABILITY TO USE THE LIBRARY (INCLUDING BUT NOT LIMITED TO LOSS OF DATA OR DATA BEING RENDERED INACCURATE OR LOSSES SUSTAINED BY YOU OR THIRD PARTIES OR A FAILURE OF THE LIBRARY TO OPERATE WITH ANY OTHER SOFTWARE), EVEN IF SUCH HOLDER OR OTHER PARTY HAS BEEN ADVISED OF THE POSSIBILITY OF SUCH DAMAGES.

END OF TERMS AND CONDITIONS

How to Apply These Terms to Your New Libraries

If you develop a new library, and you want it to be of the greatest possible use to the public, we recommend making it free software that everyone can redistribute and change. You can do so by permitting redistribution under these terms (or, alternatively, under the terms of the ordinary General Public License).

To apply these terms, attach the following notices to the library. It is safest to attach them to the start of each source file to most effectively convey the exclusion of warranty; and each file should have at least the "copyright" line and a pointer to where the full notice is found.

<one line to give the library's name and a brief idea of what it does.>

Copyright (C) <year> <name of author>

This library is free software; you can redistribute it and/or modify it under the terms of the GNU Lesser General Public License as published by the Free Software Foundation; either version 2.1 of the License, or (at your option) any later version.

This library is distributed in the hope that it will be useful, but WITHOUT ANY WARRANTY; without even the implied warranty of MERCHANTABILITY or FITNESS FOR A PARTICULAR PURPOSE. See the GNU Lesser General Public License for more details.

You should have received a copy of the GNU Lesser General Public License along with this library; if not, write to the Free Software Foundation, Inc., 59 Temple Place, Suite 330, Boston, MA 02111-1307 USA

Also add information on how to contact you by electronic and paper mail.

You should also get your employer (if you work as a programmer) or your school, if any, to sign a "copyright disclaimer" for the library, if necessary. Here is a sample; alter the names:

Yoyodyne, Inc., hereby disclaims all copyright interest in the library 'Frob' (a library for tweaking knobs) written by James Random Hacker.

<signature of Ty Coon>, 1 April 1990

Ty Coon, President of Vice

That's all there is to it!

5. IJG: JPEG software decoder

The authors make NO WARRANTY or representation, either express or implied, with respect to this software, its quality, accuracy, merchantability, or fitness for a particular purpose. This software is provided "AS IS", and you, its user, assume the entire risk as to its quality and accuracy.

This software is copyright (C) 1991-1998, Thomas G. Lane.

All Rights Reserved except as specified below.

Permission is hereby granted to use, copy, modify, and distribute this software (or portions thereof) for any purpose, without fee, subject to these conditions:

- (1) If any part of the source code for this software is distributed, then this README file must be included, with this copyright and no-warranty notice unaltered; and any additions, deletions, or changes to the original files must be clearly indicated in accompanying documentation.
- (2) If only executable code is distributed, then the accompanying documentation must state that "this software is based in part on the work of the Independent JPEG Group".
- (3) Permission for use of this software is granted only if the user accepts full responsibility for any undesirable consequences; the authors accept NO LIABILITY for damages of any kind.

6. WPA Supplicant

Copyright (c) 2003-2009, Jouni Malinen <j@w1.fi> and contributors
All Rights Reserved.

Redistribution and use in source and binary forms, with or without modification, are permitted provided that the following conditions are met:

1. Redistributions of source code must retain the above copyright notice, this list of conditions and the following disclaimer.
2. Redistributions in binary form must reproduce the above copyright notice, this list of conditions and the following disclaimer in the documentation and/or other materials provided with the distribution.
3. Neither the name(s) of the above-listed copyright holder(s) nor the names of its contributors may be used to endorse or promote products derived from this software without specific prior written permission.

THIS SOFTWARE IS PROVIDED BY THE COPYRIGHT HOLDERS AND CONTRIBUTORS "AS IS" AND ANY EXPRESS OR IMPLIED WARRANTIES, INCLUDING, BUT NOT LIMITED TO, THE IMPLIED WARRANTIES OF MERCHANTABILITY AND FITNESS FOR A PARTICULAR PURPOSE ARE DISCLAIMED. IN NO EVENT SHALL THE COPYRIGHT OWNER OR CONTRIBUTORS BE LIABLE FOR ANY DIRECT, INDIRECT, INCIDENTAL, SPECIAL, EXEMPLARY, OR CONSEQUENTIAL DAMAGES (INCLUDING, BUT NOT LIMITED TO, PROCUREMENT OF SUBSTITUTE GOODS OR SERVICES; LOSS OF USE, DATA, OR PROFITS; OR BUSINESS INTERRUPTION) HOWEVER CAUSED AND ON ANY THEORY OF LIABILITY, WHETHER IN CONTRACT, STRICT LIABILITY, OR TORT (INCLUDING NEGLIGENCE OR OTHERWISE) ARISING IN ANY WAY OUT OF THE USE OF THIS SOFTWARE, EVEN IF ADVISED OF THE POSSIBILITY OF SUCH DAMAGE.

7. Unicode Bidirectional Algorithm

For the general privacy policy governing access to this site, see the Unicode Privacy Policy. For trademark usage, see the Unicode Consortium® Trademarks and Logo Policy.

Notice to End User: Terms of Use

Carefully read the following legal agreement ("Agreement"). Use or copying of the software and/or codes provided with this agreement (The "Software") constitutes your acceptance of these terms

Unicode Copyright.

Copyright © 1991-2009 Unicode, Inc. All rights reserved.

Certain documents and files on this website contain a legend indicating that "Modification is permitted." Any person is hereby authorized, without fee, to modify such documents and files to create derivative works conforming to the Unicode® Standard, subject to Terms and Conditions herein.

Any person is hereby authorized, without fee, to view, use, reproduce, and distribute all documents and files solely for informational purposes in the creation of products supporting the Unicode Standard, subject to the Terms and Conditions herein.

Further specifications of rights and restrictions pertaining to the use of the particular set of data files known as the "Unicode Character Database" can be found in Exhibit 1.

Each version of the Unicode Standard has further specifications of rights and restrictions of use. For the book editions, these are found on the back of the title page. For the online edition, certain files (such as the PDF files for book chapters and code charts) carry specific restrictions. All other files are covered under these general Terms of Use. To request a permission to reproduce any part of the Unicode Standard, please contact the Unicode Consortium.

No license is granted to "mirror" the Unicode website where a fee is charged for access to the "mirror" site.

Modification is not permitted with respect to this document. All copies of this document must be verbatim.

Restricted Rights Legend. Any technical data or software which is licensed to the United States of America, its agencies and/or instrumentalities under this Agreement is commercial technical data or commercial computer software developed exclusively at private expense as defined in FAR 2.101, or DFARS 252.227-7014 (June 1995), as applicable. For technical data, use, duplication, or disclosure by the Government is subject to restrictions as set forth in DFARS 202.227-7015 Technical Data, Commercial and Items (Nov 1995) and this Agreement. For Software, in accordance with FAR 12-212 or DFARS 227-7202, as applicable, use, duplication or disclosure by the Government is subject to the restrictions set forth in this Agreement.

Warranties and Disclaimers.

This publication and/or website may include technical or typographical errors or other inaccuracies. Changes are periodically added to the information herein; these changes will be incorporated in new editions of

the publication and/or website. Unicode may make improvements and/or changes in the product(s) and/or program(s) described in this publication and/or website at any time.

If this file has been purchased on magnetic or optical media from Unicode, Inc. the sole and exclusive remedy for any claim will be exchange of the defective media within ninety (90) days of original purchase.

EXCEPT AS PROVIDED IN SECTION C.2, THIS PUBLICATION AND/OR SOFTWARE IS PROVIDED "AS IS" WITHOUT WARRANTY OF ANY KIND EITHER EXPRESS, IMPLIED, OR STATUTORY, INCLUDING, BUT NOT LIMITED TO, ANY WARRANTIES OF MERCHANTABILITY, FITNESS FOR A PARTICULAR PURPOSE, OR NON-INFRINGEMENT. UNICODE AND ITS LICENSORS ASSUME NO RESPONSIBILITY FOR ERRORS OR OMISSIONS IN THIS PUBLICATION AND/OR SOFTWARE OR OTHER DOCUMENTS WHICH ARE REFERENCED BY OR LINKED TO THIS PUBLICATION OR THE UNICODE WEBSITE.

Waiver of Damages. In no event shall Unicode or its licensors be liable for any special, incidental, indirect or consequential damages of any kind, or any damages whatsoever, whether or not Unicode was advised of the possibility of the damage, including, without limitation, those resulting from the following: loss of use, data or profits, in connection with the use, modification or distribution of this information or its derivatives.

Trademarks.

Unicode and the Unicode logo are registered trademarks of Unicode, Inc.

This site contains product names and corporate names of other companies. All product names and company names and logos mentioned herein are the trademarks or registered trademarks of their respective owners. Other products and corporate names mentioned herein which are trademarks of a third party are used only for explanation and for the owners' benefit and with no intent to infringe.

Use of third party products or information referred to herein is at the user's risk.

Miscellaneous.

Jurisdiction and Venue. This server is operated from a location in the State of California, United States of America. Unicode makes no representation that the materials are appropriate for use in other locations. If you access this server from other locations, you are responsible for compliance with local laws. This Agreement, all use of this site and any claims and damages resulting from use of this site are governed solely by the laws of the State of California without regard to any principles which would apply the laws of a different jurisdiction. The user agrees that any disputes regarding this site shall be resolved solely in the courts located in Santa Clara County, California. The user agrees said courts have personal jurisdiction and agree to waive any right to transfer the dispute to any other forum.

Modification by Unicode Unicode shall have the right to modify this Agreement at any time by posting it to this site. The user may not assign any part of this Agreement without Unicode's prior written consent.

Taxes. The user agrees to pay any taxes arising from access to this website or use of the information herein, except for those based on Unicode's net income.

Severability. If any provision of this Agreement is declared invalid or unenforceable, the remaining provisions of this Agreement shall remain in effect.

Entire Agreement. This Agreement constitutes the entire agreement between the parties.

EXHIBIT 1

UNICODE, INC. LICENSE AGREEMENT - DATA FILES AND SOFTWARE

Unicode Data Files include all data files under the directories <http://www.unicode.org/Public/>, <http://www.unicode.org/reports/>, and <http://www.unicode.org/cldr/data/>. Unicode Software includes any source code published in the Unicode Standard or under the directories <http://www.unicode.org/Public/>, <http://www.unicode.org/reports/>, and <http://www.unicode.org/cldr/data/>.

NOTICE TO USER: Carefully read the following legal agreement. BY DOWNLOADING, INSTALLING, COPYING OR OTHERWISE USING UNICODE INC.'S DATA FILES ("DATA FILES"), AND/OR SOFTWARE ("SOFTWARE"), YOU UNEQUIVOCALLY ACCEPT, AND AGREE TO BE BOUND BY, ALL OF THE TERMS AND CONDITIONS OF THIS AGREEMENT. IF YOU DO NOT AGREE, DO NOT DOWNLOAD, INSTALL, COPY, DISTRIBUTE OR USE THE DATA FILES OR SOFTWARE.

COPYRIGHT AND PERMISSION NOTICE

Copyright © 1991-2009 Unicode, Inc. All rights reserved. Distributed under the Terms of Use in <http://www.unicode.org/copyright.html>.

Permission is hereby granted, free of charge, to any person obtaining a copy of the Unicode data files and any associated documentation (the "Data Files") or Unicode software and any associated documentation (the "Software") to deal in the Data Files or Software without restriction, including without limitation the rights to use, copy, modify, merge, publish, distribute, and/or sell copies of the Data Files or Software, and to permit persons to whom the Data Files or Software are furnished to do so, provided that (a) the above copyright notice(s) and this permission notice appear with all copies of the Data Files or Software, (b) both the above

copyright notice(s) and this permission notice appear in associated documentation, and (c) there is clear notice in each modified Data File or in the Software as well as in the documentation associated with the Data File(s) or Software that the data or software has been modified.

THE DATA FILES AND SOFTWARE ARE PROVIDED "AS IS", WITHOUT WARRANTY OF ANY KIND, EXPRESS OR IMPLIED, INCLUDING BUT NOT LIMITED TO THE WARRANTIES OF MERCHANTABILITY, FITNESS FOR A PARTICULAR PURPOSE AND NONINFRINGEMENT OF THIRD PARTY RIGHTS. IN NO EVENT SHALL THE COPYRIGHT HOLDER OR HOLDERS INCLUDED IN THIS NOTICE BE LIABLE FOR ANY CLAIM, OR ANY SPECIAL INDIRECT OR CONSEQUENTIAL DAMAGES, OR ANY DAMAGES WHATSOEVER RESULTING FROM LOSS OF USE, DATA OR PROFITS, WHETHER IN AN ACTION OF CONTRACT, NEGLIGENCE OR OTHER TORTIOUS ACTION, ARISING OUT OF OR IN CONNECTION WITH THE USE OR PERFORMANCE OF THE DATA FILES OR SOFTWARE.

Except as contained in this notice, the name of a copyright holder shall not be used in advertising or otherwise to promote the sale, use or other dealings in these Data Files or Software without prior written authorization of the copyright holder.

Unicode and the Unicode logo are trademarks of Unicode, Inc., and may be registered in some jurisdictions. All other trademarks and registered trademarks mentioned herein are the property of their respective owners.

8. OpenSSL.

Open SSL is an Open Source toolkit implementing the Secure Sockets Layer (SSL v2/v3) and Transport Layer Security (TLS v1) protocols as well as a full-strength general purpose cryptography library.

See <http://www.openssl.org/>, and in particular <http://www.openssl.org/source/license.html>.

The license conditions are copied below.

The OpenSSL toolkit stays under a dual license, i.e. both the conditions of the OpenSSL License and the original SSLeay license apply to the toolkit.

See below for the actual license texts. Actually both licenses are BSD-style

Open Source licenses. In case of any license issues related to OpenSSL, please contact openssl-core@openssl.org.

OpenSSL License

```
/* =====
```

```
* Copyright (c) 1998-2008 The OpenSSL Project. All rights reserved.
```

```
*
```

```
* Redistribution and use in source and binary forms, with or without  
* modification, are permitted provided that the following conditions  
* are met:
```

```
*
```

```
* 1. Redistributions of source code must retain the above copyright  
* notice, this list of conditions and the following disclaimer.
```

```
*
```

```
* 2. Redistributions in binary form must reproduce the above copyright  
* notice, this list of conditions and the following disclaimer in  
* the documentation and/or other materials provided with the  
* distribution.
```

```
*
```

```
* 3. All advertising materials mentioning features or use of this  
* software must display the following acknowledgment:  
* "This product includes software developed by the OpenSSL Project  
* for use in the OpenSSL Toolkit. (http://www.openssl.org/)"
```

```
*
```

```
* 4. The names "OpenSSL Toolkit" and "OpenSSL Project" must not be used to  
* endorse or promote products derived from this software without  
* prior written permission. For written permission, please contact  
* openssl-core@openssl.org.
```

```
*
```

```
* 5. Products derived from this software may not be called "OpenSSL"
```

```

* nor may "OpenSSL" appear in their names without prior written
* permission of the OpenSSL Project.
*
* 6. Redistributions of any form whatsoever must retain the following
* acknowledgment:
* "This product includes software developed by the OpenSSL Project
* for use in the OpenSSL Toolkit (http://www.openssl.org/)"
*
* THIS SOFTWARE IS PROVIDED BY THE OpenSSL PROJECT "AS IS" AND ANY
* EXPRESSED OR IMPLIED WARRANTIES, INCLUDING, BUT NOT LIMITED TO, THE
* IMPLIED WARRANTIES OF MERCHANTABILITY AND FITNESS FOR A PARTICULAR
* PURPOSE ARE DISCLAIMED. IN NO EVENT SHALL THE OpenSSL PROJECT OR
* ITS CONTRIBUTORS BE LIABLE FOR ANY DIRECT, INDIRECT, INCIDENTAL,
* SPECIAL, EXEMPLARY, OR CONSEQUENTIAL DAMAGES (INCLUDING, BUT
* NOT LIMITED TO, PROCUREMENT OF SUBSTITUTE GOODS OR SERVICES;
* LOSS OF USE, DATA, OR PROFITS; OR BUSINESS INTERRUPTION)
* HOWEVER CAUSED AND ON ANY THEORY OF LIABILITY, WHETHER IN
* CONTRACT, STRICT LIABILITY, OR TORT (INCLUDING NEGLIGENCE OR
* OTHERWISE) ARISING IN ANY WAY OUT OF THE USE OF THIS SOFTWARE,
* EVEN IF ADVISED OF THE POSSIBILITY OF SUCH DAMAGE.
* =====
*
* This product includes cryptographic software written by Eric Young
* (eay@cryptsoft.com). This product includes software written by Tim
* Hudson (tjh@cryptsoft.com).
*
*/

```

Original SSLeay License

```

/* Copyright (C) 1995-1998 Eric Young (eay@cryptsoft.com)
* All rights reserved.
*
* This package is an SSL implementation written
* by Eric Young (eay@cryptsoft.com).
* The implementation was written so as to conform with Netscapes SSL.
*
* This library is free for commercial and non-commercial use as long as
* the following conditions are aheared to. The following conditions
* apply to all code found in this distribution, be it the RC4, RSA,
* lhash, DES, etc., code; not just the SSL code. The SSL documentation
* included with this distribution is covered by the same copyright terms
* except that the holder is Tim Hudson (tjh@cryptsoft.com).
*
* Copyright remains Eric Young's, and as such any Copyright notices in
* the code are not to be removed.
* If this package is used in a product, Eric Young should be given attribution
* as the author of the parts of the library used.
* This can be in the form of a textual message at program startup or
* in documentation (online or textual) provided with the package.
*
* Redistribution and use in source and binary forms, with or without
* modification, are permitted provided that the following conditions
* are met:
* 1. Redistributions of source code must retain the copyright
* notice, this list of conditions and the following disclaimer.
* 2. Redistributions in binary form must reproduce the above copyright
* notice, this list of conditions and the following disclaimer in the
* documentation and/or other materials provided with the distribution.
* 3. All advertising materials mentioning features or use of this software
* must display the following acknowledgement:

```



```

* "This product includes cryptographic software written by
* Eric Young (eay@cryptsoft.com)"
* The word 'cryptographic' can be left out if the rouines from the library
* being used are not cryptographic related :-).
* 4. If you include any Windows specific code (or a derivative thereof) from
* the apps directory (application code) you must include an acknowledgement:
* "This product includes software written by Tim Hudson (tjh@cryptsoft.com)"
*
* THIS SOFTWARE IS PROVIDED BY ERIC YOUNG "AS IS" AND ANY EXPRESS OR
* IMPLIED WARRANTIES, INCLUDING, BUT NOT LIMITED TO, THE IMPLIED
* WARRANTIES OF MERCHANTABILITY AND FITNESS FOR A PARTICULAR
* PURPOSE ARE DISCLAIMED. IN NO EVENT SHALL THE AUTHOR OR
* CONTRIBUTORS BE LIABLE FOR ANY DIRECT, INDIRECT, INCIDENTAL,
* SPECIAL, EXEMPLARY, OR CONSEQUENTIAL DAMAGES (INCLUDING, BUT
* NOT LIMITED TO, PROCUREMENT OF SUBSTITUTE GOODS OR SERVICES; LOSS
* OF USE, DATA, OR PROFITS; OR BUSINESS INTERRUPTION) HOWEVER
* CAUSED AND ON ANY THEORY OF LIABILITY, WHETHER IN CONTRACT,
* STRICT LIABILITY, OR TORT (INCLUDING NEGLIGENCE OR OTHERWISE)
* ARISING IN ANY WAY OUT OF THE USE OF THIS SOFTWARE, EVEN IF ADVISED
* OF THE POSSIBILITY OF SUCH DAMAGE.
*
* The licence and distribution terms for any publically available version or
* derivative of this code cannot be changed. i.e. this code cannot simply be
* copied and put under another distribution licence
* [including the GNU Public Licence.]
*/

```

9. Zlib general purpose compression library

See <http://www.zlib.net/>, and in particular http://www.zlib.net/zlib_license.html.

```

/* zlib.h -- interface of the 'zlib' general purpose compression library version 1.2.3, July 18th, 2005

```

```

Copyright (C) 1995-2005 Jean-loup Gailly and Mark Adler

```

This software is provided 'as-is', without any express or implied warranty. In no event will the authors be held liable for any damages arising from the use of this software.

Permission is granted to anyone to use this software for any purpose, including commercial applications, and to alter it and redistribute it freely, subject to the following restrictions:

1. The origin of this software must not be misrepresented; you must not claim that you wrote the original software. If you use this software in a product, an acknowledgment in the product documentation would be appreciated but is not required.
2. Altered source versions must be plainly marked as such, and must not be misrepresented as being the original software.
3. This notice may not be removed or altered from any source distribution.

```

Jean-loup Gailly jloup@gzip.org
Mark Adler madler@alumni.caltech.edu

```

```

*/

```

10. cURL

COPYRIGHT AND PERMISSION NOTICE

Copyright (c) 1996 - 2009, Daniel Stenberg, <daniel@haxx.se>.

All rights reserved.

Permission to use, copy, modify, and distribute this software for any purpose with or without fee is hereby granted, provided that the above copyright notice and this permission notice appear in all copies.

THE SOFTWARE IS PROVIDED "AS IS", WITHOUT WARRANTY OF ANY KIND, EXPRESS OR IMPLIED, INCLUDING BUT NOT LIMITED TO THE WARRANTIES OF MERCHANTABILITY, FITNESS FOR A PARTICULAR PURPOSE AND NONINFRINGEMENT OF THIRD PARTY RIGHTS. IN NO EVENT SHALL THE AUTHORS OR COPYRIGHT HOLDERS BE LIABLE FOR ANY CLAIM, DAMAGES OR OTHER

LIABILITY, WHETHER IN AN ACTION OF CONTRACT, TORT OR OTHERWISE, ARISING FROM, OUT OF OR IN CONNECTION WITH THE SOFTWARE OR THE USE OR OTHER DEALINGS IN THE SOFTWARE.

Except as contained in this notice, the name of a copyright holder shall not be used in advertising or otherwise to promote the sale, use or other dealings in this Software without prior written authorization of the copyright holder.

11. Freetype, a Free, High-Quality, and Portable Font Engine

The software is based in part of the work of the FreeType Team.

See <http://freetype.sourceforge.net/>, and in particular <http://freetype.sourceforge.net/FTL.TXT>.

Portions of the relevant license conditions are copied below.

The FreeType Project LICENSE

2006-Jan-27

Copyright 1996-2002, 2006 by David Turner, Robert Wilhelm, and Werner Lemberg

...

1. No Warranty

THE FREETYPE PROJECT IS PROVIDED 'AS IS' WITHOUT WARRANTY OF ANY KIND, EITHER EXPRESS OR IMPLIED, INCLUDING, BUT NOT LIMITED TO, WARRANTIES OF MERCHANTABILITY AND FITNESS FOR A PARTICULAR PURPOSE. IN NO EVENT WILL ANY OF THE AUTHORS OR COPYRIGHT HOLDERS BE LIABLE FOR ANY DAMAGES CAUSED BY THE USE OR THE INABILITY TO USE, OF THE FREETYPE PROJECT.

2. Redistribution

This license grants a worldwide, royalty-free, perpetual and irrevocable right and license to use, execute, perform, compile, display, copy, create derivative works of, distribute and sublicense the FreeType Project (in both source and object code forms) and derivative works thereof for any purpose; and to authorize others to exercise some or all of the rights granted herein, subject to the following conditions:

...

- o Redistribution in binary form must provide a disclaimer that states that the software is based in part of the work of the FreeType Team, in the distribution documentation. We also encourage you to put an URL to the FreeType web page in your documentation, though this isn't mandatory.

...

12. International Components for Unicode

COPYRIGHT AND PERMISSION NOTICE

Copyright (c) 1995-2009 International Business Machines Corporation and others

All rights reserved.

Permission is hereby granted, free of charge, to any person obtaining a copy of this software and associated documentation files (the "Software"), to deal in the Software without restriction, including without limitation the rights to use, copy, modify, merge, publish, distribute, and/or sell copies of the Software, and to permit persons to whom the Software is furnished to do so, provided that the above copyright notice(s) and this permission notice appear in all copies of the Software and that both the above copyright notice(s) and this permission notice appear in supporting documentation.

THE SOFTWARE IS PROVIDED "AS IS", WITHOUT WARRANTY OF ANY KIND, EXPRESS OR IMPLIED, INCLUDING BUT NOT LIMITED TO THE WARRANTIES OF MERCHANTABILITY, FITNESS FOR A PARTICULAR PURPOSE AND NONINFRINGEMENT OF THIRD PARTY RIGHTS. IN NO EVENT SHALL THE COPYRIGHT HOLDER OR HOLDERS INCLUDED IN THIS NOTICE BE LIABLE FOR ANY CLAIM, OR ANY SPECIAL INDIRECT OR CONSEQUENTIAL DAMAGES, OR ANY DAMAGES WHATSOEVER RESULTING FROM LOSS OF USE, DATA OR PROFITS, WHETHER IN AN ACTION OF CONTRACT, NEGLIGENCE OR OTHER TORTIOUS ACTION, ARISING OUT OF OR IN CONNECTION WITH THE USE OR PERFORMANCE OF THIS SOFTWARE.

Except as contained in this notice, the name of a copyright holder shall not be used in advertising or otherwise to promote the sale, use or other dealings in this Software without prior written authorization of the copyright holder.

13. Expat

Copyright (c) 1998, 1999, 2000 Thai Open Source Software Center Ltd and Clark Cooper

Copyright (c) 2001, 2002, 2003, 2004, 2005, 2006 Expat maintainers.

Permission is hereby granted, free of charge, to any person obtaining a copy of this software and associated documentation files (the "Software"), to deal in the Software without restriction, including without limitation the rights to use, copy, modify, merge, publish, distribute, sublicense, and/or sell copies of the Software, and to permit persons to whom the Software is furnished to do so, subject to the following conditions:

The above copyright notice and this permission notice shall be included in all copies or substantial portions of the Software.

THE SOFTWARE IS PROVIDED "AS IS", WITHOUT WARRANTY OF ANY KIND, EXPRESS OR IMPLIED, INCLUDING BUT NOT LIMITED TO THE WARRANTIES OF MERCHANTABILITY, FITNESS FOR A PARTICULAR PURPOSE AND NONINFRINGEMENT.

IN NO EVENT SHALL THE AUTHORS OR COPYRIGHT HOLDERS BE LIABLE FOR ANY CLAIM, DAMAGES OR OTHER LIABILITY, WHETHER IN AN ACTION OF CONTRACT, TORT OR OTHERWISE, ARISING FROM, OUT OF OR IN CONNECTION WITH THE SOFTWARE OR THE USE OR OTHER DEALINGS IN THE SOFTWARE.

14. DNS Resolver

The DNS resolver code, taken from BIND 4.9.5, is copyrighted both by UC Berkeley and by Digital Equipment Corporation. The DEC portions are under the following license:

Portions Copyright (C) 1993 by Digital Equipment Corporation.

Permission to use, copy, modify, and distribute this software for any purpose with or without fee is hereby granted, provided that the above copyright notice and this permission notice appear in all copies, and that the name of Digital Equipment Corporation not be used in advertising or publicity pertaining to distribution of the document or software without specific, written prior permission.

THE SOFTWARE IS PROVIDED "AS IS" AND DIGITAL EQUIPMENT CORP. DISCLAIMS ALL WARRANTIES WITH REGARD TO THIS SOFTWARE, INCLUDING ALL IMPLIED WARRANTIES OF MERCHANTABILITY AND FITNESS. IN NO EVENT SHALL DIGITAL EQUIPMENT CORPORATION BE LIABLE FOR ANY SPECIAL, DIRECT, INDIRECT, OR CONSEQUENTIAL DAMAGES OR ANY DAMAGES WHATSOEVER RESULTING FROM LOSS OF USE, DATA OR PROFITS, WHETHER IN AN ACTION OF CONTRACT, NEGLIGENCE OR OTHER TORTIOUS ACTION, ARISING OUT OF OR IN CONNECTION WITH THE USE OR PERFORMANCE OF THIS SOFTWARE.

15. getnameinfo, getaddrinfo

The files `inet/getnameinfo.c` and `sysdeps/posix/getaddrinfo.c` are copyright (C) by Craig Metz and are distributed under the following license:

```
/* The Inner Net License, Version 2.00
```

The author(s) grant permission for redistribution and use in source and binary forms, with or without modification, of the software and documentation provided that the following conditions are met:

0. If you receive a version of the software that is specifically labelled as not being for redistribution (check the version message and/or README), you are not permitted to redistribute that version of the software in any way or form.
1. All terms of the all other applicable copyrights and licenses must be followed.
2. Redistributions of source code must retain the authors' copyright notice(s), this list of conditions, and the following disclaimer.
3. Redistributions in binary form must reproduce the authors' copyright notice(s), this list of conditions, and the following disclaimer in the documentation and/or other materials provided with the distribution.
4. [The copyright holder has authorized the removal of this clause.]
5. Neither the name(s) of the author(s) nor the names of its contributors may be used to endorse or promote products derived from this software without specific prior written permission.

THIS SOFTWARE IS PROVIDED BY ITS AUTHORS AND CONTRIBUTORS "AS IS" AND ANY EXPRESS OR IMPLIED WARRANTIES, INCLUDING, BUT NOT LIMITED TO, THE IMPLIED WARRANTIES OF MERCHANTABILITY AND FITNESS FOR A PARTICULAR PURPOSE ARE DISCLAIMED. IN NO EVENT SHALL THE AUTHORS OR CONTRIBUTORS BE LIABLE FOR ANY DIRECT, INDIRECT, INCIDENTAL,

SPECIAL, EXEMPLARY, OR CONSEQUENTIAL DAMAGES (INCLUDING, BUT NOT LIMITED TO, PROCUREMENT OF SUBSTITUTE GOODS OR SERVICES; LOSS OF USE, DATA, OR PROFITS; OR BUSINESS INTERRUPTION) HOWEVER CAUSED AND ON ANY THEORY OF LIABILITY, WHETHER IN CONTRACT, STRICT LIABILITY, OR TORT (INCLUDING NEGLIGENCE OR OTHERWISE) ARISING IN ANY WAY OUT OF THE USE OF THIS SOFTWARE, EVEN IF ADVISED OF THE POSSIBILITY OF SUCH DAMAGE.

If these license terms cause you a real problem, contact the author: */

16. libpng

This copy of the libpng notices is provided for your convenience. In case of any discrepancy between this copy and the notices in the file png.h that is included in the libpng distribution, the latter shall prevail.

COPYRIGHT NOTICE, DISCLAIMER, and LICENSE:

If you modify libpng you may insert additional notices immediately following this sentence.

This code is released under the libpng license.

libpng versions 1.2.6, August 15, 2004, through 1.2.41, December 3, 2009, are Copyright (c) 2004, 2006-2009 Glenn Randers-Pehrson, and are distributed according to the same disclaimer and license as libpng-1.2.5 with the following individual added to the list of Contributing Authors

Cosmin Truta

libpng versions 1.0.7, July 1, 2000, through 1.2.5 - October 3, 2002, are

Copyright (c) 2000-2002 Glenn Randers-Pehrson, and are distributed according to the same disclaimer and license as libpng-1.0.6 with the following individuals added to the list of Contributing Authors

Simon-Pierre Cadieux

Eric S. Raymond

Gilles Vollant

and with the following additions to the disclaimer:

There is no warranty against interference with your enjoyment of the library or against infringement. There is no warranty that our efforts or the library will fulfill any of your particular purposes or needs. This library is provided with all faults, and the entire risk of satisfactory quality, performance, accuracy, and effort is with the user.

libpng versions 0.97, January 1998, through 1.0.6, March 20, 2000, are Copyright (c) 1998, 1999 Glenn Randers-Pehrson, and are distributed according to the same disclaimer and license as libpng-0.96, with the following individuals added to the list of Contributing Authors:

Tom Lane

Glenn Randers-Pehrson

Willem van Schaik

libpng versions 0.89, June 1996, through 0.96, May 1997, are Copyright (c) 1996, 1997 Andreas Dilger

Distributed according to the same disclaimer and license as libpng-0.88, with the following individuals added to the list of Contributing Authors:

John Bowler

Kevin Bracey

Sam Bushell

Magnus Holmgren

Greg Roelofs

Tom Tanner

libpng versions 0.5, May 1995, through 0.88, January 1996, are Copyright (c) 1995, 1996 Guy Eric Schalnat, Group 42, Inc.

For the purposes of this copyright and license, "Contributing Authors" is defined as the following set of individuals:

Andreas Dilger

Dave Martindale

Guy Eric Schalnatz
Paul Schmidt
Tim Wegner

The PNG Reference Library is supplied "AS IS". The Contributing Authors and Group 42, Inc. disclaim all warranties, expressed or implied, including, without limitation, the warranties of merchantability and of fitness for any purpose. The Contributing Authors and Group 42, Inc. assume no liability for direct, indirect, incidental, special, exemplary, or consequential damages, which may result from the use of the PNG Reference Library, even if advised of the possibility of such damage.

Permission is hereby granted to use, copy, modify, and distribute this source code, or portions hereof, for any purpose, without fee, subject to the following restrictions:

1. The origin of this source code must not be misrepresented.
2. Altered versions must be plainly marked as such and must not be misrepresented as being the original source.
3. This Copyright notice may not be removed or altered from any source or altered source distribution.

The Contributing Authors and Group 42, Inc. specifically permit, without fee, and encourage the use of this source code as a component to supporting the PNG file format in commercial products. If you use this source code in a product, acknowledgment is not required but would be appreciated.

A "png_get_copyright" function is available, for convenient use in "about" boxes and the like:

```
printf("%s",png_get_copyright(NULL));
```

Also, the PNG logo (in PNG format, of course) is supplied in the files "pngbar.png" and "pngbar.jpg (88x31) and "pngnow.png" (98x31).

Libpng is OSI Certified Open Source Software. OSI Certified Open Source is a certification mark of the Open Source Initiative.

Glenn Randers-Pehrson

glennrp at users.sourceforge.net

December 3, 2009

17. SQLite

All of the deliverable code in SQLite has been dedicated to the HYPERLINK "http://en.wikipedia.org/wiki/Public_Domain" public domain by the authors. All code authors, and representatives of the companies they work for, have signed affidavits dedicating their contributions to the public domain and originals of those signed affidavits are stored in a firesafe at the main offices of HYPERLINK "<http://www.hwaci.com>" Hwaci. Anyone is free to copy, modify, publish, use, compile, sell, or distribute the original SQLite code, either in source code form or as a compiled binary, for any purpose, commercial or non-commercial, and by any means.

The previous paragraph applies to the deliverable code in SQLite - those parts of the SQLite library that you actually bundle and ship with a larger application. Portions of the documentation and some code used as part of the build process might fall under other licenses. The details here are unclear. We do not worry about the licensing of the documentation and build code so much because none of these things are part of the core deliverable SQLite library.

All of the deliverable code in SQLite has been written from scratch. No code has been taken from other projects or from the open internet. Every line of code can be traced back to its original author, and all of those authors have public domain dedications on file. So the SQLite code base is clean and is uncontaminated with licensed code from other projects.

