

ZANUSSI

Instructions for the use and care of SL 227 T washing machine

Index

Technical data	page	2
Installation	page	3
Electrical connection	page	6
Operating instructions	page	7
Filling with washing powder	page	8
Wash programmes	page	10
Care and cleaning	page	16
Helpful tips for washing	page	18

Technical data

Width	23,6 ins (600 mm)
Overall depth (excluding hose)	22.0 ins (560 mm)
Height	33.5 ins (850 mm)
Weight	178.5 lbs (80 kg)
Dry clothes capacity (excluding synthetic fabrics and wool)	9 lbs (4,5 kg)
Heater rating	2500 W
Motor rating during washing	300 W
Motor rating during spinning	600 W
Water load: normal level	3.1 gals (14 l)
Water load: high level	4.4 gals (20 l)
Maximum water pressure	110 p.s.i. 758 kN/m ²
Minumim water pressure (cold)	7 p.s.i. 49 kN/m ²
Minimum water pressure (hot)	4 p.s.i. 27 kN/m ²
Supply voltage	220 ÷ 240 V

Installation

Unpacking

Remove the cardboard packing, reinforcing angle pieces and polythene wrapping and proceed as follows:

Tilt the machine and remove base packing (fig. 1).

Remove back panel and bracket securing motor to back of the appliance (fig. 2)

Remove the screws securing the top of the machine and lift it off.

Remove the screws and nuts which fix the transit bar (fig. 3) to the cabinet.

Replace top and back panel.

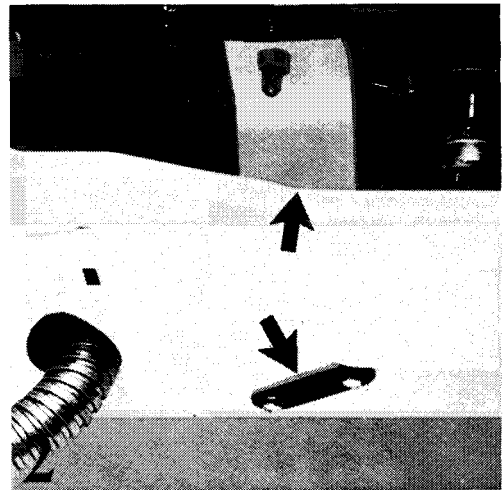
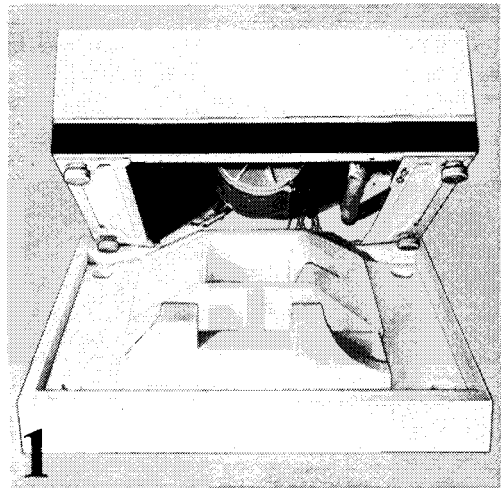

Levelling

Move the washing machine to its permanent operating position and carefully level it by adjusting the feet, locking them in position with the lock nut (A fig. 4).

It is important that special care is taken in the levelling of the appliance in order to avoid any vibration or movement during operation.

When positioning the machine, a small space must be allowed all round, so that it cannot touch the walls or adjacent furniture while it is operating.

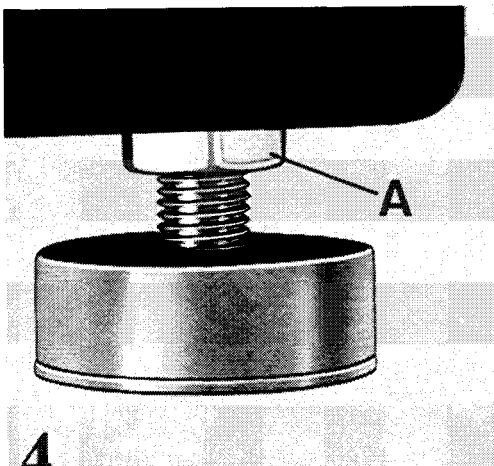
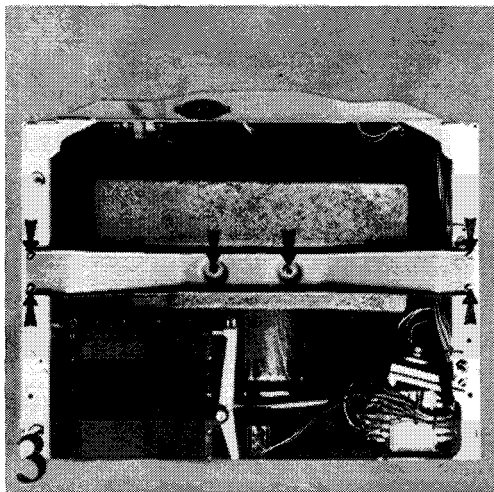

Water connection

The machine may either be plumbed in or connected to existing taps. Details are given below.

Water supply

Separate supplies of hot and cold water are necessary. Single outlet gas or electric heaters are not suitable.

Water outlet connection

The drain pipe from this machine must connect into the main drain from the premises, but **not** into the rainwater drain. Information as to the type of drain servicing your premises can be obtained from a builder or the Local Authority.

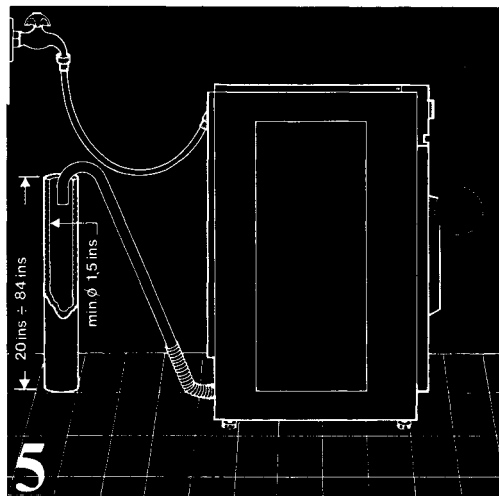

The curved end of the outlet hose should be firmly hooked over the edge of a sink or connected to a suitable drain pipe in the wall or under the sink; however, such a drain pipe should have a built-in air break in order to avoid water syphoning from the machine during draining. The top of the drain hose (curved end) should not be lower than 50 cms (20 ins) or higher than 85 cms (34 ins) from floor level. The water should be able to drain freely and the end of the outlet hose must not be under water. It is, therefore, advisable that the drain pipe, if used, has an internal diameter of at least 4 cms (1.5 ins). Also ensure that the drain hose is not chocked or placed in such a way as to obstruct the normal water flow. If the drain hose is to be hooked over the sink, ensure that the sink is empty and that the sink plug is not blocking the plug hole. If an extension is required, its inner diameter must be the same as that of the original hose of the washer and its length must not exceed 2 metres (6 ft).

Plumbed installation

It is important that work is carried out by a qualified plumber.

Use from existing taps

Mixer taps are unsuitable and must not be used.

Connect the red pipe connection to the hot tap and the other to the cold tap (see note below).

Important

If the rate of flow on the cold water valve is too slow, remove the flow control device of the valve;

If the pressure on the hot tap exceeds approximately 10 lb. per square inch, it will be necessary to fit the flow control device, which is supplied with the washing machine, in the hot water valve.

Tap connections

For taps with a 3/4 inch gas thread, fit the washers to the inlet hoses and connect as shown (fig. 6).

If the water supply is from new pipes or from pipes which have not been used for a long time, it is advisable to run off a certain amount of water before connecting the machine.

This will avoid foreign matter blocking the filters.

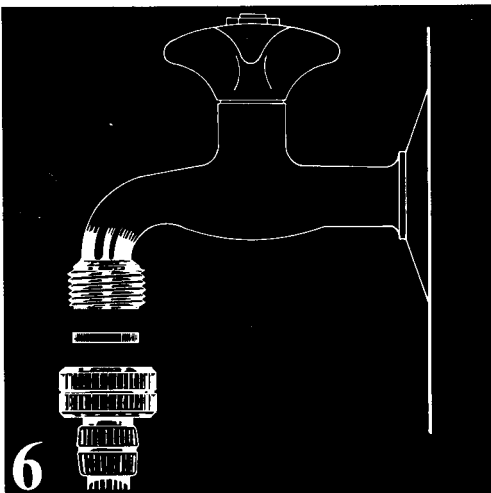

Electrical connection

Warning: this appliance must be earthed. The manufacturer declines to accept any liability should this safety measure not be observed.

Important

The wires in this mains lead are coloured in accordance with the following code:
GREEN AND YELLOW -EARTH
BLUE -NEUTRAL
BROWN -LIVE.

If you fit your own plug, the colours of the wires in the mains lead of your appliance may not correspond with the markings identifying the terminals in your plug; this is what you have to do:

Connect the green and yellow (earth) wire to the terminal in the plug which is marked with the letter "E" or the earth symbol \perp , or coloured green, or green and yellow.

Connect the blue (neutral) wire to the terminal in the plug which is marked with the letter "N" or coloured black.

Connect the brown (live) wire to the terminal which is marked with the letter "L" or coloured red.

The plug moulded on to the cord incorporates a fuse. For replacement, use a 13 Amp. BS 1362 fuse.

Only ASTA approved or certified fuses should be used.

The fuse cover/carrier must be replaced in the event of changing fuse.

The plug must not be used if the fuse cover/carrier is lost.

A replacement cover/carrier must be obtained from Zanussi Service Agents whose addresses are listed on the attached "Zanussi Service Agents Nationwide".

This appliance complies with E.E.C. directive No. 76/889 of 4.11.76 relative to radio interference suppression.

Operating instructions

Preliminary check

Carry out the following checks before using the machine:

is the plug in the socket and is the power switched on?

are the water inlet hoses connected to the taps and the taps turned on?

has the drain hose been placed over the edge of a sink or in a drain?

is the machine door properly closed?

Starting and stopping

To start the machine, select the programme required by turning the time control knob to the required number and pull out the control knob. It should be noted that this knob freewheels in the «on» position, therefore the programme selection cannot be changed without switching the machine off.

Once the machine is started, it will automatically carry out all operations up to the end of the programme chosen and will automatically stop. To switch the machine off or stop the machine in the course of a programme, push in the timer control knob.

As a safety feature the door is automatically locked during the washing cycle and remains locked for a further 60-120 seconds after the machine finishes the programme or is switched off. As an additional safety feature the door is also fitted with a double action catch.

To open the door pull the little handle to the left and, at the same time, rotate it towards the exterior (fig. 7).

It should be noted that at the end of the washing programme a small amount of water collects in the folds of the door gasket: this is normal and care should be taken to avoid dripping when opening the door. This water, anyway, can easily be removed with the aid of a sponge.

Selection of washing programme

The washing machine carries out 10 washing programmes and 3 additional programmes. Each programme has been specially designed for a specific type of fabric (e.g. cotton, synthetic fibres, wool etc.) and incorporates the H.L.C.C. care labelling scheme.

The appropriate programme must therefore be chosen according to the type of fabric to be washed.

Filling with washing powder

The washing powder dispenser is located on the front left of the control panel.

It is very important to use a low sudsing powder (see paragraph «Which powder») such as Persil Automatic.



Pull out the dispenser and add washing powder. The amount of washing powder for the prewash (2-3 ozs) should be put into section «A» of the dispenser (fig. 8) and the powder for the main wash (3-4 ozs) should be put into section «B». Once the dispenser is filled, close by pushing in.

Use of additives

The washing machine is designed to carry out special treatments such as the addition of fabric conditioners automatically at the end of some washing programmes. The liquids to be used should be put into compartment C (fig. 8) of the dispenser at the beginning of the programme and will be automatically used by the machine at the appropriate time. Take care to use the correct amount of additive, following the manufacturer's instructions.

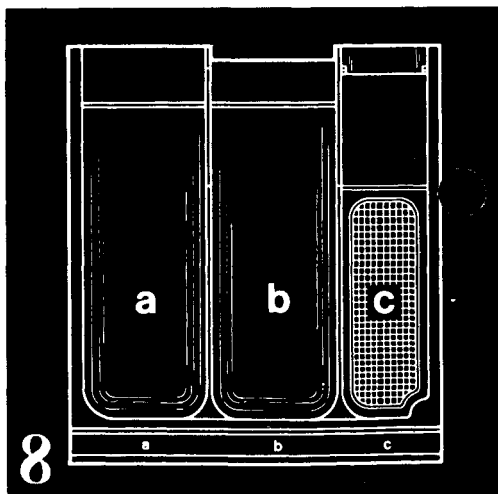

Which powder?

Do not use ordinary powders like Ariel, Radiant, Daz etc. in your new Zanussi SL227T. The reason for this is very simple, these powders produce so much lather that clothes are prevented from tumbling freely and cannot get properly clean.

Do use the right powder. To get the best results from the SL227T we recommend **Persil Automatic**. Like all modern automatic machines the SL227T works at peak efficiency with a low lather product.

Persil Automatic's balanced lather is specially designed to complement the cleaning action of these machines. So use it regularly for trouble free washing and superb results.

Do use enough powder. To get your clothes really clean it is essential that enough powder is used in the machine. The correct amount will depend on a number of things: the hardness of water, the size of the load, and the amount of soiling present. As a guide we suggest you follow the table below and adjust the amounts in light of your personal experience. You may find it helps to use a measuring cup at first.

Small Load or Light Soiling	Full Load or Heavy Soiling
Soft Water 1 cup	Soft Water 1 - 2 cups
Hard Water 1 - 2 cups	Hard Water 2 - 3 cups

Washing programmes

Whites-heavy soil

A

Whites

B

Fast Coloureds - heavy soil

C

Fast Coloureds

D

Non Fast Coloureds

E

Rinses

F

Cotton - Linen

Prewash: fills to low water level and heats to approximately 40°C with a vigorous tumbling action.

Main Wash: fills to low water level and heats to approximately 90°C with gentle tumbling action.

4 rinses at high water level followed by a 5 minute spin.

Put the powder required for prewash into compartment «A» and for the main wash into compartment «B».

If required, pour the additive into compartment «C», taking care not to fill above the level of the filter incorporated in this compartment.

Main Wash: fills to low water level and heats to approximately 90°C with gentle tumbling action.

4 rinses at high water level followed by a 5 minute spin.

Put the powder required for the wash into compartment «B».

If required, pour the additive into compartment «C», taking care not to fill above the level of the filter incorporated in this compartment.

Prewash: fills to low water level and heats to approximately 40°C with a vigorous tumbling action.

Main Wash: fills to low water level and heats to approximately 60°C with gentle tumbling action.

4 rinses at high water level followed by a 5 minute spin.

Put the powder required for prewash into compartment «A» and for the main wash into compartment «B».

If required the additive into compartment «C», taking care not to fill above the level of the filter incorporated in this compartment.

Main Wash: fills to low water level and heats to approximately 60°C with gentle tumbling action.

4 rinses at high water level followed by a 5 minute spin.

Put the powder required for the wash into compartment «B».

If required, pour the additive into compartment «C», taking care not to fill above the level of the filter incorporated in this compartment.

Main Wash: fills to low water level and heats to approximately 40°C with gentle tumbling action.

4 rinses at high water level followed by a 5 minute spin.

Put the powder required for the wash into compartment «B».

If required, pour the additive into compartment «C», taking care not to fill above the level of the filter incorporated in this compartment.

4 rinses in cold water at high water level followed by a 5 minute spin.

Special Treatments

G

Spin

H

White Nylon - Heavy Soil 3/

Synthetics - wool - delicates

I

White nylon 3/

L

Minimum Iron 4/

M

Delicates 6/

Note: There is no water draining in the last rinse of the gentle action wash cycles to prevent the clothes from creasing if they are left in the machine at the end of the wash cycle. To complete the cycle, turn the timer knob centering it on the letter "S", to obtain the water draining followed by a 1 minute spin.

Do not forget to drain the water prior to opening the door.

N

Rinse with cold water at low water level followed by a 5 minute spin.

Pour the additive into compartment «C», taking care not to fill above the level of the filter incorporated in this compartment.

5 minute spin.

Prewash: fills to high water level and heats to approximately 40°C with gentle tumbling action.

Main Wash: fills to high water level and heats to approximately 60°C with gentle tumbling action.

3 rinses at high water level followed by a 1 minute spin.

Put the powder required for prewash into compartment «A» and for the main wash into compartment «B».

If required, pour the additive into compartment «C», taking care not to fill above the level of the filter incorporated in this compartment.

Main Wash: fills to high water level and heats to approximately 60°C with gentle tumbling action.

3 rinses at high water level followed by a 1 minute spin.

Put the powder required for the wash into compartment «B».

If required, pour the additive into compartment «C», taking care not to fill above the level of the filter incorporated in this compartment.

Main Wash: fills to high water level and heats to approximately 48°C with gentle tumbling action.

3 rinses at high water level followed by a 1 minute spin.

Put the powder required for the wash into compartment «B».

If required, pour the additive into compartment «C», taking care not to fill above the level of the filter incorporated in this compartment.

Main Wash: fills to high water level and heats to approximately 40°C with gentle tumbling action.

3 rinses at high water level followed by a 1 minute spin.

Put the powder required for the wash into compartment «B».

If required, pour the additive into compartment «C», taking care not to fill above the level of the filter incorporated in this compartment.

P

Drain

S

Purpose of the «Economizing Cycle» Pushbutton

If you require to wash a reduced load of clothes (maximum 4 lbs), by pressing in the pushbutton marked by the letter E all water loads will be effected only up to normal level.

This ensures a substantial saving in terms of time electric power consumption although it still gives very good washing results.

This pushbutton should not be used when washing woollens as these require a wash cycle and rinses with plenty of water.

Purpose of the «Non Crease» Pushbutton

When washing synthetics or «drip dry» materials on cycles I - L - M - N we suggest to depress the pushbutton marked by the symbol .

The washing machine will thus operate in such a way as to avoid the creasing of synthetic fabrics.

Note:The «non crease» pushbutton should not be selected when washing woollens.

Main Wash: fills to high water level and heats to approximately 40°C with gentle tumbling action.
3 rinses at high water level followed by a 1 minute spin.

Put the powder required for the wash into compartment «B».
If required, pour the additive into compartment «C», taking care not to fill above the level of the filter incorporated in this compartment.

Water draining followed by a 1 minute spin.

Care and cleaning of the machine

Important: Make sure that the plug has been removed from the socket prior to undertaking any kind of maintenance. From time to time, carry out a complete cycle without a washing load, adding 1 oz of «Calgon». This should also be done when the washer has been out of use for a long time.

Leave the door ajar for about 2 hours after the wash to allow air to circulate freely inside the machine.

Plated, polished and plastic parts and the glass door should be cleaned with a soft damp cloth, never with an abrasive cleaning powder.

For the cabinet exterior use a lukewarm solution of mild soap, then rinse and dry carefully. It is also advisable to clean the cabinet, from time to time, with a wax polish applied with a soft cloth.

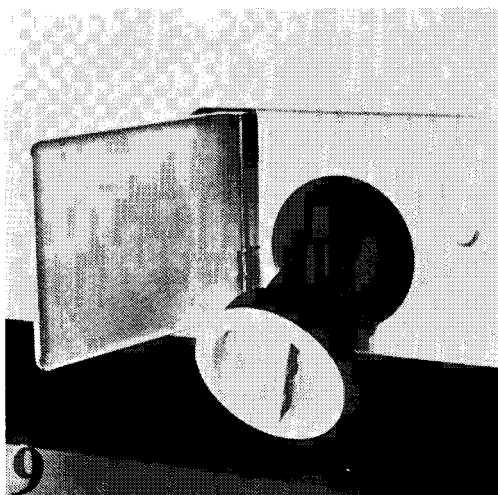

Filter cleaning

The filter (fig. 9) is located on the front of the washer in the bottom right hand corner. Its purpose is to collect fluff and any small objects (safety-pins, coins, etc.) inadvertently left in the laundry.

The filter should be periodically cleaned as follows:

At the end of a washing programme place the free end of the drain hose at floor level in a basin to collect any excess water.

Before removing the filter, place a small bowl on the floor below the filter cover to collect any water that may come out.

Unscrew the filter knob anti-clockwise and pull the filter out (fig. 9).

Clean filter and refit, ensuring that the filter knob is screwed tight.

Hints for care of washing powder dispenser

We recommend that the washing powder dispenser is checked regularly to ensure that it is clean and dry. Do wipe the dispenser after each wash.

Should the dispenser require special cleaning, the drawer can be completely removed, and the interior cleared of any deposit.

The drawer can be removed from the front of the appliance by giving a sharp pull outwards. A sharp tap with the palm of the hand may be necessary when replacing the drawer.

Helpful tips for washing

Here are some practical hints to enable you to obtain the best washing results:

Use a low suds washing powder such as «Persil Automatic» specially made for front loading washing machines.

An excessive formation of suds will cause unsatisfactory operation.

The quantity of washing powder required depends on the amount of laundry and on how soiled it is. It may therefore be necessary to vary the quantities suggested in this book according to experience. To obtain the best results when washing wool do not wash more than 2 lbs. at a time.

In order to get good results when washing synthetic material use a maximum washing load of 5 to 6 lbs.

If your water is hard it can be softened by adding special products such as «Calgon» to the washing powder in the appropriate compartment. These products facilitate the action of the washing powder and help to give better results.

Clothes should be sorted according to fabric type, degree of soil and colour fastness.

Tears and open seams should be mended, loose buttons secured, zippers closed and laces or belts collected in a cotton bag.

Articles without a hem should not be washed. Ensure pockets are emptied and spots of rust paint, ink etc. removed before washing.

Always turn off water taps fully when the machine is not in use, even if it is plumbed in.

If, after commencing a wash, you find that the wrong programme has been selected, push the control knob fully in turning the indicator knob clockwise to the correct programme. Then pull control knob fully out again.

Washing powder should only be placed in the dispenser immediately prior to the start of a programme. Do not leave washing powder in the dispenser for any

length of time as it may form lumps which can be difficult to dissolve.

It is advisable to inspect the filters in the water inlet hoses periodically and clean if necessary.

Special cycle for washing wool garments bearing the Woolmark Label «Pure New Wool», including blankets and wool mixtures with cotton or rayon. Silk.

Servicing

Should servicing be required for this appliance contact your local Service Agent but before requesting service the following simple checks may save you inconvenience and expenses:

Check that the power supply is working (by plugging in another appliance).

Check that the fuse has not blown in the plug.

Check that the door is properly closed and the water taps are turned on.

Check that the drain filter or water inlets are not blocked.

Check that the drain hose is properly located and free from kinks and blockages.

ZANUSSI GUARANTEE CONDITIONS

This guarantee is in addition to your statutory and other legal rights which will not be excluded or in any way diminished by the return of this guarantee.

We, IAZ International (UK) Ltd, guarantee that if within twelve months of the date of the purchase, this ZANUSSI appliance or any part thereof is proved to be defective by reason only of faulty workmanship or materials we will at our option repair or replace the same **FREE OF ANY CHARGE** for labour, materials or carriage on condition that:

- The appliance has been correctly installed and used only on the electricity supply stated on rating plate.
- The appliance has been used for normal domestic purposes and in accordance with the manufacturer's operating and maintenance instructions.
- The appliance has not been serviced, maintained, repaired, taken apart or tampered with by any person not authorised by us.

- The appliance is still in the possession of the original purchaser.
- Any appliance or defective part replaced shall become our property.

This guarantee does not cover any damage caused during transportation or the replacement of any light bulbs or removable parts of glass or plastic.

Should you require service on your Zanussi appliance consult the enclosed list of service agents for your nearest Zanussi engineer. If the product is under guarantee then you will be required to produce proof of date of purchase to the engineer.

Please ensure that the enclosed pre-addressed card is stamped, completed in full and forwarded to IAZ International (UK) Ltd, to enable the guarantee to be recorded. Also complete the space below as your own record of the guarantee.

GUARANTEE RECORD

Appliance purchased from _____ on _____
Guarantee card no _____ Model no _____
Serial no _____ (These details may be taken from your Guarantee Record Card)
Your name _____
Address _____

