

KM-NET for Direct Printing
Operation Guide

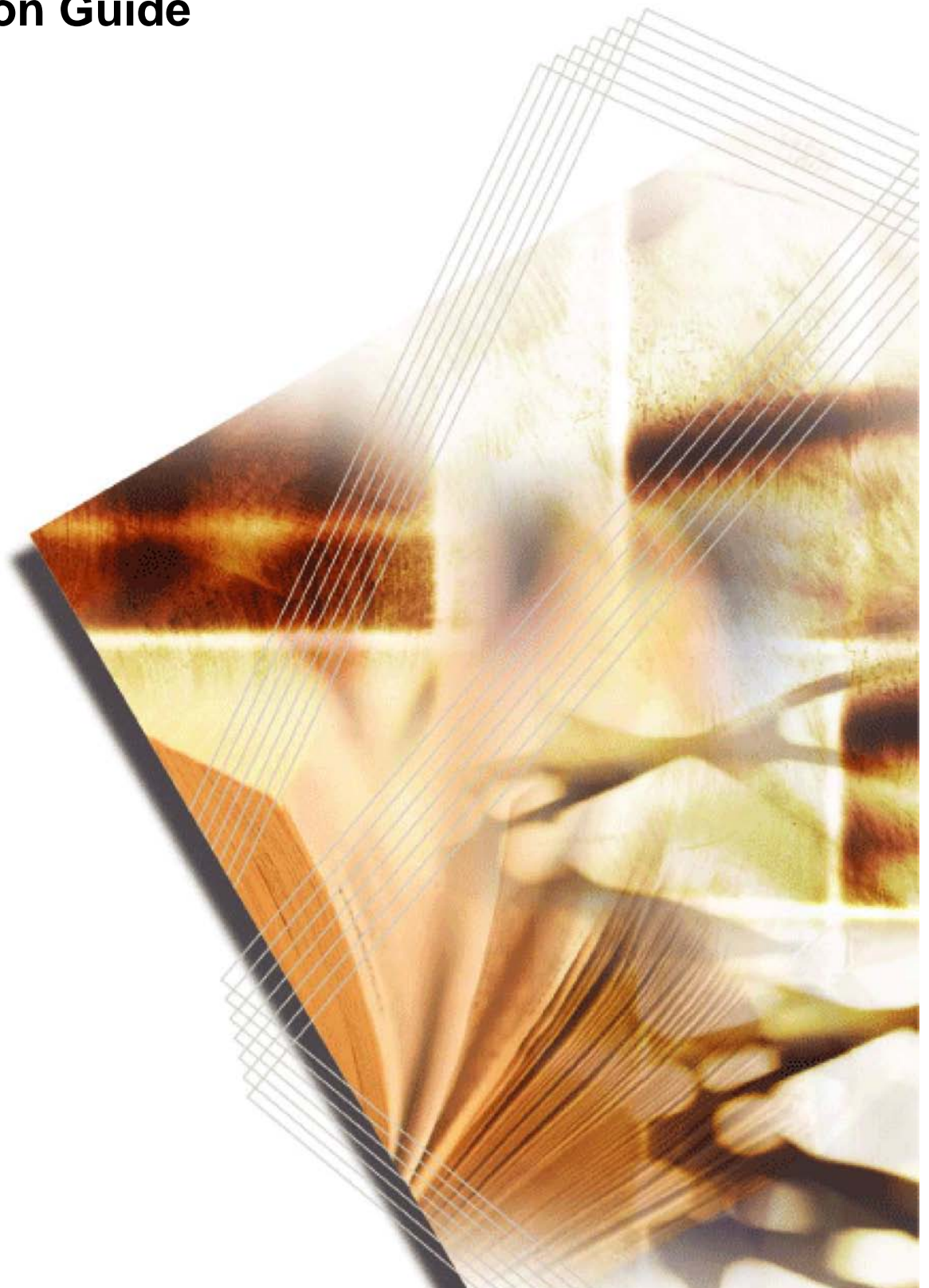

Legal and General Information

Notice

Unauthorized reproduction of all or part of this guide is prohibited. The information in this guide is subject to change without notice.

Kyocera Mita cannot be held liable for any problems arising from the use of this product, regardless of the information herein.

Regarding Trademarks

KYOCERA, KYOCERA MITA, ECOSYS and PRESCRIBE are registered trademarks of Kyocera Corporation.

KPDL and KIR (Kyocera Image Refinement) are trademarks of Kyocera Corporation.

Microsoft, Windows and Windows NT are registered trademarks of Microsoft Corporation.

Apple, AppleTalk, Mac, Macintosh, Mac OS and TrueType are registered trademarks of Apple Computer, Inc.

Adobe, Acrobat and Postscript are registered trademarks of Adobe Systems Incorporated.

Novell and NetWare are registered trademarks of Novell, Inc.

HP and PCL are registered trademarks of Hewlett-Packard Company.

Intel, Pentium and Celeron are registered trademarks of Intel Corporation.

Other brand and product names contained in this document are registered trademarks or trademarks of their respective companies.

General Information

When using this utility, the items that can be configured will differ depending on the model of your printing system or multifunctional printer (hereinafter referred to as "printing system").

Examples in this document are described in terms of the Internet Explorer 6.0 and Microsoft Windows XP operating system environment.

Table of Contents

1. Features	1
1.1. What is KM-NET for Direct Printing?	1
1.2. System Requirements.....	1
1.3. Support Language	1
2. Installation and Startup	2
2.1. Installation.....	2
2.2. Startup	2
3. Printing PDF	3
4. Names and Functions.....	5
5. Printing System Settings	6
6. Detailed Settings.....	10

1. Features

1.1. What is KM-NET for Direct Printing?

KM-NET for Direct Printing is a utility that allows you to print PDF files downloaded from Internet such as catalog and documents without starting Adobe Acrobat/Reader.

1.2. System Requirements

The KM-NET for Direct Printing operates in the following environment. Verify your environment before installation.

Item	Description
OS	Microsoft Windows 98 SE/Me Microsoft Windows NT 4.0 Workstation Service Pack 6 or later† Microsoft Windows 2000 Professional† Microsoft Windows XP Home Edition/Professional Edition†
Web Browser	Microsoft Internet Explorer 5.5 or later
Hardware	A processor equivalent to a Pentium 200 MHz or greater At least 32 MB of free memory At least 4 MB of free hard disk space SVGA (800 × 600, 256 color) or greater

† Administrator rights are required for installation.

1.3. Support Language

KM-NET for Direct Printing supports the following languages: Arabic, Brazilian Portuguese, Czech, Danish, Dutch, English, Finnish, Farsi, French, German, Hebrew, Hungarian, Italian, Japanese, Lithuanian, Korean, Norwegian, Polish, Portuguese, Russian, Simplified Chinese, Spanish, Swedish, Traditional Chinese and Turkish.

2. Installation and Startup

2.1. Installation

Install KM-NET for Direct Printing in your computer.

Note

Before installing this utility, make sure that any of the printer drivers are installed. The **Kyocera Extended Driver** is provided on the CD-ROM supplied with the printing system.

Insert the CD-ROM that came with the printing system into the optical drive of the computer.

The installation program starts up automatically. Follow the instructions for installation.

2.2. Startup

When the installation is completed, you can start the **KM-NET for Direct Printing** by proceeding from the start menu > **All Programs > Kyocera > KM-NET for Direct Printing**.

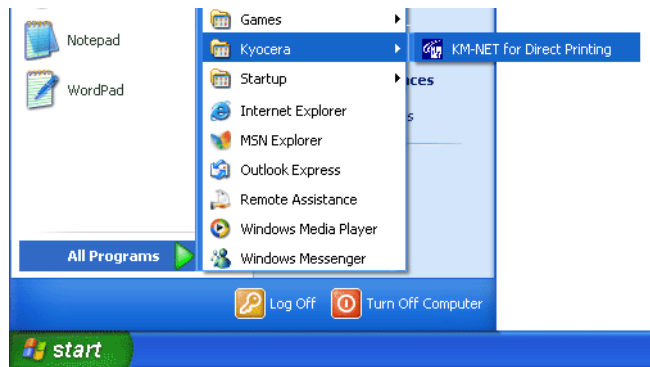

3. Printing PDF

Perform the following procedures below to print PDF file using **KM-NET for Direct Printing**.

1 Start **KM-NET for Direct Printing**.

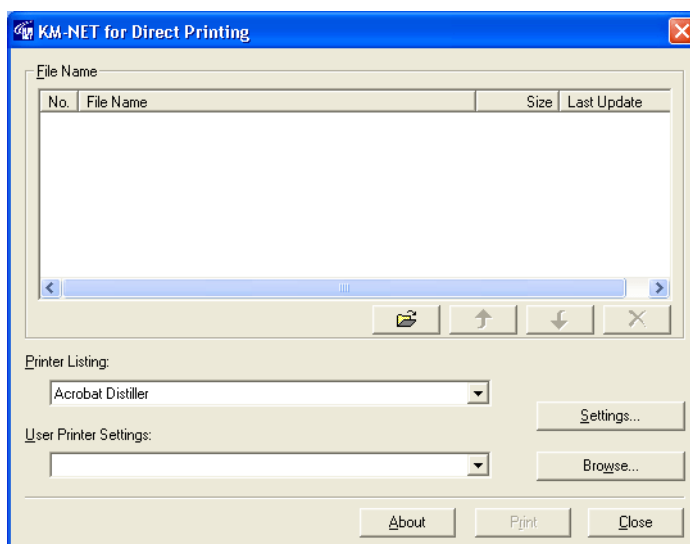

2 Add the desired PDF files to the **File Name** list by the following methods.

- Click the **Add** button to select files from the **Open File** dialog box.
- Select the file in Windows explorer and then drag and drop it to the icon for this application (including shortcut).
- Select the file in Windows explorer and then select **KM-NET for Direct Printing** in the context menu.
- Select the file and then drag and drop it to this window.

3 Select the printing system to print PDF files from the **Printer Listing** pull-down menu.

4 Click the **Settings** button and make settings for printing. For details, refer to *Printing System Settings* on page 6.

Note

When you want to load the previously saved setting, select the setting file from the **User Printer Settings** pull-down menu or click the **Browse** button.

5 Click the **Detailed Settings** button and make the detailed settings such as page range for printing and media type. For details, refer to *Detailed Settings* on page 10.

6 Click the **Print** button. The **Confirmation** dialog box appears.

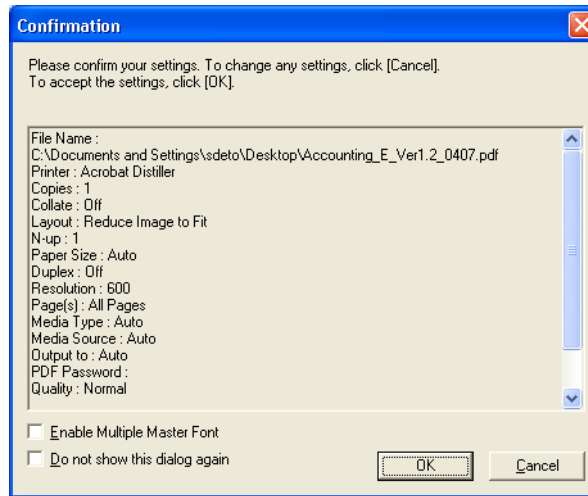

Notes





- Checking **Enable Multiple Master Font** and then clicking **OK** enable to generate a version of a character that is optically correct for the size at which it will be viewed on PDF file.
- Checking **Do not show this dialog again** and then clicking **OK** can not be displayed the **Confirmation** dialog box.

7 When you want to continue printing, click **OK**.

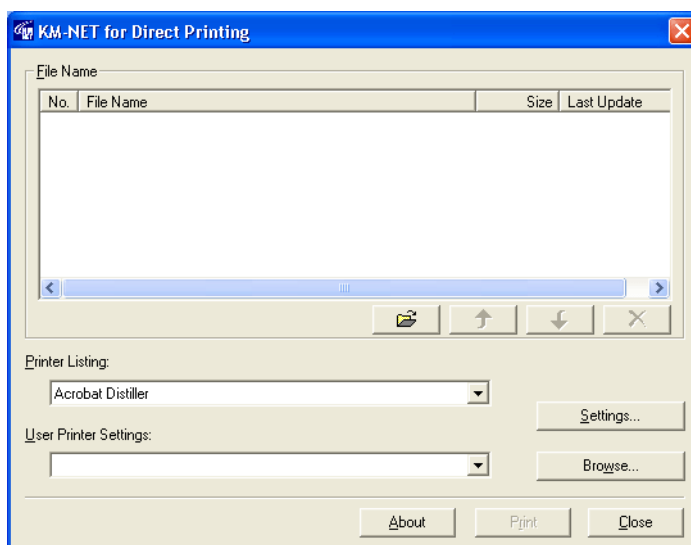
4. Names and Functions

When you start this utility, the window below appears.



Name and Icon	Description
Add button 	Displays the Open File dialog box. When you select a valid file, file name, file size and last update are displayed in the File Name list.
Up button 	Moves order of selected files up one or down one.
Down button 	Note You can also change the order by selecting a file and then dragging it to the order you want to change.
Delete button 	Deletes the selected file from the list. Note You can also delete a file by selecting a file and then pressing the Del key on the keyboard.
Printer Listing	Displays the printing systems installed in the system. Select the output target printing system here.
Settings button	Displays the printing system setting dialog box.
User Printer Settings	Displays the names of setting files saved previously.
Browse button	Displays the Open File dialog box to load previously saved setting files.
About button	Displays the version and copyright of this utility.
Print button	Starts the printing process of the file displayed in the File Name list.
Close button	Exits this utility.

5. Printing System Settings

You can make frequently used settings as default.

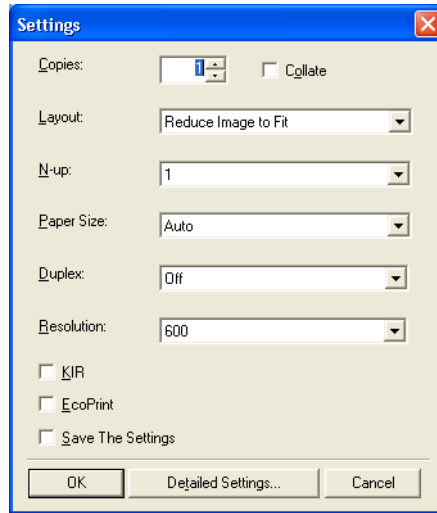

Copies

Specifies the number of copies. The default setting is 1.

Collate

Produces the specified number of copies as complete sets of documents. The default setting is disabled (not checked).

Layout

Specifies the layout of the output. The following layouts are available: **Reduce Image to Fit**, **Through**, **Catalog (Left to Right)**, **Catalog (Right to Left)**, **Booklet (Left Edge Binding)** and **Booklet (Right Edge Binding)**. The default setting is **Reduce Image to Fit**.

When you select **Reduce Image to Fit**, the image is enlarged or reduced to fit the printing area of the paper specified in **Paper Size**.

When you select **Through**, the image is printed in the same size as the original page regardless of paper size.

When you select **Catalog (Left to Right)**, **Catalog (Right to Left)**, **Booklet (Left Edge Binding)** or **Booklet (Right Edge Binding)**, the printing order is as follows.

• **Catalog (Left to Right)**

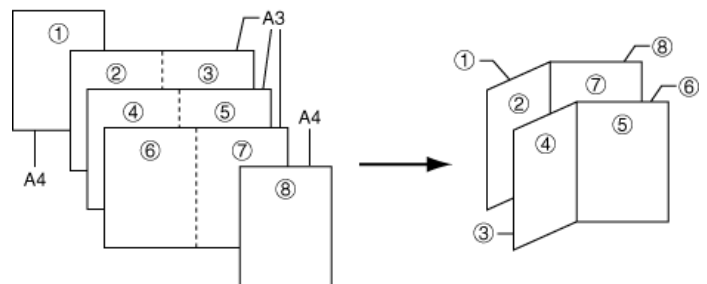

Original page order

Printing result

• **Catalog (Right to Left)**

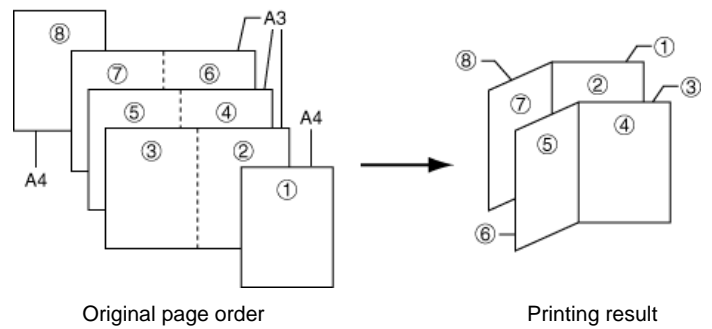

Note

If the page order is not in the same order as shown above, the printing results will vary.

• **Booklet (Left Edge Binding)**

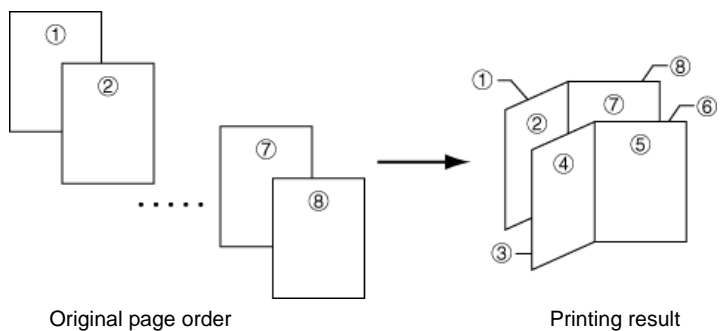

• **Booklet (Right Edge Binding)**

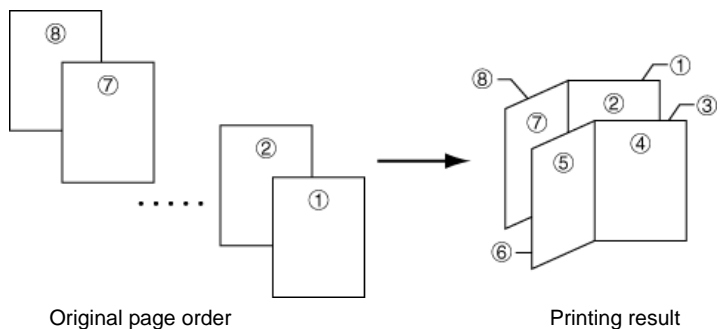

Note

Confirm the paper size and load the paper into the cassette before printing. For example, to change the booklet configured in A4 portrait into the double spread page in A3 size, load the A3 size paper. If you load the A4 paper in landscape, a single side is reduced in A5 size, and the double spread pages in A4 are printed.

N-up

Specifies the number of pages per sheet. The following value is available: **1**, **2** and **4**. The default setting is **1**.

When N-up settings 2 or 4 are used, the page layouts are as follows.

2-up

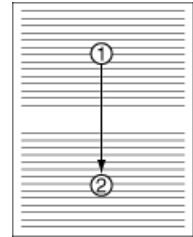
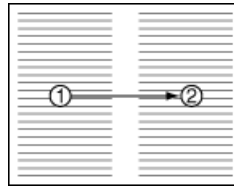

4-up

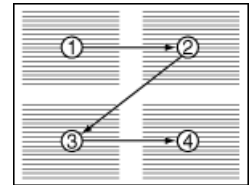
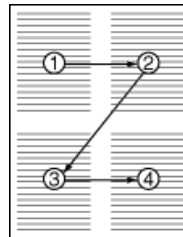

Note

If you select **Through** in **Layout**, the value of **N-up** is fixed at 1 and cannot be changed. Furthermore, if you select **Catalog** or **Booklet**, the value is fixed at 2 and cannot be changed.

Paper Size

Specifies the paper size applied to the output. The following paper sizes are available:
16K, 8K, A3, A4, A5, A6, Auto, B4, B5, B6, C4, Envelope #10, Envelope #6, Envelope #9, Envelope C5, Envelope DL, Executive, Folio, Hagaki, ISO B5, Ledger, Legal, Letter, Monarch, Oficio II, OufukuHagaki, Statement, Youkei 2 and Youkei 4. The default setting is **Auto**.

Duplex

Sets 2-sided printing. The following modes are available: **Off, Flip on Long Edge** and **Flip on Short Edge**. The default setting is **Off**.

Notes

If you select **Catalog** or **Booklet** in **Layout**, the value of **Duplex** is fixed at the **Flip on Short Edge** and cannot be changed.

This utility does not automatically recognize whether or not a duplex printing unit is present in a printing system. Therefore, there is a possibility that the duplex printing settings set here may be invalid.

Resolution

Specifies the printing resolution. The following resolutions are available: **300, 600, Fast 1200** and **Fine 1200**. The default setting is **600**.

KIR

KIR (Kyocera Image Refinement) is a smoothing function that enhances resolution, resulting in high-quality printing. The default setting is disabled (not checked).

EcoPrint

Enables the printing system to reduce the amount of toner consumption to save printing costs. The default setting is disabled (not checked).

- Save The Settings** Saves settings in a file.
When checked, click **OK** to save the settings. You can select the saved file by **Load Setting File** in the main window. The default setting is disabled (not checked)
- Detailed Settings** Displays another dialog box to perform more detailed settings. Information on using the **Detailed Settings** dialog box can be found on the following page

6. Detailed Settings

You can make select media type, media source and other detailed settings in this dialog box.

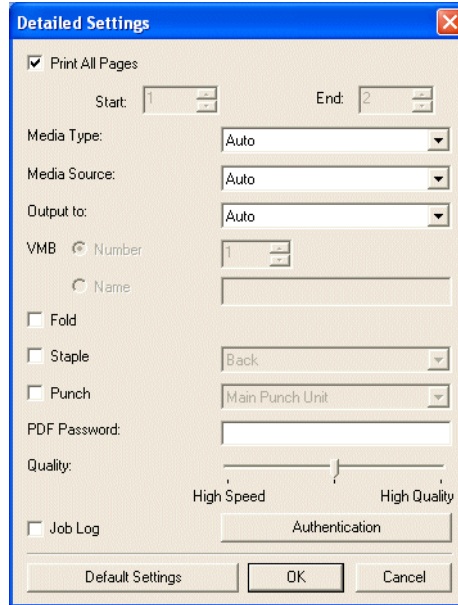

Print All Pages

Check to print all pages.

If you remove this check, the range entry boxes are active. Specify the page range for printing.

Note

If you select **Catalog** in **Layout** of the **Settings** dialog box, **Print All Pages** is automatically checked and cannot be changed.

Media Type

Selects the media type used for printing. The following media types are available: **Auto, Plain, Transparency, Preprinted, Labels, Bond, Recycled, Vellum, Rough, Letterhead, Color, Prepunched, Envelope, Cardstock, Coated, 2nd Side, Thick, High Quality** and **Custom 1** (to 8). The default setting is **Auto**.

Media Source

Specifies the paper supply cassette. The following media sources are available: **Auto, Multi Purpose Tray, Cassette1, Cassette2, Cassette3, Cassette4, Cassette5, Cassette6** and **Envelope Feeder**. The default setting is **Auto**.

Note

The setting may be ignored depending on the configuration of the printing system.

Output to	<p>Specifies the paper output destination. The following destinations are available: Auto, Face Up Tray, Face Down Tray, Finisher Tray (Face Down) and VMB. The default setting is Auto.</p> <p>Note The setting may be ignored depending on the configuration of the printing system.</p>
VMB (Virtual MailBox)	<p>This is active when VMB is specified as the Output to destination above. Virtual Mailbox feature, mailboxes created on the hard disk are assigned to multiple users. Jobs posted to a virtual mailbox can be printed later from the operation panel of the printing system.</p> <p>Number: specifies the mailbox by the number. the number should be 1 to 255.</p> <p>Name: specifies the mailbox by the name.</p> <p>Note The setting may be ignored depending on the configuration of the printing system.</p>
Fold	<p>Folds copies for booklet format. The default setting is disabled (not checked).</p>
Staple	<p>Staples each copy set. The default setting is disabled (not checked).</p> <p>When this item is enabled, the combo box is active allowing you to select that result. The following staple positions are available: Back, Booklet and Front.</p>
Punch	<p>Makes copies hole punched. The default setting is disabled (not checked).</p> <p>When this item is enabled, the combo box is active allowing you to select that result. The following value are available: Main Punch Unit and Sub Punch Unit.</p> <p>Note The setting may be ignored depending on the configuration of the printing system.</p>
PDF Password	<p>Enter the password required to print encrypted PDF files. The password should be 32 characters maximum.</p>
Quality	<p>You can choose the printing quality, from High Quality to High Speed. Move the slider to the left to select a High Speed or to the right to select a High Quality. The default setting is center.</p> <p>Note The setting is enabled only when the PDF file to print is PDF version 1.4 or later file and using Transparency Flattening function. Otherwise the setting is ignored.</p> <p>PDF version can be confirmed on the window displayed by which selecting from File menu > Document Properties > Summary.</p> <p>Transparency Flattening function can be confirmed on the Advanced Print Setup dialog box.</p>

Job Log

Maintains a log in the system that indicates printed PDF files and the date/time of printing. Entering a check mark for this item enables the Job Log.

For details on the Job Log, refer to the Operation Guide of the printing system.

Authentication

Displays **Authentication** dialog box.

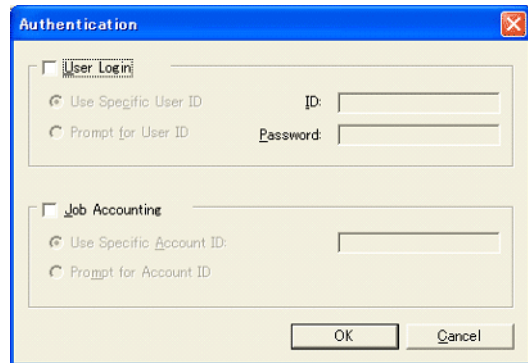

User Login

To use user login function, click **User Login** to check. For details on user login function, refer to *Operation Guide* of the printing system. Select **Use Specific User ID** when always printing with same ID. Select **Prompt for User ID** when printing with several different IDs. This prompt you to enter the **User ID** and **Password** at each time you print on the printing system.

Job Accounting

To use job accounting function, click Job Accounting to check. For details on job accounting, refer to *Operation Guide* of the printing system. Select **Use Specific Account ID** when always printing with same ID. Select **Prompt for Account ID** when printing with several different IDs. This prompt you to enter the **Account ID** at each time you print on the printing system.

Default Settings

Returns all settings to their initial state.

KYOCERA MITA AMERICA, INC.

Headquarters:

225 Sand Road,
Fairfield, New Jersey 07004-0008
TEL : (973) 808-8444
FAX : (973) 882-6000

New York Branch:

1410 Broadway 23rd floor
New York, NY 10018
TEL : (917) 286-5400
FAX : (917) 286-5402

Northeastern Region:

225 Sand Road,
Fairfield, New Jersey 07004-0008
TEL : (973) 808-8444
FAX : (973) 882-4401

Midwestern Region:

201 Hansen Court Suite 119
Wood Dale, Illinois 60191
TEL : (630) 238-9982
FAX : (630) 238-9487

Western Region:

14101 Alton Parkway,
Irvine, California 92618-7006
TEL : (949) 457-9000
FAX : (949) 457-9119

Southeastern Region:

1500 Oakbrook Drive,
Norcross, Georgia 30093
TEL : (770) 729-9786
FAX : (770) 729-9873

Southwestern Region:

2825 West Story Road,
Irving, Texas 75038-5299
TEL : (972) 550-8987
FAX : (972) 252-9786

National Operation Center

& National Training Center:

2825 West Story Road,
Irving, Texas 75038-5299
TEL : (972) 659-0055
FAX : (972) 570-5816

Latin America Division:

8240 N.W. 52nd. Terrace Dawson Building,
Suite 108 Miami, Florida 33166
TEL : (305) 421-6640
FAX : (305) 421-6666

KYOCERA MITA CANADA, LTD.

6120 Kestrel Road, Mississauga,
Ontario L5T 1S8, Canada
TEL : (905) 670-4425
FAX : (905) 670-8116

KYOCERA MITA MEXICO, S.A. DE C.V.

Av. 16 de Septiembre #407
Col. Santa Inés,
Azcapotzalco México,
D.F. 02130, México
TEL : (55) 5383-2741
FAX : (55) 5383-7804

KYOCERA MITA EUROPE B.V.

Hoeksteen 40, 2132 MS Hoofddorp,
The Netherlands
Phone: +31.20.654.0000
Home page: <http://www.kyoceramita-europe.com>
Email: info@kyoceramita-europe.com

KYOCERA MITA NEDERLAND B.V.
Beechavenue 25, 1119RA Schiphol-Rijk
The Netherlands
Phone: +31.20.58.77.200

KYOCERA MITA (UK) LTD
8 Beacontree Plaza
Gillette Way Reading Berks RG2 OBS,
U.K.
Phone: +44.1189.311.500

KYOCERA MITA ITALIA S.p.A.
Via G. Verdi, 89 / 91, 20063 Cernusco s/N
Milano, Italy
Phone: +39.02.92179.1

S.A. KYOCERA MITA BELGIUM N.V.
Hermesstraat 8A, 1930 Zaventem,
Belgium
Phone: +32.2.720.9270

KYOCERA MITA FRANCE S.A.
Parc Les Algorithmes Saint Aubin
91194 GIF-SUR-YVETTE,
France
Phone: +33.1.6985.2600

KYOCERA MITA ESPAÑA S.A.
Edificio Kyocera, Avda de Manacor No. 2,
28290 Las Matas (Madrid),
Spain
Phone: +34.91.631.8392

KYOCERA MITA FINLAND OY
Kirvesmiehenkatu 4, 00880 Helsinki,
Finland
Phone: +358.9.4780.5200

KYOCERA MITA (SCHWEIZ)
Hohlstrasse 614, 8048 Zürich
Switzerland
Phone: +41.1.908.4949

KYOCERA MITA DEUTSCHLAND GMBH
Mollsfeld 12, 40670 Meerbusch,
Germany
Phone: +49.2159.918.0

KYOCERA MITA GMBH AUSTRIA
Eduard-Kittenberger-Gasse 95,
1230 Wien,
Austria
Phone: +43.1.86338.210

KYOCERA MITA SVENSKA AB
Vretenvägen 2, 6tr, 17 154 Solna,
Sweden
Phone: +46.8.546.55000

KYOCERA MITA NORGE
Postboks 150 Oppsal, NO 0619 Oslo
Olaf Helsetsvei 6, NO 0694 Oslo,
Norway
Phone: +47.22.62.73.00

KYOCERA MITA DANMARK A/S
Ejby Industrivej 1, DK-2600 Glostrup,
Denmark
Phone: +45.5687.1100

KYOCERA MITA PORTUGAL LDA.
Rua do Centro Cultural, 41 (Alvalade) 1700-106 Lisbon,
Portugal
Phone: +351.21.842.9100

KYOCERA MITA SOUTH AFRICA (PTY) LTD.
527 Kyalami Boulevard,
Kyalami Business Park Midrand,
South Africa
Phone: +27.(0)11.540.2600

KYOCERA MITA AMERICA, INC.

Headquarters:
225 Sand Road,
Fairfield, New Jersey 07004-0008,
U.S.A.
Phone: (973) 808-8444

KYOCERA MITA AUSTRALIA PTY. LTD.
Level 3, 6-10 Talavera Road, North Ryde,
N.S.W. 2113 Australia
Phone: (02) 9888-9999

KYOCERA MITA NEW ZEALAND LTD.
1-3 Parkhead Place, Albany
P.O. Box 302 125 NHPC, Auckland,
New Zealand
Phone: (09) 415-4517

KYOCERA MITA (THAILAND) CORP., LTD.
9/209 Ratchada-Prachachem Road,
Bang Sue, Bangkok 10800, Thailand
Phone: (02) 586-0320

KYOCERA MITA SINGAPORE PTE LTD.
121 Genting Lane, 3rd Level,
Singapore 349572
Phone: 67418733

KYOCERA MITA HONG KONG LIMITED
11/F., Mita Centre,
552-566, Castle Peak Road,
Tsuen Wan, New Territories,
Hong Kong
Phone: 24297422

KYOCERA MITA TAIWAN Corporation.
7F-1~2, No.41, Lane 221, Gangchi Rd.
Neihu District, Taipei, Taiwan, 114. R.O.C.
Phone: (02) 87511560

KYOCERA MITA Corporation

2-28, 1-chome, Tamatsukuri, Chuo-ku
Osaka 540-8585, Japan
Phone: (06) 6764-3555
<http://www.kyoceramita.com>

