



# *HTR-5940*

---

*AV Receiver*

OWNER'S MANUAL

# IMPORTANT SAFETY INSTRUCTIONS

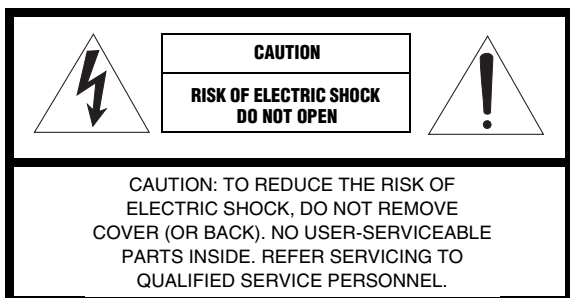

## • Explanation of Graphical Symbols



The lightning flash with arrowhead symbol, within an equilateral triangle, is intended to alert you to the presence of uninsulated “dangerous voltage” within the product’s enclosure that may be of sufficient magnitude to constitute a risk of electric shock to persons.



The exclamation point within an equilateral triangle is intended to alert you to the presence of important operating and maintenance (servicing) instructions in the literature accompanying the appliance.

- 1 Read Instructions – All the safety and operating instructions should be read before the product is operated.
- 2 Retain Instructions – The safety and operating instructions should be retained for future reference.
- 3 Heed Warnings – All warnings on the product and in the operating instructions should be adhered to.
- 4 Follow Instructions – All operating and use instructions should be followed.
- 5 Cleaning – Unplug this product from the wall outlet before cleaning. Do not use liquid cleaners or aerosol cleaners.
- 6 Attachments – Do not use attachments not recommended by the product manufacturer as they may cause hazards.
- 7 Water and Moisture – Do not use this product near water – for example, near a bath tub, wash bowl, kitchen sink, or laundry tub; in a wet basement; or near a swimming pool; and the like.
- 8 Accessories – Do not place this product on an unstable cart, stand, tripod, bracket, or table. The product may fall, causing serious injury to a child or adult, and serious damage to the product. Use only with a cart, stand, tripod, bracket, or table recommended by the manufacturer, or sold with the product. Any mounting of the product should follow the manufacturer’s instructions, and should use a mounting accessory recommended by the manufacturer.
- 9 A product and cart combination should be moved with care. Quick stops, excessive force, and uneven surfaces may cause the product and cart combination to overturn.



- 10 Ventilation – Slots and openings in the cabinet are provided for ventilation and to ensure reliable operation of the product and to protect it from overheating, and these openings must not be blocked or covered. The openings should never be blocked by placing the product on a bed, sofa, rug, or other similar surface. This product should not be placed in a built-in installation such as a bookcase or rack unless proper ventilation is provided or the manufacturer’s instructions have been adhered to.
- 11 Power Sources – This product should be operated only from the type of power source indicated on the marking label. If you are not sure of the type of power supply to your home, consult your product dealer or local power company. For products intended to operate from battery power, or other sources, refer to the operating instructions.
- 12 Grounding or Polarization – This product may be equipped with a polarized alternating current line plug (a plug having one blade wider than the other). This plug will fit into the power outlet only one way. This is a safety feature. If you are unable to insert the plug fully into the outlet, try reversing the plug. If the plug should still fail to fit, contact your electrician to replace your obsolete outlet. Do not defeat the safety purpose of the polarized plug.
- 13 Power-Cord Protection – Power-supply cords should be routed so that they are not likely to be walked on or pinched by items placed upon or against them, paying particular attention to cords at plugs, convenience receptacles, and the point where they exit from the product.
- 14 Lightning – For added protection for this product during a lightning storm, or when it is left unattended and unused for long periods of time, unplug it from the wall outlet and disconnect the antenna or cable system. This will prevent damage to the product due to lightning and power-line surges.
- 15 Power Lines – An outside antenna system should not be located in the vicinity of overhead power lines or other electric light or power circuits, or where it can fall into such power lines or circuits. When installing an outside antenna system, extreme care should be taken to keep from touching such power lines or circuits as contact with them might be fatal.
- 16 Overloading – Do not overload wall outlets, extension cords, or integral convenience receptacles as this can result in a risk of fire or electric shock.
- 17 Object and Liquid Entry – Never push objects of any kind into this product through openings as they may touch dangerous voltage points or short-out parts that could result in a fire or electric shock. Never spill liquid of any kind on the product.
- 18 Servicing – Do not attempt to service this product yourself as opening or removing covers may expose you to dangerous voltage or other hazards. Refer all servicing to qualified service personnel.
- 19 Damage Requiring Service – Unplug this product from the wall outlet and refer servicing to qualified service personnel under the following conditions:
  - a) When the power-supply cord or plug is damaged,
  - b) If liquid has been spilled, or objects have fallen into the product,
  - c) If the product has been exposed to rain or water,

- d) If the product does not operate normally by following the operating instructions. Adjust only those controls that are covered by the operating instructions as an improper adjustment of other controls may result in damage and will often require extensive work by a qualified technician to restore the product to its normal operation,
  - e) If the product has been dropped or damaged in any way, and
  - f) When the product exhibits a distinct change in performance - this indicates a need for service.
- 20 Replacement Parts** – When replacement parts are required, be sure the service technician has used replacement parts specified by the manufacturer or have the same characteristics as the original part. Unauthorized substitutions may result in fire, electric shock, or other hazards.
- 21 Safety Check** – Upon completion of any service or repairs to this product, ask the service technician to perform safety checks to determine that the product is in proper operating condition.
- 22 Wall or Ceiling Mounting** – This unit should be mounted to a wall or ceiling only as recommended by the manufacturer.
- 23 Heat** – The product should be situated away from heat sources such as radiators, heat registers, stoves, or other products (including amplifiers) that produce heat.

- 24 Outdoor Antenna Grounding** – If an outside antenna or cable system is connected to the product, be sure the antenna or cable system is grounded so as to provide some protection against voltage surges and built-up static charges. Article 810 of the National Electrical Code, ANSI/NFPA 70, provides information with regard to proper grounding of the mast and supporting structure, grounding of the lead-in wire to an antenna discharge unit, size of grounding conductors, location of antenna discharge unit, connection to grounding electrodes, and requirements for the grounding electrode.

EXAMPLE OF ANTENNA GROUNDING



NEC – NATIONAL ELECTRICAL CODE

**Note to CATV system installer:**

This reminder is provided to call the CATV system installer’s attention to Article 820-40 of the NEC that provides guidelines for proper grounding and, in particular, specifies that the cable ground shall be connected to the grounding system of the building, as close to the point of cable entry as practical.

**FCC INFORMATION (for US customers)**

**1 IMPORTANT NOTICE: DO NOT MODIFY THIS UNIT!**

This product, when installed as indicated in the instructions contained in this manual, meets FCC requirements. Modifications not expressly approved by Yamaha may void your authority, granted by the FCC, to use the product.

- 2 IMPORTANT:** When connecting this product to accessories and/or another product use only high quality shielded cables. Cable/s supplied with this product **MUST** be used. Follow all installation instructions. Failure to follow instructions could void your FCC authorization to use this product in the USA.

- 3 NOTE:** This product has been tested and found to comply with the requirements listed in FCC Regulations, Part 15 for Class “B” digital devices. Compliance with these requirements provides a reasonable level of assurance that your use of this product in a residential environment will not result in harmful interference with other electronic devices.

This equipment generates/uses radio frequencies and, if not installed and used according to the instructions found in the users manual, may cause interference harmful to the operation of other electronic devices.

Compliance with FCC regulations does not guarantee that interference will not occur in all installations. If this product is found to be the source of interference, which can be determined by turning this unit “OFF” and “ON”, please try to eliminate the problem by using one of the following measures:

Relocate either this product or the device that is being affected by the interference.

Utilize power outlets that are on different branch (circuit breaker or fuse) circuits or install AC line filter/s.

In the case of radio or TV interference, relocate/reorient the antenna. If the antenna lead-in is 300 ohm ribbon lead, change the lead-in to coaxial type cable.

If these corrective measures do not produce satisfactory results, please contact the local retailer authorized to distribute this type of product. If you can not locate the appropriate retailer, please contact Yamaha Electronics Corp., U.S.A. 6660 Orangethorpe Ave, Buena Park, CA 90620.

The above statements apply **ONLY** to those products distributed by Yamaha Corporation of America or its subsidiaries.

# CAUTION: READ THIS BEFORE OPERATING YOUR UNIT.

- 1 To assure the finest performance, please read this manual carefully. Keep it in a safe place for future reference.
- 2 Install this sound system in a well ventilated, cool, dry, clean place – away from direct sunlight, heat sources, vibration, dust, moisture, and/or cold. Allow ventilation space of at least 30 cm on the top, 20 cm on the left and right, and 20 cm on the back of this unit.
- 3 Locate this unit away from other electrical appliances, motors, or transformers to avoid humming sounds.
- 4 Do not expose this unit to sudden temperature changes from cold to hot, and do not locate this unit in an environment with high humidity (i.e. a room with a humidifier) to prevent condensation inside this unit, which may cause an electrical shock, fire, damage to this unit, and/or personal injury.
- 5 Avoid installing this unit where foreign object may fall onto this unit and/or this unit may be exposed to liquid dripping or splashing. On the top of this unit, do not place:
  - Other components, as they may cause damage and/or discoloration on the surface of this unit.
  - Burning objects (i.e. candles), as they may cause fire, damage to this unit, and/or personal injury.
  - Containers with liquid in them, as they may fall and liquid may cause electrical shock to the user and/or damage to this unit.
- 6 Do not cover this unit with a newspaper, tablecloth, curtain, etc. in order not to obstruct heat radiation. If the temperature inside this unit rises, it may cause fire, damage to this unit, and/or personal injury.
- 7 Do not plug in this unit to a wall outlet until all connections are complete.
- 8 Do not operate this unit upside-down. It may overheat, possibly causing damage.
- 9 Do not use force on switches, knobs and/or cords.
- 10 When disconnecting the power cable from the wall outlet, grasp the plug; do not pull the cord.
- 11 Do not clean this unit with chemical solvents; this might damage the finish. Use a clean, dry cloth.
- 12 Only voltage specified on this unit must be used. Using this unit with a higher voltage than specified is dangerous and may cause fire, damage to this unit, and/or personal injury. YAMAHA will not be held responsible for any damage resulting from use of this unit with a voltage other than specified.
- 13 To prevent damage by lightning, keep the power cable and outdoor antennas disconnected from a wall outlet or this unit during a lightning storm.
- 14 Do not attempt to modify or fix this unit. Contact qualified YAMAHA service personnel when any service is needed. The cabinet should never be opened for any reasons.
- 15 When not planning to use this unit for long periods of time (i.e. vacation), disconnect the AC power plug from the wall outlet.
- 16 Install this unit near the AC wall outlet where the power cable plug can be reached easily.
- 17 Be sure to read the “TROUBLESHOOTING” section on common operating errors before concluding that this unit is faulty.
- 18 Before moving this unit, press STANDBY/ON to set this unit in the standby mode, and then disconnect the power cable from the AC wall outlet.
- 19 **VOLTAGE SELECTOR (Asia and General models only)**  
The VOLTAGE SELECTOR on the rear panel of this unit must be set for your local main voltage BEFORE plugging into the AC wall outlet. Voltages are:  
Asia model ..... 220/230–240 V AC, 50/60 Hz  
General model ..... 110/120/220/230–240 V AC, 50/60 Hz

## WARNING

TO REDUCE THE RISK OF FIRE OR ELECTRIC SHOCK, DO NOT EXPOSE THIS UNIT TO RAIN OR MOISTURE.

This unit is not disconnected from the AC power source as long as it is connected to the wall outlet, even if this unit itself is turned off. In this state, this unit is designed to consume a very small quantity of power.

## FOR CANADIAN CUSTOMERS

To prevent electric shock, match wide blade of plug to wide slot and fully insert.  
This Class B digital apparatus complies with Canadian ICES-003.

## IMPORTANT

Please record the serial number of this unit in the space below.

MODEL:

Serial No.:

The serial number is located on the rear panel of this unit. Retain this Owner’s Manual in a safe place for future reference.

## We Want You Listening For A Lifetime

YAMAHA and the Electronic Industries Association’s Consumer Electronics Group want you to get the most out of your equipment by playing it at a safe level. One that lets the sound come through loud and clear without annoying blaring or distortion – and, most importantly, without affecting your sensitive hearing.

Since hearing damage from loud sounds is often undetectable until it is too late, YAMAHA and the Electronic Industries Association’s Consumer Electronics Group recommend you to avoid prolonged exposure from excessive volume levels.



# CONTENTS

## INTRODUCTION

<b>FEATURES.....</b>	<b>2</b>
<b>GETTING STARTED.....</b>	<b>3</b>
Supplied accessories .....	3
Installing batteries in the remote control .....	3
<b>CONTROLS AND FUNCTIONS .....</b>	<b>4</b>
Front panel.....	4
Remote control.....	6
Front panel display .....	9
Rear panel .....	11

## PREPARATION

<b>CONNECTIONS .....</b>	<b>12</b>
Placing speakers.....	12
Connecting speakers .....	13
Information on jacks and cable plugs .....	16
Audio and video signal flow.....	17
Connecting a TV .....	18
Connecting a DVD player, a DVD recorder, a VCR or an STB.....	19
Connecting a CD player, an MD player or a tape deck.....	21
Connecting a multi-format player or an external decoder .....	22
Connecting a game console, a video camera or a portable audio player.....	22
Connecting the FM and AM antennas .....	23
Connecting the power cable.....	24
Setting the speaker impedance.....	25
Turning on this unit or setting it to the standby mode.....	26
<b>BASIC SETUP .....</b>	<b>27</b>

## BASIC OPERATION

<b>PLAYBACK.....</b>	<b>30</b>
<b>USING OTHER FEATURES.....</b>	<b>32</b>
Using SILENT CINEMA .....	32
Muting the audio output.....	32
Selecting the night listening mode.....	32
Selecting the input mode .....	33
Using the sleep timer .....	34
Adjusting the speaker level.....	35
Selecting the Compressed Music Enhancer mode .....	36
Selecting the MULTI CH INPUT component.....	37
Enjoying multi-channel sources in 2-channel stereo.....	37
Enjoying unprocessed input sources.....	37
Enjoying pure hi-fi stereo sound.....	38
Displaying the input source information .....	38
Playing video sources in the background .....	39

<b>ENJOYING SURROUND SOUND.....</b>	<b>40</b>
Enjoying multi-channel sources in surround .....	40
Enjoying 2-channel sources in surround.....	41
Using Virtual CINEMA DSP .....	42
<b>RECORDING .....</b>	<b>43</b>
<b>FM/AM TUNING .....</b>	<b>44</b>
Automatic tuning .....	44
Manual tuning .....	45
Automatic preset tuning.....	46
Manual preset tuning .....	47
Selecting preset stations.....	48
Exchanging preset stations .....	49
<b>XM® SATELLITE RADIO TUNING.....</b>	<b>51</b>
Connecting the XM Connect-and-Play digital antenna accessory.....	51
XM Satellite Radio controls and functions.....	52
Activating XM Satellite Radio .....	53
Basic XM Satellite Radio operations.....	54
Selecting the XM Satellite Radio search mode .....	55
Setting the XM Satellite Radio preset channels .....	59
Displaying the XM Satellite Radio information.....	60

## SOUND FIELD PROGRAMS

<b>SOUND FIELD PROGRAMS .....</b>	<b>62</b>
Selecting sound field programs .....	62
Sound field program descriptions.....	63
Changing sound field parameter settings.....	65
Sound field program speaker layouts .....	71

## ADVANCED OPERATION

<b>SET MENU .....</b>	<b>74</b>
Using SET MENU.....	76
1 SOUND MENU.....	78
2 INPUT MENU.....	81
3 OPTION MENU .....	83
<b>ADVANCED SETUP .....</b>	<b>84</b>
<b>REMOTE CONTROL FEATURES .....</b>	<b>86</b>
Controlling this unit, a TV, or other components .....	86
Setting remote control codes .....	88
Setting library codes .....	89
Resetting all remote control codes.....	90
<b>RESETTING THE SYSTEM.....</b>	<b>91</b>

## ADDITIONAL INFORMATION

<b>TROUBLESHOOTING .....</b>	<b>92</b>
<b>GLOSSARY .....</b>	<b>97</b>
Audio information .....	97
Video information.....	98
Sound field program information .....	99
<b>SPECIFICATIONS.....</b>	<b>100</b>

# FEATURES

## Built-in 6-channel power amplifier

- ◆ Minimum RMS output power (0.06% THD, 20 Hz to 20 kHz, 8 Ω)  
Front: 90 W + 90 W  
Center: 90 W  
Surround: 90 W + 90 W  
Surround back: 90 W

## Sound field features

- ◆ Proprietary YAMAHA technology for the creation of sound fields
- ◆ Dolby Digital/Dolby Digital EX decoder
- ◆ DTS/DTS-ES Matrix 6.1, Discrete 6.1, DTS Neo:6, DTS 96/24 decoder
- ◆ Dolby Pro Logic/Dolby Pro Logic II/Dolby Pro Logic IIx decoder
- ◆ Neural Surround decoder (U.S.A. and Canada models only)
- ◆ Virtual CINEMA DSP
- ◆ SILENT CINEMA™

## Sophisticated AM/FM tuner

- ◆ 40-station random and direct preset tuning
- ◆ Automatic preset tuning
- ◆ Preset station shifting capability (preset editing)

## XM Satellite Radio (U.S.A. model only)

- ◆ XM Satellite Radio tuning capability (using the “XM Connect-and-Play digital antenna accessory” sold separately)
- ◆ Neural Surround decoder to play back the surround sound content of the XM Satellite Radio broadcasts in multi-channels, resulting in a full surround sound experience

## Other features

- ◆ 192-kHz/24-bit D/A converter
- ◆ 6 additional input jacks for discrete multi-channel input
- ◆ S-video signal input/output capability
- ◆ Component video input/output capability (3 COMPONENT VIDEO INs and 1 MONITOR OUT)
- ◆ Optical and coaxial digital audio signal jacks
- ◆ Sleep timer
- ◆ Cinema and music night listening modes
- ◆ Remote control with preset remote control codes, backlighting input selector buttons
- ◆ PORTABLE mini analog input jack on the front panel for a portable audio player
- ◆ Compressed Music Enhancer mode to improve the sound quality of compression artifacts (such as the MP3 format) to that of a high-quality stereo

## Notes

-  indicates a tip for your operation.
- Some operations can be performed by using either the buttons on the front panel or the ones on the remote control. In case the button names differ between the front panel and the remote control, the button name on the remote control is given in parentheses.
- This manual is printed prior to production. Design and specifications are subject to change in part as a result of improvements, etc. In case of differences between the manual and product, the product has priority.



Manufactured under license from Dolby Laboratories. “Dolby”, “Pro Logic”, and the double-D symbol are trademarks of Dolby Laboratories.



Manufactured under license from Digital Theater Systems, Inc. “DTS”, “DTS-ES”, “NEO:6”, and “DTS 96/24” are trademarks of Digital Theater Systems, Inc. Copyright 1996, 2003 Digital Theater Systems, Inc. All right reserved.

SILENT™  
CINEMA

“SILENT CINEMA” is a trademark of YAMAHA CORPORATION.



READY

The XM name and related logos are registered trademarks of XM Satellite Radio Inc.



Neural Surround™ name and related logos are trademarks owned by Neural Audio Corporation.

# GETTING STARTED

## Supplied accessories

Check that you received all of the following parts.

### Remote control

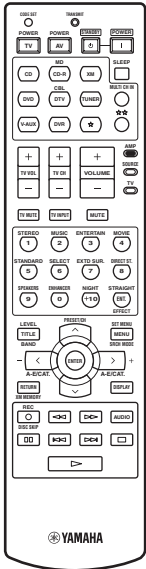

### Batteries (2) (AA, R6, UM-3)

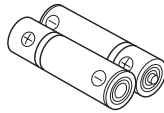

### AM loop antenna



### 75-ohm/300-ohm antenna adapter (U.K. model only)

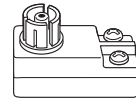

### Indoor FM antenna (U.S.A., Canada, China, Asia and General models)

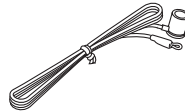

### Indoor FM antenna (U.K., Europe, Australia and Korea models)

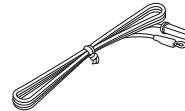

## Installing batteries in the remote control

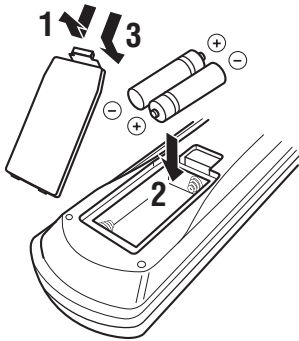

**1** Take off the battery compartment cover.

**2** Insert the two supplied batteries (AA, R6, UM-3) according to the polarity markings (+ and -) on the inside of the battery compartment.

**3** Snap the battery compartment cover back into place.

### Notes

- Change all of the batteries if you notice the following conditions:
  - The operation range of the remote control decreases.
  - The TRANSMIT indicator does not flash or its light becomes dim.
- Do not use an old battery together with a new one.
- Do not use different types of batteries (such as alkaline and manganese batteries) together. Read the packaging carefully as these different types of batteries may have the same shape and color.
- If the batteries have leaked, dispose of them immediately. Avoid touching the leaked material or letting it come into contact with clothing, etc. Clean the battery compartment thoroughly before installing new batteries.
- Do not throw away batteries with general house waste; dispose of them correctly in accordance with your local regulations.
- If the remote control is without batteries for more than 2 minutes, or if exhausted batteries remain in the remote control, the contents of the memory may be cleared. When the memory is cleared, insert new batteries, set up the remote control code and program any acquired functions that may have been cleared.

# CONTROLS AND FUNCTIONS

## Front panel

### Note

The XM Satellite Radio controlling functions in the following buttons (SEARCH MODE, CATEGORY, PRESET/TUNING/CH </>, MEMORY, and DISPLAY) are only applicable to the U.S.A. model and are operational only when "XM" is selected as the input source. For details, see "XM Satellite Radio controls and functions" on page 52.

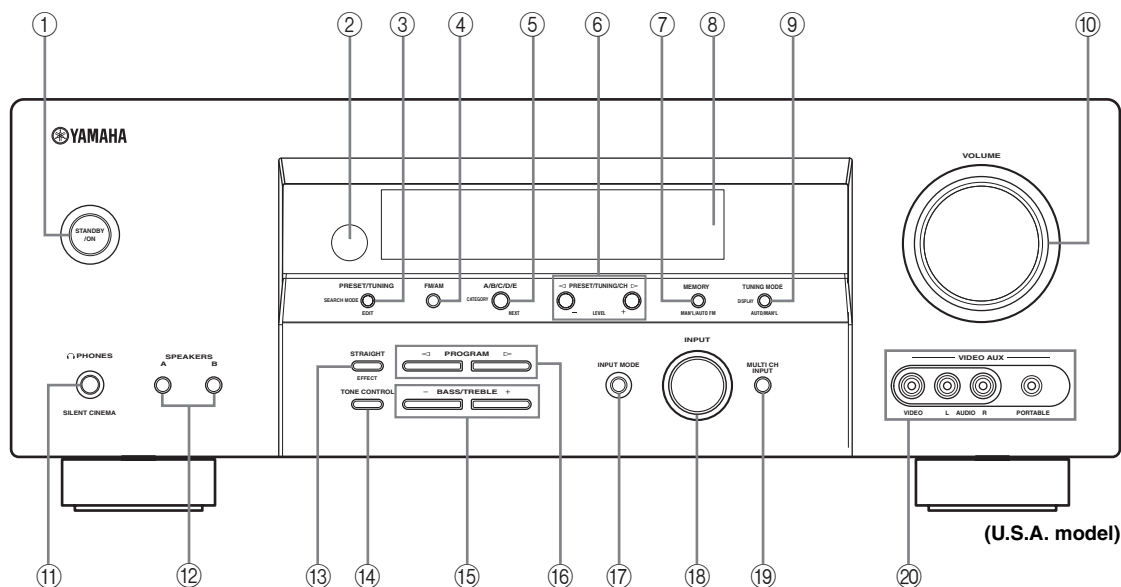

(U.S.A. model)

### ① STANDBY/ON

Turns on this unit or set it to the standby mode (see page 26).

### Notes

- In the standby mode, this unit consumes a small amount of power in order to receive infrared signals from the remote control.
- When you turn on this unit, there will be a 4 to 5-second delay before this unit can reproduce sound.

### ② Remote control sensor

Receives signals from the remote control (see page 8).

### ③ PRESET/TUNING, EDIT

- Switches the function of PRESET/TUNING/CH </> between selecting preset station numbers and selecting the tuning frequency.
- Edits the assignments of preset stations (see page 49).

### ④ FM/AM

Switches the reception band between FM and AM when "TUNER" is selected as the input source (see page 44).

### ⑤ A/B/C/D/E, NEXT

- Selects one of the 5 preset station groups (A to E) when "TUNER" is selected as the input source (see page 44).
- Selects the speaker channel whose output level you want to adjust when "TUNER" is not selected as the input source (see page 35).

### ⑥ PRESET/TUNING/CH </>, LEVEL +/- buttons

- Selects one of the 8 preset station numbers (1 to 8) when "TUNER" is selected as the input source. The colon (:) is displayed in the front panel display (see page 48).
- Selects the tuning frequency when "TUNER" is selected as the input source. The colon (:) is not displayed in the front panel display (see page 45).
- Adjusts the level of the speaker channel selected using NEXT when "TUNER" is not selected as the input source (see page 35).

### ⑦ MEMORY (MAN'L/AUTO FM)

Stores a preset station in the memory. Hold down this button for more than 3 seconds to start automatic preset tuning (see page 46).



**⑧ Front panel display**

Shows information about the operational status of this unit (see page 9).

**⑨ TUNING MODE (AUTO/MAN'L)**

Switches between automatic tuning (the AUTO indicator is turned on) and manual tuning (the AUTO indicator is turned off) (see page 44).

**⑩ VOLUME**

Controls the output level of all audio channels.



This does not affect the AUDIO OUT (REC) level.

**⑪ PHONES (SILENT CINEMA) jack**

Outputs audio signals for private listening with headphones (see page 32).

**Notes**

- When you connect headphones, no signals are output at the SUBWOOFER OUTPUT jack or the speaker terminals.
- All Dolby Digital and DTS audio signals are mixed down to the left and right headphone channels.

**⑫ SPEAKERS A/B buttons**

Turns on or off the set of front speakers connected to the A and/or B terminals on the rear panel each time the corresponding button is pressed.

**⑬ STRAIGHT (EFFECT)**

Turns the sound field programs off or on. When “STRAIGHT” is selected, 2-channel or multi-channel input signals are output directly from their respective speakers without effect processing (see page 37).

**⑭ TONE CONTROL**

Selects “BASS” or “TREBLE” to adjust the total balance of the front left and right speakers in conjunction with the BASS/TREBLE +/- buttons (see page 31).

**⑮ BASS/TREBLE +/- buttons**

Adjust the bass/treble balance of the front left and right speakers in conjunction with TONE CONTROL (see page 31).

**⑯ PROGRAM ◀/▶ buttons**

Selects sound field programs (see page 62).

**⑰ INPUT MODE**

Selects either digital or analog input signals exclusively or sets this unit to automatically detect the type of input signals and select the corresponding input signals when one component is connected via both digital and analog connections (see page 33).

**⑱ INPUT selector**

Selects the desired input source.

**⑲ MULTI CH INPUT**

Selects the input source connected to the MULTI CH INPUT jacks (see page 37).

**Note**

The input source connected to the MULTI CH INPUT jacks takes priority over the source selected with the INPUT selector on the front panel (or the input selector buttons on the remote control).

**⑳ VIDEO AUX jacks**

Input audio and video signals from a portable external source such as a game console, a video camera or a portable audio player (see page 22).



To reproduce the source signals input at these jacks, select “V-AUX” as the input source.

**Note**

The audio signals input at the PORTABLE mini jack take priority over the ones input at the AUDIO L/R jacks.

## Remote control

This section describes the function of each control on the remote control used to control this unit. To operate other components, see “REMOTE CONTROL FEATURES” on page 86.

### Notes

- The XM Satellite Radio controlling functions (XM, XM MEMORY, SRCH MODE, DISPLAY, cursor buttons  $\wedge / \vee / \langle / \rangle$ , numeric buttons and ENT.) are only applicable to the U.S.A. model and are operational only when “XM” is selected as the input source. For details, see “XM Satellite Radio controls and functions” on page 52.
- The operation mode of the remote control buttons in the shaded area below depends on the component selector switch position. Set the component selector switch to AMP to control this unit. To control the TUNER functions, set the component selector switch to SOURCE and then press TUNER to select the “TUNER” as the input source.

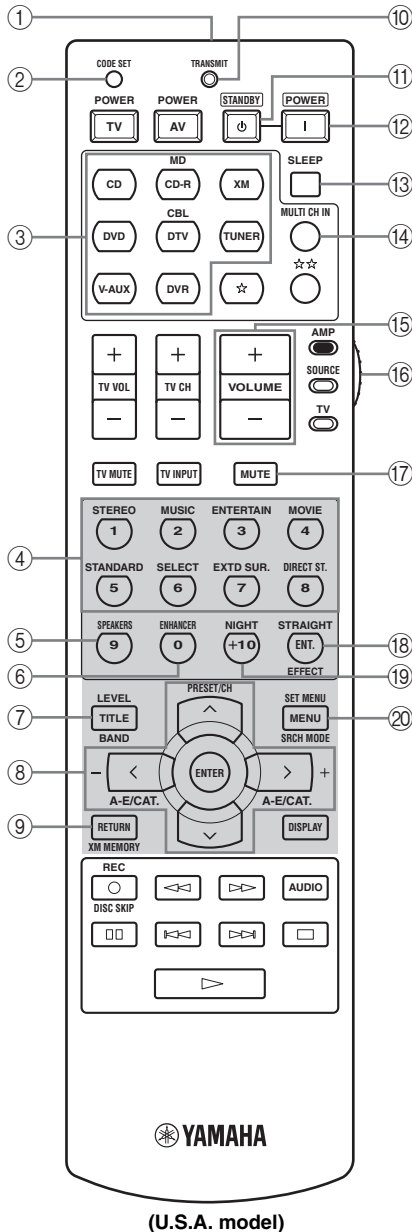

### ■ Controlling this unit

Set the component selector switch to AMP to control this unit.

#### ① Infrared window

Outputs infrared control signals. Aim this window at the component you want to operate (see page 8).

#### ② CODE SET

Use to set up remote control codes (see page 88).

#### ③ Input selector buttons

Select the input source.

### Note

The corresponding input selector button for the currently selected input source lights up for approximately 5 seconds after you press any buttons on the remote control, showing which source component is currently being operated.

#### ④ Sound field program selector buttons

Select sound field programs (see page 62).

- Use SELECT to play back 2-channel sources in surround (see page 41).
- Use EXTD SUR. to switch between 5.1 and 6.1-channel playback of multi-channel sources (see page 40).
- Use DIRECT ST. to play back 2-channel sources in hi-fi stereo sound (see page 38).

#### ⑤ SPEAKERS

Turns on or off the set of front speakers connected to the FRONT A and/or B terminals on the rear panel. Press this button repeatedly to toggle as follows:

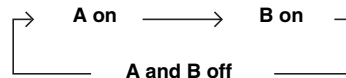

#### ⑥ ENHANCER

Turns on or off the Compressed Music Enhancer mode (see page 36).

#### ⑦ LEVEL

Selects the speaker channel to be adjusted (see page 35).

**⑧ Cursor buttons  $\wedge/\vee/⟨/⟩$ , ENTER**

Select and adjust the sound field program parameters or the “SET MENU” parameters.

**⑨ RETURN**

Returns to the previous menu level when adjusting the “SET MENU” parameters.

**⑩ TRANSMIT indicator**

Flashes while the remote control is sending infrared signals.

**⑪ STANDBY**

Sets this unit to the standby mode (see page 26).

**⑫ POWER**

Turns on this unit (see page 26).

**⑬ SLEEP**

Sets the sleep timer (see page 34).

**⑭ MULTI CH IN**

Selects the component connected to the MULTI CH INPUT jacks as the input source when using an external decoder, etc. (see page 37).

**⑮ VOLUME +/-**

Increases or decreases the volume level.

**⑯ Component selector switch**

Selects the operation mode of the remote control buttons in the shaded area.

**AMP**

Operates this unit.

**SOURCE**

Operates the component selected with an input selector button (see page 87).

**TV**

Operates the TV assigned to either DTV/CBL or ☆☆ (see page 86).

**Notes**

- To set the remote control codes for other components, see page 88.
- When you set the remote control codes for both DTV/CBL and ☆☆ (see page 87), priority is given to the one set for DTV/CBL.

**⑰ MUTE**

Mutes the audio output. Press again to restore the audio output to the previous volume level (see page 32).

**⑱ STRAIGHT (EFFECT)**

Turns the sound field programs off or on. When “STRAIGHT” is selected, 2-channel or multi-channel input signals are output directly from their respective speakers without effect processing (see page 37).

**⑲ NIGHT**

Turns on or off the night listening modes (see page 32).

**⑳ SET MENU**

Enters “SET MENU” (see page 76).

■ **Controlling the TUNER functions**

Set the component selector switch to SOURCE and then press TUNER to select “TUNER” as the input source.

④ **Numeric buttons**

Use numbers 1 through 8 to select preset stations.

⑦ **BAND**

Switches the reception band between FM and AM (see page 44).

⑧ **A-ECAT. </>, PRESET/CH ^ / ∨**

Press A-ECAT. </> to select a preset station group (A to E) and PRESET/CH ^ / ∨ to select a preset station number (1 to 8) (see page 48).

■ **Using the remote control**

The remote control transmits a directional infrared ray. Be sure to aim the remote control directly at the remote control sensor on the main unit during operation.

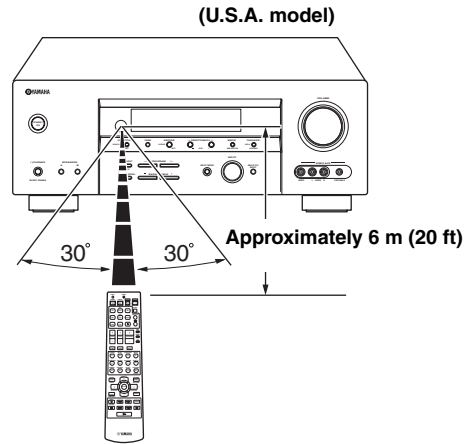

**Notes**

- Do not spill water or other liquids on the remote control.
- Do not drop the remote control.
- Do not leave or store the remote control in the following types of conditions:
  - places of high humidity, such as near a bath
  - places of high temperatures, such as near a heater or stove
  - places of extremely low temperatures
  - dusty places

## Front panel display

### Note

The XM is only applicable to the U.S.A. model and the cursor on the left of the XM indicator lights up only when “XM” is selected as the input source. For details, see “Basic XM Satellite Radio operations” on page 54.

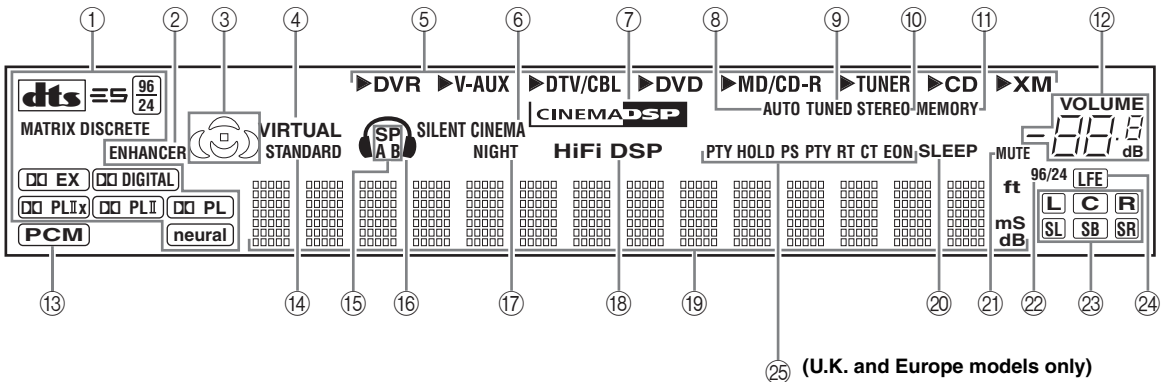

### ① Decoder indicators

The respective indicator lights up when any of the decoders of this unit function.

### Note

The neural indicator is only applicable to the U.S.A. and Canada models and lights up only when the Neural Surround decoder is selected (see page 41).

### ② ENHANCER indicator

Lights up when the Compressed Music Enhancer mode is turned on (see page 36).

### ③ Sound field indicators

Light up to indicate the active DSP sound fields.

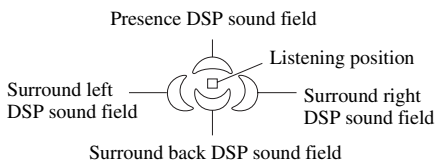

### ④ VIRTUAL indicator

Lights up when Virtual CINEMA DSP is active (see page 42).

### ⑤ Input source indicators

The corresponding cursor lights up to show the currently selected input source.

### ⑥ SILENT CINEMA indicator

Lights up when headphones are connected and a sound field program is selected (see page 32).

### ⑦ CINEMA DSP indicator

Lights up when you select a CINEMA DSP sound field program (see page 63).

### ⑧ AUTO indicator

Lights up when this unit is in the automatic tuning mode (see page 44).

### ⑨ TUNED indicator

Lights up when this unit is tuned into a station (see page 44).

### ⑩ STEREO indicator

Lights up when this unit is receiving a strong signal for an FM stereo broadcast while the AUTO indicator is lit (see page 44).

### ⑪ MEMORY indicator

Flashes to show that a station can be stored (see page 46).

### ⑫ VOLUME level indicator

Indicates the current volume level.

### ⑬ PCM indicator

Lights up when this unit is reproducing PCM (Pulse Code Modulation) digital audio signals.

### ⑭ STANDARD indicator

Lights up when the “SUR. STANDARD” or “SUR. ENHANCED” programs are selected (see page 41).

### ⑮ SP A B indicators

Light up according to the set of front speakers selected.

**⑩ Headphones indicator**

Lights up when headphones are connected (see page 32).

**⑪ NIGHT indicator**

Lights up when you select a night listening mode (see page 32).

**⑫ HiFi DSP indicator**

Lights up when you select a HiFi DSP sound field program (see page 63).

**⑬ Multi-information display**

Shows the name of the current sound field program and other information when adjusting or changing settings.

**⑭ SLEEP indicator**

Lights up while the sleep timer is on (see page 34).

**⑮ MUTE indicator**

Flashes while the MUTE function is on (see page 32).

**⑯ 96/24 indicator**

Lights up when a DTS 96/24 signal is input to this unit.

**⑰ Input channel indicators**

Indicate the channel components of the current digital input signal (see page 28).

**⑱ LFE indicator**

Lights up when the input signal contains the LFE signal.

**⑲ Radio Data System indicators  
(U.K. and Europe models only)**

Lights up when the Radio Data System data is being received.

**EON**

Lights up when the EON data service is being received.

**PTY HOLD**

Lights up while searching for the Radio Data System stations in the PTY SEEK mode.

## Rear panel

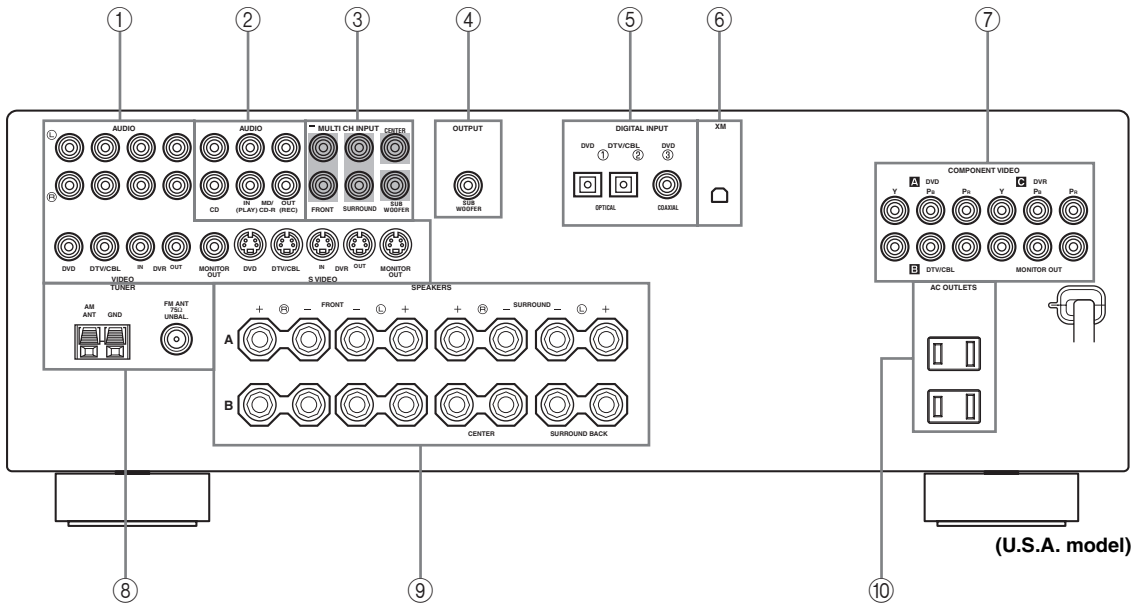

① **Video component jacks**

See pages 18 and 19 for connection information.

② **Audio component jacks**

See page 21 for connection information.

③ **MULTI CH INPUT jacks**

See page 22 for connection information.

④ **SUBWOOFER OUTPUT jack**

See page 14 for connection information.

⑤ **DIGITAL INPUT jacks**

See page 19 for connection information.

⑥ **XM jack (U.S.A. model only)**

See page 51 for connection information.

⑦ **COMPONENT VIDEO jacks**

See pages 18 and 19 for connection information.

⑧ **Antenna terminals**

See page 23 for connection information.

⑨ **Speaker terminals**

See page 13 for connection information.

⑩ **AC OUTLET(S)**

Use to supply power to your other audiovisual components.

See page 24 for details.

■ **VOLTAGE SELECTOR (Asia and General models only)**

See page 24 for details.

(U.S.A. model)

# CONNECTIONS

## Placing speakers

The speaker layout below shows the standard ITU-R\* speaker setting. You can use it to enjoy CINEMA DSP and multi-channel audio sources.

\* ITU-R is the radio communication sector of the ITU (International Telecommunication Union).

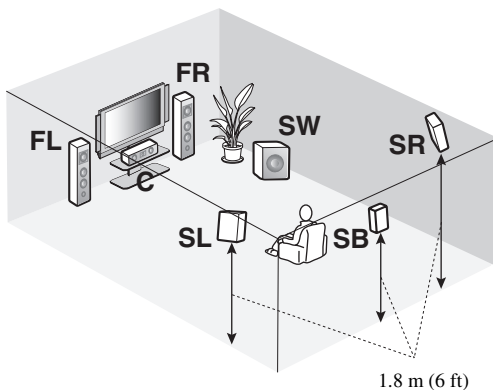
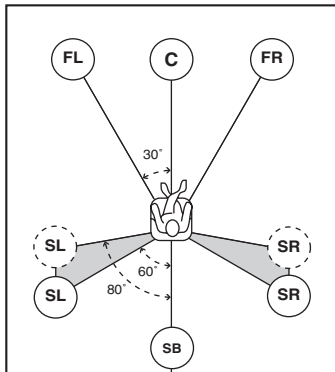

### Front speakers (FL and FR)

The front speakers are used for the main source sound plus effect sounds. Place these speakers at an equal distance from the ideal listening position. The distance of each speaker from each side of the video monitor should be the same.

### Center speaker (C)

The center speaker is for the center channel sounds (dialog, vocals, etc.). If for some reason it is not practical to use a center speaker, you can do without it. Best results, however, are obtained with the full system. Place the center speaker centrally between the front speakers and as close to the monitor as possible, such as directly over or under it.

### Surround speakers (SL and SR)

The surround speakers are used for effect and surround sounds. Place these speakers behind your listening position, facing slightly inwards, about 1.8 m (6 ft) above the floor.

### Surround back speaker (SB)

The surround back speaker supplements the surround speakers and provides more realistic front-to-back transitions. Place this speaker directly behind the listening position and at the same height as the surround speakers.

### Subwoofer (SW)

The use of a subwoofer with a built-in amplifier, such as the YAMAHA Active Servo Processing Subwoofer System, is effective not only for reinforcing bass frequencies from any or all channels, but also for hi-fi stereo reproduction of the LFE (low-frequency effect) channel included in Dolby Digital and DTS sources. The position of the subwoofer is not so critical, because low bass sounds are not highly directional. But it is better to place the subwoofer near the front speakers. Turn it slightly toward the center of the room to reduce wall reflections.



## Connecting speakers

Be sure to connect the left channel (L), right channel (R), “+” (red) and “-” (black) properly. If the connections are faulty, no sound will be heard from the speakers, and if the polarity of the speaker connections is incorrect, the sound will be unnatural and lack bass.

### CAUTION

- Before connecting the speakers, make sure that this unit is in the standby mode (see page 26).
- Do not let the bare speaker wires touch each other or do not let them touch any metal part of this unit. This could damage this unit and/or speakers.
- Use magnetically shielded speakers. If this type of speakers still creates the interference with the monitor, place the speakers away from the monitor.
- If you are to use 4 or 6 ohm speakers, be sure to set “SP IMP.” to “6ΩMIN” before using this unit (see page 25).

### Notes

- A speaker cord is actually a pair of insulated cables running side by side. Cables are colored or shaped differently, perhaps with a stripe, groove or ridge. Connect the striped (grooved, etc.) cable to the “+” (red) terminals of this unit and your speaker. Connect the plain cable to the “-” (black) terminals.
- The low-frequency signals of other speakers set to “SML” (or “SMALL”) or to “NONE” in “SPEAKER SET” (see pages 78 and 79) are directed to the speakers selected in “BASS OUT” (see page 79).

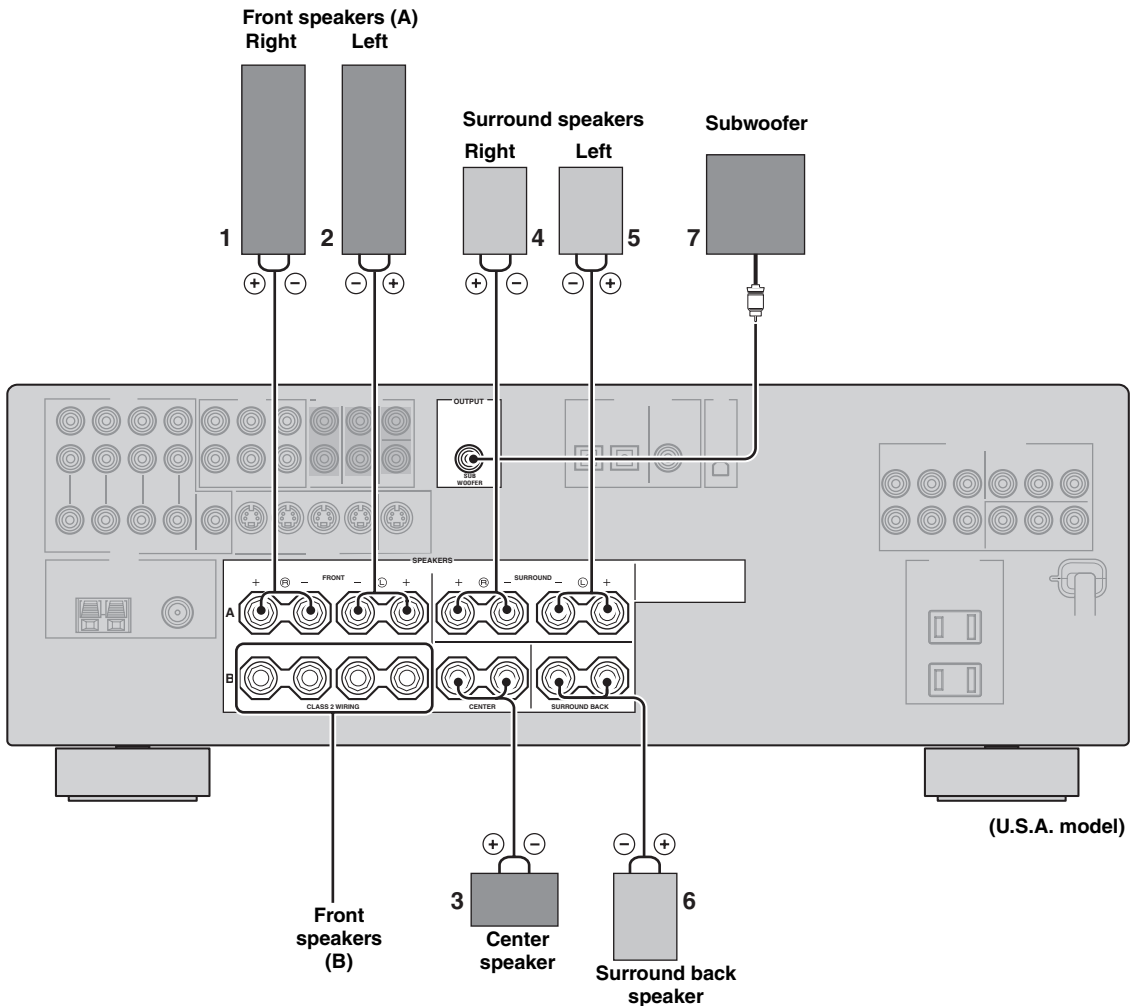

**FRONT terminals**

Connect one or two front speaker systems (1, 2) to these terminals. If you use only one front speaker system, connect it to the FRONT A or B terminal.

**CENTER terminals**

Connect a center speaker (3) to these terminals.

**SURROUND terminals**

Connect surround speakers (4, 5) to these terminals.

**SURROUND BACK terminals**

Connect a surround back speaker (6) to these terminals.

**SUBWOOFER jack**

Connect a subwoofer with a built-in amplifier (7) (such as the YAMAHA Active Servo Processing Subwoofer System) to this jack.

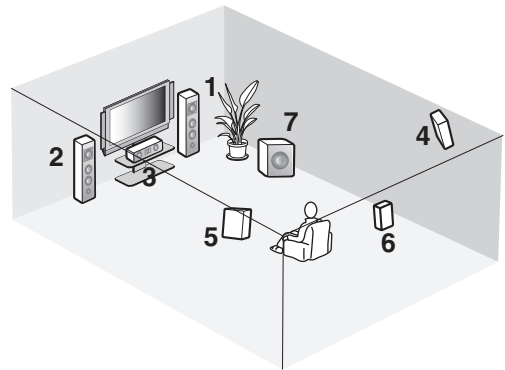

**Speaker layout**

■ Connecting the speaker cable

- 1 Remove approximately 10 mm (0.4 in) of insulation from the end of each speaker cable and then twist the exposed wires of the cable together to prevent short circuits.

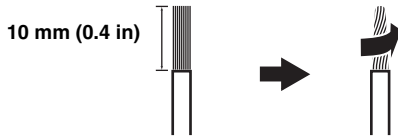

- 2 Loosen the knob.

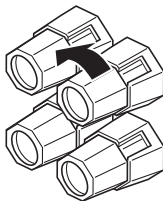

Red: positive (+)  
Black: negative (-)

- 3 Insert one bare wire into the hole on the side of each terminal.

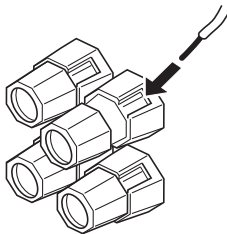

Red: positive (+)  
Black: negative (-)

- 4 Tighten the knob to secure the wire.

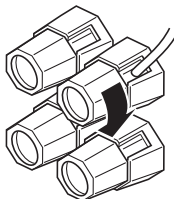

Red: positive (+)  
Black: negative (-)

■ Connecting the banana plug (except U.K., Europe and Asia models)

The banana plug is a single-pole electrical connector widely used to terminate speaker cables.

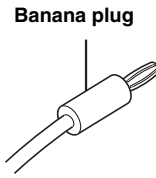

- 1 Tighten the knob.

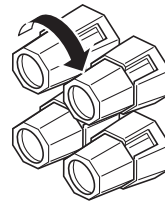

- 2 Insert the banana plug connector into the end of the corresponding terminal.

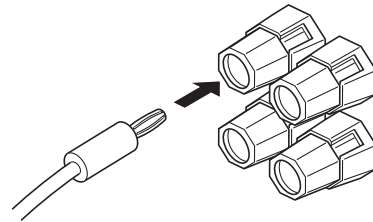

## Information on jacks and cable plugs

### Audio jacks and cables

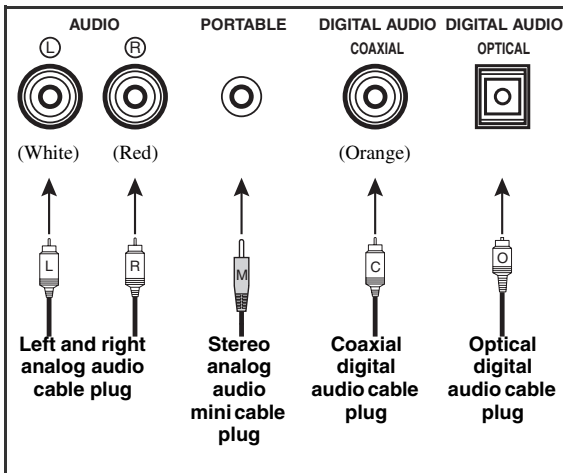

### Video jacks and cables

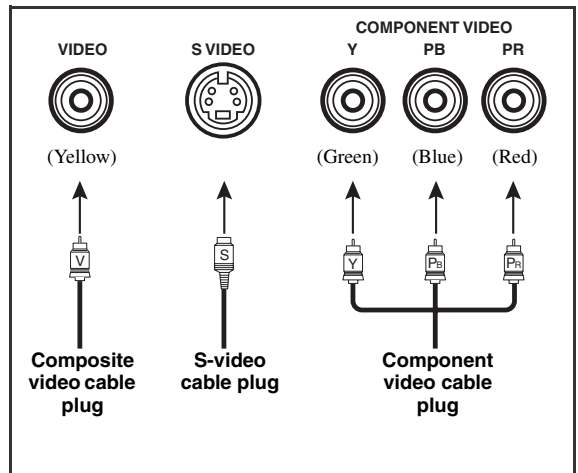

#### ■ Audio jacks

This unit has four types of audio jacks. Connection depends on the availability of audio jacks on your other components.

##### AUDIO jacks

For conventional analog audio signals transmitted via left and right analog audio cables. Connect red plugs to the right jacks and white plugs to the left jacks.

##### PORTABLE jack

For analog audio signals transmitted via stereo analog audio mini cables.

##### DIGITAL AUDIO COAXIAL jacks

For digital audio signals transmitted via coaxial digital audio cables.

##### DIGITAL AUDIO OPTICAL jacks

For digital audio signals transmitted via optical digital audio cables.

#### Notes

- You can use the digital jacks to input PCM, Dolby Digital and DTS bitstreams. When you connect components to both the COAXIAL and OPTICAL jacks, priority is given to the signals input at the COAXIAL jack. All digital input jacks are compatible with 96-kHz sampling digital signals.
- Pull out the cap from the optical jack before you connect the fiber optic cable. Do not discard the cap. When you are not using the optical jack, be sure to put the cap back in place. This cap protects the jack from dust.

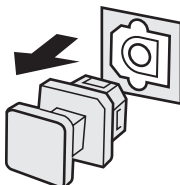

#### ■ Video jacks

This unit has three types of video jacks. Connection depends on the availability of input jacks on your video monitor.

##### VIDEO jacks

For conventional composite video signals transmitted via composite video cables.

##### S VIDEO jacks

For S-video signals, separated into the luminance (Y) and chrominance (C) video signals transmitted on separate wires of S-video cables.

##### COMPONENT VIDEO jacks

For component video signals, separated into the luminance (Y) and chrominance (PB, PR) video signals transmitted on separate wires of component video cables.

## Audio and video signal flow

### ■ Audio signal flow for AUDIO OUT (REC)

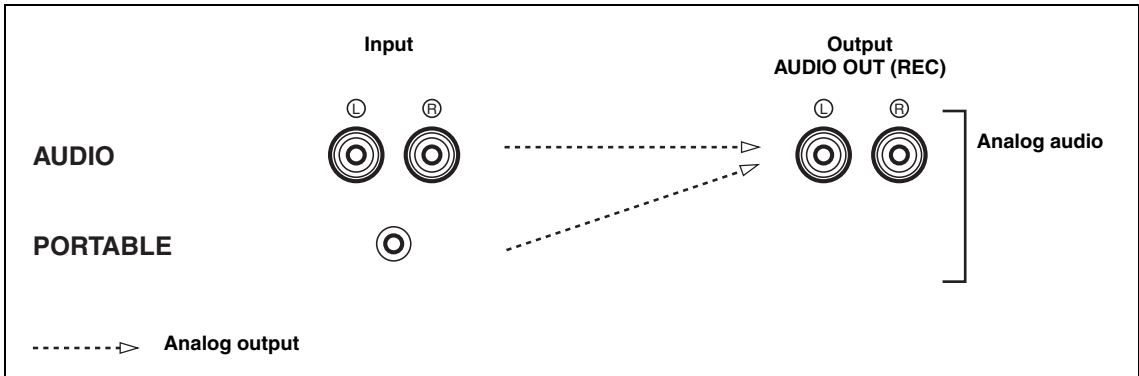

#### Note

This unit handles digital and analog signals independently. Thus, audio signals input at the analog jacks are output only at the analog AUDIO OUT (REC) jacks.

### ■ Video signal flow for MONITOR OUT

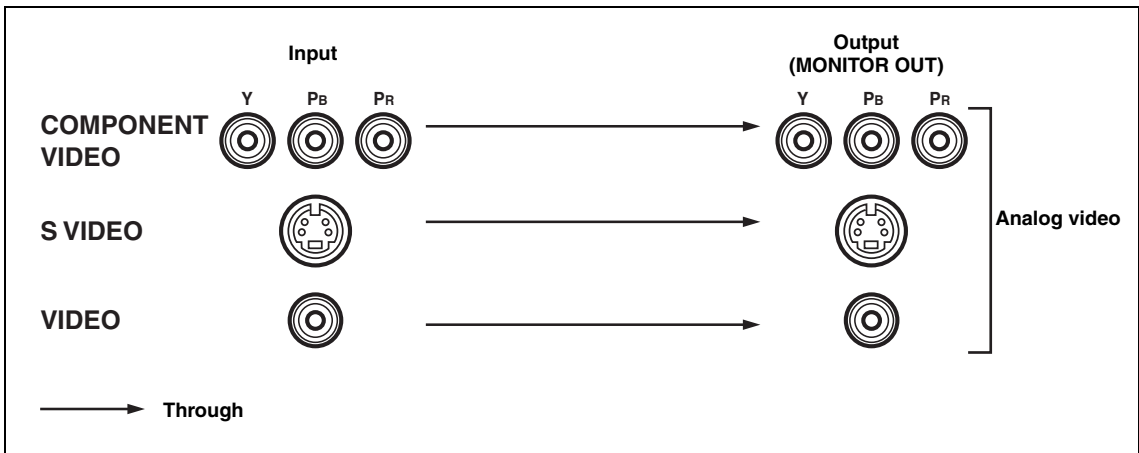

## Connecting a TV

Connect your TV to the VIDEO MONITOR OUT jack, the S VIDEO MONITOR OUT jack or the COMPONENT VIDEO MONITOR OUT jacks of this unit.

### CAUTION

Do not connect this unit or other components to the AC power supply until all connections between components are complete.

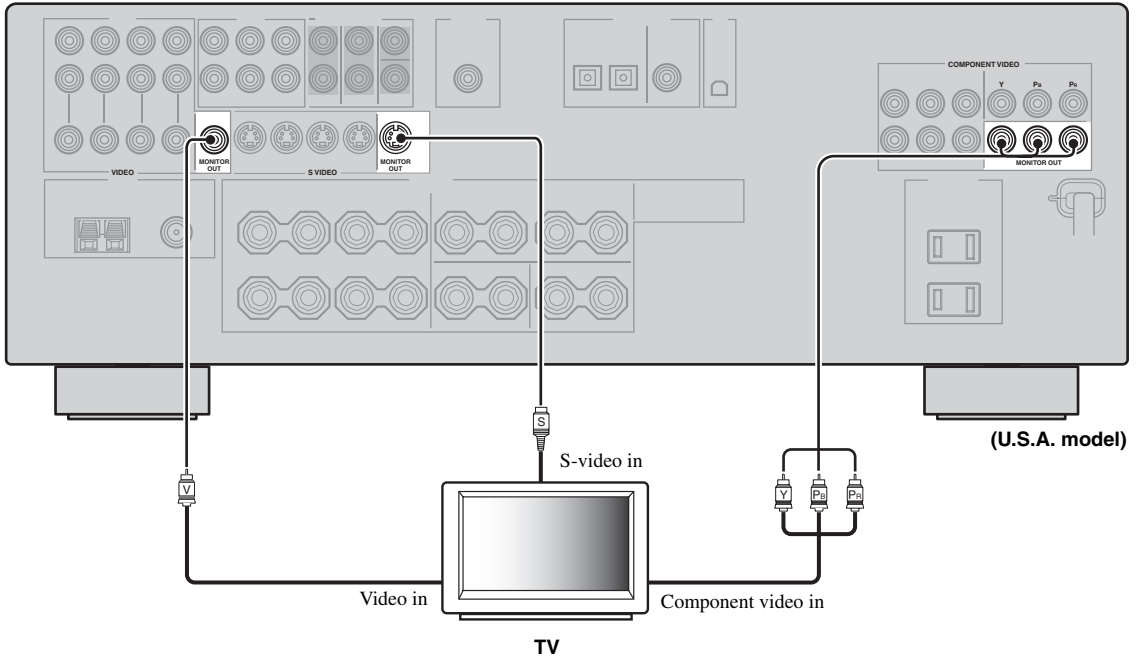

## Connecting a DVD player, a DVD recorder, a VCR or an STB

Connect your DVD player, DVD recorder, VCR or STB (set-top box) using the same type of video connections as those made for your TV (see page 18). The cable TV receiver and the satellite receiver are examples of the STB.

### CAUTION

**Do not connect this unit or other components to the AC power supply until all connections between components are complete.**

### Notes

- Be sure to make the same type of video connections as those made for your TV (see page 18). For example, if you connected your TV to the VIDEO MONITOR OUT jack of this unit, connect your other components to the VIDEO jacks.
- To make a digital connection to a component other than the default component assigned to each DIGITAL INPUT jack, select the corresponding setting for "OPTICAL IN", or "COAXIAL IN" in "INPUT ASSIGN" (see page 81).
- If you connect your DVD player to both the DIGITAL INPUT (OPTICAL) and the DIGITAL INPUT (COAXIAL) jacks, priority is given to the signals input at the DIGITAL INPUT (COAXIAL) jack

### ■ Connecting a DVD player

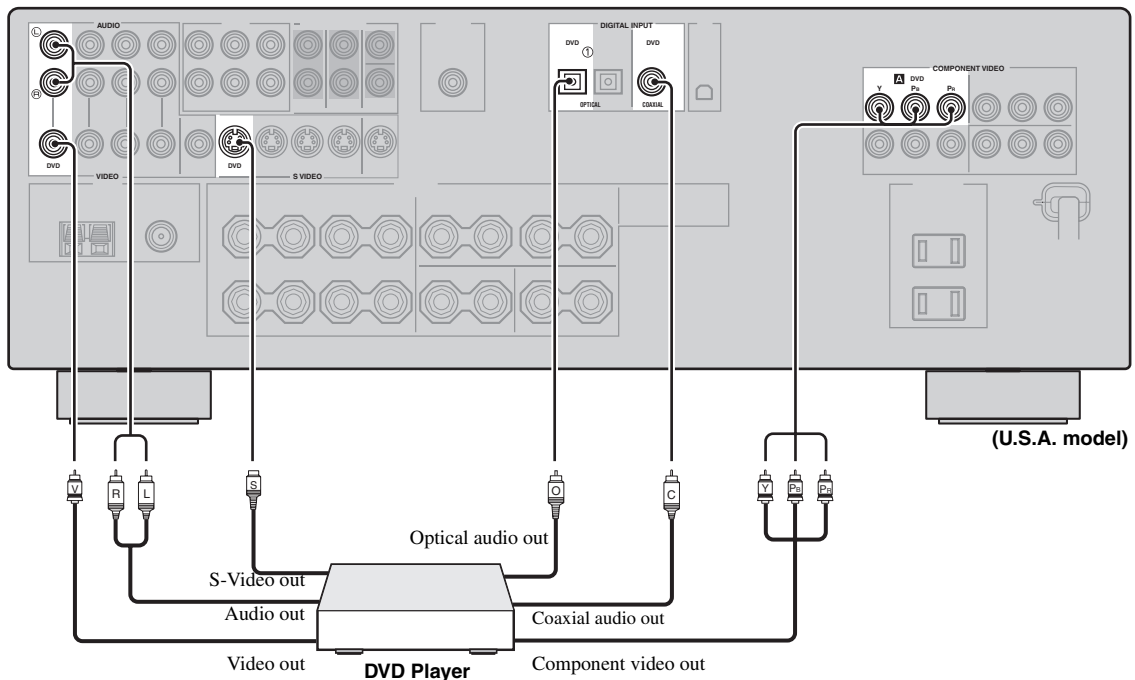

■ Connecting a DVD recorder or a VCR

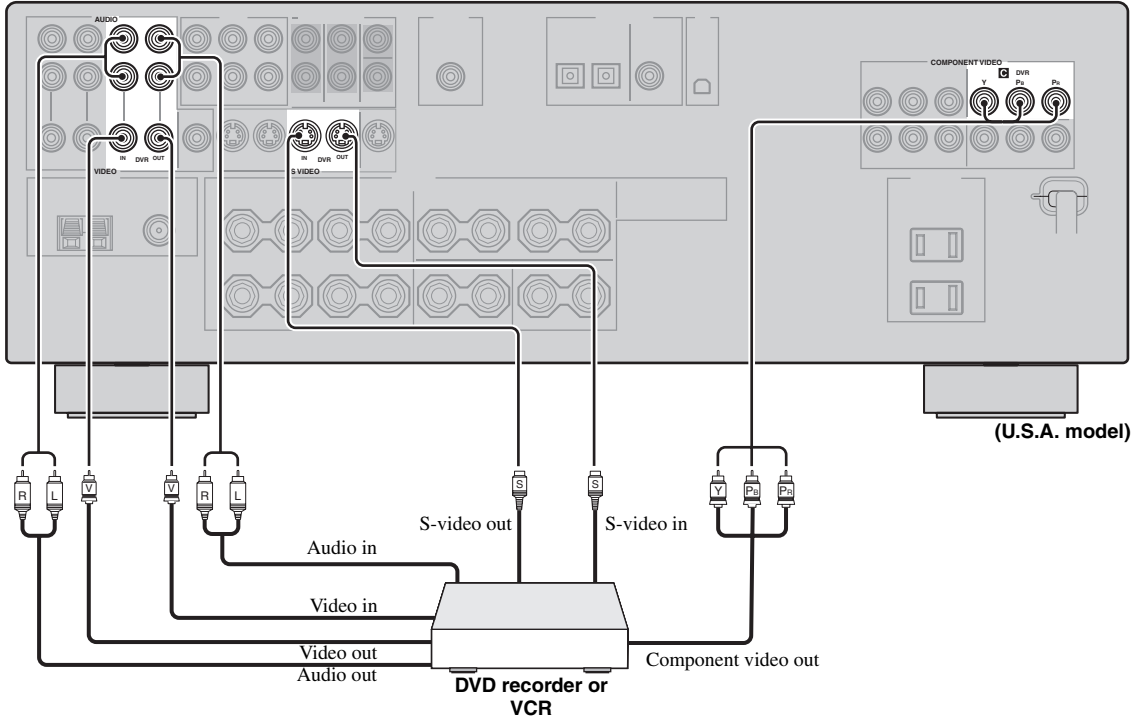

■ Connecting an STB

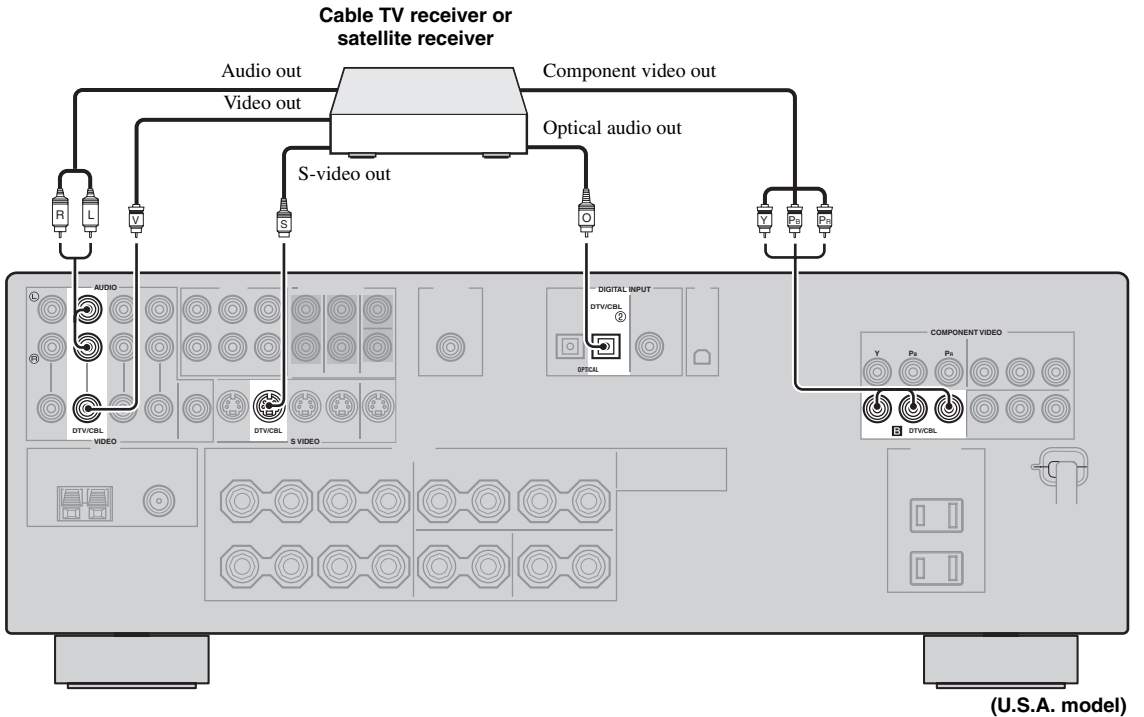



## Connecting a CD player, an MD player or a tape deck

Connect your CD player, MD player or tape deck via analog connection.

### CAUTION

**Do not connect this unit or other components to the AC power supply until all connections between components are complete.**

### Note

To make a digital connection to a component other than the default component assigned to each DIGITAL INPUT jack, select the corresponding setting for "OPTICAL IN" or "COAXIAL IN" in "INPUT ASSIGN" (see page 81).

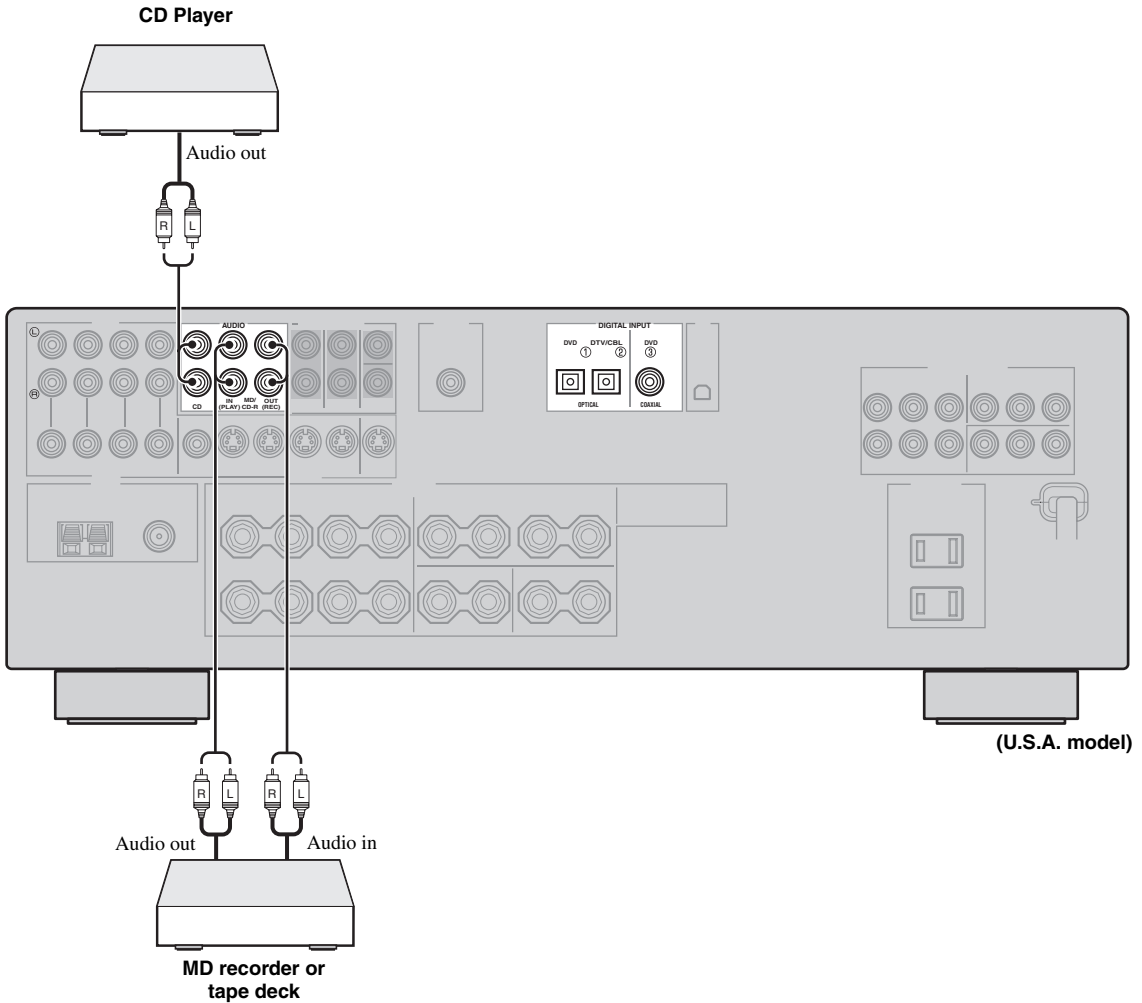

## Connecting a multi-format player or an external decoder

This unit is equipped with 6 additional input jacks (FRONT L/R, CENTER, SURROUND L/R and SUBWOOFER) for discrete multi-channel input from a multi-format player, external decoder, sound processor or pre-amplifier. Connect the output jacks on your multi-format player or external decoder to the MULTI CH INPUT jacks. Be sure to match the left and right output jacks to the left and right input jacks for the front and surround channels.

### CAUTION

**Do not connect this unit or other components to the AC power supply until all connections between components are complete.**

### Notes

- When you select the component connected to the MULTI CH INPUT jacks as the input source (see page 37), this unit automatically turns off the digital sound field processor, and you cannot select sound field programs.
- This unit does not redirect signals input at the MULTI CH INPUT jacks to accommodate for missing speakers. We recommend that you connect at least a 5.1-channel speaker system before using this feature.
- When headphones are used, signals are output only from the front left and right channels.

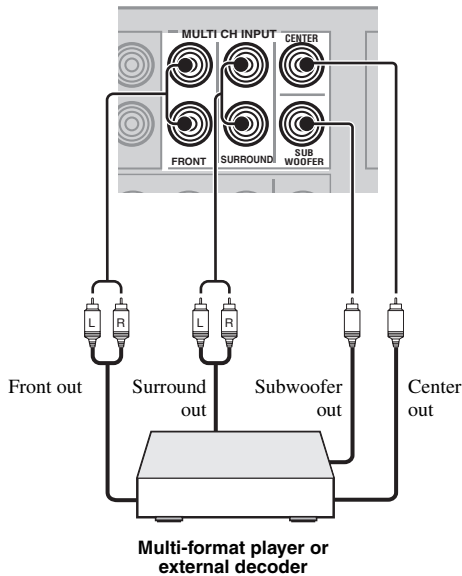

## Connecting a game console, a video camera or a portable audio player

Use the VIDEO AUX jacks on the front panel to connect a game console, a video camera or a portable audio player to this unit.

### CAUTION

**Be sure to turn off the volume of this unit and other components before making connections.**

### Note

The audio signals input at the PORTABLE mini jack take priority over the ones input at the AUDIO L/R jacks.

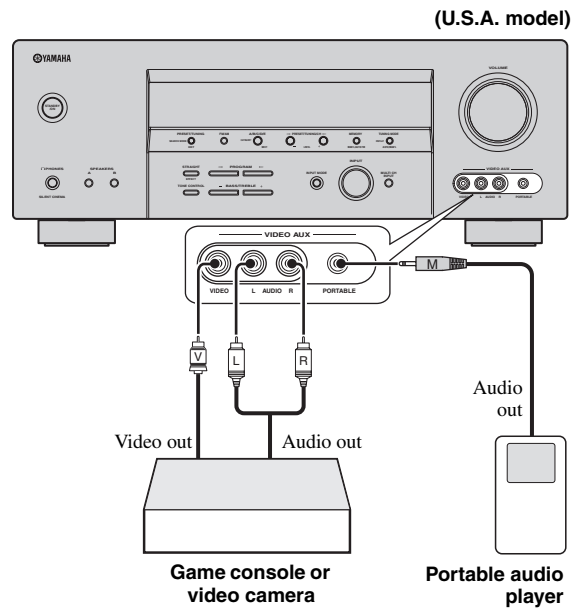

## Connecting the FM and AM antennas

Both FM and AM indoor antennas are supplied with this unit. In general, these antennas should provide sufficient signal strength. Connect each antenna correctly to designated terminals.

### Notes

- Be sure to set the tuner frequency step (Asia and General models only) according to the frequency spacing in your area (see page 85).
- The AM loop antenna should be placed away from this unit.
- The AM loop antenna should always be connected, even if an outdoor AM antenna is connected to this unit.
- A properly installed outdoor antenna provides clearer reception than an indoor one. If you experience poor reception quality, install an outdoor antenna. Consult the nearest authorized YAMAHA dealer or service center about outdoor antennas.

### AM loop antenna (supplied)

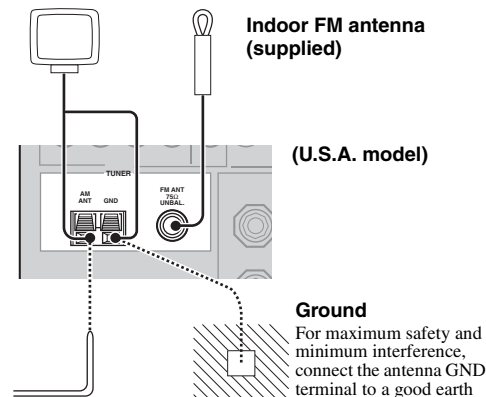

**Outdoor AM antenna**  
Use a 5 to 10 m (16.4 to 32.8 ft) of vinyl-covered wire extended outdoors from a window.

### ■ Connecting the AM loop antenna

#### 1 Set up the AM loop antenna.

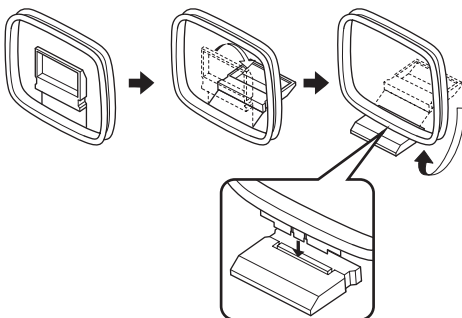

#### 2 Press and hold the tab of the AM ANT terminal.



#### 3 Insert one of the AM loop antenna lead wires into the AM ANT terminal.

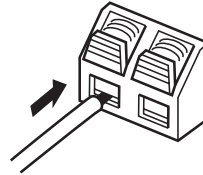

#### 4 Release the tab of the AM ANT terminal back into place.



#### 5 Repeat steps 2 through 4 to connect the other lead wire to the GND terminal.



Once you have properly connected the AM loop antenna to this unit, orient the AM loop antenna for the best reception when you tune into AM stations (see page 44).

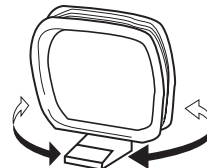

## Connecting the power cable

Once all connections are complete, plug the power cable into the AC wall outlet.

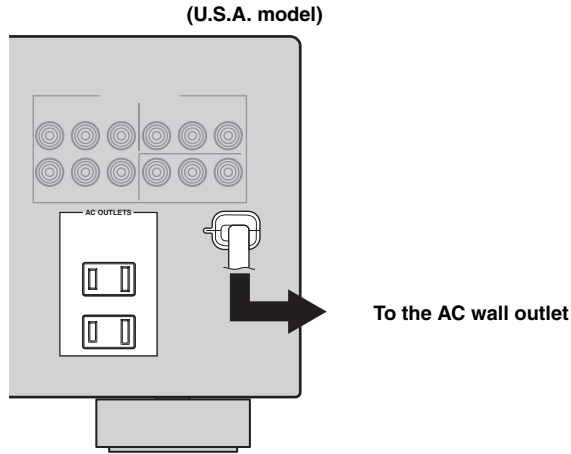

### CAUTION

#### VOLTAGE SELECTOR (Asia and General models only)

The VOLTAGE SELECTOR on the rear panel of this unit must be set for your local voltage BEFORE plugging the power cable into the AC wall outlet. Improper setting of the VOLTAGE SELECTOR may cause damage to this unit and create a potential fire hazard.

**Rotate the VOLTAGE SELECTOR clockwise or counterclockwise to the correct position using a straight slot screwdriver.**

Voltages are as follows:

Asia model ..... 220/230–240 V AC, 50/60 Hz  
 General model ..... 110/120/220/230–240 V AC, 50/60 Hz

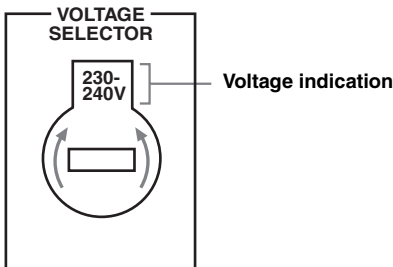

#### AC OUTLET(S) (SWITCHED)

U.K. and Australia models..... 1 outlet  
 Korea model..... None  
 Other models..... 2 outlets

Use these outlet(s) to supply power to any connected components. Connect the power cable of your other components to these outlet(s). Power to these outlet(s) is supplied when this unit is turned on. However, power to these outlet(s) is cut off when this unit is in the standby mode or the power cable of this unit is disconnected from the AC wall outlet. For information on the maximum power or the total power consumption of the components that can be connected to these outlet(s), see “SPECIFICATIONS” on page 100.

#### Memory back-up

The memory back-up circuit prevents the stored data from being lost even if this unit is in the standby mode. However, the stored data will be lost in case the power cable is disconnected from the AC wall outlet or if the power supply is cut off for more than one week.

## Setting the speaker impedance

### CAUTION

If you are to use 4 or 6 ohm speakers, set “SP IMP.” to “6ΩMIN” as follows BEFORE using this unit.

(U.S.A. model)

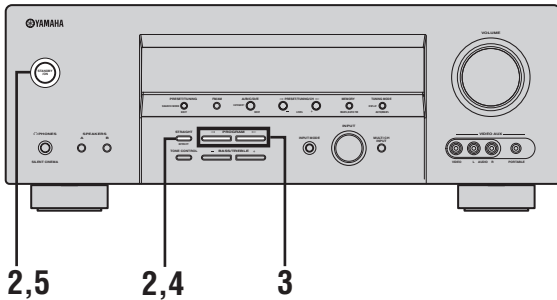

- 1 Make sure this unit is set to the standby mode.

See page 26 for details about turning on this unit or standby mode.

- 2 Press and hold STRAIGHT (EFFECT) on the front panel and then press STANDBY/ON to turn on this unit.

This unit turns on, and the advanced setup menu appears in the front panel display.



- 3 Press PROGRAM </> buttons on the front panel to select “SP IMP.”.

The following display appears in the front panel display.

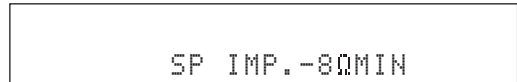

- 4 Press STRAIGHT (EFFECT) on the front panel repeatedly to select “6ΩMIN”.

The following display appears in the front panel display.

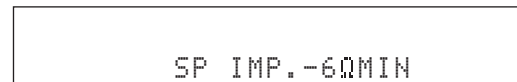

- 5 Press STANDBY/ON on the front panel to save the new setting and set this unit to the standby mode.



### Note

The setting you made is reflected next time you turn on this unit.

## Turning on this unit or setting it to the standby mode

When all connections are complete, turn on this unit.

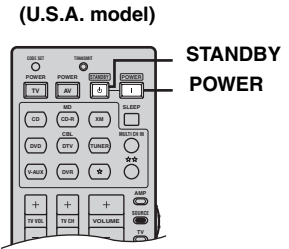
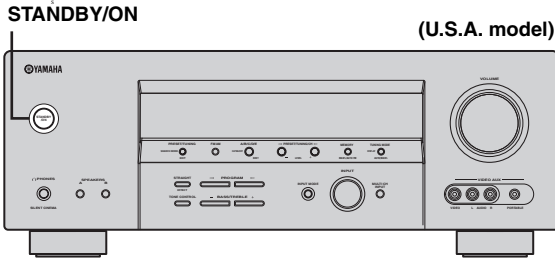

### ■ Turning on the power

Press STANDBY/ON on the front panel (or POWER on the remote control) to turn on this unit.



Front panel

or



Remote control

### ■ Setting this unit to the standby mode

Press STANDBY/ON on the front panel again (or STANDBY on the remote control) to set this unit to the standby mode.



Front panel

or



Remote control

# BASIC SETUP

The “BASIC SETUP” feature is a useful way to set up your system quickly and with minimal effort.

## Notes

- Make sure you disconnect your headphones from this unit.
- If you wish to configure this unit manually using more precise adjustments, use the detailed parameters in “SOUND MENU” (see page 78).
- Altering any parameters in “BASIC SETUP” resets all parameters manually adjusted in “SOUND MENU” (see page 78).
- Initial settings are indicated in bold under each parameter.
- Press RETURN on the remote control to return to the previous menu level.

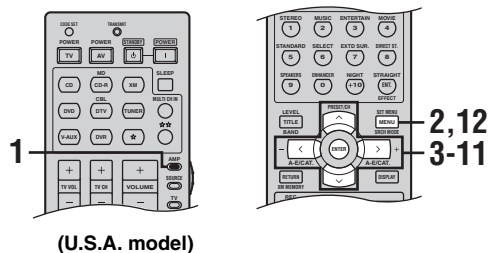

(U.S.A. model)

### 3 Press ENTER to enter “BASIC SETUP”.

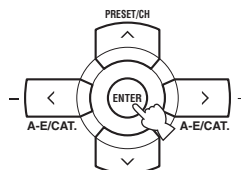

The “ROOM” appears in the front panel display.

### 1 Set the component selector switch to AMP.

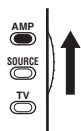

### 4 Press </> to select the desired setting.

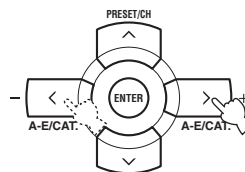

### 2 Press SET MENU.

“BASIC SETUP” appears in the front panel display.



➔ « BASIC SETUP

ROOM: S >M L

Select the size of the room where you have installed your speakers. In general, the room sizes are defined as follows:

Choices: S, **M**, L

[U.S.A. and Canada models]

S (small) 16 x 13ft, 200ft<sup>2</sup> (4.8 x 4.0m, 20m<sup>2</sup>)

M (medium) 20 x 16ft, 300ft<sup>2</sup> (6.3 x 5.0m, 30m<sup>2</sup>)

L (large) 26 x 19ft, 450ft<sup>2</sup> (7.9 x 5.8m, 45m<sup>2</sup>)

[Other models]

S (small) 3.6 x 2.8m, 10m<sup>2</sup>

M (medium) 4.8 x 4.0m, 20m<sup>2</sup>

L (large) 6.3 x 5.0m, 30m<sup>2</sup>

**5** Press  $\downarrow$  to select “SUBWOOFER” and then  $\langle / \rangle$  to select the desired setting.

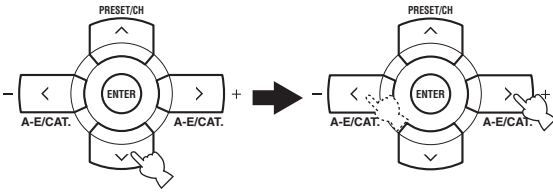

SUBWOOFER • YES

Choices: **YES**, NONE

- Select “YES” if you have a subwoofer in your system.
- Select “NONE” if you do not have a subwoofer in your system.

**6** Press  $\downarrow$  to select “SPEAKERS” and then  $\langle / \rangle$  to select the number of speakers connected to this unit.

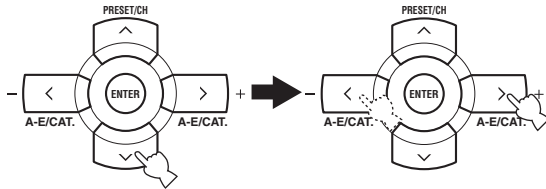

SPEAKERS • 6spk

Choice	Display	Speakers
2spk	<b>L</b> <b>R</b>	Front L/R
3spk	<b>L</b> <b>C</b> <b>R</b>	Front L/R, Center
4spk	<b>L</b> <b>R</b> <b>SL</b> <b>SR</b>	Front L/R, Surround L/R
5spk	<b>L</b> <b>C</b> <b>R</b> <b>SL</b> <b>SR</b>	Front L/R, Center, Surround L/R
6spk	<b>L</b> <b>C</b> <b>R</b> <b>SL</b> <b>SB</b> <b>SR</b>	Front L/R, Center, Surround L/R, Surround back

**7** Press  $\downarrow$  once and then  $\langle / \rangle$  to select the desired setting.

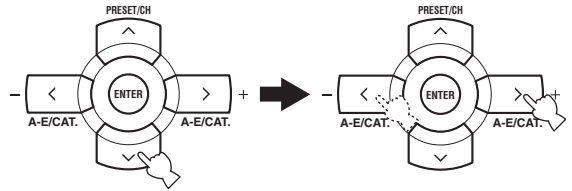

>SET CANCEL

Choices: **SET**, CANCEL

- Select “SET” to apply the settings you made.
- Select “CANCEL” to cancel the setup procedure without making any changes.



You can also press SET MENU to cancel the setup procedure.

**8** Press **ENTER** to confirm your selection.

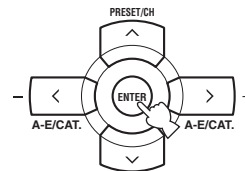

If you selected “SET” in step 7, each speaker outputs a test tone twice in turn. “CHECK:TestTone” appears in the front panel display for a few seconds and then “CHECK OK?” appears in the front panel display.

CHECK:TestTone



Check the speaker connections (see page 13) and adjust the “SPEAKERS” settings back in step 6, if necessary.



**9 Press </> to select the desired setting.**

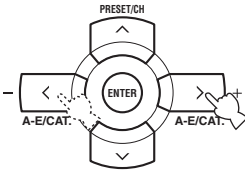

CHECK OK? . . YES

Choices: **YES**, NO

- Select “YES” to complete the setup procedure if the test tone levels from each speaker were satisfactory.
- Select “NO” to proceed to the speaker level adjustment menu to balance the output level of each speaker.

**10 Press ENTER to confirm your selection.**

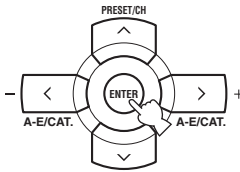

- If you selected “YES” in step 9, the setup procedure is completed and the display returns to the top “SET MENU” display.
- If you selected “NO” in step 9, the front speaker level adjustment display appears in the front panel display.

**11 Press ∨/∧ to select a speaker and then </> to adjust the balance.**

The selected speaker and the front left speaker or the surround left speaker output a test tone in turn.

- Press > to increase the value.
- Press < to decrease the value.

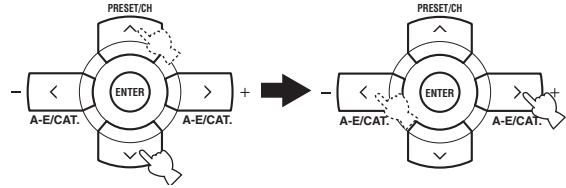

FR -----|-----

- Select “FR” to adjust the balance between the front left and right speakers.
- Select “C” to adjust the balance between the front left and center speakers.
- Select “SL” to adjust the balance between the front left and surround left speakers.
- Select “SB” to adjust the balance between the surround left and surround back speakers.
- Select “SR” to adjust the balance between the surround left and surround right speakers.
- Select “SWFR” to adjust the balance between the front left speaker and the subwoofer.

**12 Press SET MENU to exit from “BASIC SETUP”.**



# PLAYBACK

## CAUTION

Extreme caution should be exercised when you play back CDs encoded in DTS. If you play back a CD encoded in DTS on a DTS-incompatible CD player, you will only hear some unwanted noise that may damage your speakers. Check whether your CD player supports CDs encoded in DTS. Also, check the sound output level of your CD player before you play back a CD encoded in DTS.

(U.S.A. model)

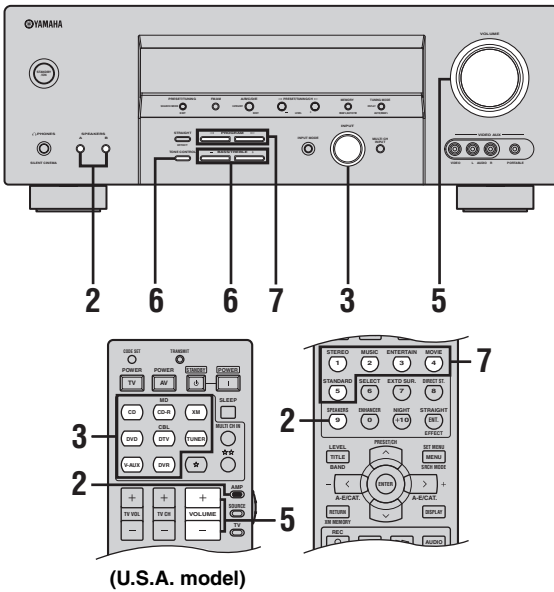

(U.S.A. model)

**1** Turn on the video monitor connected to this unit.

**2** Press **SPEAKERS A** or **B** on the front panel (or set the component selector switch to **AMP** and then press **SPEAKERS** on the remote control repeatedly).

Each time you press **SPEAKERS A** or **B** on the front panel, the respective speakers are turned on or off.

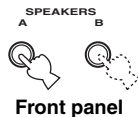

Front panel

or



Remote control

**3** Rotate the **INPUT** selector on the front panel (or press one of the input selector buttons on the remote control) to select the desired input source.

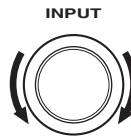

Front panel

or

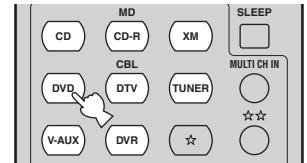

Remote control

The name of the currently selected input source appears in the front panel display for a few seconds.

Available input sources

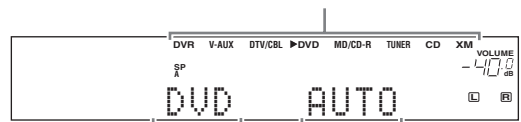

Currently selected input source

Currently selected input mode

## Notes

- If you are to select an input source connected via digital connections, set "INPUT MODE" to "AUTO" or "DTS" (see page 33).
- For details about controlling XM Satellite Radio when "XM" is selected as the input source, see page 54.

**4** Start playback on the selected source component or select a broadcast station.

Refer to the operating instructions for the source component.

See page 44 for details about tuning instructions.

- 5 Rotate **VOLUME** on the front panel (or press **VOLUME +/-** on the remote control) to adjust the volume to the desired output level.

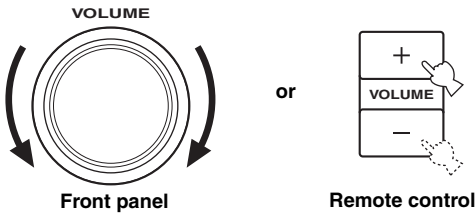

- 6 Press **TONE CONTROL** on the front panel repeatedly to select “**TREBLE**” or “**BASS**” and then press **BASS/TREBLE +/-** buttons to adjust the corresponding frequency response level.

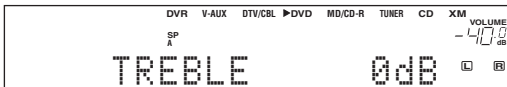
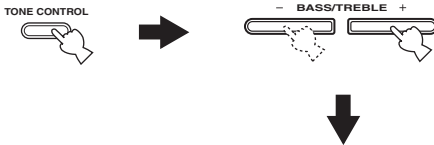

- Select “**TREBLE**” to adjust the high-frequency response.
- Select “**BASS**” to adjust the low-frequency response.

#### Notes

- Speaker and headphone adjustments are stored independently.
- When “**TC.BYPASS**” is set to “**AUTO**” (see page 81), and “**BASS**” and “**TREBLE**” are set to 0 dB, audio output automatically bypasses the tone control circuitry of this unit.
- If you increase or decrease the high-frequency or low-frequency sound to an extreme level, the tonal quality of the surround speakers may not match that of the front left and right speakers.
- **TONE CONTROL** is not effective when the “**DIRECT STEREO**” mode (see page 38) is selected or when “**MULTI CH INPUT**” (see page 37) is selected as the input source.
- To enjoy multi-channel sources in surround, see page 40 for details.

- 7 Press **PROGRAM** ◀/▶ buttons on the front panel (or press one of the sound field program selector buttons on the remote control repeatedly) to select the desired sound field program.

The name of the selected sound field program appears in the front panel display.

See page 63 for details about sound field programs.

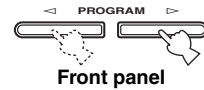

or

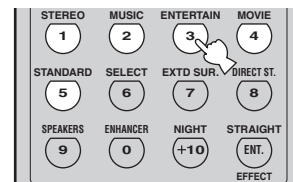

Remote control



Currently selected surround field program

#### Notes

- Choose a sound field program based on your listening preference, not merely on the name of the program.
- When you select an input source, this unit automatically selects the last sound field program used with the corresponding input source.
- Sound field programs cannot be selected when the component connected to the **MULTI CH INPUT** jacks is selected as the input source (see page 37).
- Sampling frequencies higher than 48 kHz (except for DTS 96/24 signals) are sampled down to 48 kHz and then sound field programs are applied.
- To display information about the currently selected input source in the front panel display, see page 38 for details.

# USING OTHER FEATURES

## Using SILENT CINEMA

SILENT CINEMA allows you to enjoy multi-channel music or movie sound, including Dolby Digital and DTS sources, through ordinary headphones. SILENT CINEMA activates automatically whenever you connect headphones to the PHONES jack while listening to CINEMA DSP or HiFi DSP sound field programs (see page 63). When activated, the SILENT CINEMA indicator lights up in the front panel display.

### Notes

- SILENT CINEMA does not activate when “MULTI CH INPUT” is selected as the input source (see page 37).
- SILENT CINEMA is not effective when the “DIRECT STEREO” (see page 38) or “2ch Stereo” mode (see page 37) is selected, or when this unit is in the “STRAIGHT” mode (see page 37).

## Muting the audio output

Press **MUTE** on the remote control to mute the audio output. Press **MUTE** again to resume the audio output.



- You can also rotate VOLUME on the front panel or VOLUME +/- on the remote control to resume the audio output.
- You can adjust the muting level by using the “MUTING TYP.” parameter in “SOUND MENU” (see page 81).
- The MUTE indicator flashes in the front panel display when the audio output is muted and disappears from the front panel display when the audio output is resumed.

### Note

If you change the input source or the sound field program while the audio output is being muted, this unit resumes the audio output.

## Selecting the night listening mode

The night listening modes are designed to improve listenability at lower volumes or at night. Choose either “NIGHT:CINEMA” or “NIGHT:MUSIC” depending on the type of material you are playing.

- 1 Set the component selector switch to **AMP** and then press **NIGHT** on the remote control repeatedly to select “NIGHT:CINEMA” or “NIGHT:MUSIC”.

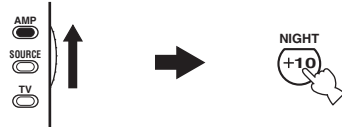

Choices: NIGHT:CINEMA, NIGHT:MUSIC, OFF

- Select “NIGHT:CINEMA” when watching films to reduce the dynamic range of film soundtracks and make dialog easier to hear at lower volumes.
- Select “NIGHT:MUSIC” when listening to music sources to preserve ease-of-listening for all sounds.
- Select “OFF” if you do not want to use this feature.



When a night listening mode is selected, the NIGHT indicator lights up in the front panel display.

- 2 Press **</>** on the remote control to adjust the effect level while “NIGHT:CINEMA” or “NIGHT:MUSIC” is displayed in the front panel display.

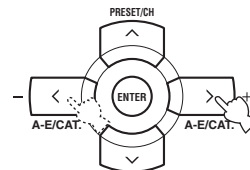

Remote control



Effect.Lvl:MID

Choices: MIN, MID, MAX

- Select “MIN” for minimum compression.
- Select “MID” for standard compression.
- Select “MAX” for maximum compression.



“NIGHT:CINEMA” and “NIGHT:MUSIC” adjustments are stored independently.

**Notes**

- You cannot use the night listening modes when the “DIRECT STEREO” program (see page 38) is selected or when the component connected to the MULTI CH INPUT jacks is selected as the input source (see page 37) even though the NIGHT indicator lights up when “DIRECT STEREO” is selected.
- The night listening modes may vary in effectiveness depending on the input source and surround sound settings you use.

**Selecting the input mode**

This unit comes with a variety of input jacks. Do the following to select the type of input signals you want to use.



You can adjust the default input mode of this unit by using the “INPUT MODE” parameter in “INPUT MENU” (see page 82).

**Notes**

- To play DTS-encoded DVDs and CDs, (when using a digital audio connection, be sure to set “INPUT MODE” to “DTS”.
- If the digital output data of the player has been processed in any way, you may not be able to perform DTS decoding depending on the player even if you make a digital connection between this unit and the player.

**1 Rotate the INPUT selector on the front panel to select the desired input source.**

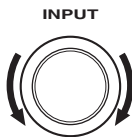

**2 Press INPUT MODE on the front panel repeatedly to select the desired input mode.**

INPUT MODE



Available input sources

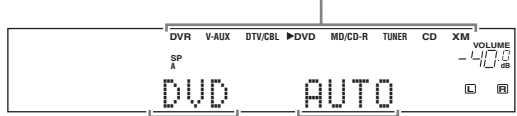

Currently selected input source

Currently selected input mode

AUTO

Automatically selects input signals in the following order:

- 1) Digital signals
- 2) Analog signals

DTS

Selects only digital signals encoded in DTS. If no DTS signals are input, no sound is output.

ANALOG

Selects only analog signals. If no analog signals are input, no sound is output.

**Notes**

- When “INPUT MODE” is set to “AUTO”, this unit automatically switches to the appropriate decoder if a Dolby Digital or DTS signal is detected.
- We recommend setting “INPUT MODE” to “AUTO” in most cases.

## Using the sleep timer

Use this feature to automatically set this unit to the standby mode after a certain amount of time. The sleep timer is useful when you are going to sleep while this unit is playing or recording a source. The sleep timer also automatically turns off any external components connected to AC OUTLET(S) (see page 24).

- 1 Press one of the input selector buttons on the remote control to select the desired input source.

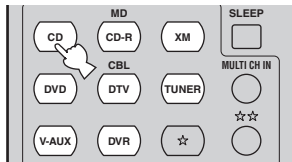

- 2 Start playback on the selected source component or select a broadcast station.

Refer to the operating instructions for the source component.

See page 44 for details about tuning instructions.

- 3 Press SLEEP on the remote control repeatedly to set the amount of time.

Each time you press SLEEP, the front panel display changes as shown below.

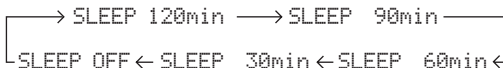

The SLEEP indicator flashes while you are switching the amount of time for the sleep timer. Once the sleep timer is set, the SLEEP indicator lights up in the front panel display, and the display returns to the selected sound field program.

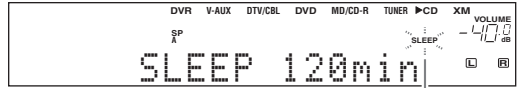

Flashes



Lights up

- 4 To cancel the sleep timer, press SLEEP on the remote control repeatedly until "SLEEP OFF" appears in the front panel display.



The SLEEP indicator turns off, and "SLEEP OFF" disappears from the front panel display after a few seconds.



The sleep timer setting can also be canceled by pressing STANDBY on the remote control (or STANDBY/ON on the front panel) to set this unit to the standby mode.

## Adjusting the speaker level

You can adjust the output level of each speaker while listening to a music source. This is also possible when playing sources input at the MULTI CH INPUT jacks.

### Note

This operation will override the level adjustments made in “BASIC SETUP” (see page 27) and “SP LEVEL” (see page 79).



This operation can also be performed using the control buttons on the front panel. Press NEXT on the front panel repeatedly to select the speaker channel whose output level you want to adjust and then press LEVEL +/- on the front panel to adjust the output level.

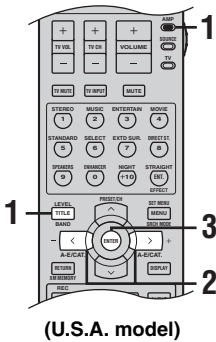

- 1 Set the component selector switch to AMP and then press LEVEL on the remote control repeatedly to select the speaker you want to adjust.

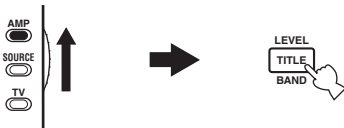

- Select “FRONT L” to adjust the front left speaker output level.
- Select “CENTER” to adjust the center speaker output level.
- Select “FRONT R” to adjust the front right speaker output level.
- Select “SUR. R” to adjust the surround right speaker output level.
- Select “SUR. B” to adjust the surround back speaker output level.
- Select “SUR. L” to adjust the surround left speaker output level.
- Select “SWFR” to adjust the subwoofer output level.



Once you press LEVEL on the remote control, you can also select the speaker by pressing ^ / v.

- 2 Press </> on the remote control to adjust the speaker output level.

- Press > to increase the value.
- Press < to decrease the value.

Control range: -10 dB to +10 dB

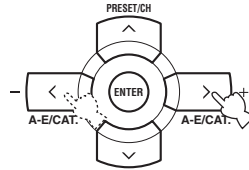

- 3 Press ENTER on the remote control when you have completed your adjustment.

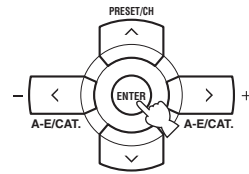

## Selecting the Compressed Music Enhancer mode

Compression artifacts (such as the MP3 format) are created by a lossy compression scheme where the audio is resampled to lower the bitrate and to remove sounds that are indistinguishable to typical human hearing. The Compressed Music Enhancer feature of this unit enhances your listening experience by regenerating the missing harmonics in a compression artifact. As a result, flattened complexity due to the loss of high-frequency fidelity as well as lack of bass due to the loss of low-frequency bass is compensated, providing the improved performance of the overall sound system.

### Notes

- The Compressed Music Enhancer mode is compatible with the PCM signals (32 kHz, 44.1 kHz and 48 kHz) and the analog 2-channel input sources.
- The Compressed Music Enhancer mode is not effective with any of the sound field programs.
- When the Compressed Music Enhancer mode is turned on while an incompatible input source is being played back, “Not Available” appears in the front panel display.
- When the input source is changed to an incompatible input source while the Compressed Music Enhancer mode is turned on, the Compressed Music Enhancer mode is automatically turned off and the incompatible input source is played back in 2-channel or 6-channel stereo.



The ENHANCER indicator lights up in the front panel display when one of the Compressed Music Enhancer modes is selected.

- 1 Set the component selector switch and then press **ENHANCER** on the remote control repeatedly to select the desired **Compressed Music Enhancer mode**.

The following display is shown in the front panel display and the ENHANCER indicator lights up in the front panel display.

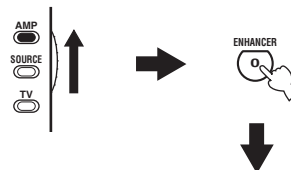

### Lights up



Choices: **2ch Stereo**, 6ch Stereo, Off

- Select “2ch Stereo” to play back compression artifacts in 2-channel stereo.
- Select “6ch Stereo” to play back compression artifacts in 6-channel stereo.
- Select “Off” to turn off the Compressed Music Enhancer mode.

### Note

When you select “Off”, this unit returns to the previously selected sound field program.

- 2 Press **</>** on the remote control to select the desired effect level.

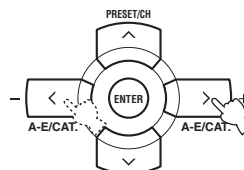

Choices: **HIGH**, LOW

- Select “HIGH” for a high effect level.
- Select “LOW” for a low effect level.

### Note

Set the effect level to “HIGH” or “LOW” according to the characteristics of a source. The high-frequency signals of some sources may be emphasized too much. In this case, set the effect level to “LOW”.



## Selecting the MULTI CH INPUT component

Use this feature to select the component connected to the MULTI CH INPUT jacks (see page 22) as the input source.

Press **MULTI CH INPUT** on the front panel (or **MULTI CH IN** on the remote control) so that “MULTI CH INPUT” appears in the front panel display.

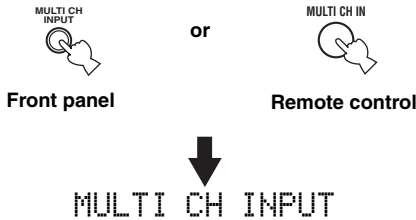

### Note

When “MULTI CH INPUT” is shown in the front panel display, no other source can be played. To select another input source with the INPUT selector on the front panel (or one of the input selector buttons), press MULTI CH INPUT (or MULTI CH IN on the remote control) so that “MULTI CH INPUT” disappears from the front panel display.

## Enjoying multi-channel sources in 2-channel stereo

You can mix down multi-channel sources to 2 channels and enjoy playback in 2-channel stereo.

Set the component selector switch to **AMP** and then press **STEREO** on the remote control repeatedly to select “2ch Stereo”.

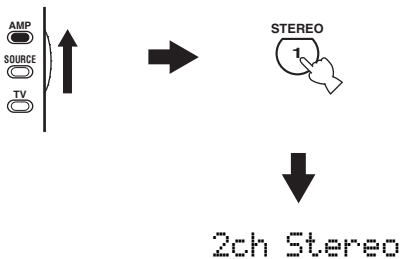

- You can use a subwoofer with this program when “BASS OUT” is set to “SWFR” or “BOTH” (see page 79).
- You can also select “2ch Stereo” by pressing the PROGRAM </> buttons on the front panel.

## Enjoying unprocessed input sources

When this unit is in the “STRAIGHT” mode, 2-channel stereo sources are output from only the front left and right speakers. Multi-channel sources are decoded straight into the appropriate channels without any additional effect processing.

- 1 Set the component selector switch to **AMP** and then press **STRAIGHT** on the remote control to select “STRAIGHT”.

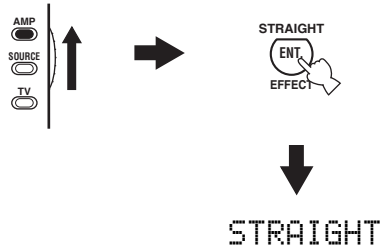

- 2 To deactivate the “STRAIGHT” mode, press **STRAIGHT** on the remote control again so that “STRAIGHT” disappears from the front panel display.

The sound effect is turned back on.



You can also select “STRAIGHT” by pressing **STRAIGHT** (EFFECT) on the front panel.

## Enjoying pure hi-fi stereo sound

The “DIRECT STEREO” mode allows sources to bypass the decoders and DSP processors of this unit so that you can enjoy pure hi-fi sound from 2-channel PCM and analog sources.

Set the component selector switch to AMP and then press DIRECT ST. on the remote control to select “DIRECT STEREO”.

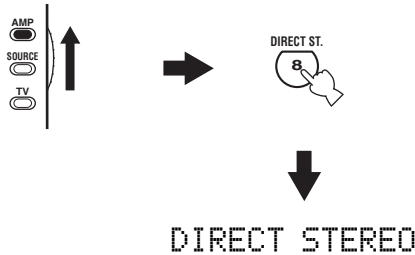

### Notes

- To avoid unexpected noise, do not play CDs encoded in DTS when the “DIRECT STEREO” mode is selected.
- When multi-channel signals (Dolby Digital and DTS) are input, this unit automatically switches to the corresponding analog input. When “DTS” is selected as the input mode (see page 33), no sound will be output.
- No sound will be output from the subwoofer.
- “TONE CONTROL” (see page 31) and “SOUND MENU” (see page 78) settings (except for speaker level settings) are not effective.
- The front panel display automatically dims.



You can also select the “DIRECT STEREO” mode by pressing the PROGRAM </> buttons on the front panel repeatedly.

## Displaying the input source information

You can display the format, sampling frequency, channel, bit rate, and flag data of the current input signal.

- 1 Press one of the input selector buttons to select the desired input source.

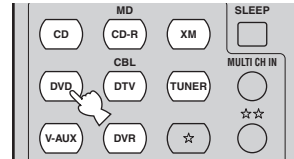

- 2 Set the component selector switch to AMP and then press STRAIGHT on the remote control to select “STRAIGHT”.

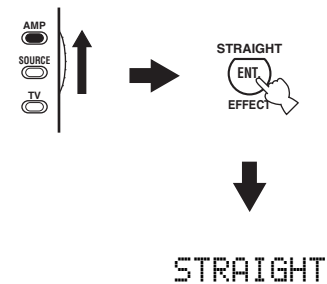

- 3 Press ^ / v to display the information about the input signal.

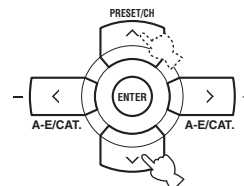

The following information appears in the front panel display for a few seconds.

**Signal format**

Signal format display. When this unit cannot detect a digital signal, it automatically switches to analog input.

Display status: Analog, Digital, Dolby Digital, DTS, PCM, Unknown Digital

**Note**

“Unknown Digital” appears when this unit detects any undecodable digital signals.

**Channel in**

The number of source channels in the input signal (front/surround/LFE). For example, a multi-channel soundtrack with 3 front channels, 2 surround channels and LFE, is displayed as “3/2/LFE”.

**Sampling frequency f<sub>s</sub>**

The number of samples per second taken from a continuous signal to make a discrete signal.

Display status: 32kHz, 44.1kHz, 48kHz, 64kHz, 88.2kHz, 96kHz

**Bit rate rate**

The number of bits passing a given point per second.

**Flag flg**

Flag data encoded in DTS, Dolby Digital, or PCM signals that cue this unit to automatically switch decoders.



When you are displaying information about the input source, this unit is in the “STRAIGHT” mode (see page 37). To turn back the sound effect on, press “STRAIGHT” again.

**Playing video sources in the background**

You can combine a video image from a video source with sound from an audio source. For example, you can enjoy listening to classical music while viewing beautiful scenery from the video source on the video monitor.

**Press the input selector buttons on the remote control to select a video source and then an audio source.**

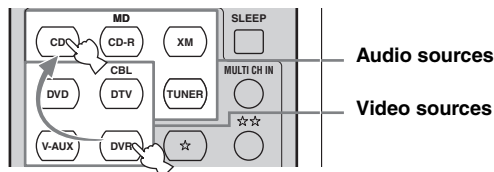

**Note**

If you want to enjoy an audio source input at the MULTI CH INPUT jacks together with a video source, first select the video source and then press MULTI CH INPUT on the front panel (or MULTI CH IN on the remote control) to select “MULTI CH INPUT” as the input source (see page 37).

# ENJOYING SURROUND SOUND

## Enjoying multi-channel sources in surround

If you connected a surround back speaker, use this feature to enjoy 6.1-channel playback for multi-channel sources using the Dolby Pro Logic IIX, Dolby Digital EX or DTS-ES decoders.

- 1 Set the component selector switch to AMP and then press **EXTD SUR.** on the remote control repeatedly to switch between 5.1 and 6.1-channel playback.

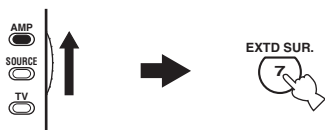

- 2 Press **</>** repeatedly to select a decoder while “PLIIXMusic” (etc.) is displayed.

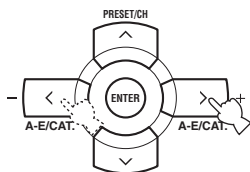

### Auto AUTO

When a signal flag that can be recognized by this unit is input, this unit selects the optimum decoder to play back the signal in 6.1 channels.

If this unit cannot recognize the flag or no flag is present in the input signal, it cannot automatically be played in 6.1 channels.

### Decoders

You can select from the following decoders depending on the format of the source you are playing.

Decoder	Functions
PLIIXMusic	Plays back Dolby Digital or DTS signals in 6.1 channels using the Pro Logic IIX music decoder.
EX/ES	Plays back Dolby Digital or DTS signals in 6.1 channels using the Dolby Digital EX or DTS-ES decoder.
EX	Plays back Dolby Digital or DTS signals in 6.1 channels using the Dolby Digital EX decoder.

### Off OFF

Decoders are not used to create 6.1 channels.

### Notes

- Some 6.1-channel compatible discs do not have a signal flag that can be automatically detected by this unit. When playing these kinds of discs in 6.1 channels, select a decoder manually from “PLIIX Music”, “EX/ES” or “EX”.
- 6.1-channel playback is not possible even if you press EXTD SUR. in the following cases:
  - When “SUR. LR” (see page 78) or “SUR. B” (see page 78) is set to “NONE”.
  - When the source connected to the MULTI CH INPUT jacks is being played.
  - When the source being played does not contain surround left and right channel signals.
  - When a Dolby Digital KARAOKE source is being played.
  - When “2ch Stereo” (see page 37) or “DIRECT STEREO” (see page 38) program is selected.
- When this unit is turned off, this setting will be reset to “AUTO”.
- The Pro Logic IIX decoder is not available when “SUR. B” is set to “NONE” (see page 78).

## Enjoying 2-channel sources in surround

Signals input from 2-channel sources can also be played back on multi-channels.

- 1 Set the component selector switch to AMP and then press STANDARD on the remote control repeatedly to switch between the “SUR. STANDARD” and “SUR. ENHANCED” programs or press MOVIE to select the “MOVIE THEATER” programs.

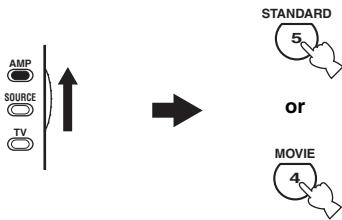

- 2 Press SELECT on the remote control repeatedly to select the desired decoder.



You can select from the following modes depending on the type of source you are playing and your personal preference.



You can also select a decoder by pressing </> on the remote control while the decoder type is displayed in the front panel display.

SUR. STANDARD	Functions
PRO LOGIC	Dolby Pro Logic processing for any sources
PLII Movie	Dolby Pro Logic II processing for movie sources
PLII Music	Dolby Pro Logic II processing for music sources
PLII Game	Dolby Pro Logic II processing for game sources
PLIIx Movie	Dolby Pro Logic Iix processing for movie sources
PLIIx Music	Dolby Pro Logic Iix processing for music sources
PLIIx Game	Dolby Pro Logic Iix processing for game sources
Neo:6 Cinema	DTS processing for movie sources
Neo:6 Music	DTS processing for music sources
Neural Sur.	Neural Surround processing for any sources (U.S.A. and Canada models only)

SUR. ENHANCED or MOVIE THEATER	Functions
PRO LOGIC	Dolby Pro Logic processing for any sources
PLII Movie	Dolby Pro Logic II processing for movie sources
PLIIx Movie	Dolby Pro Logic Iix processing for movie sources
Neo:6 Cinema	DTS processing for movie sources

### Notes

- The Pro Logic Iix decoder is not available when “SUR. B” is set to “NONE” (see page 78).
- The Neural Surround decoder is compatible with the PCM signals (32 kHz, 44.1 kHz, and 48 kHz) and the analog 2-channel input sources.
- The Neural Surround decoder is not effective with any of the sound field programs.
- When Neural Surround-incompatible signals are being input while the Neural Surround decoder is selected, multi-channel sources are decoded straight into the appropriate channels without any additional effect processing and the Neural Surround-incompatible PCM signals are played back in stereo.

## ***Using Virtual CINEMA DSP***

Virtual CINEMA DSP allows you to enjoy the CINEMA DSP programs without surround speakers. It creates virtual speakers to reproduce the natural sound field. If you set “SUR. LR” to “NONE” (see page 78), Virtual CINEMA DSP activates automatically whenever you select a CINEMA DSP sound field program (see page 63).

### **Note**

Virtual CINEMA DSP will not activate even when “SUR. LR” is set to “NONE” (see page 78) in the following cases:

- When the component connected to the MULTI CH INPUT jacks is selected as the input source (see page 37).
- When headphones are connected to the PHONES jack.
- When the “DIRECT STEREO” (see page 38) or “2ch Stereo” mode (see page 37) is selected, or when this unit is in the “STRAIGHT” mode (see page 37).

# RECORDING

Recording adjustments and other operations are performed from the recording components. Refer to the operating instructions for those components.

## Notes

- When this unit is set to the standby mode, you cannot record between other components connected to this unit.
- The setting of the TONE CONTROL (see page 31), VOLUME, the speaker level (see page 79) and the sound field programs (see page 62) do not affect recorded material.
- The source connected to the MULTI CH INPUT jacks of this unit cannot be recorded.
- S-video and composite video signals pass independently through the video circuits of this unit. Therefore, when recording or dubbing video signals input from a video source component that provides only an S-video or a composite video signal, you can record only an S-video or a composite video signal on your VCR.
- Digital signals input at the DIGITAL INPUT jacks are not output at the analog AUDIO OUT (REC) jacks for recording.
- A given input source is not output on the same OUT (REC) channel.
- Check the copyright laws in your country to record from CDs, radio, etc. Recording of copyrighted material may infringe copyright laws.
- The XM Satellite Radio (U.S.A. model only) signals cannot be output at the AUDIO OUT (REC) jacks.



Do a test recording before you start an actual recording.

If you play back a video source that uses scrambled or encoded signals to prevent it from being dubbed, the picture itself may be disturbed due to those signals.

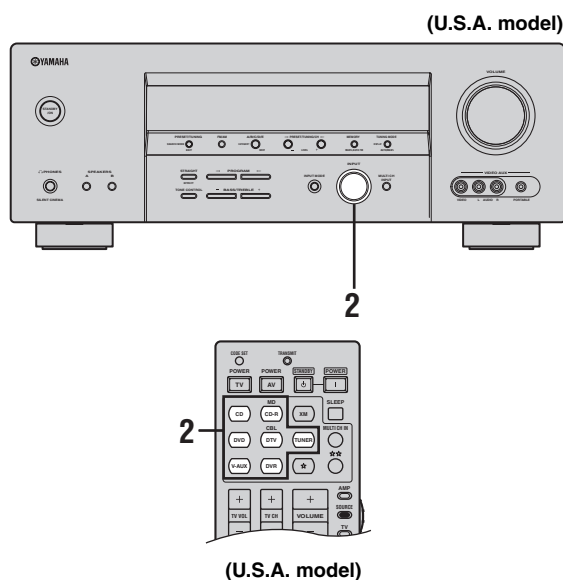

**1** Turn on all the connected components.

**2** Rotate the INPUT selector on the front panel (or press one of the input selector buttons on the remote control) to select the source component you want to record from.

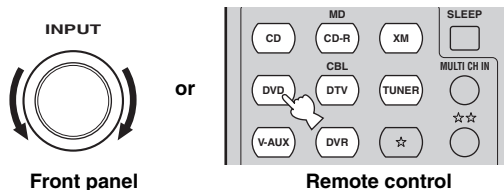

**3** Start playback on the selected source component or select a broadcast station.

**4** Start recording on the recording component.

# FM/AM TUNING

There are 2 tuning methods: automatic and manual. Automatic tuning is effective when station signals are strong and there is no interference. If the signal from the station you want to select is weak, tune into it manually. You can also use the automatic and manual preset tuning features to store up to 40 stations (A1 to E8: 8 preset station numbers in each of the 5 preset station groups). Furthermore, you can recall any preset stations and exchange the assignment of two preset stations with each other.

## Note

Orient the connected FM and AM antenna for the best reception.

## Automatic tuning

Automatic tuning is effective when station signals are strong and there is no interference.

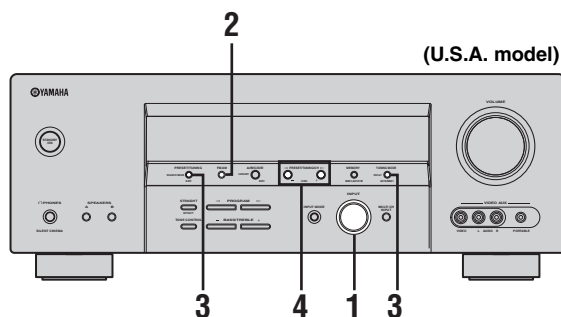

- 1 Rotate the INPUT selector to select "TUNER" as the input source.

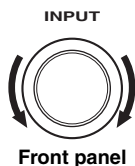

- 2 Press FM/AM to select the reception band. "FM" or "AM" appears in the front panel display.



- 3 Press TUNING MODE (AUTO/MAN'L) so that the AUTO indicator lights up in the front panel display.

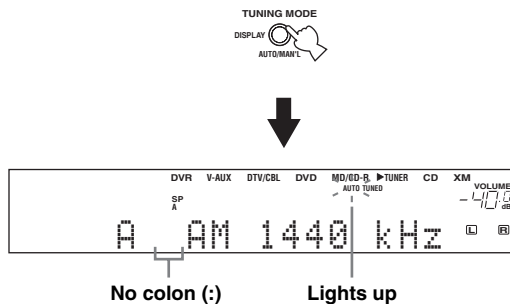

If a colon (:) appears in the front panel display, tuning is not possible. Press PRESET/TUNING to turn the colon (:) off.



- 4 Press PRESET/TUNING/CH < / > once to begin automatic tuning.

When this unit is tuned into a station, the TUNED indicator lights up and the frequency of the received station is shown in the front panel display.

- Press > to tune into a higher frequency.
- Press < to tune into a lower frequency.

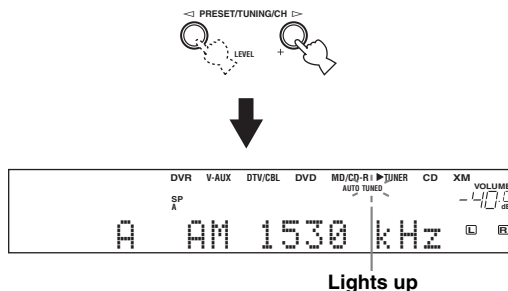



## Manual tuning

If the signal received from the station you want to select is weak, tune into it manually.

### Note

Manually tuning into an FM station automatically switches the tuner to monaural reception to increase the signal quality.

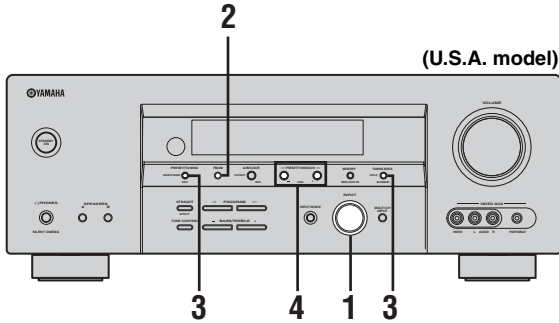

- 1 Rotate the INPUT selector to select "TUNER" as the input source.



- 2 Press FM/AM to select the reception band. "FM" or "AM" appears in the front panel display.



- 3 Press TUNING MODE (AUTO/MAN'L) so that the AUTO indicator disappears from the front panel display.

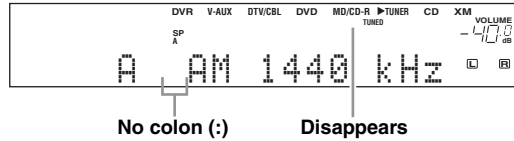

If a colon (:) appears in the front panel display, tuning is not possible. Press PRESET/TUNING (EDIT) to turn the colon (:) off.



- 4 Press PRESET/TUNING/CH </> to tune into the desired station manually. Hold down the button to continue searching.



## Automatic preset tuning

You can use the automatic preset tuning feature to store FM stations with strong signals up to 40 (A1 to E8: 8 preset station numbers in each of the 5 preset station groups) of those stations in order. You can then recall any preset station easily by selecting the preset station number.

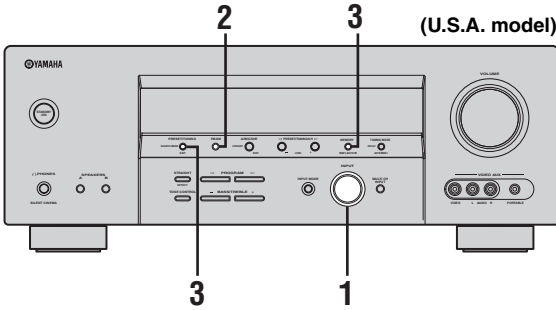

- 1 Rotate the INPUT selector to select "TUNER" as the input source.



- 2 Press FM/AM to select "FM" as the reception band.

"FM" appears in the front panel display.



- 3 Press and hold MEMORY (MAN'L/AUTO FM) for more than 3 seconds.

The preset station number and the MEMORY and AUTO indicators flash. After approximately 5 seconds, automatic presetting starts from the current frequency and proceeds toward the higher frequencies.

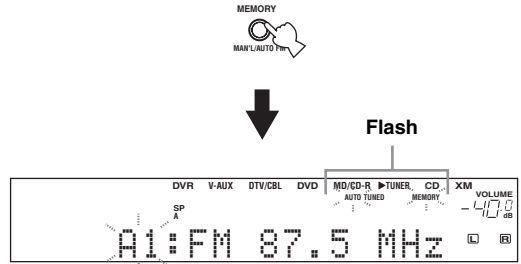

### Flashes

When automatic preset tuning is completed, the front panel display shows the frequency of the last preset station.



You can specify the preset number from which this unit stores FM stations and/or begins tuning toward lower frequencies. For details, see "Automatic preset tuning options" on page 47.

### Notes

- Any stored station data existing under a preset station number is cleared when you store a new station under the same preset station number.
- If the number of received stations does not reach 40 (E8), automatic preset tuning automatically stops after searching for all the available stations.
- Only FM stations with sufficient signal strength are stored automatically by automatic preset tuning. If the station you want to store is weak in signal strength, tune into it manually and store it as described in "Manual preset tuning".

### Automatic preset tuning options

You can specify the preset number from which this unit stores FM stations and/or begins tuning toward lower frequencies.

**Note**

First carry out steps 1 through 3 in “Automatic preset tuning” on page 46.

- Press **A/B/C/D/E** and then **PRESET/TUNING/CH** ◀/▶ to select the preset station number under which the first station will be stored.

Automatic preset tuning stops when stations have all been stored up to E8.



- Press **PRESET/TUNING** so that the colon (:)  
disappears from the front panel display and then press **PRESET/TUNING/CH** ◀ to begin tuning toward lower frequencies.



## Manual preset tuning

You can also store up to 40 stations (A1 to E8: 8 preset station numbers in each of the 5 preset station groups) manually.

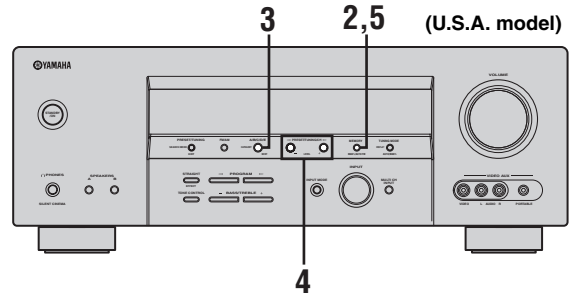

### 1 Tune into a station automatically or manually.

See pages 44 and 45 for tuning instructions.

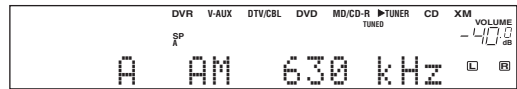

When this unit is tuned into a station, the front panel display shows the frequency of the station received.

### 2 Press MEMORY (MAN'L/AUTO FM).

The MEMORY indicator flashes in the front panel display for approximately 5 seconds.



### 3 Press A/B/C/D/E repeatedly to select a preset station group (A to E) while the MEMORY indicator is flashing.

The selected preset station group letter appears.

Check that the colon (:) appears in the front panel display.

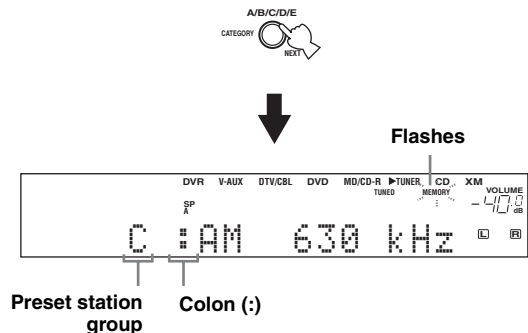

**4 Press PRESET/TUNING/CH </> to select a preset station number (1 to 8) while the MEMORY indicator is flashing.**

- Press > to select a higher preset station number.
- Press < to select a lower preset station number.

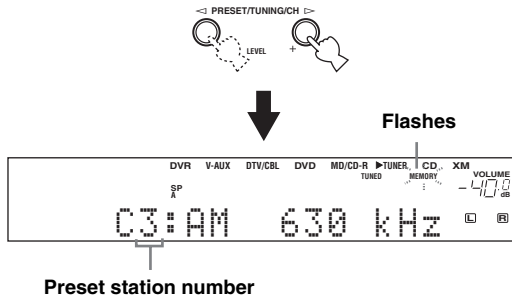

**5 Press MEMORY (MAN'L/AUTO FM) while the MEMORY indicator is flashing.**

The station band and frequency appear in the front panel display with the preset station group and number you have selected. The MEMORY indicator disappears from the front panel display.

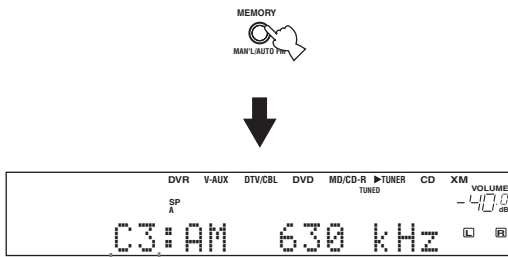

The displayed station has been stored as C3.

**6 Repeat steps 1 through 5 to store other stations.**

**Notes**

- Any stored station data existing under a preset station number is cleared when you store a new station under the same preset station number.
- The reception mode (stereo or monaural) is stored along with the station frequency.

**Selecting preset stations**

You can tune into any desired station simply by selecting the preset station group and number under which it was stored.

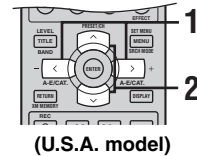
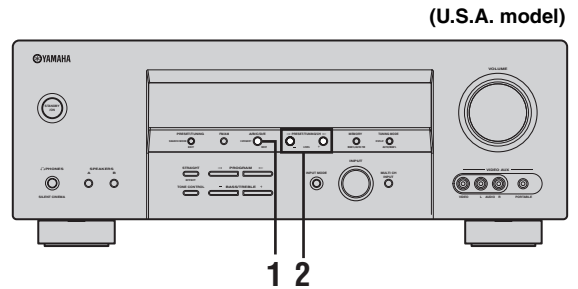

When performing this operation with the remote control, set the component selector switch to SOURCE and then press TUNER to select "TUNER" as the input source.

**1 Press A/B/C/D/E on the front panel (or A-E/CAT. </> on the remote control) to select the desired preset station group (A to E).**

The preset station group letter appears in the front panel display and changes each time you press the button.

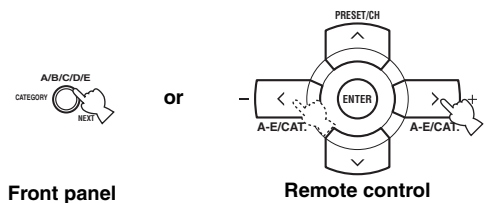

- 2** Press PRESET/TUNING/CH ◀/▶ on the front panel (or PRESET/CH ^/∨ on the remote control) to select the desired preset station number (1 to 8).

The preset station group and number appear in the front panel display along with the station band and frequency.

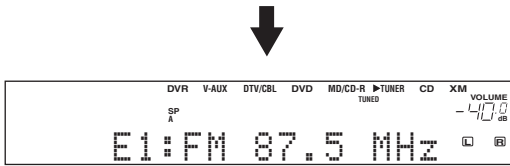
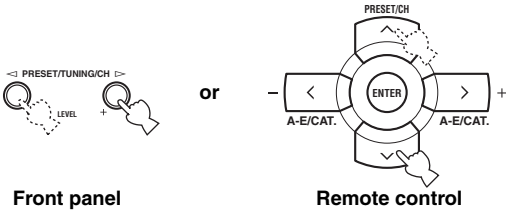

 You can select the desired preset station number (1 to 8) directly by pressing the numeric buttons on the remote control.

## Exchanging preset stations

You can exchange the assignments of two preset stations with each other. The example below describes the procedure to exchange preset station “E1” with “A5”.

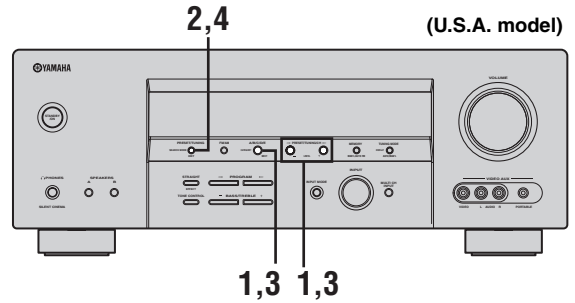

- 1** Select preset station “E1” using A/B/C/D/E and PRESET/TUNING/CH ◀/▶.

See “Selecting preset stations” on page 48.

- 2** Press and hold EDIT for more than 3 seconds.

“E1” and the MEMORY indicator flash in the front panel display.

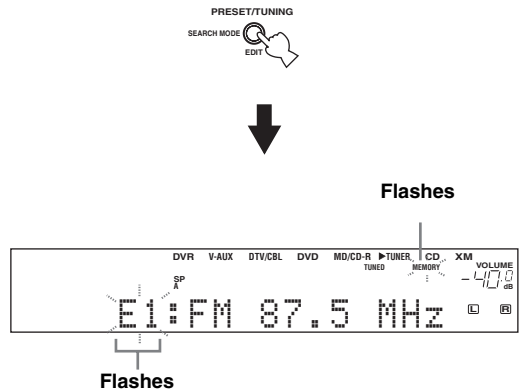

**3 Select preset station “A5” using A/B/C/D/E and PRESET/TUNING/CH </>.**

“A5” and the MEMORY indicator flash in the front panel display.

See “Selecting preset stations” on page 48.

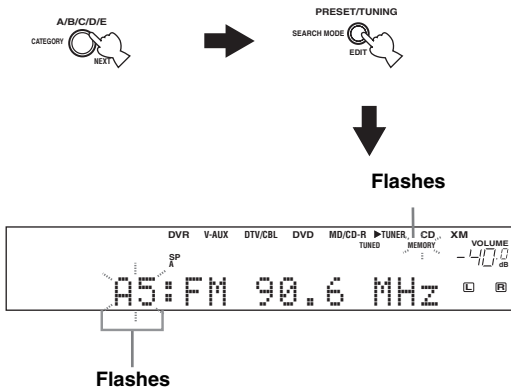

**4 Press EDIT again.**

“EDIT E1–A5” appears in the front panel display and the assignments of the two preset stations are exchanged.

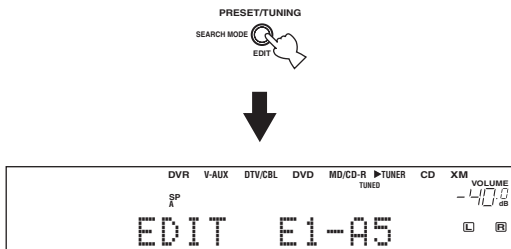

# XM<sup>®</sup> SATELLITE RADIO TUNING

XM Satellite Radio is the satellite radio service with millions of listeners across the United States, broadcasting live daily. The XM Satellite Radio channel lineup includes more than 150 digital channels of choice from coast to coast: 67 commercial-free music channels, featuring hip hop to opera, classical to country, bluegrass to blues; 33 channels of premier sports, talk, comedy, children's and entertainment programming; and more than 20 channels of the traffic and weather information for major metropolitan areas nationwide.

Because XM Satellite Radio is a subscription service, you will need to set up an account and activate service with XM using your XM Satellite Radio ID number. To check your ID number, follow "Activating XM Satellite Radio" on page 53. For further information on XM Satellite Radio services, visit the XM Satellite Radio website at "http://www.xmradio.com/".

This unit is equipped with the Neural Surround decoder (U.S.A. and Canada models only) that plays back the surround sound content of the XM Satellite Radio broadcasts in multi-channels, resulting in a full surround sound experience.

## Notes

- The XM Satellite Radio service is only available in the 48 contiguous United States (not available in Alaska and Hawaii).
- XM Connect-and-Play digital antenna accessory and monthly subscription are sold separately. For details, visit the XM Satellite Radio website at "http://www.xmradio.com/".
- For information on obtaining the XM Connect-and-Play digital antenna accessory, visit the XM Satellite Radio website at "http://www.xmradio.com/" or consult your local retailer that sells XM Ready products.
- To ensure the optimal reception of the XM Satellite Radio signals, the XM Connect-and-Play digital antenna accessory must be placed at or near a southerly facing window with no obstacles in the path to the sky. You can mount it indoors or outdoors.

## Information from XM Satellite Radio Inc.

Hardware and required basic monthly subscription sold separately. Premium Channel available at additional monthly cost. Installation costs and other fees and taxes, including a one-time activation fee may apply. Subscription fee is consumer only. All fees and programming subject to change. Channels with frequent explicit language are indicated with an "XL". Channel blocking is available for XM radio receivers by calling "1-800-XM-RADIO (1-800-967-2346)". Subscriptions subject to Customer Agreement available at xmradio.com. Only available in the 48 continuous United States. © 2005 XM Satellite Radio Inc. All rights reserved. All other trademarks are the property of their respective owners.

## Connecting the XM Connect-and-Play digital antenna accessory

Connect the XM Connect-and-Play digital antenna accessory (sold separately) to the XM jack on the rear panel of this unit. For details, see the operating instructions provided with the XM Connect-and-Play digital antenna accessory.

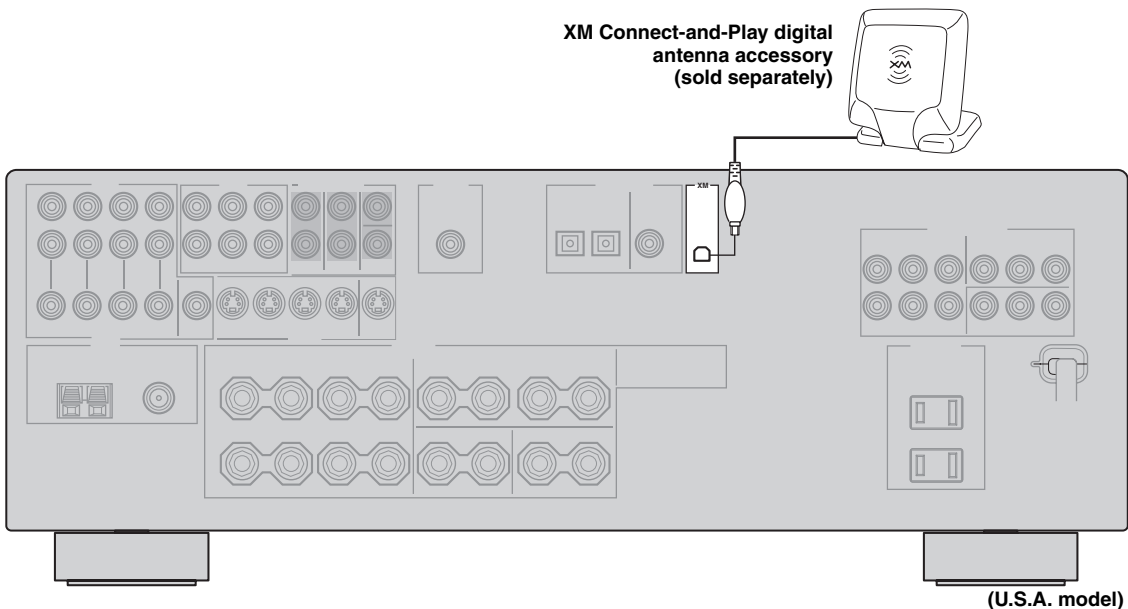

## XM Satellite Radio controls and functions

### Note

The following controls are available only when “XM” is selected as the input source. Rotate the INPUT selector on the front panel (or set the component selector switch to SOURCE and then press XM on the remote control) to select “XM” as the input source.

### ■ Front panel functions

(U.S.A. model)

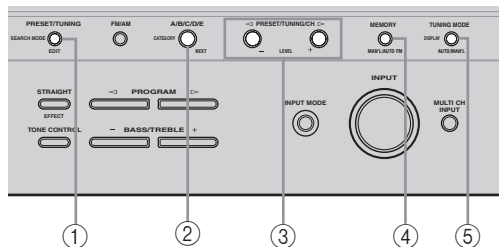

#### ① SEARCH MODE

Changes the search mode between the All Channel Search, Category Search, and Preset Search modes (see page 55).

#### ② CATEGORY

##### (All Channel Search mode)

Changes the channel category while staying in the All Channel Search mode.

##### (Category Search mode)

Changes the channel category.

##### (Preset Search mode)

Changes the preset channel group (A to E).

#### ③ PRESET/TUNING/CH </>/▷

##### (All Channel Search mode)

Searches for a channel within all channels. Press and hold for quick search.

##### (Category Search mode)

Searches for a channel within the selected category. Press and hold for quick search.

##### (Preset Search mode)

Changes the preset channel number (1 to 8).

#### ④ MEMORY (MAN'L/AUTO FM)

Stores a preset channel in the memory (see page 59).

#### ⑤ DISPLAY

Displays the XM Satellite Radio information such as channel number, channel name, category, artist name, or song title displayed in the front panel display (see page 60).

### ■ Remote control functions

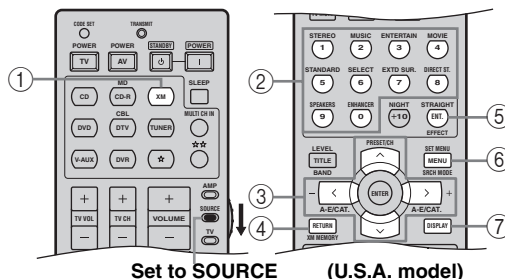

Set to SOURCE (U.S.A. model)

#### ① XM

Selects “XM” as the input source.

#### ② Numeric buttons

##### (All Channel Search or Category Search mode)

Use 1 to 9 and 0 to enter a channel number directly.

##### (Preset Search mode)

Use 1 to 8 to enter a preset channel number directly.

#### ③ Cursor buttons ^ / v / < / >

##### (All Channel Search mode)

Press A-E/CAT. </> to change the channel category.

Press PRESET/CH ^ / v to search for a channel within all channels. Press and hold for quick search.

##### (Category Search mode)

Press A-E/CAT. </> to change the channel category.

Press PRESET/CH ^ / v to search for a channel within the selected category. Press and hold for quick search.

##### (Preset Search mode)

Press A-E/CAT. </> to change the preset channel group (A to E).

Press PRESET/CH ^ / v to change the preset channel number (1 to 8).

#### ④ XM MEMORY

Stores a preset channel in the memory (see page 59).

#### ⑤ ENT.

Confirms an entered channel number in the Direct Number Access mode (see page 58).

#### ⑥ SRCH MODE

Changes the search mode between the All Channel Search, Category Search, and Preset Search modes (see page 55).

#### ⑦ DISPLAY

Displays the XM Satellite Radio information such as channel number, channel name, category, artist name, or song title displayed in the front panel display (see page 60).



## Activating XM Satellite Radio

To sign up for an account with the XM Satellite Radio service, an XM Satellite Radio ID number is required. Follow the procedure below to check your ID number, and then visit the website at “http://activate.xmradio.com” or call “1-800-XM-RADIO (1-800-967-2346)” with a major credit card handy for signing up.

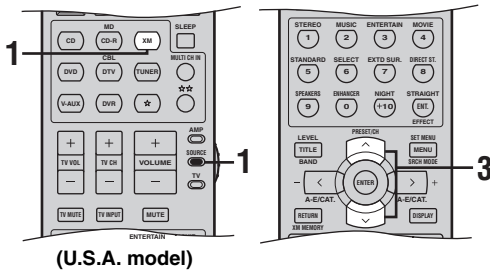
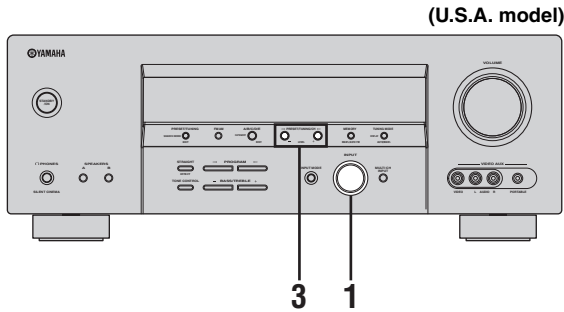

- 1 **Rotate the INPUT selector on the front panel (or set the component selector switch to SOURCE and then press XM on the remote control) to select “XM” as the input source.**  
The cursor on the left of the XM indicator lights up in the front panel display.

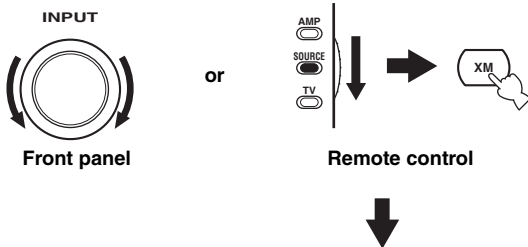

Lights up



- 2 **Check the XM Satellite Radio reception level and adjust the orientation of the XM Connect-and-Play digital antenna accessory for a better percentage of the reception level.**



You can display the XM Satellite Radio reception level by using the “XM ANT.” parameter in “OPTION MENU” (see page 83).

### Notes

- If “CHECK ANTENNA” appears in the front panel display, the XM Connect-and-Play digital antenna accessory may not be connected to the XM jack on the rear panel of this unit properly. See “Connecting the XM Connect-and-Play digital antenna accessory” on page 51 and check the connection.
- The “XM ANT.” parameter in “OPTION MENU” (see page 83) cannot be adjusted by using the remote control. Instead, you need to adjust the orientation of the XM Connect-and-Play digital antenna accessory connected to the XM jack of this unit for a better percentage of the reception level.

- 3 **Press PRESET/TUNING/CH </> on the front panel (or PRESET/CH ^ / v on the remote control) to select channel “0”.**

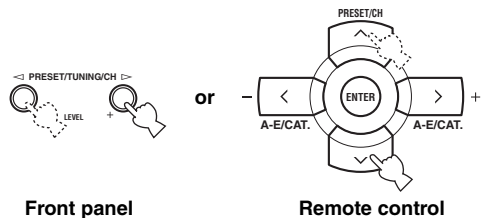

### Note

You cannot select channel “0” if the All Channel Search mode (see page 55) is not selected.

- 4 **Check the XM Satellite Radio ID number displayed in the front panel display and write it down.**

ID: \_\_\_\_\_

## Basic XM Satellite Radio operations

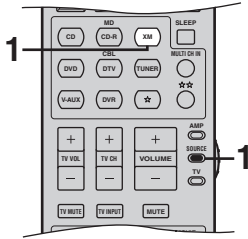

(U.S.A. model)

## 2 Search for a channel by using one of the XM Satellite Radio search modes.

See “Selecting the XM Satellite Radio search mode” on page 55 for details.



- You can use the Neural Surround decoder to enjoy the surround sound content of the XM Satellite Radio broadcasts in multi-channels (see page 41).
- You can set the XM Satellite Radio preset channels (see page 59).
- You can display the XM Satellite Radio information in the front panel display (see page 60).

## 1 Set the component selector switch to SOURCE and then press XM on the remote control to select “XM” as the input source.

The cursor on the left of the XM indicator lights up in the front panel display and the XM Satellite Radio information (such as channel number, channel name, category, artist name, or song title) for the currently selected channel appears in the front panel display.

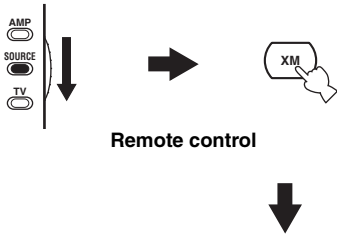

Remote control



Lights up

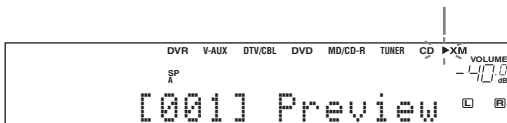

When you select “XM” as the input source, this unit automatically recalls the previously selected channel.

### Note

The XM Satellite Radio signals cannot be output at the AUDIO OUT (REC) jacks.

## Selecting the XM Satellite Radio search mode

You can search for the desired channel using one of the three search modes (All Channel Search, Category Search, and Preset Search modes). You can also enter the channel number directly to select the desired channel by using the Direct Number Access mode (see page 58).

### All Channel Search mode

(U.S.A. model)

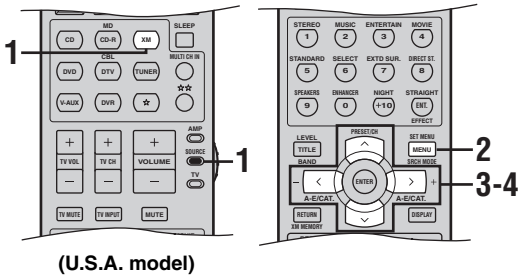
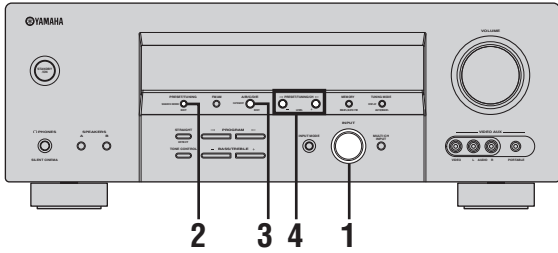

- 1 Rotate the INPUT selector on the front panel (or set the component selector switch to SOURCE and then press XM on the remote control) to select “XM” as the input source.



or

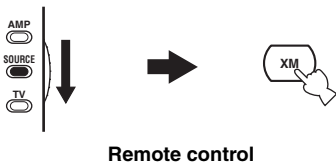

- 2 Press SEARCH MODE on the front panel (or SRCH MODE on the remote control) repeatedly to select “ALL CH SEARCH”.

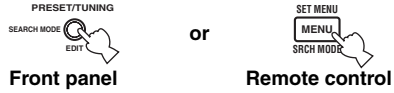

- 3 Press CATEGORY on the front panel (or A-E/CAT. </> on the remote control) repeatedly to change the channel category.

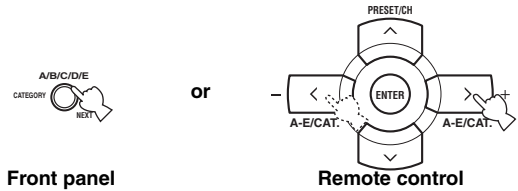

- 4 Press PRESET/TUNING/CH </> on the front panel (or PRESET/CH ^ / v on the remote control) repeatedly to search for a channel within all channels.

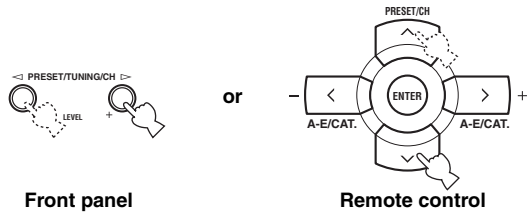

You can search for a channel quickly by pressing and holding PRESET/TUNING/CH </> on the front panel (or PRESET/CH ^ / v on the remote control).

■ Category Search mode

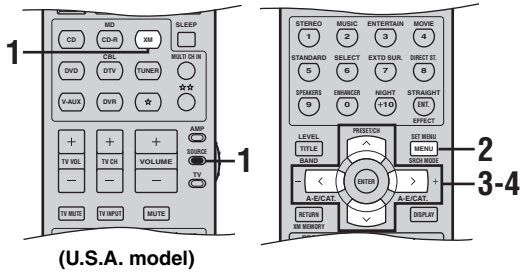
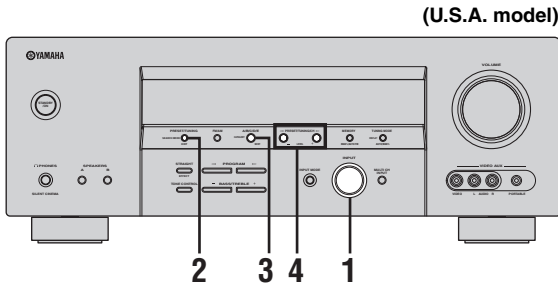

- 1** Rotate the INPUT selector on the front panel (or set the component selector switch to SOURCE and then press XM on the remote control) to select “XM” as the input source.



or

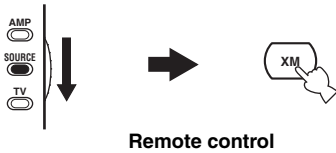

- 2** Press SEARCH MODE on the front panel (or SRCH MODE on the remote control) repeatedly to select “CAT SEARCH”.



or

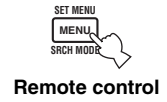

- 3** Press CATEGORY on the front panel (or A-E/CAT. </> on the remote control) repeatedly to change the channel category.



or

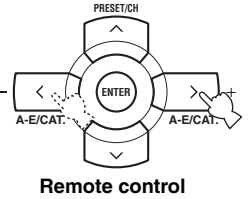

- 4** Press PRESET/TUNING/CH </> on the front panel (or PRESET/CH ^ / v on the remote control) repeatedly to search for a channel within the selected channel category.

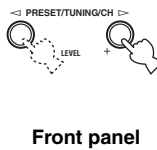

or

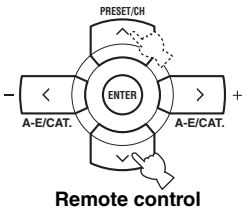

You can search for a channel quickly by pressing and holding PRESET/TUNING/CH </> on the front panel (or PRESET/CH ^ / v on the remote control).

## ■ Preset Search mode

Prior to selecting a preset channel in the Preset Search mode, you must preset XM Satellite Radio channels. For details, see “Setting the XM Satellite Radio preset channels” on page 59.



All preset channels (A1 to E8) recalls “001 Preview” by the initial factory setting.

(U.S.A. model)

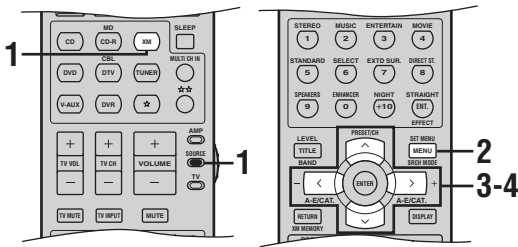
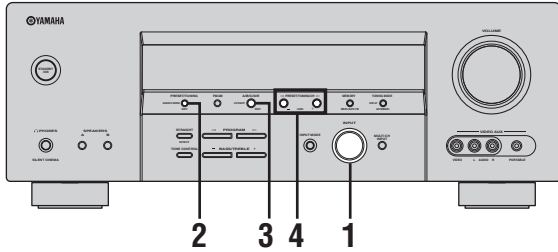

(U.S.A. model)

- 1 Rotate the INPUT selector on the front panel (or set the component selector switch to SOURCE and then press XM on the remote control) to select “XM” as the input source.

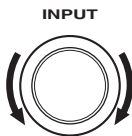

Front panel

or

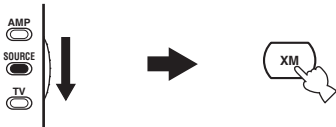

Remote control

- 2 Press SEARCH MODE on the front panel (or SRCH MODE on the remote control) repeatedly to select “PRESET SEARCH”.

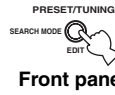

or



Remote control

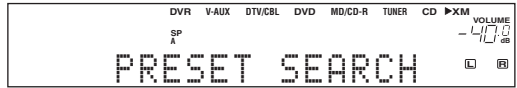

- 3 Press CATEGORY on the front panel (or A-E/CAT. </> on the remote control) repeatedly to change the preset channel group (A to E).



or

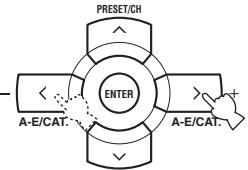

Front panel

Remote control

- 4 Press PRESET/TUNING/CH </> on the front panel (or PRESET/CH ^ / v on the remote control) repeatedly to change the preset channel number (1 to 8).

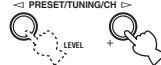

or

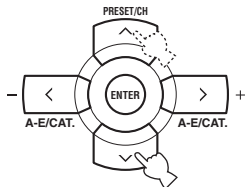

Front panel

Remote control



You can also select the preset channel number directly by pressing the numeric buttons (1 to 8) on the remote control.

■ Direct Number Access mode

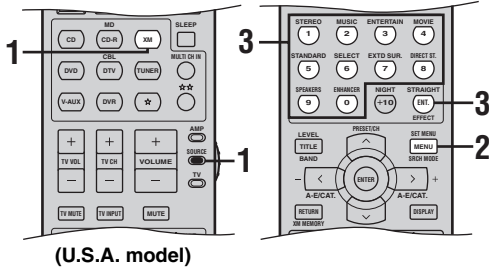

**1** Set the component selector switch to **SOURCE** and then press **XM** on the remote control to select “XM” as the input source.



**2** Press **SRCH MODE** on the remote control repeatedly to select “ALL CH SEARCH” or “CAT SEARCH”.

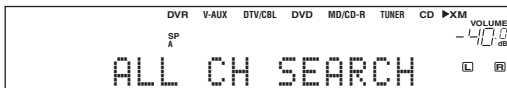

or



**3** Press the numeric buttons on the remote control to enter the desired three-digit channel number.

For example, to enter the number 123, press the numeric buttons as shown below.



The display changes as follows.

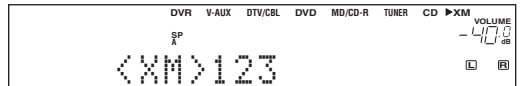
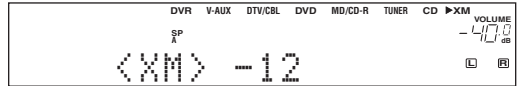
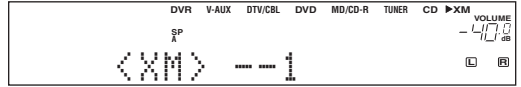

Press the numeric buttons and **ENT.** on the remote control to enter the desired one-digit or two-digit channel number.

For example, to enter the number 12, press the numeric buttons as shown below.



- Instead of pressing **ENT.** to tune into the channel immediately, you can wait a few seconds until this unit confirms the entered channel number.
- If no button is pressed within a few seconds after you enter a one-digit or two-digit number, this unit automatically confirms the entered channel number.
- Pressing a button other than the numeric buttons or **ENT.** cancels the Direct Number Access mode procedure.

## Setting the XM Satellite Radio preset channels

You can use this feature to store up to 40 XM Satellite Radio channels (A1 to E8: 8 preset channel numbers in each of the 5 preset channel groups). You can then recall any preset channel easily by selecting the preset channel group and number as described in “Preset Search mode” on page 57.

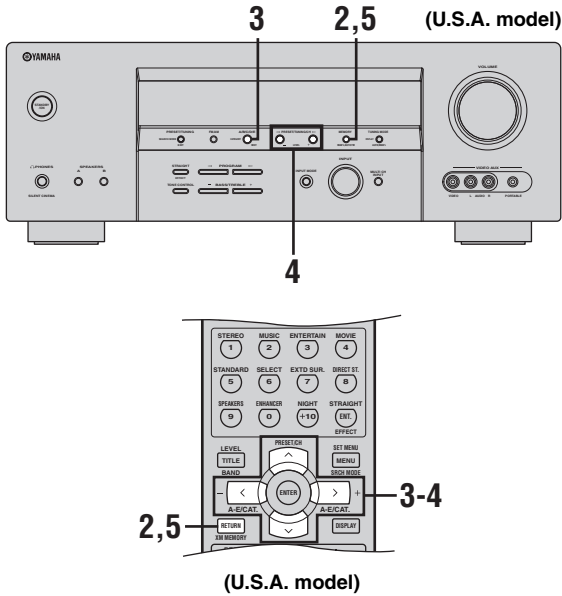

### 1 Search for a channel you want to set as a preset channel by using one of the XM Satellite Radio search modes.

See “Selecting the XM Satellite Radio search mode” on page 55 for details.



Currently selected channel number

### 2 Press MEMORY on the front panel (or XM MEMORY on the remote control).

The MEMORY indicator flashes in the front panel display for approximately 5 seconds.

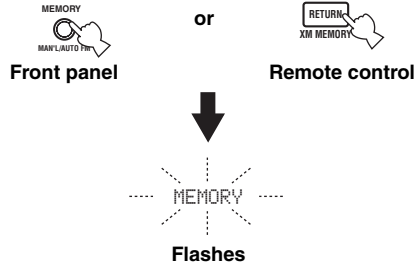

#### Note

You must proceed to and carry out steps 3 through 5 while the MEMORY indicator is flashing in the front panel display.

### 3 Press CATEGORY on the front panel (or A-E/CAT. </> on the remote control) repeatedly to select a preset channel group (A to E) while the MEMORY indicator is flashing.

The preset channel group letter appears in the front panel display.

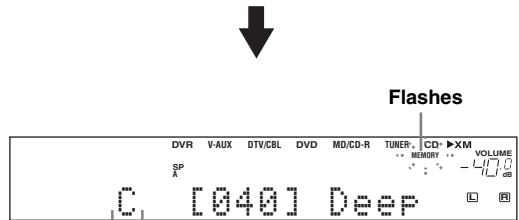
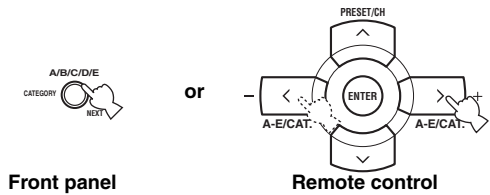

Currently selected preset channel group

- 4 Press PRESET/TUNING/CH ◀/▶ on the front panel (or PRESET/CH ^/▼ on the remote control) repeatedly to select a preset channel number (1 to 8) while the MEMORY indicator is flashing.**

The preset channel number appears in the front panel display.

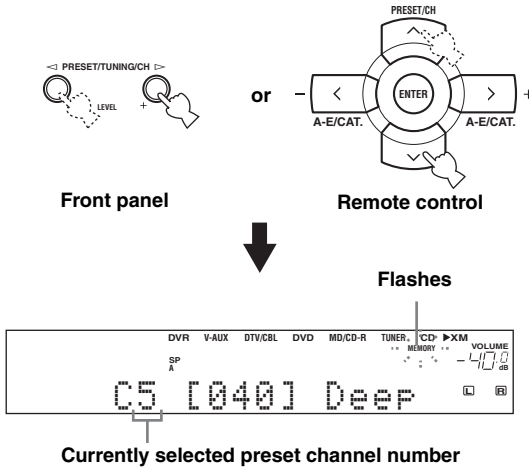

- 5 Press MEMORY on the front panel (or XM MEMORY on the remote control) to set the selected XM Satellite Radio channel as a preset channel while the MEMORY indicator is flashing.**

A colon (:) appears next to the preset channel number for confirmation, and the MEMORY indicator turns off in the front panel display.

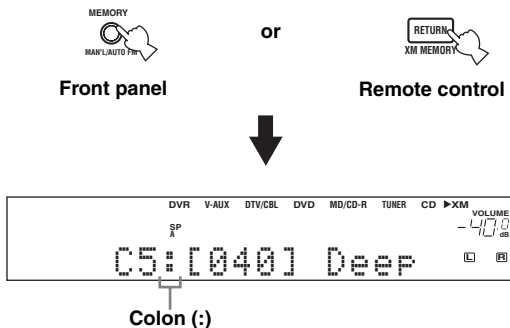

**Note**

Once you set a new preset channel, the one previously stored in the same preset channel group and number is cleared.

**Displaying the XM Satellite Radio information**

You can display the XM Satellite Radio information (such as channel number, channel name, category, artist name, or song title) for the currently selected channel in the front panel display.

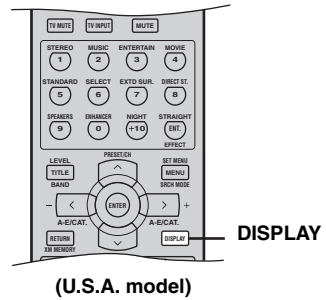
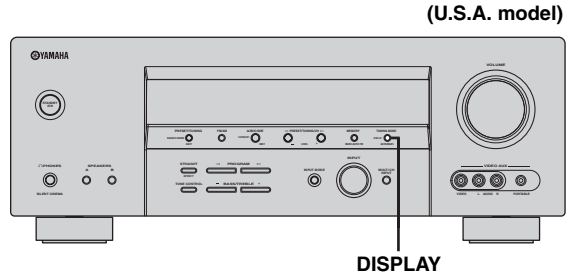

**Note**

If a status message or an error message appears in the front panel display, see the “XM Satellite Radio (U.S.A. model only)” section in “TROUBLESHOOTING” on page 95 for appropriate remedies.

**■ Displaying the XM Satellite Radio information in the front panel display**

Press DISPLAY on the front panel or on the remote control repeatedly to toggle between the following XM information display modes.

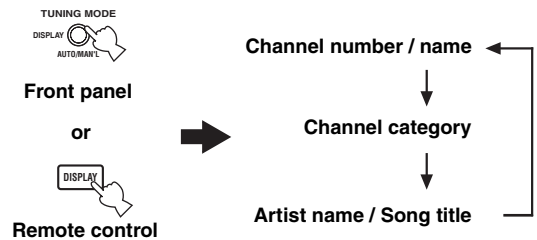



When the channel number / name is displayed:

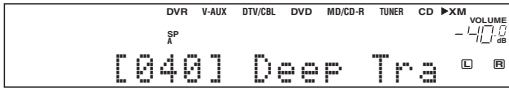

When the channel category is displayed:



When the artist name / song title is displayed:

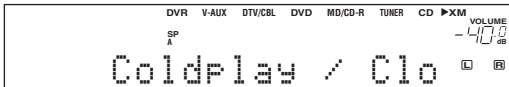

- The front panel display can indicate up to 14 alphanumeric characters at once. You can set whether to display the XM Satellite Radio information in the front panel display in a continuous manner or by 14 alphanumeric characters at once by using the “SCROLL” parameter in “OPTION MENU” (see page 83).
- If the XM Satellite Radio information contains a character that cannot be recognized by this unit, the character will be replaced with a space.

**Note**

If you press DISPLAY while the XM Satellite Radio information display is scrolling from right to left in the front panel display, the XM Satellite Radio information display mode toggles as described above.

# SOUND FIELD PROGRAMS

What really creates the rich, full tones of a live instrument are the multiple reflections from the walls of the room. In addition to making the sound live, these reflections enable us to tell where the player is situated as well as the size and shape of the room in which we are sitting.

## ■ Elements of a sound field

There are two distinct types of sound reflections that combine to make up the sound field in addition to the direct sound coming straight to our ears from the player's instrument.

### Early reflections

Reflected sounds reach our ears extremely rapidly (50 ms to 100 ms after the direct sound), after reflecting from one surface only (for example, from a wall or the ceiling). Early reflections actually add clarity to the direct sound.

### Reverberations

These are caused by reflections from more than one surface (for example, from the walls, and the ceiling) so numerous that they merge together to form a continuous sonic afterglow. They are non-directional and lessen the clarity of the direct sound.

Direct sound, early reflections and subsequent reverberations taken together help us to determine the subjective size and shape of the room, and it is this information that the digital sound field processor reproduces in order to create sound fields.

If you could create the appropriate early reflections and subsequent reverberations in your listening room, you would be able to create your own listening environment. The acoustics in your room could be changed to those of a concert hall, a dance floor, or a room with virtually any size at all. This ability to create sound fields at will is exactly what YAMAHA has done with the digital sound field processor.

## Selecting sound field programs

### Notes

- Choose a sound field program based on your listening preference, not merely on the name of the program.
- When you select an input source, this unit automatically selects the last sound field program used with the corresponding input source.
- Sound field programs cannot be selected when the component connected to the MULTI CH INPUT jacks is selected as the input source (see page 37).
- Sampling frequencies higher than 48 kHz (except for DTS 96/24 signals) are sampled down to 48 kHz and then sound field programs are applied.

## ■ Front panel operations

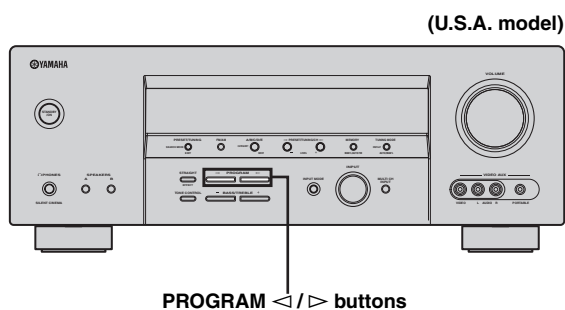

**Press the PROGRAM </> buttons on the front panel repeatedly.**

The name of the selected sound field program appears in the front panel display.

## ■ Remote control operations

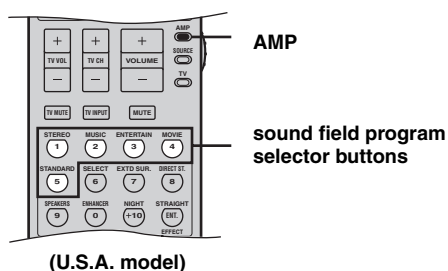

**Set the component selector switch to AMP and then press one of the sound field program selector buttons on the remote control repeatedly.**

The name of the selected sound field program appears in the front panel display.

## Sound field program descriptions

This unit is equipped with a variety of precise digital decoders that allow you to enjoy multi-channel playback from almost any stereo or multi-channel sound source. This unit is also equipped with a YAMAHA digital sound field processing (DSP) chip containing several sound field programs which you can use to enhance your playback experience.



The YAMAHA CINEMA DSP modes are compatible with all Dolby Digital, DTS, and Dolby Surround sources. Set “INPUT MODE” to “AUTO” (see page 33) to enable this unit to automatically switch to the appropriate digital decoder according to the input signal.

### Notes

- The DSP sound field programs of this unit are recreations of real-world acoustic environments made from precise measurements taken in the actual concert hall, music venue, movie theater, etc. Thus, you may notice variations in the strength of the reflections coming from the front, back, left and right.
- Choose a sound field program based on your listening preference, not merely on the name of the program itself.

### ■ For movie/video sources

You can select from the following sound fields when playing movie or video sources. The sound fields marked “MULTI” can be used with multi-channel sources, like DVD, digital TV, etc. Those marked “2-CH” can be used with 2-channel stereo sources like TV programs, video tapes, etc.



Press the PROGRAM </> buttons on the front panel (or set the component selector switch to AMP and then press one of the sound field program selector buttons on the remote control) to select the desired sound field program (see page 62).

Remote control button	Sound Field Program	Features	Sources
1	STEREO 2ch Stereo	Downmixes multi-channel sources to 2 channels or plays back 2-channel sources as they are.	
2	MUSIC Pop/Rock	CINEMA DSP processing. Creates an enthusiastic atmosphere where you can feel as if you are in an actual jazz or rock concert.	
3	ENTERTAINMENT TV Sports	CINEMA DSP processing. Reproduces the sound environment of a large concert hall using the surround sound field to enhance your experience of watching various TV programs such as news, variety shows, music programs or sports programs.	MULTI 2-CH
	ENTERTAINMENT Mono Movie	CINEMA DSP processing. Reproduces monaural video sources (such as old movies) at the optimum reverberation level to create sound depth using only the presence sound field.	
	ENTERTAINMENT Game	CINEMA DSP processing. Adds a deep and spatial feeling to video game sounds.	

Remote control button	Sound Field Program	Features	Sources
4	MOVIE THEATER Spectacle	CINEMA DSP processing. This program reproduces the extremely wide sound field of a 70-mm movie theater in detail, making both the video and the sound field incredibly real. This is ideal for any kind of video source encoded in Dolby Surround, Dolby Digital or DTS, especially large-scale movie productions.	<b>MULTI 2-CH</b>
	MOVIE THEATER Sci-Fi	CINEMA DSP processing. This program reproduces dialog and sound effects in the latest sound form for science fiction films, thus creating a broad and expansive cinematic space amid silence. You can enjoy science fiction films encoded in Dolby Surround, Dolby Digital or DTS in a virtual-space sound field employing the most advanced techniques.	
	MOVIE THEATER Adventure	CINEMA DSP processing. This program reproduces the sound design of the newest 70-mm and multi-channel soundtrack films similar to the sound field of the newest movie theaters, so the reverberations of the sound field itself are restrained as much as possible.	
	MOVIE THEATER General	CINEMA DSP processing. This program reproduces sounds from 70-mm and multi-channel soundtrack films characterized by soft and extensive sound field.	
5	SUR. STANDARD	Standard processing for the selected decoder.	
	SUR. ENHANCED	Enhanced processing for the selected decoder.	

■ **For music sources**

You can select from the following sound fields when playing music sources, like CD, FM/AM broadcasting, tapes, etc.



Press the PROGRAM </> buttons on the front panel (or set the component selector switch to AMP and then press one of the sound field program selector buttons on the remote control) to select the desired sound field program (see page 62).

Remote control button	Sound Field Program	Features	Sources
1	STEREO 2ch Stereo	Plays back 2-channel sources.	<b>2-CH</b>
	STEREO 6ch Stereo	Plays back 2-channel sources from all speakers in 6.1 channels, providing a larger sound field ideal for background music at parties, etc.	
2	MUSIC Hall in Vienna	HiFi DSP processing. The program reproduces a classic shoe-box type concert hall with approximately 1700 seats. Pillars and ornate carvings create extremely complex reflections which produce a very full, rich sound.	<b>MULTI 2-CH</b>
	MUSIC The Bttm Line	HiFi DSP processing. This program reproduces the stage front in "The Bottom Line", a famous New York jazz club where 300 people can be seated.	
	MUSIC The Roxy Thtr	HiFi DSP processing. This program reproduces the dynamic rock music environment of "The Roxy Theatre", one of the hottest rock clubs in L.A. The listener's imaginary seat is at the center-left of the hall.	
3	ENTERTAINMENT Disco	HiFi DSP processing. This program reproduces the acoustic environment of a lively disco in the heart of a big city to create a highly concentrated and energetic sound.	
5	SUR. STANDARD	Standard processing for the selected decoder.	
	SUR. ENHANCED	Enhanced processing for the selected decoder.	

## Changing sound field parameter settings

You can enjoy good quality sound with the initial factory settings. Although you do not have to change the initial factory settings, you can change some of the parameters to better suit the input source or your listening room.

### Notes

- Use the "PARAM. INI" feature in "OPTION MENU" to initialize the parameters of each sound field program within a sound field program group (see page 83).
- You cannot change the sound field parameter values when "MEMORY GUARD" in "OPTION MENU" is set to "ON" (see page 83). If you want to change the sound field parameter values, set "MEMORY GUARD" to "OFF".



- For details about the function and control range of each sound field parameter, see page 66.
- Repeat steps 2 and 3 as necessary to change other sound field program parameter settings.
- If you press and hold </> to change the sound field parameter value, the initial factory settings are shown momentarily in the front panel display.

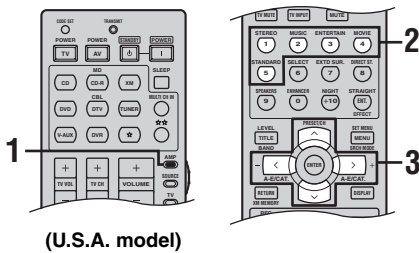

(U.S.A. model)

- 2 Press one of the sound field program selector buttons repeatedly to select the desired sound field program you want to adjust.

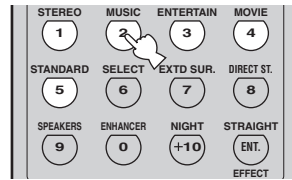

- 3 Press ^ / v to select the desired sound field parameter and then </> to change the selected sound field parameter value.

- Press > to increase the value.
- Press < to decrease the value.

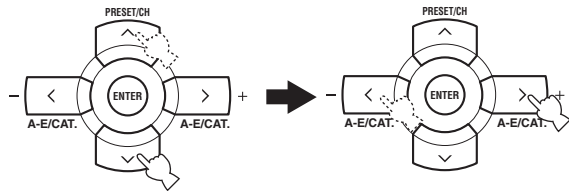

- 1 Set the component selector switch to AMP.

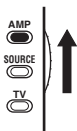

**■ Sound field parameter descriptions**

You can adjust the values of certain digital sound field parameters so that the sound fields are recreated accurately in your listening room. Not all of the following parameters are found in every program.



To change sound field parameter settings to suit your listening environment, see page 65 for details.

Sound field parameter	Features
DSP LEVEL	<p>DSP level. Adjusts the level of all the DSP effect sounds within a narrow range. Depending on the acoustics of your listening room, you may want to increase or decrease the DSP effect level relative to the level of the direct sound.</p> <hr/> <p>Control range: -6 dB to +3 dB</p>
INIT. DLY P. INIT. DLY S. INIT. DLY SB INI. DLY	<p>Initial delay. Presence, surround, and surround back initial delay. Changes the apparent distance from the source sound by adjusting the delay between the direct sound and the first reflection heard by the listener. The smaller the value, the closer the sound source seems to the listener. The larger the value, the farther it seems. For a small room, set to a small value. For a large room, set to a large value.</p> <hr/> <p>Control range: 1 to 99 ms (INIT. DLY and P. INT. DLY)                      1 to 49 ms (S. INIT. DLY and SB INI. DLY)</p>

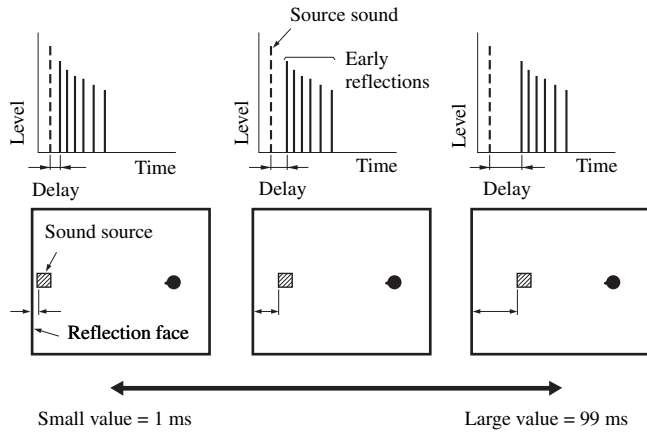

Sound field parameter	Features
-----------------------	----------

ROOM SIZE  
P. ROOM SIZE  
S. ROOM SIZE  
SB RM SIZE

Room size. Presence, surround and surround back room size. Adjusts the apparent size of the surround sound field. The larger the value, the larger the surround sound field becomes. As the sound is repeatedly reflected around a room, the larger the hall is, the longer the time between the original reflected sound and the subsequent reflections. By controlling the time between the reflected sounds, you can change the apparent size of the virtual venue. Changing this parameter from one to two doubles the apparent length of the room.

Control range: 0.1 to 2.0

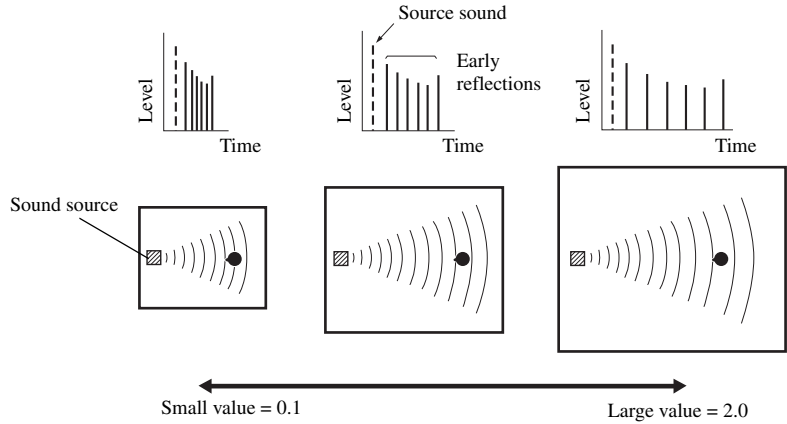

LIVENESS  
S. LIVENESS  
SB LIVENESS

Liveness. Surround and surround back liveness. Adjusts the reflectivity of the virtual walls in the hall by changing the rate at which the early reflections decay. The early reflections of a sound source decay much faster in a room with acoustically absorbent wall surfaces than in one which has highly reflective surfaces. A room with acoustically absorbent surfaces is referred to as “dead”, while a room with highly reflective surfaces is referred to as “live”. This parameter lets you adjust the early reflection decay rate and thus the “liveness” of the room.

Control range: 0 to 10

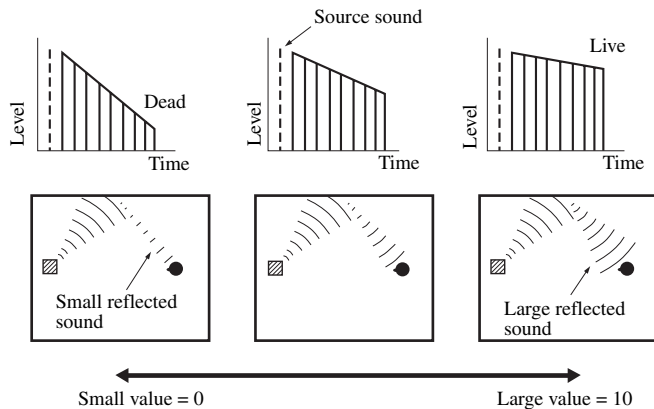

Sound field parameter	Features
-----------------------	----------

REV. TIME

Reverberation time. Adjusts the amount of time taken for the dense, subsequent reverberation sound to decay by 60 dB at 1 kHz. This changes the apparent size of the acoustic environment over an extremely wide range. Set a longer reverberation time for “dead” sources and listening room environments, and a shorter time for “live” sources and listening room environments.

Control range: 1.0 to 5.0 s

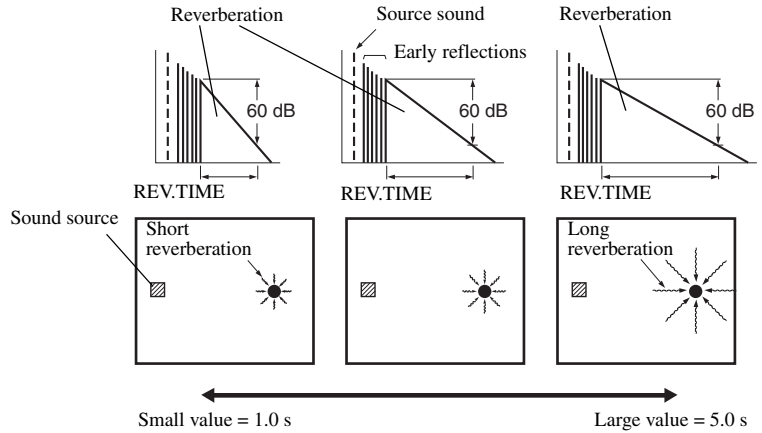

REV. DELAY

Reverberation delay. Adjusts the time difference between the beginning of the direct sound and the beginning of the reverberation sound. The larger the value, the later the reverberation sound begins. A later reverberation sound makes you feel as if you are in a larger acoustic environment.

Control range: 0 to 250 ms

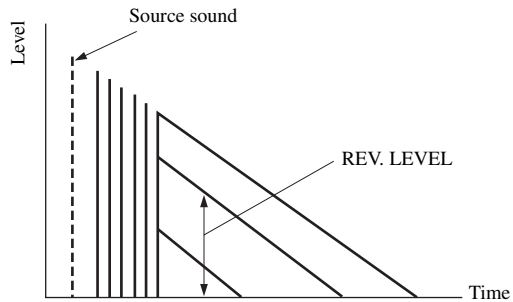



Sound field parameter	Features
REV. LEVEL	<p>Reverberation level. Adjusts the volume of the reverberation sound. The larger the value, the stronger the reverberation becomes.</p> <hr/> <p>Control range: 0 to 100%</p> <hr/>
2ch Stereo DIRECT	<p>2-channel stereo direct. Bypasses the decoders and DSP processors of this unit for pure hi-fi stereo sound when playing 2-channel analog sources.</p> <hr/> <p>Choices: <b>AUTO</b>, OFF</p> <hr/>
<p>☀</p> <ul style="list-style-type: none"> <li>• The “AUTO” setting bypasses the decoders and DSP processors only when “BASS” and “TREBLE” are set to 0 dB (see page 31).</li> <li>• When multi-channel signals (Dolby Digital and DTS) are input, they are downmixed to 2 channels and output from the front left and right speakers.</li> <li>• The low-frequency signals input from the front left and right speakers are redirected to the subwoofer in the following cases: <ul style="list-style-type: none"> <li>– “BASS OUT” is set to “BOTH” (see page 79).</li> <li>– “FRONT” is set to “SMALL” (see page 78) and “BASS OUT” is set to “SWFR” (see page 79).</li> </ul> </li> </ul>	
6ch Stereo CT LEVEL SL LEVEL SR LEVEL SB LEVEL	<p>6-channel stereo center, surround left, surround right, and surround back levels. Adjusts the volume level of each channel in the 6-channel stereo mode.</p> <hr/> <p>Control range: 0 to 100%</p> <hr/>

Sound field parameter	Features
PRO LOGIC IIx Music PRO LOGIC II Music PANORAMA	Pro Logic IIx Music and Pro Logic II Music panorama. Sends stereo signals to the surround speakers as well as the front speakers for a wraparound effect.  Choices: <b>OFF</b> , ON
PRO LOGIC IIx Music PRO LOGIC II Music DIMENSION	Pro Logic IIx Music and Pro Logic II Music dimension. Adjusts the sound field either towards the front or towards the rear.  Control range: -3 (towards the rear) to +3 (towards the front)  Initial setting: STD (standard)
PRO LOGIC IIx Music PRO LOGIC II Music CT WIDTH	Pro Logic IIx Music and Pro Logic II Music center width. Moves the center channel output completely towards the center speaker or towards the front left and right speakers. A larger value moves the center channel output towards the front left and right speakers.  Control range: 0 (center channel sound is output only from the center speaker) to 7 (center channel sound is output only from the front left and right speakers)  Initial setting: 3
DTS Neo:6 Music C. IMAGE	DTS Neo:6 Music center image. Adjusts the front left and right channel output relative to the center channel to make the center channel more or less dominant as necessary.  Control range: 0.0 to 1.0  Initial setting: 0.3



The “Pro Logic IIx Music”, “Pro Logic II Music”, and DTS Neo:6 Music” parameters can be set only when “SUR. STANDARD” is selected. Set the component selector switch to AMP and then press STANDARD on the remote control repeatedly to select “SUR. STANDARD” (see page 41).

## Sound field program speaker layouts

Sound output from each speaker depends on the type of audio signals being input. Refer to the diagrams in the table below to understand the speaker layout for each sound field program.

### Note

Be advised that there may be no or not enough sound output from speakers depending on the type of input source being played back. Furthermore, there may be some channels that can only be used partially when they are adjusted to specific aspects of movies, such as special sound effects, etc.

 Except for "2ch Stereo", "6ch Stereo", and "STRAIGHT", you can select a decoder to output sound from the surround back speaker (see page 40).

The abbreviations and symbols used in each diagram are as follows:

 Front left speaker

 Surround left speaker

 Center speaker



 Surround right speaker

 Front right speaker

 Surround back speaker

 Speaker from which sound is being output

 Speaker from which no sound is being output

\* When the  EX /  PL IIx / ES indicators are turned off in the front panel display

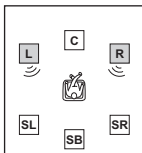
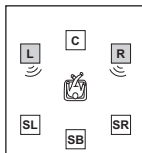
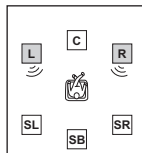
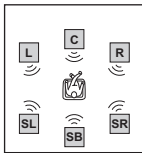
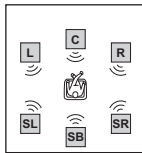
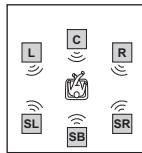
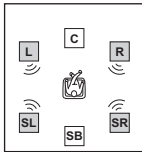
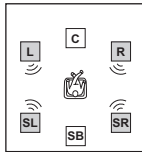
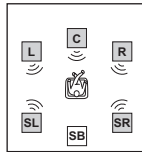
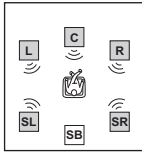
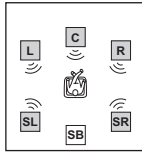
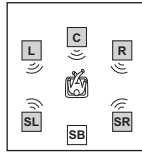
Sound field program	2-channel audio (monaural)	2-channel audio (stereo)	5.1/6.1-channel audio *
STEREO 2ch Stereo			
STEREO 6ch Stereo			
MUSIC Hall in Vienna The Bttm Line The Roxy Thtr ENTERTAINMENT Disco			
MUSIC Pop/Rock ENTERTAINMENT TV Sports Mono Movie Game			

Sound field program	2-channel audio (monaural)	2-channel audio (stereo)	5.1/6.1-channel audio *
MOVIE THEATER Spectacle Sci-Fi Adventure General			
SUR. STANDARD DOLBY DIGITAL PRO LOGIC DTS			
	Pro Logic	Pro Logic	
SUR. STANDARD PLII Movie PLII Music PLII Game PLIIx Movie PLIIx Music PLIIx Game			
	Pro Logic II/Pro Logic IIx	Pro Logic II	
			Pro Logic IIx
SUR. STANDARD Neo:6 Cinema Neo:6 Music			
	Cinema	Cinema/Music	
	Music		
SUR. STANDARD Neural Sur.			

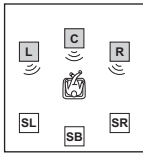
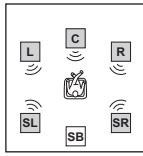
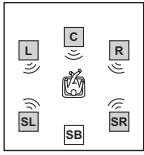
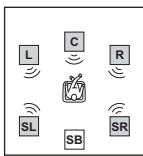
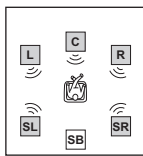
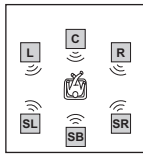
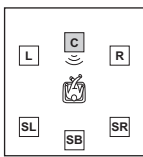
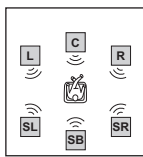
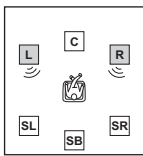
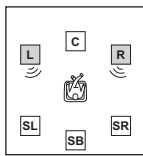
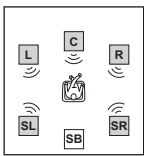
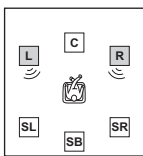
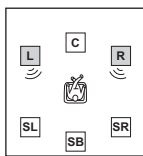
Sound field program	2-channel audio (monaural)	2-channel audio (stereo)	5.1/6.1-channel audio *
SUR. ENHANCED DOLBY DIGITAL PRO LOGIC DTS	 <p data-bbox="482 382 559 407">Pro Logic</p>	 <p data-bbox="771 382 847 407">Pro Logic</p>	
SUR. ENHANCED PLII Movie PLIIx Movie		 <p data-bbox="771 608 847 633">Pro Logic II</p>  <p data-bbox="771 840 847 865">Pro Logic IIx</p>	
SUR. ENHANCED Neo:6 Cinema			
STRAIGHT	 <p data-bbox="482 1275 559 1300">Monaural playback</p>		
DIRECT STEREO	 <p data-bbox="482 1503 559 1528">Monaural playback</p>		

# SET MENU

You can use the following parameters in “SET MENU” to adjust a variety of system settings and customize the way this unit operates. Change the initial settings (indicated in bold under each parameter) to reflect the needs of your listening environment.

## ■ BASIC SETUP BASIC SETUP

Use this feature to set up your system quickly and with minimal effort (see page 27).

## ■ MANUAL SETUP MANUAL SETUP

Use this feature to manually adjust speaker and system parameters.

### Sound menu 1 SOUND MENU

Use this menu to manually adjust any speaker settings, alter the quality and tone of the sound output by the system or compensate for video signal processing delays when using LCD monitors or projectors.

Parameter	Features	Page
A)SPEAKER SET	Selects the size of each speaker, the speakers for low-frequency signal output, and the crossover frequency.	78
B)SP LEVEL	Adjusts the output level of each speaker.	79
C)SP DISTANCE	Adjusts the delay time of each speaker.	80
D)CENTER GEQ	Adjusts the tonal quality of the center speaker.	80
E)LFE LEVEL	Adjusts the output level of the LFE channel for Dolby Digital or DTS signals.	80
F)D. RANGE	Adjusts the dynamic range of Dolby Digital or DTS signals.	81
G)AUDIO SET	Adjusts the muting level, audio delay and tone bypass settings.	81

### Input menu 2 INPUT MENU

Use this menu to manually reassign the input jacks, select the input mode or rename the input source.

Parameter	Features	Page
A)INPUT ASSIGN	Assigns the input jacks of this unit according to the component to be used.	81
B)INPUT MODE	Selects the initial input mode of the source.	82
C)INPUT RENAME	Changes the name of the input source.	82
D)VOLUME TRIM	Adjusts the output volume of each jack.	82

**Option menu 3 OPTION MENU**

Use this menu to manually adjust the optional system parameters.

Parameter	Features	Page
A)DISPLAY SET	Adjusts the brightness of the display.	83
B)MEMORY GUARD	Locks sound field program parameters and other "SET MENU" settings.	83
C)PARAM. INI	Initializes the parameters of a group of sound field programs.	83
D)MULTI ZONE	Specifies the location of the speakers connected to the SPEAKERS B terminals.	83
E)XM RADIO SET	Displays the current reception level of the XM Connect-and-Play digital antenna accessory.	83

**Note**

The "XM RADIO SET" parameter is only applicable to the U.S.A. model.

## Using SET MENU

Use the remote control to access and adjust each parameter.

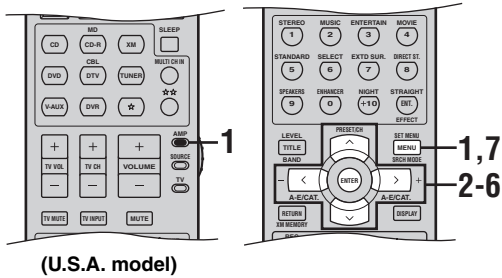

- You can change the “SET MENU” parameters while this unit is reproducing sound.
- If you press one of the sound field program selector buttons during the “SET MENU” operation, the “SET MENU” operation is canceled.
- Repeat the following procedure to select and adjust each parameter setting.
- To return to the previous menu level, press RETURN.

### Note

You cannot change some “SET MENU” parameters when “NIGHT:CINEMA” or “NIGHT:MUSIC” is selected as the night listening mode (see page 32).

- 1 Set the component selector switch to AMP and then press SET MENU to enter “SET MENU”.**

“BASIC SETUP” appears in the front panel display.

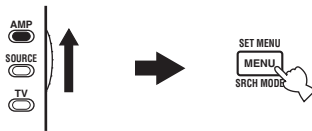

• BASIC SETUP

- 2 Press ^ / v to select “MANUAL SETUP” and then press ENTER.**

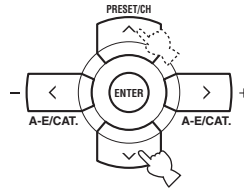

• MANUAL SETUP

- 3 Press ENTER to enter “MANUAL SETUP”.**  
“1 SOUND MENU” appears in the front panel display.

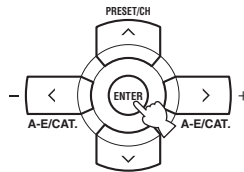

1 SOUND MENU

- 4 Press ^ / v repeatedly and then press ENTER to select and enter the desired menu.**

The following menus appear in the front panel display as you press ^ / v repeatedly.

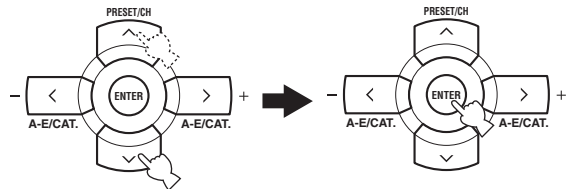

1 SOUND MENU  
↓  
2 INPUT MENU  
↓  
3 OPTION MENU



**5 Press  $\wedge$  /  $\vee$  repeatedly and then press ENTER to select and enter the desired submenu.**

Repeat steps 5 and 6 to navigate to and enter the items you want to adjust.

To return to the previous menu level, press RETURN.

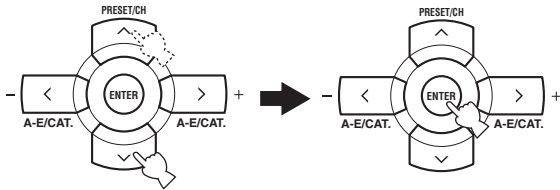

**7 Press SET MENU to exit from "SET MENU".**



**Memory back-up**

The memory back-up circuit prevents the stored data from being lost even if this unit is in the standby mode.

However, the stored data will be lost in case the power cable is disconnected from the AC wall outlet or if the power supply is cut off for more than one week.

**6 Press  $\wedge$  /  $\vee$  to select the desired parameter and then  $\langle$  /  $\rangle$  to change the parameter settings.**

- Press  $\rangle$  to increase the value.
- Press  $\langle$  to decrease the value.

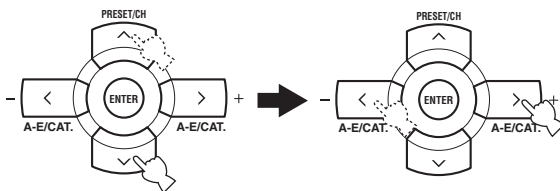

## 1 SOUND MENU

Use this menu to manually adjust any speaker settings or compensate for video signal processing delays when using LCD monitors or projectors.

### ■ Speaker settings A)SPEAKER SET

Use this feature to manually adjust any speaker settings.



If you are not satisfied with the bass sounds from your speakers, you can change these settings according to your preference.

#### Front speakers FRONT

Choices: SMALL, **LARGE**

- Select “SMALL” (small) if you have small front speakers that do not reproduce low-frequency signals effectively. The low-frequency signals of the front left and right channels are directed to the speakers selected in BASS OUT.
- Select “LARGE” (large) if you have large front speakers that reproduce low-frequency signals effectively. All the front left and right channel signals are directed to the front left and right speakers.

#### Note

If “BASS OUT” is set to “FRNT” (see page 79), the LFE signals found in Dolby Digital or DTS sources, the low-frequency signals of the front left and right channels, and the low-frequency signals of other speakers set to “SML” or to “NONE” are all directed to the front left and right speakers regardless of the “FRONT” setting.

#### Center speaker CENTER

Choices: NONE, **SML**, LRG

- Select “NONE” (none) if you did not connect a center speaker. The low-frequency signals of the center channel are directed to the speakers selected in “BASS OUT” (see page 79), and the rest of the center channel signals are directed to the front left and right speakers.
- Select “SML” (small) if you have a small center speaker that does not reproduce low-frequency signals effectively. The low-frequency signals of the center channel are directed to the speakers selected in “BASS OUT” (see page 79).
- Select “LRG” (large) if you have a large center speaker that reproduces low-frequency signals effectively. All the center channel signals are directed to the center speaker.

#### Surround left/right speakers SUR. LR

Choices: NONE, **SML**, LRG

- Select “NONE” (none) if you did not connect surround speakers. This unit is set to the Virtual CINEMA DSP mode (see page 42) and “SUR. B” is automatically set to “NONE” (see below). The low-frequency signals of the surround left and right channels are directed to the speakers selected in “BASS OUT” (see page 79).
- Select “SML” (small) if you have small surround left and right speakers that do not reproduce low-frequency signals effectively. The low-frequency signals of the surround left and right channels are directed to the speakers selected in “BASS OUT” (see page 79).
- Select “LRG” (large) if you have large surround left and right speakers that reproduce low-frequency signals effectively. All the surround channel signals are directed to the surround left and right speakers.

#### Surround back speakers SUR. B

Choices: NONE, **SML**, LRG

- Select “NONE” (none) if you did not connect a surround back speaker. The low-frequency signals of the surround back channel are directed to the speakers selected in “BASS OUT” (see page 79), and the rest of the surround back channel signals are directed to the surround left and right speakers.
- Select “SML” (small) if you have a small surround back speaker that does not reproduce low-frequency signals effectively. The low-frequency signals of the surround back channel are directed to the speakers selected in “BASS OUT” (see page 79).
- Select “LRG” (large) if you have a large surround back speaker that reproduces low-frequency signals effectively. All the surround back channel signals are directed to the surround back speaker.

**LFE/Bass out** BASS OUT

Use this feature to select the speakers that output the LFE (low-frequency effect) and the low-frequency signals.

Choices: SWFR, FRNT, **BOTH**

- Select “SWFR” (subwoofer) if you connected a subwoofer. The LFE signals as well as the low-frequency signals of other speakers set to “SML” (or “SMALL”) or to “NONE” are directed to the subwoofer.
- Select “FRNT” (front) if you did not connect a subwoofer. The LFE signals, the low-frequency signals of the front left and right channels, and the low-frequency signals of other speakers set to “SML” or to “NONE” are all directed to the front left and right speakers regardless of the “FRONT” setting (see page 78).
- Select “BOTH” (both) if you connected a subwoofer. The low-frequency signals of any source are output from the subwoofer. The LFE signals as well as the low-frequency signals of other speakers set to “SML” or to “NONE” are directed to the subwoofer. The low-frequency signals of the front left and right channels are directed to the front left and right speakers regardless of the “FRONT” setting (see page 78).

**Crossover** CROSSOVER

Use this feature to select a crossover frequency of all the speakers set to “SML” (or “SMALL”) or to “NONE” in “SPEAKER SET” (see page 78). All frequencies below the selected frequency will be sent to the subwoofer or to the speakers set to “LRG” (or “LARGE”) in “SPEAKER SET” (see page 78).

Choices: 40Hz, 60Hz, **80Hz**, 90Hz, 100Hz, 110Hz, 120Hz, 160Hz, 200Hz

**Subwoofer phase** SWFR PHASE

Use this feature to switch the phase of your subwoofer if bass sounds are lacking or unclear.

Choices: **NRM**, REV

- Select “NRM” if you do not want to reverse the phase of your subwoofer.
- Select “REV” to reverse the phase of your subwoofer.

**Speaker level** B) SP LEVEL

Use this feature to manually balance the speaker levels between the front left or surround left speakers and each speaker selected in “SPEAKER SET” (see page 78). The selected speaker outputs test tone and the speaker indicator of the speaker flashes.

Control range: -10.0 to +10.0 dB

Control step: 1.0 dB

Initial setting: 0 dB

The following is an example where “FL” is selected to adjust the balance of the front left speaker.

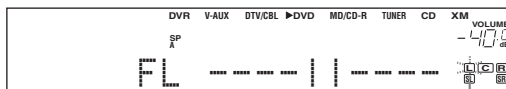

Flashes

- Select “FL” to adjust the balance of the front left speaker.
- Select “FR” to adjust the balance of the front right speaker.
- Select “C” to adjust the balance of the center speaker.
- Select “SL” to adjust the balance of the surround left speaker.
- Select “SR” to adjust the balance of the surround right speaker.
- Select “SB” to adjust the balance of the surround back speaker.
- Select “SWFR” to adjust the balance of the subwoofer.

**Note**

“C”, “SL”, “SR”, “SB” and “SWFR” cannot be adjusted if “CENTER” (see page 78), “SUR. LR” (see page 78), “SUR. B” (see page 78) and “BASS OUT” (see page 79) are set to “NONE” respectively.

## ■ Speaker distance C)SP DISTANCE

Use this feature to manually adjust the distance of each speaker and the delay applied to the respective channel. Ideally, each speaker should be the same distance from the main listening position. However, this is not possible in most home situations. Thus, a certain amount of delay must be applied to the sound from each speaker so that all sounds will arrive at the listening position at the same time.

### Unit UNIT

Choices: meters (m), feet (ft)

Initial setting:

[U.S.A. and Canada models]: feet (ft)

[Other models]: meters (m)

- Select “meters” to adjust speaker distances in meters.
- Select “feet” to adjust speaker distances in feet.

### Speaker distances

Control range: 0.30 to 24.00 m (1.0 to 80.0 ft)

Control step: 0.10 m (0.5 ft)

- Select “FRONT L” to adjust the distance of the front left speaker.  
Initial setting: 3.00 m (10.0 ft)
- Select “FRONT R” to adjust the distance of the front right speaker.  
Initial setting: 3.00 m (10.0 ft)
- Select “CENTER” to adjust the distance of the center speaker.  
Initial setting: 3.00 m (10.0 ft)
- Select “SUR. L” to adjust the distance of the surround left speaker.  
Initial setting: 3.00 m (10.0 ft)
- Select “SUR. R” to adjust the distance of the surround right speaker.  
Initial setting: 3.00 m (10.0 ft)
- Select “SUR. B” to adjust the distance of the surround back speaker.  
Initial setting: 2.10 m (7.0 ft)
- Select “SWFR” to adjust the distance of the subwoofer.  
Initial setting: 3.00 m (10.0 ft)

### Note

“CENTER”, “SUR. L”, “SUR. R”, “SUR. B” and “SWFR” cannot be adjusted if “CENTER” (see page 78), “SUR. LR” (see page 78), “SUR. B” (see page 78) and “BASS OUT” (see page 79) are set to “NONE” respectively.

## ■ Center graphic equalizer D)CENTER GEQ

Use this feature to adjust the built-in 5-frequency band (100Hz, 300Hz, 1kHz, 3kHz and 10kHz) graphic equalizer for the center channel so that the tonal quality of the center speaker matches that of the front speakers. You can make adjustments while listening to the currently selected source component or a test tone.

Control range: -6 to +6 dB

Control step: 0.5 dB

Initial setting: 0 dB



Press  $\wedge$  /  $\vee$  to select a frequency band and  $\langle$  /  $\rangle$  to adjust the selected frequency band.

Following is an example where “100 Hz” is selected as the frequency band.

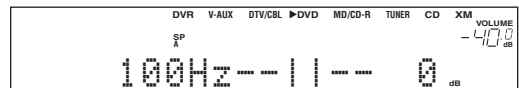

### Test tone TEST

Choices: OFF, ON

- Select “OFF” to stop test tones and output the currently selected source component.
- Select “ON” to output test tones from the front left and center speakers, and adjust the tonal quality of the center speaker.

## ■ Low-frequency effect level E)LFE LEVEL

Use this feature to adjust the output level of the LFE (low-frequency effect) channel according to the capacity of your subwoofer or headphones. The LFE channel carries low-frequency special effects which are only added to certain scenes. This setting is effective only when this unit decodes Dolby Digital or DTS signals.

Control range: -20 to 0 dB

Control step: 1 dB

### Speaker SP LFE

Adjusts the speaker LFE level.

### Headphone HP LFE

Adjusts the headphone LFE level.

### Note

Depending on the settings of “BASS OUT” (see page 79), some signals may not be output at the SUBWOOFER OUTPUT jack.

## ■ Dynamic range F)D. RANGE

Use this feature to select the amount of dynamic range compression to be applied to your speakers or headphones. This setting is effective only when this unit is decoding Dolby Digital and DTS signals.

### Speaker SP D.R

Adjusts the speaker compression.

### Headphone HP D.R

Adjusts the headphone compression.

Choices: MIN, STD, **MAX**

- Select "MIN" (minimum) if you regularly listen at low volume levels.
- Select "STD" (standard) for general use.
- Select "MAX" (maximum) to preserve the greatest amount of dynamic range.

## ■ Audio settings G)AUDIO SET

Use this feature to adjust the overall audio settings of this unit.

### Muting type MUTE TYP.

Use this feature to adjust how much the mute function reduces the output volume (see page 32).

Choices: **FULL**, -20dB

- Select "FULL" to completely mute all the audio output.
- Select "-20dB" to reduce the current volume by 20 dB.

### Audio delay A.DELAY

Use this feature to delay the sound output and synchronize it with the video image. This may be necessary when using certain LCD monitors or projectors.

Control range: **0** to 160 ms

Control step: 1 ms

### Tone bypass TC.BYPASS

Use this feature to select whether audio output bypasses tone control circuitry when "TREBLE" and "BASS" are set to 0 dB (see page 31).

Choices: **AUTO**, OFF

- Select "AUTO" if you want signals to bypass tone control circuitry to provide the purest signal possible.
- Select "OFF" if you do not want signals to bypass tone control circuitry.

## 2 INPUT MENU

Use this menu to reassign the input jacks, select the input mode or rename the input source.

## ■ Input assignment

### A) INPUT ASSIGN

Use this feature to assign the input jacks according to the component to be used if the initial settings of this unit do not correspond to your needs. Change the following parameters to reassign the respective jacks and effectively connect more components.

Once the input jacks are reassigned, you can select the corresponding component by using the INPUT selector on the front panel (or the input selector buttons on the remote control).

### For COMPONENT VIDEO jacks A, B and C

C.V[A]

C.V[B]

C.V[C]

Choices: [A] **DVD**, DTV/CBL, V-AUX, DVR

[B] DVD, **DTV/CBL**, V-AUX, DVR

[C] DVD, DTV/CBL, V-AUX, **DVR**

### For OPTICAL INPUT jacks 1 and 2

IN (1)

IN (2)

Choices: (1) CD, MD/CD-R, **DVD**, DTV/CBL, V-AUX, DVR

(2) CD, MD/CD-R, DVD, **DTV/CBL**, V-AUX, DVR

### For COAXIAL INPUT jack 3 COAXIAL IN (3)

Choices: (3) CD, MD/CD-R, **DVD**, DTV/CBL, V-AUX, DVR

### Notes

- You cannot select a specific item more than once for the same type of jack.
- When you connect a component to both the DIGITAL INPUT (COAXIAL) and DIGITAL INPUT (OPTICAL) jacks, priority is given to the signals input at the DIGITAL INPUT (COAXIAL) jack.

**Input mode** B)INPUT MODE

Use this feature to set this unit to reset “INPUT MODE” back to “AUTO” (see page 33) regardless of the previous setting or to recall the last input mode (“AUTO”, “DTS”, or “ANALOG”) used for that source whenever you turn on this unit.

Choices: **AUTO**, **LAST**

- Select “AUTO” to reset “INPUT MODE” back to “AUTO” (see page 33) regardless of the previous setting whenever you turn on this unit. This unit automatically selects input signals in the following order:
  - (1) Digital signals
  - (2) Analog signals
- Select “LAST” to set this unit to automatically recall the last input mode (“AUTO”, “DTS”, or “ANALOG”) used for that source whenever you turn on this unit.

**Input rename** C)INPUT RENAME

Use this feature to change the name of the input source that appears in the front panel display.

The following is an example where “DVD” is renamed “My DVD”.



- 1 Press one of the input selector buttons on the remote control to select the input source you want to change the name of.**

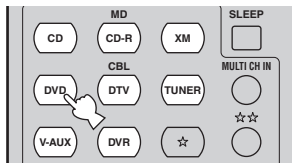

- 2 Set the component selector switch to AMP and then press </> on the remote control to place the “\_” (underscore) under the space or the character you want to edit.**

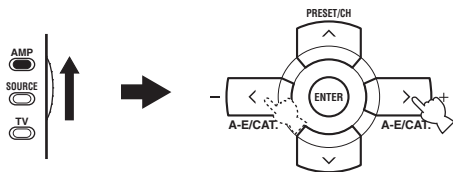

- 3 Press ^ / v to select the character you want to use and then press </> to move to the next space.**

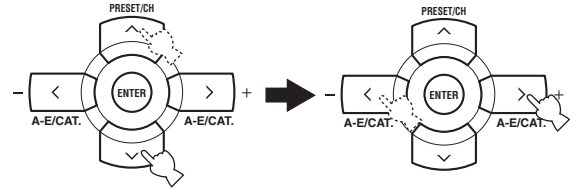

**Notes**

- You can use up to 8 characters for each input.
- Press v to change the character in the following order, or press ^ to go in the reverse order:  
A to Z, a space, 0 to 9, a space, a to z, a space, symbols (#, \*, -, +, etc.)

- 4 Repeat steps 1 through 3 to rename each input source.**

- 5 Press SET MENU on the remote control to exit from “INPUT RENAME”.**



**Volume Trim** D)VOLUME TRIM

Use this feature to adjust the level of the signal input at each jack. This is useful if you want to balance the level of each input source to avoid sudden changes in volume when switching between input sources.

Choices: CD, MD/CD-R, TUNER, DVD, DTV/CBL, V-AUX, DVR

Control range: -6.0 to 6.0 dB

Control step: 1.0 dB

Initial setting: 0.0 dB

## 3 OPTION MENU

Use this menu to adjust the optional system parameters.

### ■ Display settings A) DISPLAY SET

#### Dimmer DIMMER

Use this feature to adjust the brightness of the front panel display.

Control range: -4 to 0

Control step: 1

- Press < to make the front panel display dimmer.
- Press > to make the front panel display brighter.

### ■ Memory guard B) MEMORY GUARD

Use this feature to prevent accidental changes to DSP program parameter values and other system settings.

Choices: **OFF**, **ON**

- Select “OFF” to turn off the “MEMORY GUARD” feature.
- Select “ON” to protect:
  - DSP program parameters
  - All “SET MENU” items
  - All speaker levels

#### Note

When “MEMORY GUARD” is set to “ON”, you cannot select and adjust any other “SET MENU” items.

### ■ Parameter initialization C) PARAM. INI

Use this feature to initialize the parameters of each sound field program within a sound field program group. When you initialize a sound field program group, all of the parameter values within that group revert to their initial factory settings.

Press the corresponding sound field program selector buttons on the remote control to select the sound field program that you want to initialize.

Choices: **STEREO**, **MUSIC**, **ENTERTAINMENT**, **MOVIE THEATER**, **STANDAND**

#### Notes

- You cannot automatically revert to the previous parameter settings once you initialize a sound field program group.
- You cannot separately initialize individual sound field programs.
- You cannot initialize any sound field program groups when “MEMORY GUARD” is set to “ON”.

### ■ Zone set D) MULTI ZONE

Use this feature to specify the location of speakers connected to the SPEAKERS B terminals of this unit.

#### Speaker B setting SP B

Use this feature to select the location of the front speakers connected to the SPEAKERS B terminals.

Choices: **FRONT**, **ZONE B**

- Select “FRONT” to turn on or off SPEAKERS A and B when the speakers connected to the SPEAKERS B terminals are set in the main zone.
- Select “ZONE B” if the speakers connected to the SPEAKERS B terminals are set in another zone. If SPEAKERS A is turned off and SPEAKERS B is turned on, all the speakers in the main zone are muted and this unit outputs sound at the SPEAKERS B terminals only.

#### Notes

- If you connect headphones to the PHONES jack of this unit, the sound is output from both headphones and the SPEAKERS B terminals when “SP B” is set to “ZONE B”.
- If a DSP program is selected when “SP B” is set to “ZONE B”, this unit automatically enters the Virtual CINEMA DSP mode (see page 42).

### ■ XM Radio setting E) XM RADIO SET (U.S.A model only)

#### XM Radio antenna XM ANT.

Use this feature to check the current reception level of the XM Connect-and-Play digital antenna accessory connected to the XM jack of this unit (see page 51). For the best reception, orient the XM Connect-and-Play digital antenna accessory so that a value of 60% or more is displayed here.

Display status: **NONE**, 0 to 100%

#### Notes

- “NONE” is displayed if the XM Connect-and-Play digital antenna accessory is not connected to this unit. In this case, check the antenna connections (see page 51).
- The “XM ANT.” parameter cannot be adjusted by using the remote control. Instead, you need to adjust the orientation of the XM Connect-and-Play digital antenna accessory connected to the XM jack of this unit for a better percentage of the reception level.

#### XM Radio information display scroll SCROLL

Use this feature to set whether to display the XM Satellite Radio information in the front panel display in continuous manner pr by 14 alphanumeric characters at once (see page 60).

Choices: **CONT**, **ONCE**

- Select “CONT” to display the XM Satellite Radio information in the front panel display in a continuous manner.
- Select “ONCE” to display the XM Satellite Radio information in the front panel display by 14 alphanumeric characters at once.

# ADVANCED SETUP

This unit has additional menus that are displayed in the front panel display. The advanced setup menu offers additional operations to adjust and customize the way this unit operates. Change the initial settings (indicated in bold under each parameter) to reflect the needs of your listening environment.

## Notes

- The settings you make are reflected next time you turn on this unit by pressing **STANDBY/ON** on the front panel (or **POWER** on the remote control) (see page 26).
- Only **STANDBY/ON**, **STRAIGHT (EFFECT)** and the **PROGRAM </>** buttons are effective while you are using the advanced setup menu.
- All the other operations cannot be made while you are using the advanced setup menu.
- The advanced setup menu is only available in the front panel display.

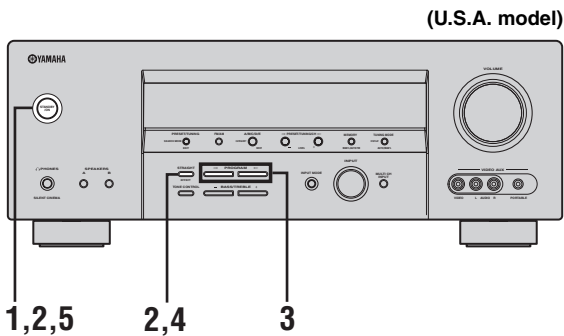

**1 Press STANDBY/ON on the front panel to set this unit to the standby mode.**



**2 Press and hold STRAIGHT (EFFECT) on the front panel and then press STANDBY/ON to turn on this unit.**

This unit turns on, and the advanced setup menu appears in the front panel display.

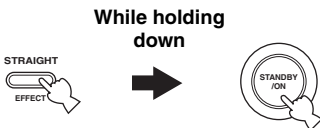

**3 Press the PROGRAM </> buttons on the front panel repeatedly to select the parameter you want to adjust.**

The name of the selected parameter appears in the front panel display.

See page 85 for a complete list of available parameters.

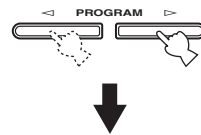

Currently selected parameter

Currently selected parameter setting



**4 Press STRAIGHT (EFFECT) on the front panel repeatedly to change the selected parameter setting.**



**5 Press STANDBY/ON on the front panel to save the new setting and set this unit to the standby mode.**



The settings you made are reflected next time you turn on this unit.



**Speaker impedance** SP IMP.

Use this feature to set the speaker impedance of this unit so that it matches that of your speakers.

Choices: **8ΩMIN**, **6ΩMIN**

- Select “8ΩMIN” to set the speaker impedance to 8 Ω.
- Select “6ΩMIN” to set the speaker impedance to 6 Ω.

SP IMP.	Speaker	Impedance level
8ΩMIN	Front	If you use one set (A or B), the impedance of each speaker must be 8 Ω or higher.
	Center	If you use two sets (A and B), the impedance of each speaker must be 16 Ω or higher.*
	Surround	The impedance of each speaker must be 8 Ω or higher.
	Surround back	
6ΩMIN	Front	If you use one set (A or B), the impedance of each speaker must be 6 Ω or higher.
	Center	If you use two sets (A and B), the impedance of each speaker must be 12 Ω or higher.
	Surround	The impedance of each speaker must be 6 Ω or higher.
	Surround back	

\* The Canada model cannot use two separate speaker systems (A and B) simultaneously when “SP IMP.” is set to “8ΩMIN”.

**Factory presets** PRESET

Use this feature to reset all the parameters of this unit to the initial factory settings (see page 91).

Choices: **CANCEL**, **RESET**

- Select “CANCEL” not to reset any parameters of this unit.
- Select “RESET” to reset the parameters of this unit.

**Notes**

- This setting completely resets all the parameters of this unit including the “SET MENU” parameters. However, the advanced setup menu parameters will not be initialized.
- The initial factory settings are activated next time you turn on this unit.

**Remote control AMP ID** REMOTE AMP

Use this feature to set the AMP ID of this unit for remote control recognition (see page 89).

Choices: **ID1**, **ID2**

- Select “ID1” when the remote control AMP ID library code is set to “00001”.
- Select “ID2” when the remote control AMP ID library code is set to “00002”.

**Note**

You need to set the corresponding remote control AMP library code for the remote control (see page 89).

**Remote control TUNER ID** REMOTE TUN

Use this feature to set the TUNER ID of this unit for remote control recognition (see page 89).

Choices: **ID1**, **ID2**

- Select “ID1” when the remote control TUNER ID library code is set to “81916”.
- Select “ID2” when the remote control TUNER ID library code is set to “81917”.

**Note**

You need to set the corresponding remote control TUNER library code for the remote control (see page 89).

**Remote control XM ID** REMOTE XM  
(U.S.A. model only)

Use this feature to set the XM ID of this unit for remote control recognition (see page 90).

Choices: **ID1**, **ID2**

- Select “ID1” when the remote control XM ID library code is set to “81918”.
- Select “ID2” when the remote control XM ID library code is set to “81919”.

**Note**

You need to set the corresponding remote control XM library code for the remote control (see page 89).

**Tuner frequency step** TU  
(Asia and General models only)

Use this feature to set the tuner frequency step according to the frequency spacing in your area.

Choices: **AM10/FM100**, **AM9/FM50**

- Select “AM10/FM100” for North, Central and South America.
- Select “AM9/FM50” for all other areas.

# REMOTE CONTROL FEATURES

In addition to controlling this unit, the remote control can also operate other audiovisual components made by YAMAHA and other manufacturers. To control your TV or other components, you must set the appropriate remote control code for each input source (see page 88).

## Controlling this unit, a TV, or other components

### ■ Controlling this unit

Set the component selector switch to AMP to control this unit.

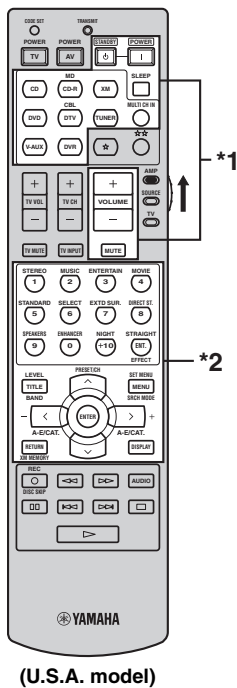

### ■ Controlling a TV

Set the component selector switch to TV to control your TV. To control your YV, you must set the appropriate remote control code for DTV/CBL or ☆☆ (see page 88). When you set the remote control codes for both DTV/CBL and ☆☆, priority is given to the one set for DTV/CBL.

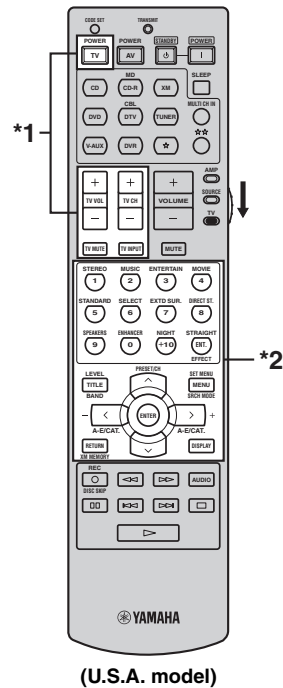

#### Notes

- \*1 These buttons always control this unit regardless of the component selector switch position.
- \*2 These buttons control this unit only when the component selector switch is set to AMP.

#### Notes

- \*1 These buttons always control your TV regardless of the component selector switch position.

Remote control	Digital TV/Cable TV
TV POWER	Turns on or off the power.
TV VOL +/-	Increases or decreases the volume level.
TV CH +/-	Changes the channel number.
TV MUTE	Mutes the audio output.
TV INPUT	Changes the input source.

- \*2 These buttons control your TV only when the component selector switch is set to TV. For details, see the "Digital TV/Cable TV" column on page 87.

### ■ Controlling other components

Set the component selector switch to SOURCE to control other components selected with the input selector buttons, ☆, or ☆☆. You must set the appropriate remote control code for each input source (see page 88). The following table shows the function of each control button used to control other components assigned to each input selector button, ☆, and ☆☆. Be advised that some buttons may not correctly operate the selected component.

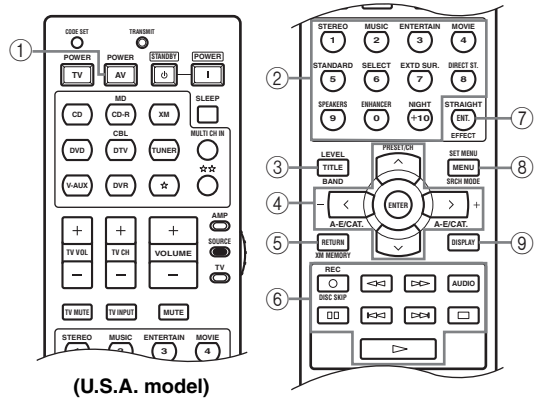

Remote control	DVD player/recorder	VCR	Digital TV/Cable TV	LD player	CD player	MD/CD recorder	Tuner
① AV POWER	Power *1	Power *1	Power *2	Power *1	Power *1	Power *1	Power *1
② 1-9, 0, +10	Numeric buttons	Numeric buttons	Numeric buttons	Numeric buttons	Numeric buttons	Numeric buttons	Preset stations (1-8)
③ TITLE	Title						Band
④ PRESET/CH ^	Up	VCR channel up	Up				Preset up (1-8)
PRESET/CH v	Down	VCR channel down	Down				Preset down (1-8)
A-E/CAT. <	Left		Left				Preset down (A-E)
A-E/CAT. >	Right		Right				Preset up (A-E)
ENTER	Enter		Enter				
⑤ RETURN	Return		Return				
⑥ REC/DISC SKIP	Disc skip (player) Rec (recorder) *3	Rec *3	Rec *2*3		Disc skip	Rec *3	
▷	Play	Play	Play *2	Play	Play	Play	
◀◀	Search backward	Search backward	Search backward *2	Search backward	Search backward	Search backward	
▶▶	Search forward	Search forward	Search forward *2	Search forward	Search forward	Search forward	
AUDIO	Audio	Audio	Audio *2	Sound			
⏸	Pause	Pause	Pause *2	Pause	Pause	Pause	
◀◀◀	Skip backward	Skip backward	Skip backward *2	Skip backward	Skip backward	Skip backward	
▶▶▶	Skip forward	Skip forward	Skip forward *2	Skip forward	Skip forward	Skip forward	
◻	Stop	Stop	Stop *2	Stop	Stop	Stop	
⑦ ENT.	Title/Index	Enter	Enter	Chapter/Time	Index	Index	
⑧ MENU	Menu		Menu				
⑨ DISPLAY	Display	Display	Display	Display	Display	Display	

#### Notes

- \*1 This button is operational only when the original remote control supplied with the component has a POWER button.
- \*2 These buttons control your VCR or DVD recorder only when you set the appropriate remote control code for DVR (see page 88).
- \*3 When you use this button to record a source, press it twice repeatedly to prevent a malfunction.

## Setting remote control codes

You can control your TV and other components by setting the appropriate remote control code for each input source. For a complete list of available remote control codes, refer to “LIST OF REMOTE CONTROL CODES” at the end of this manual.

The following table shows the default component in the “Library” (component category) column and the remote control code for each input source.

### Remote Control Code Default Settings

Input source	Library (component category)	Manufacturer	Default code
CD	CD	YAMAHA	61907
MD/CD-R	MD	YAMAHA	70888
XM	TUNER	YAMAHA	81918
DVD	DVD	YAMAHA	40539
DTV/CBL	–	–	–
TUNER	TUNER	YAMAHA	81916
V-AUX	–	–	–
DVR	DVR	YAMAHA	51544
☆	–	–	–
☆☆	–	–	–

#### Note

You may not be able to operate your YAMAHA component even if a YAMAHA remote control code is initially set as listed above. In this case, try setting other YAMAHA remote control codes.

- 1 Press one of the input selector buttons or ☆/☆☆ to select the component you want to set up.

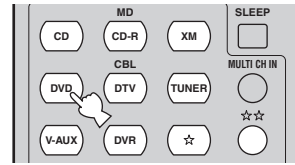

- 2 Press CODE SET using a ballpoint pen or a similar object.

The TRANSMIT indicator on the remote control flashes twice.



- 3 Press the numeric buttons (0 to 9) to enter the five-digit remote control code for the component to be used.

The TRANSMIT indicator on the remote control flashes twice, and the remote control code for the selected component is set.

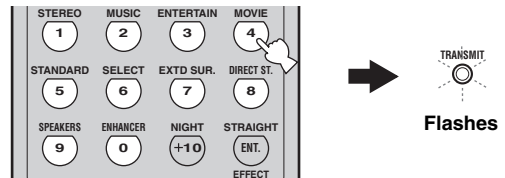

Refer to “LIST OF REMOTE CONTROL CODES” at the end of this manual.

#### Notes

- If the manufacturer of your component has more than one code, try each of them until you find the correct one.
- If you do not press any buttons within 30 seconds in step 3, the setup procedure is canceled. If this happens, repeat the setup procedure.
- If you enter the code number “9980”, the remote control code previously set for the selected component is cleared.

## Setting library codes

You can operate multiple YAMAHA receivers or amplifiers in the same room with the supplied remote control simultaneously. Set the appropriate library code to select and operate the desired component with the supplied remote control.

### Setting remote control AMP ID library codes

Select one of the following codes to set the remote control AMP ID library code for the component you want to use.

#### 1 Press CODE SET using a ballpoint pen or a similar object.

The TRANSMIT indicator on the remote control flashes twice.



#### 2 Press the numeric buttons to enter the code number "00001" or "00002".

The TRANSMIT indicator on the remote control flashes twice, and the AMP ID library code is changed.

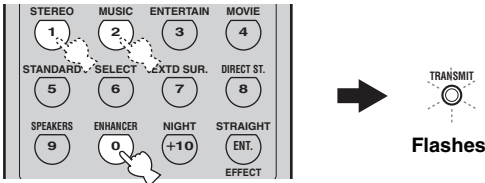

AMP ID library code *1	Function	Remote control AMP ID *2
00001 (initial setting)	To operate this unit using the default code.	ID1 (initial setting)
00002	To operate this unit using an alternative code.	ID2

\*1 The remote control setting

\*2 The setting of this unit (see page 85)

#### Notes

- You need to set the corresponding remote control AMP ID of this unit in the advanced setup (see page 85).
- When using multiple YAMAHA receivers/amplifiers, you may be able to operate the other components simultaneously with the default code setting. In this case, set one of the alternative codes to operate this unit separately.

### Setting remote control TUNER ID library codes

Select one of the following codes to set the remote control TUNER ID library code for the component you want to use.

#### 1 Press TUNER to select "TUNER" as the input source.



#### 2 Press CODE SET using a ballpoint pen or a similar object.

The TRANSMIT indicator on the remote control flashes twice.



#### 3 Press the numeric buttons to enter the code number "81916" or "81917".

The TRANSMIT indicator on the remote control flashes twice, and the TUNER ID library code is changed.

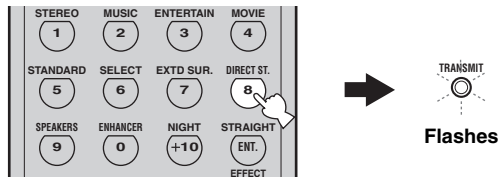

TUNER ID library code *1	Function	Remote control TUNER ID *2
81916 (initial setting)	To operate this unit using the default code.	ID1 (initial setting)
81917	To operate this unit using an alternative code.	ID2

\*1 The remote control setting

\*2 The setting of this unit (see page 85)

#### Notes

- You need to set the corresponding remote control TUNER ID of this unit in the advanced setup (see page 85).
- When using multiple YAMAHA receivers/amplifiers, you may be able to operate the other components simultaneously with the default code setting. In this case, set one of the alternative codes to operate this unit separately.

**■ Setting remote control XM ID library codes (U.S.A. model only)**

Select one of the following codes to set the remote control XM ID library code for the component you want to use.

**1 Press XM to select “XM” as the input source.**



**2 Press CODE SET using a ballpoint pen or a similar object.**

The TRANSMIT indicator on the remote control flashes twice.



**3 Press the numeric buttons to enter the code number “81918” or “81919”.**

The TRANSMIT indicator on the remote control flashes twice, and the XM ID library code is changed.

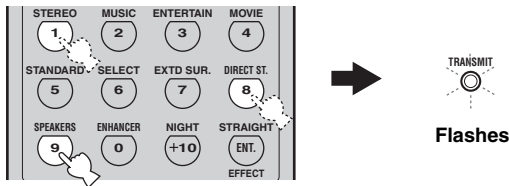

XM ID library code *1	Function	Remote control XM ID *2
81918 (initial setting)	To operate this unit using the default code.	ID1 (initial setting)
81919	To operate this unit using an alternative code.	ID2

\*1 The remote control setting

\*2 The setting of this unit (see page 85)

**Notes**

- You need to set the corresponding remote control XM ID of this unit in the advanced setup(see page 85).
- When using multiple YAMAHA receivers/amplifiers, you may be able to operate the other components simultaneously with the default code setting. In this case, set one of the alternative codes to operate this unit separately.

**Resetting all remote control codes**

Use this feature to clear all the remote control codes previously set and reset all of them to the initial factory settings.

**1 Press CODE SET using a ballpoint pen or a similar object.**

The TRANSMIT indicator on the remote control flashes twice.



**2 Press the numeric buttons to enter the code number “9981”.**

The TRANSMIT indicator on the remote control flashes twice, and all the remote control codes previously set are cleared and reset to the initial factory settings.

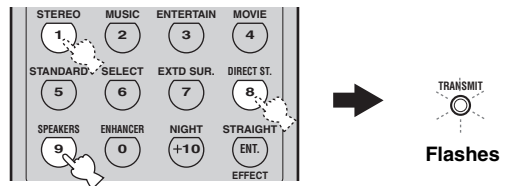

If you do not press any buttons within 30 seconds after step 2, the clearing process is canceled. In this case, repeat the clearing procedure.

# RESETTING THE SYSTEM

Use this feature to reset all the parameters of this unit to the initial factory settings.

## Notes

- This procedure completely resets all the parameters of this unit including the “SET MENU” parameters. However, the advanced setup menu parameters will not be initialized.
- The initial factory settings are activated next time you turn on this unit.

 To cancel the initialization procedure at any time without making any changes, press STANDBY/ON on the front panel (or STANDBY on the remote control) to set this unit to the standby mode.

(U.S.A. model)

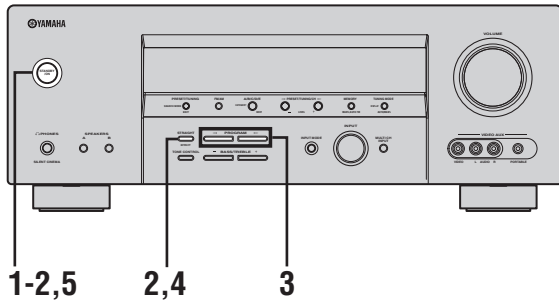

- 1 Press STANDBY/ON on the front panel to set this unit to the standby mode.**



- 2 Press and hold STRAIGHT (EFFECT) on the front panel and then press STANDBY/ON to turn on this unit.**

This unit turns on, and the advanced setup menu appears in the front panel display.



- 3 Press the PROGRAM </> buttons on the front panel to select “PRESET”.**



PRESET-CANCEL

- 4 Press STRAIGHT (EFFECT) on the front panel repeatedly to select “RESET”.**



PRESET-RESET



Select “CANCEL” to cancel the initialization procedure without making any changes.

- 5 Press STANDBY/ON on the front panel to confirm your selection and set this unit to the standby mode.**



# TROUBLESHOOTING

Refer to the table below when this unit does not function properly. If the problem you are experiencing is not listed below or if the instruction below does not help, set this unit to the standby mode, disconnect the power cable, and contact the nearest authorized YAMAHA dealer or service center.

## ■ General

Problem	Cause	Remedy	See page
<b>This unit fails to turn on or enters the standby mode soon after the power is turned on.</b>	The power cable is not connected or the plug is not completely inserted.	Connect the power cable firmly.	—
	The speaker impedance setting is incorrect.	Set the speaker impedance to match your speakers.	25
	The protection circuitry has been activated.	Make sure that all speaker wire connections on this unit and on all speakers are secure and that the wire for each connection does not touch anything other than its respective connection.	13
	This unit has been exposed to a strong external electric shock (such as lightning or strong static electricity).	Set this unit to the standby mode, disconnect the power cable, plug it back in after 30 seconds and then use it normally.	—
<b>No sound</b>	Incorrect input or output cable connections.	Connect the cables properly. If the problem persists, the cables may be defective.	18-24
	“INPUT MODE” is set to “DTS” or “ANALOG”.	Set “INPUT MODE” to “AUTO”.	33
	No appropriate input source has been selected.	Select an appropriate input source with the INPUT selector on the front panel (or the input selector buttons on the remote control) and MULTI CH INPUT on the front panel (or MULTI CH IN on the remote control).	30, 37
	Speaker connections are not secure.	Secure the connections.	13
	The front speakers to be used have not been selected properly.	Select the set of front speakers with SPEAKERS A/B on the front panel or SPEAKERS on the remote control.	30
	The volume is turned down.	Turn up the volume.	—
	The sound is muted.	Press MUTE or VOLUME +/- on the remote control to resume audio output and then adjust the volume.	32
	“INPUT MODE” is set to “ANALOG” while playing a source encoded in DTS.	Set “INPUT MODE” to “AUTO” or “DTS”.	33
	Signals this unit cannot reproduce are being input from a source component, such as a CD-ROM.	Play a source whose signals can be reproduced by this unit.	—
<b>No picture</b>	The output and input for the picture are connected to different types of video jacks.	Connect your video source components in the same way as you connect your video monitor to this unit.	19



Problem	Cause	Remedy	See page
<b>The sound suddenly goes off.</b>	The protection circuitry has been activated because of a short circuit, etc.	Check that the speaker impedance setting is correct.	25
		Check that the speaker wires are not touching each other and then turn this unit back on.	—
	The sleep timer has turned off this unit.	Turn on this unit, and play the source again.	—
	The sound is muted.	Press MUTE or VOLUME +/- on the remote control to resume audio output.	32
<b>Sound is heard from the speaker on one side only.</b>	Incorrect cable connections.	Connect the cables properly. If the problem persists, the cables may be defective.	18-24
	Incorrect settings in “SPEAKER LEVEL”.	Adjust the “SPEAKER LEVEL” settings.	79
<b>Only the center speaker outputs substantial sound.</b>	When playing a monaural source with a CINEMA DSP program, the source signal is directed to the center channel, and the front and surround speakers output effect sounds.		
<b>No sound is heard from the center speaker.</b>	“CENTER” in “SET MENU” is set to “NONE”.	Set “CENTER” to “SML” or “LRG”.	78
	One of the HiFi DSP programs (except for 6ch Stereo) has been selected.	Try another sound field program.	62
<b>No sound is heard from the surround speakers.</b>	“SUR. LR” in “SET MENU” is set to “NONE”.	Set “SUR. LR” to “SML” or “LRG”.	78
	This unit is in the “STRAIGHT” mode and a monaural source is being played back.	Press STRAIGHT (EFFECT) on the front panel so that “STRAIGHT” disappears from the front panel display.	37
<b>No sound is heard from the surround back speaker.</b>	“SUR. LR” in “SET MENU” is set to “NONE” and “SUR. B” is automatically set to “NONE”.	Set “SUR. LR” and “SUR. B” to “SML” or “LRG”.	78
	“SUR. B” in “SET MENU” is set to “NONE”.	Set “SUR. B” to “SML” or “LRG”.	78
<b>No sound is heard from the subwoofer.</b>	“BASS OUT” in “SET MENU” is set to “FRNT” when a Dolby Digital or DTS signal is being played.	Set “BASS OUT” to “SWFR” or “BOTH”.	79
	“BASS OUT” in “SET MENU” is set to “SWFR” or “FRNT” when a 2-channel source is being played.	Set “BASS OUT” to “BOTH”.	79
	The source does not contain low-frequency bass signals.		

Problem	Cause	Remedy	See page
<b>Dolby Digital or DTS sources cannot be played. (Dolby Digital or DTS indicator in the front panel display does not light up.)</b>	The connected component is not set to output Dolby Digital or DTS digital signals.	Make an appropriate setting following the operating instructions for your component.	—
	“INPUT MODE” is set to “ANALOG”.	Set “INPUT MODE” to “AUTO” or “DTS”.	33
<b>A humming sound is heard.</b>	Incorrect cable connections.	Connect the audio cables firmly. If the problem persists, the cables may be defective.	—
<b>The volume level cannot be increased, or the sound is distorted.</b>	The component connected to the AUDIO OUT (REC) jacks of this unit is turned off.	Turn on the power of the component.	—
<b>The sound effect cannot be recorded.</b>	It is not possible to record the sound effect with a recording component.		
<b>A source cannot be recorded by an analog component connected to the AUDIO OUT (REC) jacks.</b>	The source component is not connected to the analog AUDIO IN jacks of this unit.	Connect the source component to the analog AUDIO IN jacks.	19-21
<b>The sound field parameters and some other settings of this unit cannot be changed.</b>	“MEMORY GUARD” in “SET MENU” is set to “ON”.	Set “MEMORY GUARD” to “OFF”.	83
<b>This unit does not operate properly.</b>	The internal microcomputer has been frozen by an external electric shock (such as lightning or excessive static electricity) or by a power supply with low voltage.	Disconnect the power cable from the AC wall outlet and then plug it in again after about 30 seconds.	—
<b>“CHECK SP WIRES” appears in the front panel display.</b>	Speaker cables are short-circuited.	Make sure all speaker cables are connected correctly.	13
<b>There is noise interference from digital or radio frequency equipment.</b>	This unit is too close to the digital or high-frequency equipment.	Move this unit further away from such equipment.	—
<b>The picture is disturbed.</b>	The video source uses scrambled or encoded signals to prevent dubbing.		
<b>This unit suddenly enters the standby mode.</b>	The internal temperature becomes too high and the overheat protection circuitry has been activated.	Wait about 1 hour for this unit to cool down and then turn it back on.	—

## ■ Tuner

	Problem	Cause	Remedy	See page
FM	FM stereo reception is noisy.	The characteristics of FM stereo broadcasts may cause this problem when the transmitter is too far away or the antenna input is poor.	Check the antenna connections.	23
			Try using a high-quality directional FM antenna.	—
			Use the manual tuning method.	45
	There is distortion, and clear reception cannot be obtained even with a good FM antenna.	There is multi-path interference.	Adjust the antenna position to eliminate multi-path interference.	—
FM	The desired station cannot be tuned into with the automatic tuning method.	The signal is too weak.	Use a high-quality directional FM antenna.	—
			Use the manual tuning method.	45
	Previously preset stations can no longer be tuned into.	This unit has been disconnected for a long period.	Set preset stations	46, 47
AM	The desired station cannot be tuned into with the automatic tuning method.	The signal is weak or the antenna connections are loose.	Tighten the AM loop antenna connections and orient it for the best reception.	—
			Use the manual tuning method.	45
	There are continuous crackling and hissing noises.	Noises result from lightning, fluorescent lamps, motors, thermostats and other electrical equipment.	Use an outdoor antenna and a ground wire. This will help somewhat, but it is difficult to eliminate all noise.	—
			There are buzzing and whining noises.	A TV set is being used nearby.

## ■ XM Satellite Radio (U.S.A. model only)

If an operation takes longer than usual or an error occurs, one of the following messages may appear in the front panel display. In this case, read the cause and follow the corresponding remedies.

Status message	Cause	Remedy	See page
CHECK ANTENNA	The XM Connect-and-Play digital antenna is not connected to the XM jack of this unit or does not work properly.	Check the XM Connect-and-Play digital antenna accessory connections and orient it for the best reception level.	51
UPDATING	The XM user encryption code is being updated.	Wait until the encryption code is updated.	—
NO SIGNAL	The signal is too weak.	Check the XM Connect-and-Play digital antenna accessory connections and orient it for the best reception level.	51
LOADING	It takes longer than four seconds for audio or text data to be decoded.	Wait until the decoding process has finished.	—
OFF AIR	The XM Satellite Radio channel you selected is not currently broadcasting any signals.	Check the channel number again or select another XM Satellite Radio channel.	—
<XM> - - -	The Channel Station ID (SID) is no longer available.		
- - - / - - -	No artist name or song title is available.		
<CAT> - - -	No channels are available for the selected category.	Select another channel category by pressing CATEGORY on the front panel (or A-E/CAT. </> on the remote control) repeatedly.	56

## ■ Remote control

Problem	Cause	Remedy	See page	
<b>The remote control does not work nor function properly.</b>	Wrong distance or angle.	The remote control functions within a maximum range of 6 m (20 ft) and no more than 30 degrees off-axis from the front panel.	8	
	Direct sunlight or lighting (from an inverter type of fluorescent lamp, etc.) is striking the remote control sensor of this unit.	Reposition this unit.	—	
	The batteries are weak.	Replace all batteries.	3	
	The remote control code is not correctly set.	Set the remote control code correctly using "LIST OF REMOTE CONTROL CODES" at the end of this manual.		88
		Try setting another code for the same manufacturer using "LIST OF REMOTE CONTROL CODES" at the end of this manual.		88
	The library code of the remote control and the remote control ID of this unit do not match.	Match the remote control ID of this unit with the corresponding remote control library code.		85, 89
Even if the remote control code is correctly set, there are some models that do not respond to the remote control.				

# GLOSSARY

## Audio information

### ■ Dolby Digital

Dolby Digital is a digital surround sound system that gives you completely independent multi-channel audio. With 3 front channels (front L/R and center), and 2 surround stereo channels, Dolby Digital provides 5 full-range audio channels. With an additional channel especially for bass effects, called LFE (Low Frequency Effect), the system has a total of 5.1-channels (LFE is counted as 0.1 channel). By using 2-channel stereo for the surround speakers, more accurate moving sound effects and surround sound environment are possible than with Dolby Surround. The wide dynamic range from maximum to minimum volume reproduced by the 5 full-range channels and the precise sound orientation generated using digital sound processing provide listeners with unprecedented excitement and realism. With this unit, any sound environment from monaural up to a 5.1-channel configuration can be freely selected for your enjoyment.

### ■ Dolby Digital EX

Dolby Digital EX creates 6 full-bandwidth output channels from 5.1-channel sources. This is done using a matrix decoder that derives 3 surround channels from the 2 in the original recording. For the best results, Dolby Digital EX should be used with movie sound tracks recorded with Dolby Digital Surround EX. With this additional channel, you can experience more dynamic and realistic moving sound especially with scenes with “fly-over” and “fly-around” effects.

### ■ Dolby Pro Logic II

Dolby Pro Logic II is an improved technique used to decode vast numbers of existing Dolby Surround sources. This new technology enables a discrete 5-channel playback with 2 front left and right channels, 1 center channel, and 2 surround left and right channels instead of only 1 surround channel for conventional Pro Logic technology. There are three modes available: “Music mode” for music sources, “Movie mode” for movie sources and “Game mode” for game sources.

### ■ Dolby Pro Logic Ix

Dolby Pro Logic Ix is a new technology enabling discrete multi-channel playback from 2-channel or multi-channel sources. There are three modes available: “Music mode” for music sources, “Movie mode” for movie sources (for 2-channel sources only) and “Game mode” for game sources.

### ■ Dolby Surround

Dolby Surround uses a 4-channel analog recording system to reproduce realistic and dynamic sound effects: 2 front left and right channels (stereo), a center channel for dialog (monaural), and a surround channel for special sound effects (monaural). The surround channel reproduces sound within a narrow frequency range. Dolby Surround is widely used with nearly all video tapes and laser discs, and in many TV and cable broadcasts as well. The Dolby Pro Logic decoder built into this unit employs a digital signal processing system that automatically stabilizes the volume on each channel to enhance moving sound effects and directionality.

### ■ DTS 96/24

DTS 96/24 offers an unprecedented level of audio quality for multi-channel sound on DVD video, and is fully backward-compatible with all DTS decoders. “96” refers to a 96 kHz sampling rate compared to the typical 48 kHz sampling rate. “24” refers to 24-bit word length. DTS 96/24 offers sound quality transparent to the original 96/24 master, and 96/24 5.1-channel sound with full-quality full-motion video for music programs and motion picture soundtracks on DVD video.

### ■ DTS (Digital Theater Systems) Digital Surround

DTS digital surround was developed to replace the analog soundtracks of movies with a 6.1-channel digital sound track, and is now rapidly gaining popularity in movie theaters around the world. Digital Theater Systems Inc. has developed a home theater system so that you can enjoy the depth of sound and natural spatial representation of DTS digital surround in your home. This system produces practically distortion-free 6.1-channel sound (technically, front left and right, center, surround left and right and LFE 0.1 (subwoofer) channels for a total of 5.1 channels). This unit incorporates a DTS-ES decoder that enables 6.1-channel reproduction by adding the surround back channel to the existing 5.1-channel format.

### ■ ITU-R

ITU-R is the radio communication sector of the ITU (International Telecommunication Union). ITU-R recommends a standard speaker placement which is used in many critical listening rooms, especially for mastering purposes.

### ■ LFE 0.1 channel

This channel reproduces low-frequency signals. The frequency range of this channel is from 20 Hz to 120 Hz. This channel is counted as 0.1 because it only enforces a low-frequency range compared to the full-range reproduced by the other 5/6 channels in Dolby Digital or DTS 5.1/6.1-channel systems.

### ■ Neo:6

Neo:6 decodes the conventional 2-channel sources for 6-channel playback by the specific decoder. It enables playback with the full-range channels with higher separation just like digital discrete signal playback. There are two modes available: "Music mode" for music sources and "Cinema mode" for movie sources.

### ■ Neural Surround

Neural Surround™ represents the latest advancement in surround technology and has been adopted by XM Satellite Radio for digital radio broadcast of surround recordings and live events in surround sound. Neural Surround™ employs psychoacoustic frequency domain processing which allows delivery of a more detailed sound stage with superior channel separation and localization of audio elements. System playback is scalable from 5.1 to 7.1 multi-channel surround playback.

### ■ PCM (Linear PCM)

Linear PCM is a signal format under which an analog audio signal is digitized, recorded and transmitted without using any compression. This is used as a method of recording CDs and DVD audio. The PCM system uses a technique for sampling the size of the analog signal per very small unit of time. Standing for "Pulse Code Modulation", the analog signal is encoded as pulses and then modulated for recording.

### ■ Sampling frequency and number of quantized bits

When digitizing an analog audio signal, the number of times the signal is sampled per second is called the sampling frequency, while the degree of fineness when converting the sound level into a numeric value is called the number of quantized bits. The range of rates that can be played back is determined based on the sampling rate, while the dynamic range representing the sound level difference is determined by the number of quantized bits. In principle, the higher the sampling frequency, the wider the range of frequencies that can be played back, and the higher the number of quantized bits, the more finely the sound level can be reproduced.

## Video information

### ■ Component video signal

With the component video signal system, the video signal is separated into the Y signal for the luminance and the P<sub>B</sub> and P<sub>R</sub> signals for the chrominance. Color can be reproduced more faithfully with this system because each of these signals is independent. The component signal is also called the "color difference signal" because the luminance signal is subtracted from the color signal. A monitor with component input jacks is required in order to output component signals.

### ■ Composite video signal

With the composite video signal system, the video signal is composed of three basic elements of a video picture: color, brightness and synchronization data. A composite video jack on a video component transmits these three elements combined.

### ■ S-video signal

With the S-video signal system, the video signal normally transmitted using a pin cable is separated and transmitted as the Y signal for the luminance and the C signal for the chrominance through the S-video cable. Using the S VIDEO jack eliminates video signal transmission loss and allows recording and playback of even more beautiful images.

## ***Sound field program information***

### ■ **CINEMA DSP**

Since the Dolby Surround and DTS systems were originally designed for use in movie theaters, their effect is best felt in a theater having many speakers designed for acoustic effects. Since home conditions, such as room size, wall material, number of speakers, and so on, can differ so widely, it is inevitable that there are differences in the sound heard. Based on a wealth of actually measured data, YAMAHA CINEMA DSP uses YAMAHA original sound field technology to combine Dolby Pro Logic, Dolby Digital and DTS systems to provide the audiovisual experience of movie theater in the listening room of your own home.

### ■ **SILENT CINEMA**

YAMAHA has developed a natural, realistic sound effect DSP algorithm for headphones. Parameters for headphones have been set for each sound field so that accurate representations of all the sound field programs can be enjoyed on headphones.

### ■ **Virtual CINEMA DSP**

YAMAHA has developed a Virtual CINEMA DSP algorithm that allows you to enjoy DSP sound field surround effects even without any surround speakers by using virtual surround speakers. It is even possible to enjoy Virtual CINEMA DSP using a minimal two-speaker system that does not include a center speaker.

# SPECIFICATIONS

## AUDIO SECTION

- Minimum RMS Output Power for Front, Center, Surround, Surround back  
20 Hz to 20 kHz, 0.06% THD, 8  $\Omega$  ..... 90 W
- Maximum Power (EIAJ)  
[Asia, China, Korea and General models]  
1 kHz, 10% THD, 8  $\Omega$  ..... 130 W
- Dynamic Power (IHF)  
8/6/4/2  $\Omega$  ..... 120/155/190/235 W
- Maximum Output Power [Europe model]  
1 kHz, 0.7% THD, 4  $\Omega$  ..... 140 W
- IEC Output Power [Europe and Asia models]  
1 kHz, 0.06% THD, 8  $\Omega$  ..... 100 W
- Damping Factor (IHF)  
20 Hz to 20 kHz, 8  $\Omega$  ..... 120 or more
- Frequency Response  
CD terminal to Front L/R ..... 10 Hz to 100 kHz, -3 dB
- Total Harmonic Distortion  
CD, etc. to Front L/R (20 Hz to 20 kHz, 45 W, 8  $\Omega$ )  
..... 0.06% or less
- Signal to Noise Ratio (IHF-A Network)  
CD (250 mV) to Front L/R, Effect Off ..... 100 dB or more
- Residual Noise (IHF-A Network)  
Front L/R ..... 150  $\mu$ V or less
- Channel Separation (1 kHz/10 kHz)  
CD (5.1 k $\Omega$  terminated) to Front L/R ..... 60 dB/45 dB or more
- Tone Control (Front L/R)  
BASS Boost/Cut .....  $\pm$ 10 dB/60 Hz  
TREBLE Boost/Cut .....  $\pm$ 10 dB/20 kHz
- Phones Output ..... 150 mV/100  $\Omega$
- Input Sensitivity/Input Impedance  
CD, etc. .... 200 mV/47 k $\Omega$   
MULTI CH INPUT ..... 200 mV/47 k $\Omega$
- Output Level/Output Impedance  
REC OUT ..... 200 mV/1.2 k $\Omega$   
SUBWOOFER OUTPUT ..... 4 V/1.2 k $\Omega$

## VIDEO SECTION

- Video Signal Type ..... PAL/NTSC
- Signal to Noise Ratio ..... 50 dB or more
- Frequency Response (MONITOR OUT)  
Component ..... 5 Hz to 60 MHz, -3 dB

## FM SECTION

- Tuning Range  
[U.S.A. and Canada models] ..... 87.5 to 107.9 MHz  
[Asia and General models] ..... 87.5/87.50 to 108.0/108.00 MHz  
[Other models] ..... 87.50 to 108.00 MHz
- Usable Sensitivity (IHF) ..... 1.0  $\mu$ V (11.2 dBf)
- Signal to Noise Ratio (IHF)  
Mono/Stereo ..... 76 dB/70 dB
- Harmonic Distortion (1 kHz)  
Mono/Stereo ..... 0.2%/0.3%
- Stereo Separation (1 kHz) ..... 42 dB
- Frequency Response ..... 20 Hz to 15 kHz, +0.5, -2 dB

## AM SECTION

- Tuning Range  
[U.S.A. and Canada models] ..... 530 to 1710 kHz  
[Asia and General models] ..... 530/531 to 1710/1611 kHz  
[Other models] ..... 531 to 1611 kHz
- Usable Sensitivity ..... 300  $\mu$ V/m

## GENERAL

- Power Supply  
[U.S.A. and Canada models] ..... AC 120 V, 60 Hz  
[Australia model] ..... AC 240 V, 50 Hz  
[China model] ..... AC 220 V, 50 Hz  
[Korea model] ..... AC 220 V, 60 Hz  
[U.K. and Europe models] ..... AC 230 V, 50 Hz  
[General model] ..... AC 110/120/220/230-240 V, 50/60 Hz  
[Asia model] ..... AC 220/230-240 V, 50/60 Hz
- Power Consumption  
[U.S.A. and Canada models] ..... 350 W/440 VA  
[Other models] ..... 360 W
- Standby Power Consumption ..... 0.1 W or less
- AC Outlets  
[U.K. and Australia models] ..... 1 (Total 100 W maximum)  
[U.S.A., Canada  
and China models] ..... 2 (Total 100 W maximum)  
[Europe, Asia  
and General models] ..... 2 (Total 50 W maximum)
- Dimensions (W x H x D) ..... 435 x 161 x 391 mm  
(17.1 x 6.3 x 15.4 in)
- Weight ..... 10.5 kg (23.1 lbs)



# LIST OF REMOTE CONTROL CODES

## CABLE TV RECEIVER

ABC 10003, 10008,  
10014, 10017,  
10033  
AMERICAST 10899  
BELL & HOWELL  
10014  
BELL SOUTH 10899  
CLEARMASTER  
10883  
CLEARMAX 10883  
COOLMAX 10883  
DIGEO 11187  
DIGI 10637  
DIRECTOR 10476  
DUMONT 10637  
GENERAL INSTRUMENT  
10003, 10276,  
10476, 10810  
GOLDSTAR  
10144  
HAMLIN 10009, 10273  
I3 MICRO 11602  
JERROLD 10003, 10012,  
10014, 10276,  
10476, 10810  
MACOM 10033  
MEMOREX 10000  
MOTOROLA 10014, 10276,  
10476, 10810,  
11187, 11254,  
11376  
MULTITECH 10883  
MYRIO 11602  
PACE 10008, 10237,  
11877  
PANASONIC 10000, 10107  
PANTHER 10637  
PARAGON 10000  
PHILIPS 10317, 11305  
PIONEER 10144, 10533,  
10877, 11877  
PULSAR 10000  
QUASAR 10000  
RADIOSHACK  
10883  
RCA 11256  
REGAL 10273, 10279  
RUNCO 10000  
SAMSUNG 10144  
SCIENTIFIC ATLANTA  
10008, 10017,  
10477, 10877,  
11877  
SEJIN 11602  
SONY 11006  
STARCOM 10003  
SUPERCABLE  
10276  
SUPERMAX 10883  
THOMSON 11256  
TOCOM 10012  
TORX 10003  
TOSHIBA 10000  
TRISTAR 10883  
V2 10883  
VIEWMASTER 10883  
VISION 10883  
VORTEX VIEW 10883  
ZENITH 10000, 10525,  
10899

## CABLE/PVR COMBINATION

AMERICAST 10899  
DIGEO 11187  
GENERAL INSTRUMENT  
10476, 10810  
JERROLD 10476, 10810  
MOTOROLA 10476, 10810,  
11187, 11376  
PACE 10237, 11877  
PIONEER 10877, 11877  
RCA 11256  
SCIENTIFIC ATLANTA  
10877, 11877  
SONY 11006  
SUPERCABLE  
10276  
THOMSON 11256  
ZENITH 10899

## DBS/PVR COMBINATION

DIRECTV 10099, 10392,  
10639, 11076,  
11142, 11377,  
11392, 11442,  
11443, 11444,  
11640  
DISH NETWORK SYSTEM  
10775, 11505  
DISHPRO 10775, 11505  
ECHOSTAR 10775, 11170,  
11505  
EXPRESSVU 10775  
HUGHES NETWORK SYSTEMS  
11142, 11442,  
11443, 11444  
JVC 11170  
MOTOROLA 10869  
PHILIPS 11142, 11442  
PROSCAN 10392  
RCA 11392  
SAMSUNG 11442  
SONY 10639, 11640  
STAR CHOICE  
10869

## SATELLITE RECEIVER

ALPHASTAR 10772  
CHAPARRAL 10053, 10216  
CROSSDIGITAL  
11109  
DIRECTV 10099, 10247,  
10392, 10566,  
10639, 10724,  
10749, 10819,  
11076, 11108,  
11109, 11142,  
11377, 11392,  
11414, 11442,  
11443, 11444,  
11609, 11639,  
11640, 11749,  
11856

DISH NETWORK SYSTEM  
10775, 11005,  
11170, 11505,  
11775  
DISHPRO 10775, 11005,  
11505, 11775  
ECHOSTAR 10269, 10280,  
10775, 11005,  
11170, 11505,  
11775  
EXPRESSVU 10775, 11775  
GE 10392, 10566  
GENERAL INSTRUMENT  
10869  
GOI 10775, 11775  
GOODMANS 11246  
HISENSE 11535  
HITACHI 10819, 11250  
HOMECABLE 10238  
HTS 10775, 11775  
HUGHES 10749, 11442,  
11749

## HUGHES NETWORK SYSTEMS

10749, 11142,  
11442, 11443,  
11444, 11749

ILO 11535  
IQ 10210  
IQ PRISM 10210  
JERROLD 10869  
JVC 10775, 11170,  
11775  
LEGEND 10269  
LG 11226, 11414  
MAGNAVOX 10722, 10724  
MEMOREX 10269, 10724  
MITSUBISHI 10749  
MOTOROLA 10856, 10869  
NEC 11270  
NEXT LEVEL 10869  
PANASONIC 10247, 10701  
PAYSAT 10724  
PHILIPS 10099, 10722,  
10724, 10749,  
10819, 11076,  
11142, 11442,  
11749  
PIONEER 11442  
PROSCAN 10392, 10566  
PROTON 11535  
RADIOSHACK

10869  
RCA 10143, 10392,  
10566, 10855,  
11392  
REALISTIC 10052  
SAMSUNG 11108, 11109,  
11142, 11276,  
11377, 11442,  
11609  
SANYO 11219  
SONY 10639, 11639,  
11640  
STAR CHOICE 10869  
STS 10210  
TIVO 11142, 11442,  
11443, 11444  
TOSHIBA 10082, 10749,  
10790, 10819,  
11285, 11749  
ULTIMATE TV 11392, 11640

UNIDEN 10052, 10074,  
10238, 10722,  
10724  
US DIGITAL 11535  
USD TV 11535  
VOOM 10869  
ZENITH 11856

## HDTV DECODER

ACCURIAN 11653  
EPSON 11563, 11650  
LG 11415  
MACRO IMAGE TECHNOLOGY  
11383  
MOTOROLA 11363  
MYHD 11383  
PANASONIC 11120  
PIONEER 11010  
PRINCETON 10113, 10295  
SAMSUNG 11190, 11490  
SASEM 11641  
SENSORY SCIENCE  
11126  
SHARP 11010  
SYLVANIA 11563  
TELEMANN 11604  
VIEWSONIC 11329  
VIZIO 11126

## OTHER VIDEO ACCESSORIES

ABS 11272  
ACCURIAN 11653  
ALIENWARE 11272  
CYBERPOWER  
11272  
D-LINK 11554  
ECS 11553  
EPSON 11563, 11650  
GATEWAY 11272  
HEWLETT PACKARD  
11267, 11272  
HOWARD COMPUTERS  
11272  
HP 11272  
HUSH 11272  
IBUYPOWER 11272  
INTERVIDEO 11393  
KEYSPAN 11344  
KWORD 11403  
LEADTEK 11614  
LG 11415  
LINKSYS 11272, 11365  
MACRO IMAGE TECHNOLOGY  
11383  
MEDIA CENTER PC  
11272  
MICROSOFT 11272  
MIND 11272  
MOTOROLA 11363  
MYHD 11383  
NIVEUS MEDIA  
11272  
NORTHGATE 11272  
PANASONIC 11120  
PINNACLE SYSTEMS  
11268  
PIONEER 11010  
PRINCETON 10113, 10295  
RICA VISION 11272

ROKU	11486	CURTIS MATHES	JCB	20000	PENNEY	20030, 20047,
SAMSUNG	11190, 11490		JENSEN	20761, 20815,		20051, 20060,
SASEM	11641			20817, 21933		20156, 20178,
SENSORY SCIENCE			JVC	20053, 20069,		21347, 21919,
	11126			20160, 20169,		21926
SHARP	11010		KEC	20731, 21253	PHILCO	20030, 20054
SMC	11456			20180	PHILIPS	20054, 20690,
SONY	11272, 11324,		KENWOOD	20030, 20859		21154, 21454
	11364	CXC	KLH	20765, 20767,	PILOT	20030
STACK 9	11272	DAEWOO		21962	PIONEER	20038, 20166,
STREAMZAP	11309		KTV	20030, 20180		20679, 20866
SYLVANIA	11563		LG	20178, 20442,	POLAROID	20765, 20865
SYSTEMAX	11272			20700, 20856,	PORTLAND	20092
TAGAR SYSTEMS		DELL		21178, 21265	PRIMA	20761, 20783,
	11272		LLOYD'S	21904		20815, 20817,
TELEMANN	11604	DENON	LOEWE	20136		21933
TOSHIBA	11272	DUMONT	LXI	20047, 20054,	PRINCETON	20700, 20717
TOUCH	11272	DURABRAND		20154, 20156,	PRISM	20051
VIEWSONIC	11272, 11329			20178	PROSCAN	20047, 20466,
VIZIO	11126		MAGNASONIC			21347, 21447,
VOODOO	11272	DWIN		21928		21922
ZT GROUP	11272		MAGNAVOX	20030, 20054,	PROTON	20178, 20466
				20706, 20802,	PULSAR	20017
				21254, 21454,	QUASAR	20051, 20250,
				21904, 21931,		20650, 21919
				21944	RADIOSHACK	
<b>TV</b>		ELECTROBAND				
ADMIRAL	20093, 20463					
ADVENT	20761, 20783,	ELECTROGRAPH	MARANTZ	20030, 20054,		20030, 20047,
	20815, 20817,			20704, 20854,		20154, 20178,
	20842, 21933	EMERSON		20855, 21154,		20180, 21904
				21454	RCA	20038, 20047,
AIKO	20092		MATSUSHITA	20250, 20650		20090, 20679,
AIWA	20701		MAXENT	21755		21047, 21147,
AKAI	20030, 20060,	ENVISION	MEGAPOWER			21247, 21347,
	20672, 20702,			20700		21447, 21547,
	20812, 21903	EPSON		20145, 20178		21917, 21919,
ALBATRON	20700, 20843	ESA	MEGATRON	20150, 20154,		21922, 21948,
AMERICA ACTION		FISHER	MEMOREX	20178, 20463,		21953, 21958
	20180	FUJITSU		21926	REALISTIC	20030, 20154,
AMPRO	20751		MGA	20030, 20150,		20178, 20180
ANAM	20180	FUNAI		20155, 20178	RUNCO	20017, 20030,
AOC	20030		MIDLAND	20017, 20047,		20497, 20603
APEX DIGITAL		FUTURETECH		20051	SAMPO	20030, 21755
	20156, 20748,				SAMSUNG	20030, 20060,
	20765, 20767,	GATEWAY	MITSUBISHI	20014, 20093,		20178, 20587,
	20879, 21943	GE		20150, 20155,		20702, 20766,
AUDIOVOX	20092, 20180,			20178, 20331,		20812, 20814,
	20451, 20623,			20358, 20836,		21060, 21903,
	20802, 20875,			20868, 21250,		21959
	21937, 21951,			21917	SANSUI	20463, 21904,
	21952	GIBRALTER	MONIVISION	20700, 20843		21929, 21935
AVENTURA	20171	GO VIDEO	MOTOROLA	20093	SANYO	20088, 20154,
AXION	21937	GOLDSTAR	MTC	20030, 20060		20484, 20799,
BELL & HOWELL			MULTITECH	20180		20893
	20154		NAD	20156, 20178,	SCOTCH	20178
BENQ	21032	GOODMANS		20866	SCOTT	20178, 20180,
BOXLIGHT	20893	GRUNDIG	NEC	20030, 20497,		20236
BRADFORD	20180	GRUNPY		20882, 21704	SEARS	20047, 20054,
BROKSONIC	20180, 20236,	HAIER	NETTV	21755		20154, 20156,
	20463, 21929,	HALLMARK	NIKKO	20030, 20092,		20171, 20178,
	21935, 21938	HARLEY DAVIDSON		20178		21904, 21926
CANDLE	20030		NORCENT	20748, 20824	SHARP	20093, 20153,
CARNIVALE	20030	HARMAN/KARDON	NTC	20092		20491, 20688,
CARVER	20054		ONWA	20180		20689, 20818,
CELEBRITY	20000	HARVARD	OPTIMUS	20154, 20166,		20851, 21917
CELERA	20765	HAVERMY		20250, 20650	SHENG CHIA	20093
CHANGHONG		HELIOS	OPTOMA		SOLE	20011,
	20765	HELLO KITTY		20887	SONY	20080, 20111,
			OPTONICA	20093		20810, 20834,
CITIZEN	20030, 20060,	HISENSE	ORION	20236, 20463,		20867, 21100,
	20092, 21928	HITACHI		21463, 21929	SOUNDESIGN	21904, 21925
CLARION	20180		PANASONIC	20051, 20226,		
COMMERCIAL SOLUTIONS				20250, 20650,		
	20047, 21447			20863, 21410,		
CONTEC	20180	HYUNDAI		21919, 21941,		
CRAIG	20180			21946, 21947		
CROSLEY	20054	INFINITY			SOVA	20178, 20180
CROWN	20180	INTEQ				21952
		JBL				

SQUAREVIEW		HOWARD COMPUTERS		DURABRAND		MTC	30240
	20171		31972		30038, 30039	MULTITECH	30072
SSS	20180	HP	31972	ELECTROHOME		NEC	30038, 30041,
STARLITE	20180	HUGHES NETWORK SYSTEMS			30037, 30043		30067, 30104
STUDIO EXPERIENCE			30739	ELECTROPHONIC		NIKKO	30037
	20843	HUMAX	30739		30037	NIVEUS MEDIA	
SUPERSCAN	20093, 20864	HUSH	31972	EMEREX	30032		31972
SUPREME	20000	IBUYPOWER	31972	EMERSON	30002, 30037,	NOBLEX	30240
SVA	20587, 20748,	LG	32010		30043, 30121,	NORTHGATE	31972
	20865, 20870,	LINKSYS	31972		30184, 30209,	OLYMPUS	30035
	20871, 20872	MEDIA CENTER PC			30278, 30479,	OPTIMUS	30037, 30048,
SYLVANIA	20030, 20054,		31972		30593, 31593		30104, 30162,
	20171, 21931,	MICROSOFT	31972	FISHER	30047, 30104		30432, 30593,
	21944	MIND	31972	FUJI	30033, 30035		31048, 31062,
SYMPHONIC	20171, 20180,	NIVEUS MEDIA		FUNAI	30593, 31593		31162, 31262
	21904		31972	GATEWAY	31972	ORION	30002, 30184,
TANDY	20093	NORTHGATE	31972	GE	30035, 30060,		30209, 30479
TATUNG	21756	PANASONIC	30616, 31807,		30240	PANASONIC	30035, 30162,
TECHNICS	20051, 20250		31808, 31809	GO VIDEO	30240, 30432		30616, 31062,
TECHVIEW	20847	PHILIPS	30618, 30739	GOLDSTAR	30037, 30038		31162, 31244,
TECHWOOD	20051	RCA	30880	HARMAN/KARDON			31262, 31562,
TEKNIKA	20054, 20060,	REPLAYTV	30614, 30616		30038, 30081		31807, 31808,
	20092, 20150,	SONIC BLUE	30614, 30616	HARWOOD	30072		31809
	20180	SONY	30636, 31972	HEWLETT PACKARD		PENNEY	30035, 30037,
TELEFUNKEN		STACK 9	31972		31972		30038, 30042,
	20702	SYSTEMAX	31972	HI-Q	30047		30240
THOMAS	21904	TAGAR SYSTEMS		HITACHI	30041, 30042	PENTAX	30042
TMK	20178		31972	HOWARD COMPUTERS		PHILCO	30035
TNCI	20017	TIVO	30618, 30636,		31972	PHILIPS	30035, 30081,
TOSHIBA	20060, 20154,		30739	HP	31972		30618, 30739,
	20156, 20650,	TOSHIBA	31008, 31972	HUGHES NETWORK SYSTEMS			31081, 31181
	20832, 20845,	TOUCH	31972		30042, 30739	PILOT	30037
	21156, 21256,	VIEWSONIC	31972	HUMAX	30739, 31988	PIONEER	30067
	21265, 21356,	VOODOO	31972	HUSH	31972	POLK AUDIO	30081
	21656, 21704,	ZT GROUP	31972	IBUYPOWER	31972	PROFITRONIC	
	21918, 21935,			JENSEN	30041		30240
	21936, 21945			JVC	30041, 30067,	PROSCAN	30060
TVS	20463				31162	PROTEC	30072
VECTOR RESEARCH		<b>VCR</b>		KEC	30037, 30278	PULSAR	30039
	20030	ABS	31972	KENWOOD	30038, 30041,	QUASAR	30035, 30162,
VICTOR	20053	ADMIRAL	30048, 30209,		30067		31162
VIDIKRON	20054		30479	KLH	30072	RADIOSHACK	
VIDTECH	20178	AIKO	30278	KODAK	30035, 30037		31037
VIEWSONIC	20857, 20864,	AIWA	30037	LG	31037, 32010	RADIX	30037
	20885, 21755	AKAI	30041	LINKSYS	31972	RANDEX	30037
VIZIO	20864, 20885,	ALIENWARE	31972	LOGIK	30072	RCA	30042, 30060,
	21756	AMERICA ACTION		LXI	30037		30149, 30240,
WARDS	20030, 20054,		30278	MAGNASONIC			30880
	20080, 20111,	AMERICAN HIGH			30593	REALISTIC	30035, 30037,
	20178, 20866,		30035	MAGNAVOX	30035, 30039,		30047, 30048,
	21156	ASHA	30240		30081, 30149,		30104
WAYCON	20156	AUDIOVOX	30037, 30278		30563, 30593	REPLAYTV	30614, 30616
WESTINGHOUSE		BEAUMARK	30240	MAGNIN	30240	RICAVISION	31972
	20451, 20889	BELL & HOWELL		MARANTZ	30035, 30081	RUNCO	30039
WHITE WESTINGHOUSE			30104	MARTA	30037	SAMSUNG	30045, 30240,
	20463, 20623	BROKSONIC	30002, 30121,	MATSUSHITA	30035, 30162,		30739
YAMAHA	20030, 20650,		30184, 30209,		31162	SANKY	30039, 30048
	20769, 20833,		30479	MEDIA CENTER PC		SANSUI	30041, 30067,
	20839, 21405,	CALIX	30037		31972		30209, 30479
	21406, 21407	CANON	30035	MEI	30035	SANYO	30047, 30104,
ZENITH	20017, 20092,	CARVER	30081	MEMOREX	30035, 30037,		30240
	20178, 20463,	CCE	30072, 30278		30039, 30047,	SCOTT	30043, 30045,
	21145, 21904,	CITIZEN	30037, 30278		30048, 30104,		30121, 30184
	21929	COLT	30072		30162, 30209,	SEARS	30035, 30037,
		CRAIG	30037, 30047,		30240, 30479,		30042, 30047,
			30072, 30240		31037, 31162,		30104
		CURTIS MATHES			31262	SHARP	30048, 30848
			30035, 30041,	MGA	30043, 30240	SHINTOM	30072
			30060, 30162	MGN TECHNOLOGY		SHOGUN	30240
		CYBERNEX	30240		30240	SINGER	30072
		CYBERPOWER		MICROSOFT	31972	SONIC BLUE	30614, 30616
			31972	MIND	31972	SONY	30032, 30033,
		DAEWOO	30045, 30278	MINOLTA	30042		30035, 30636,
		DELL	31972	MITSUBISHI	30043, 30067		31032, 31972
		DENON	30042	MOTOROLA	30035, 30048	STACK 9	31972
		DIRECTV	30739				
<b>PVR</b>							
ABS	31972						
ALIENWARE	31972						
CYBERPOWER	31972						
DELL	31972						
DIRECTV	30739						
GATEWAY	31972						
HEWLETT PACKARD							
	31972						

STS	30042	CALIFORNIA AUDIO LABS		MALATA	40782, 41159	TEAC	40790, 40809
SYLVANIA	30035, 30043, 30081, 30593, 31593	40490		MARANTZ	40539	TECHNICS	40490, 40703
SYMPHONIC	30593, 31593	CINEVISION	40833, 40869, 40876	MCINTOSH	41273, 41533	TECHNOSONIC	
SYSTEMAX	31972	CITIZEN	41277	MEMOREX	40695, 41270	40730	
TAGAR SYSTEMS		COBY	40778, 40852, 41107, 41177, 41351	MICROSOFT	40522	TECHWOOD	40692
TATUNG	30041	CURTIS MATHES	41087	MINTEK	40717, 40839	THETA DIGITAL	
TEAC	30041	CYBERHOME		MITSUBISHI	40521, 41521	40571	
TECHNICS	30035, 30162		40816, 40874, 41023, 41024, 41117	MOMITSU	41082	TOSHIBA	40503, 40695, 41154
TEKNIKA	30035, 30037	DAEWOO	40705, 40833, 40869, 41169, 41172, 41234, 41242	MYRYAD	40894	TREDEX	40799, 40800, 40803, 40804
TIVO	30618, 30636, 30739, 31503	DAYTEK	40872	NAD	40591, 40692, 40741	URBAN CONCEPTS	40503
TMK	30240	DENON	40490	NAKAMICHI	41222	40839	
TOSHIBA	30043, 30045, 30209, 31008, 31972, 31988	DESAY	41407	NEC	40785	US LOGIC	40790
TOTEVISION	30037, 30240	DISNEY	40675, 41270	NESA	40717	VENTURER	40790
TOUCH	31972	DUAL	41068, 41085	NEXT BASE	40826	VIZIO	41064, 41226
UNITECH	30240	DURABRAND		NORCENT	40872, 41003, 41107, 41265	XBOX	40522
VECTOR	30045		41127	ONKYO	40503, 40627, 40792, 41627	YAMAHA	40490, 40539, 40545, 41543
VECTOR RESEARCH	30038	EMERSON	40591, 40675, 40821, 41268	ORITRON	40651	YAMAKAWA	40872
VIDEO CONCEPTS		ENTERPRISE	40591	PANASONIC	40490, 40503, 40632, 40703, 41762	ZENITH	40503, 40591, 40741, 40869
30045		FUNAI	40675, 41268	PHILIPS	40503, 40539, 40675, 40854, 41260, 41267, 41354	ZOECE	41265
VIDEOMAGIC	30037	GATEWAY	41073, 41077	PIANODISC	41024		
VIDEOSONIC	30240	GE	40522, 40717, 40815	PIONEER	40525, 40571, 40632, 41571	<b>LD PLAYER</b>	
VIEWSONIC	31972	GO VIDEO	40715, 40741, 40744, 40783, 40833, 40869, 41044, 41075, 41099	POLAROID	41020, 41061	AIWA	40203
VOODOO	31972	GO VISION	41071, 41072	POLK AUDIO	40539	CARVER	40064, 40194, 40323
WARDS	30035, 30042, 30047, 30048, 30060, 30072, 30081, 30149, 30240	GOLDSTAR	40741	PRIMA	41016	DENON	40059, 40172
WHITE WESTINGHOUSE		GPX	40699, 40769	PRINCETON	40674	DISCO VISION	
30072, 30209		GRADIENTE	40490	PROCEED	40672	40023	
XR-1000	30035, 30072	GREENHILL	40717	PROSCAN	40522	FUNAI	40203
YAMAHA	30038	GRUNDIG	40539	PROVISION	40778	HARMAN/KARDON	40194
ZENITH	30033, 30039, 30209, 30479, 31139	HARMAN/KARDON		QWESTAR	40651	40194	
ZT GROUP	31972	40582, 40702		RCA	40522, 40571, 40717, 40790, 40822, 41022, 41132, 41193	HITACHI	40023
		HITACHI	40573, 40664, 41247	RIO	40869	MAGNAVOX	40194, 40217
		HITEKER	40672	RJTECH	41360	MARANTZ	40064, 40194
		INITIAL	40717	ROTEL	40623, 41178	MITSUBISHI	40059
		INTEGRA	40571, 40627	ROWA	40823	NAD	40059
		JATON	41078	SAMPO	40698, 40752	OPTIMUS	40059
		JBL	40702	SAMSUNG	40490, 40573, 40744, 40820, 40899, 41044, 41075	PANASONIC	40204
		JENSEN	41016	SANSUI	40695	PHILIPS	40064, 40194
		JSI	41423	SANYO	40695, 40873	PIONEER	40023, 40059
		JVC	40558, 40623, 40867	SHARP	40630, 40675, 40752, 41256	POLK AUDIO	
		JWIN	41049, 41051	SHARPER IMAGE		40194	
		KAWASAKI	40790	41117		QUASAR	40204
		KENWOOD	40490, 40534, 40682, 40737	SHERWOOD	40633, 41043, 41077	REALISTIC	40203
		KLH	40717, 40790, 41020, 41149, 41261	SHINSONIC	40533, 40839	SAMSUNG	40323
		KONKA	40711	SIGMA DESIGNS		SEGA	40023
		KOSS	40651, 41423	40674		SONY	40193, 40201
		LANDEL	40826	SONIC BLUE	40869, 41099	TECHNICS	40204
		LASONIC	40798, 41173	SONY	40533, 40864, 41017, 41033, 41533	THETA DIGITAL	
		LECSON	41533	SOVA	41122	40194	
		LENOXX	41127	SUNGALE	41074	YAMAHA	40217
		LG	40591, 40741, 40801, 40869	SUPERSCAN	40821	<b>DVD RECORDER</b>	
		LOEWE	40511	SVA	40860, 41105	APEX DIGITAL	
		MAGNAVOX	40503, 40539, 40675, 40821	SYLVANIA	40675, 40821, 41268	51056	
				SYMPHONIC	40675, 41268	ASPIRE DIGITAL	
				TAG MCLAREN	40894	51168	
						COBY	51086
						CYBERHOME	
						51129	
						FUNAI	50675, 51334
						GATEWAY	51073, 51158
						GO VIDEO	50741, 51158, 51304, 51730
						ILO	51348
						JVC	51164, 51275
						LG	50741
						LITEON	51158, 51416, 51440
						MAGNAVOX	50646

PANASONIC 50490, 51010,  
51011  
PHILIPS 50646  
PIONEER 50631, 51475,  
51476  
POLAROID 51086  
RCA 50522  
SAMSUNG 50490  
SENSORY SCIENCE|  
51158  
SHARP 50675, 51550,  
51556, 50630  
SONY 51033, 51069,  
51070, 51431  
SYLVANIA 50675  
TOSHIBA 51510  
VICTOR 51275  
YAMAHA 51544  
ZENITH 50741

---

## CD PLAYER

AIWA 60157  
ARCAM 60157  
BURMESTER 60420  
CALIFORNIA AUDIO LABS  
60029, 60303  
CARVER 60157, 60179  
DENON 60003, 60034  
DKK 60000  
DMX ELECTRONICS  
60157  
FISHER 60179  
GARRARD 60393, 60420  
GENEXXA 60032  
HARMAN/KARDON  
60157  
HITACHI 60032  
INTEGRA 60101  
JVC 60072  
KENWOOD 60028, 60190,  
60626  
KLH 61318, 61372,  
61711  
KRELL 60157  
LINN 60157  
MAGNAVOX 60038, 60157  
MARANTZ 60029, 60038,  
60157, 60180,  
60435, 60626  
MCINTOSH 60256, 60290,  
60660  
MCS 60029  
MIRO 60000  
MISSION 60157  
MTC 60420  
NSM 60157  
ONKYO 60101, 61327  
OPTIMUS 60000, 60032,  
60087, 60179,  
60420, 60468  
PANASONIC 60029, 60303,  
60388, 60752  
PARASOUND 60420

PHILIPS 60157, 60274,  
60626  
PIONEER 60032, 60468,  
61062  
POLK AUDIO 60157  
PROCEED 60420  
PROTON 60157  
QED 60157  
QUAD 60157  
QUASAR 60029  
RCA 60032, 60053,  
60179, 60420,  
60468, 61062  
REALISTIC 60179, 60180,  
60420  
ROTEL 60157, 60420  
SAE 60157  
SANSUI 60157  
SANYO 60087, 60179  
SHARP 60180  
SHERWOOD 60180  
SONIC FRONTIERS  
60157  
SONY 60000, 60490  
SUGDEN 60157  
TAG MCLAREN  
60157  
TASCAM 60420  
TEAC 60180, 60378,  
60393, 60420  
TECHNICS 60029, 60303  
VICTOR 60072  
WARDS 60053, 60157  
YAMAHA 60036, 60490,  
61907

---

## CD RECORDER

HARMAN/KARDON  
71202  
JVC 71294  
KENWOOD 70626  
KLH 71373  
LG 71208  
MARANTZ 70626  
PHILIPS 70626  
PIONEER 71062, 71087  
RCA 70053, 70420  
SONY 70000, 70100,  
71364  
TDK 71208  
TEAC 70420  
YAMAHA 70888, 71292

---

## MD RECORDER

DENON 70873  
KENWOOD 70681, 70826  
ONKYO 70868  
OPTIMUS 71063  
PIONEER 71063  
SHARP 70861  
SHERWOOD 71067  
SONY 70490  
YAMAHA 70490, 70888,  
71909

---

## TAPE DECK

AIWA 70029, 70197  
CARVER 70029  
DENON 70076  
HARMAN/KARDON  
70029, 70182  
JVC 70244, 70273  
KENWOOD 70070  
MAGNAVOX 70029  
MARANTZ 70029  
ONKYO 70135, 70282  
OPTIMUS 70027, 70220  
PANASONIC 70229  
PHILIPS 70029  
PIONEER 70027, 70099,  
70220  
POLK AUDIO  
70029  
RCA 70027, 70220  
SANSUI 70029  
SONY 70170, 70243,  
70291  
TECHNICS 70229  
VICTOR 70273  
WARDS 70027  
YAMAHA 70094, 70097,  
70524

---

## TUNER

ADC 80531  
ADCOM 80616, 81616,  
81617  
AIWA 80121, 80158,  
80189, 81405  
AMC 81077  
AMPLIFIER TECHNOLOGIES  
81584  
ANAM 81074, 81609  
ARCAM 81189  
ATLANTIC TECHNOLOGY  
81487  
AUDIOTRONIC  
81189  
AUDIOVOX 81627  
B & K 80701, 80820,  
80840  
BEL CANTO DESIGN  
81584  
BK 80702  
BOSE 81933  
BOSTON ACOUSTICS  
81918  
BRIX 81602  
CAPETRONIC 80531  
CARVER 80008, 80121,  
80189, 80360,  
81189  
CLASSE 81916  
DELPHI 81414  
DENON 80121, 81360  
EMERSON 80424  
FISHER 80219, 80360  
FOSGATE 81487

GARRARD 80424  
GATEWAY 81567  
HARMAN/KARDON  
80110, 80189,  
80891, 81304  
INTEGRA 80135, 81320  
JBL 80110  
JVC 80074, 81058,  
81811  
KENWOOD 80027, 80077,  
81313, 81569,  
81570  
KLH 81428  
KOSS 80424  
LEXICON 81076  
LINN 80189  
MAGNAVOX 80189, 80531,  
81189, 81269  
MARANTZ 80039, 80189,  
80200, 81189,  
81269  
MCS 80039, 80346  
MICROMEGA 81189  
MITSUBISHI 81393  
MYRYAD 81189, 81918  
NAD 80320  
NAKAMICHI 80347, 81313,  
81555, 81919  
NIRO 81908  
ONKYO 80135, 81320  
OPTIMUS 80177, 80219,  
80531, 80670,  
81023, 81074  
OUTLAW 81487  
OUTLAW AUDIO 81487  
PANASONIC 80039, 80309,  
81308, 81518  
PHILIPS 80189, 81189,  
81269  
PIONEER 80014, 80150,  
80531, 80630,  
81023  
POLK AUDIO 80189, 81414  
QUASAR 80039  
RCA 80054, 80346,  
80360, 80531,  
81023, 81074,  
81154, 81609  
REALISTIC 80163  
SAMSUNG 81304  
SANSUI 80189, 80346,  
81189  
SANYO 80219  
SCOTT 80163, 80322  
SHERWOOD 81077, 81423,  
81567, 81918  
SIRIUS 81602, 81627,  
81811  
SONY 80158, 81058,  
81406, 81759  
SOUNDESIGN  
80670  
STEREOPHONICS  
81023  
SUNFIRE 81313  
TEAC 80163, 81074

TECHNICS	80039, 80309, 81308, 81518
THORENS	81189
TOSHIBA	80135
VICTOR	80074
WARDS	80014, 80054, 80158, 80189
XM	81406, 81414
YAMAHA	80176, 81176, 81276, 81331, 81375, 81908,
(TUNER ID1)	81916
(TUNER ID2)	81917
(XM ID1)	81918
(XM ID 2)	81919



© 2006 YAMAHA CORPORATION All rights reserved.

**YAMAHA ELECTRONICS CORPORATION, USA** 6660 ORANGETHORPE AVE., BUENA PARK, CALIF. 90620, U.S.A.  
**YAMAHA CANADA MUSIC LTD.** 135 MILNER AVE., SCARBOROUGH, ONTARIO M1S 3R1, CANADA  
**YAMAHA ELECTRONIK EUROPA G.m.b.H.** SIEMENSSTR. 22-34, 25462 RELINGEN BEI HAMBURG, GERMANY  
**YAMAHA ELECTRONIQUE FRANCE S.A.** RUE AMBROISE CROIZAT BP70 CROISSY-BEAUBOURG 77312 MARNE-LA-VALLEE CEDEX02, FRANCE  
**YAMAHA ELECTRONICS (UK) LTD.** YAMAHA HOUSE, 200 RICKMANSWORTH ROAD WATFORD, HERTS WD18 7GQ, ENGLAND  
**YAMAHA SCANDINAVIA A.B.** J A WETTERGRENS GATA 1, BOX 30053, 400 43 VÄSTRA FRÖLUNDA, SWEDEN  
**YAMAHA MUSIC AUSTRALIA PTY, LTD.** 17-33 MARKET ST., SOUTH MELBOURNE, 3205 VIC., AUSTRALIA

**YAMAHA CORPORATION**  
Printed in Malaysia ◀ WG73630



# NS-P430/ NS-P436

(NS-P430/NS-P436: NX-430P + NX-C430 + YST-SW015)



*HOME CINEMA 5.1CH SPEAKER PACKAGE/  
HOME CINEMA 6.1CH SPEAKER PACKAGE*



**OWNER'S MANUAL**



# IMPORTANT SAFETY INSTRUCTIONS

	<b>CAUTION</b> RISK OF ELECTRIC SHOCK DO NOT OPEN	
<b>CAUTION: TO REDUCE THE RISK OF ELECTRIC SHOCK, DO NOT REMOVE COVER (OR BACK). NO USER-SERVICEABLE PARTS INSIDE. REFER SERVICING TO QUALIFIED SERVICE PERSONNEL.</b>		

• Explanation of Graphical Symbols

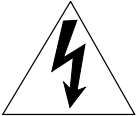

The lightning flash with arrowhead symbol, within an equilateral triangle, is intended to alert you to the presence of uninsulated "dangerous voltage" within the product's enclosure that may be of sufficient magnitude to constitute a risk of electric shock to persons.



The exclamation point within an equilateral triangle is intended to alert you to the presence of important operating and maintenance (servicing) instructions in the literature accompanying the appliance.

<b>WARNING</b> TO REDUCE THE RISK OF FIRE OR ELECTRIC SHOCK, DO NOT EXPOSE THIS APPLIANCE TO RAIN OR MOISTURE.
---

<b>IMPORTANT</b> Please record the serial number of this system in the space below. Model: Serial No.: The serial number is located on the rear of the main unit. Retain this Owner's Manual in a safe place for future reference.
---

- 1 Read these instructions.
- 2 Keep these instructions.
- 3 Heed all warnings.
- 4 Follow all instructions.
- 5 Do not use this apparatus near water.
- 6 Clean only with dry cloth.
- 7 Do not block any ventilation openings. Install in accordance with the manufacturer's instructions.
- 8 Do not install near any heat sources such as radiators, heat registers, stoves, or other apparatus (including amplifiers) that produce heat.
- 9 Do not defeat the safety purpose of the polarized or grounding-type plug. A polarized plug has two blades with one wider than the other. A grounding type plug has two blades and a third grounding prong. The wide blade or the third prong are provided for your safety. If the provided plug does not fit into your outlet, consult an electrician for replacement of the obsolete outlet.
- 10 Protect the power cord from being walked on or pinched particularly at plugs, convenience receptacles, and the point where they exit from the apparatus.
- 11 Only use attachments/accessories specified by the manufacturer.
- 12 Use only with the cart, stand, tripod, bracket, or table specified by the manufacturer, or sold with the apparatus. When a cart is used, use caution when moving the cart/ apparatus combination to avoid injury from tip-over. 
- 13 Unplug this apparatus during lightning storms or when unused for long periods of time.
- 14 Refer all servicing to qualified service personnel. Servicing is required when the apparatus has been damaged in any way, such as power-supply cord or plug is damaged, liquid has been spilled or objects have fallen into the apparatus, the apparatus has been exposed to rain or moisture, does not operate normally, or has been dropped.

- |   |
|---|
| <ul style="list-style-type: none"><li>• Be sure to allow spaces of at least 20 cm above, behind and on both sides of the unit.</li><li>• Do not place the following objects on this unit:<br/>A vessel with water in it.<br/>If the vessel falls by vibrations and water spills, it may cause damage to the unit, and/or you may get an electric shock.</li></ul> |
|---|

## FCC INFORMATION (for US customers only)

**1. IMPORTANT NOTICE : DO NOT MODIFY THIS UNIT!**

This product, when installed as indicated in the instructions contained in this manual, meets FCC requirements. Modifications not expressly approved by Yamaha may void your authority, granted by the FCC, to use the product.

**2. IMPORTANT :** When connecting this product to accessories and/or another product use only high quality shielded cables. Cable/s supplied with this product **MUST** be used. Follow all installation instructions. Failure to follow instructions could void your FCC authorization to use this product in the USA.

**3. NOTE :** This product has been tested and found to comply with the requirements listed in FCC Regulations, Part 15 for Class "B" digital devices. Compliance with these requirements provides a reasonable level of assurance that your use of this product in a residential environment will not result in harmful interference with other electronic devices.

This equipment generates/uses radio frequencies and, if not installed and used according to the instructions found in the users manual, may cause interference harmful to the operation of other electronic devices.

Compliance with FCC regulations does not guarantee that interference will not occur in all installations. If this product is found to be the source of interference, which can be determined by turning the unit "OFF" and "ON", please try to eliminate the problem by using one of the following measures:

Relocate either this product or the device that is being affected by the interference.

Utilize power outlets that are on different branch (circuit breaker or fuse) circuits or install AC line filter/s.

In the case of radio or TV interference, relocate/reorient the antenna. If the antenna lead-in is 300 ohm ribbon lead, change the lead-in to coaxial type cable.

If these corrective measures do not produce satisfactory results, please contact the local retailer authorized to distribute this type of product. If you can not locate the appropriate retailer, please contact Yamaha Electronics Corp., U.S.A. 6660 Orangethorpe Ave, Buena Park, CA 90620.

The above statements apply **ONLY** to those products distributed by Yamaha Corporation of America or its subsidiaries.

## We Want You Listening For A Lifetime



YAMAHA and the Electronic Industries Association's Consumer Electronics Group want you to get the most out of your equipment by playing it at a safe level. One that lets the sound come through loud and clear without annoying blaring or distortion – and, most importantly, without affecting your sensitive hearing.

Since hearing damage from loud sounds is often undetectable until it is too late, YAMAHA and the Electronic Industries Association's Consumer Electronics Group recommend you to avoid prolonged exposure from excessive volume levels.

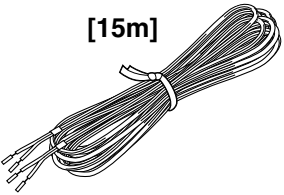
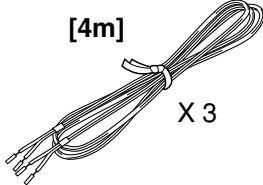

# UNPACKING

Please check to make sure all listed items are included.

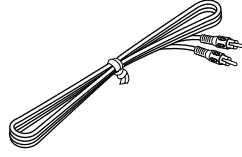
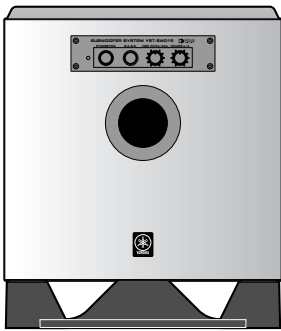
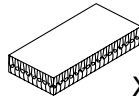
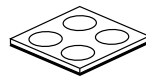
<p>Main and rear speakers (and rear center speaker for NS-P436)</p> <p><b>NX-430P</b></p>  <p>&lt;NS-P430&gt; X 4</p> <p>&lt;NS-P436&gt; X 5</p>	<p>Speaker cables</p> <p><b>[15m]</b></p>  <p>&lt;NS-P430&gt; X 2</p> <p>&lt;NS-P436&gt; X 3</p> <p><b>[4m]</b></p>  <p>X 3</p>
<p>Center speaker</p> <p><b>NX-C430</b></p> 	<p>Subwoofer cable</p> 
<p>Subwoofer</p> <p><b>YST-SW015</b></p> 	<p>Fasteners (for NX-C430)</p>  <p>X 2</p>
	<p>Nonskid pads (for YST-SW015)</p> 

### For Canadian Customers

To prevent electric shock, match wide blade of plug to wide slot and fully insert.

This Class B digital apparatus complies with Canadian ICES-003.

### For U.K. customers

If the socket outlets in the home are not suitable for the plug supplied with this appliance, it should be cut off and an appropriate 3 pin plug fitted. For details, refer to the instructions described below.

**Note:** The plug severed from the mains lead must be destroyed, as a plug with bared flexible cord is hazardous if engaged in a live socket outlet.

### SPECIAL INSTRUCTIONS FOR U.K. MODEL

#### IMPORTANT:

THE WIRES IN MAINS LEAD ARE COLOURED IN ACCORDANCE WITH THE FOLLOWING CODE:

Blue: NEUTRAL

Brown: LIVE

As the colours of the wires in the mains lead of this apparatus may not correspond with the coloured markings identifying the terminals in your plug, proceed as follows:

The wire which is coloured BLUE must be connected to the terminal which is marked with the letter N or coloured BLACK. The wire which is coloured BROWN must be connected to the terminal which is marked with the letter L or coloured RED. Making sure that neither core is connected to the earth terminal of the three pin plug.

## CAUTION: Read this before operating your unit.

- To assure the finest performance, please read this manual carefully. Keep it in a safe place for future reference.
- Install the speakers in a cool, dry, clean place – away from windows, heat sources, sources of excessive vibration, dust, moisture and cold. Avoid sources of humming (transformers, motors). To prevent fire or electric shock, do not expose the speakers to rain or water.
- To prevent the enclosure from warping or discoloring, do not place the speakers where they will be exposed to direct sunlight or excessive humidity.
- Avoid installing the speakers where foreign objects may fall onto them and/or where they may be exposed to liquid dripping or splashing.  
Do not place the following objects on top of the speakers:
  - Other components, as they might cause damage and/or discoloration on the surface of the speakers.
  - Burning objects (i.e. candles), as they might cause fire, damage to the speakers and/or personal injury.
  - Containers with liquid in them, as they might cause electric shock to the user and/or damage to the speakers.
- Do not place the speakers where they are liable to be knocked over or struck by falling objects. Stable placement will also ensure better sound performance.
- Placing the speakers on the same shelf or rack as the turntable can result in feedback.
- Secure placement or installation is the owner's responsibility. YAMAHA shall not be liable for any accident caused by improper placement or installation of speakers.
- Any time you note distortion, reduce the volume control on your amplifier to a lower setting. Never allow your amplifier to be driven into "clipping". Otherwise the speakers may be damaged.
- When using an amplifier with a rated output power higher than the nominal input power of the speakers, care should be taken never to exceed the speakers' maximum input.
- Do not attempt to clean the speakers with chemical solvents as this might damage the finish. Use a clean, dry cloth.
- Do not attempt to modify or fix the speakers. Contact qualified YAMAHA service personnel when any service is needed. The cabinet should never be opened for any reason.
- Be sure to read the "TROUBLESHOOTING" section regarding common operating errors before concluding that the speakers are faulty.
- Do not cover the rear panel of this unit with a newspaper, a tablecloth, a curtain, etc. in order not to obstruct heat radiation. If the temperature inside this unit rises, it may cause fire, damage to this unit and/or personal injury.
- Do not plug in this unit to a wall outlet until all connections are completed.
- The voltage to be used must be the same as that specified on the rear panel. Using this unit with a higher voltage than specified is dangerous and may cause fire, damage to this unit, and/or personal injury. YAMAHA will not be held responsible for any damage resulting from use of this unit with a voltage other than specified.
- To prevent lightning damage, disconnect the AC power plug when there is an electric storm.
- Super-bass frequencies reproduced by this unit may cause a turntable to generate a howling sound. In such a case, move this unit away from the turntable.
- This unit may be damaged if certain sounds are continuously outputted at high volume level. For example, if 20 Hz–50 Hz sine waves from a test disc, bass sounds from electronic instruments, etc. are continuously outputted, or when the stylus of a turntable touches the surface of a disc, reduce the volume level to prevent this unit from being damaged.
- If you hear distorted noise (i.e. unnatural, intermittent "rapping" or "hammering" sounds) coming from this unit, reduce the volume level. Extremely loud playing of a movie soundtrack's low frequency, bass-heavy sounds or similarly loud popular music passages can damage this speaker system.
- Vibration generated by super-bass frequencies may distort images on a TV. In such a case, move this unit away from the TV set.
- When disconnecting the power cord from the wall outlet, grasp the plug; do not pull the cord.
- When not planning to use this unit for a long period (i.e. vacation, etc.), disconnect the AC power plug from the wall outlet.
- **VOLTAGE SELECTOR**  
**(For China, Korean and General models)**  
**The voltage selector switch on the rear panel of this unit must be set for your local main voltage BEFORE plugging this unit into the AC main supply.**  
**Voltages are 110-120/220-240 V AC, 50/60 Hz.**

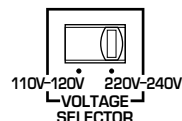

### For YST-SW015

- Do not operate this unit upside down. It may overheat, possibly causing damage.
- Do not use excessive force on switches, controls or connection wires. When moving this unit, first disconnect the power plug and the wires connected to other equipments. Never pull the wires themselves.
- Since this unit has a built-in power amplifier, heat will radiate from the rear panel. Place the unit apart from the walls, allowing spaces of at least 20 cm above, behind and on both sides of the unit to prevent fire or damage. Furthermore, do not position with the rear panel facing down on the floor or other surfaces.
- When using a humidifier, be sure to avoid condensation inside this unit by allowing enough spaces around this unit or avoiding excess humidification. Condensation might cause a fire, damage to this unit, and/or electric shock.

#### Standby mode

If the POWER switch is set to the ON position and the AUTO STANDBY switch is set to the HIGH or LOW position, this unit turns into the standby mode when no signal is received by this unit for 7 to 8 minutes.  
In this state, this unit is designed to consume a very small quantity of power.

#### WARNING

TO REDUCE THE RISK OF FIRE OR ELECTRIC SHOCK, DO NOT EXPOSE THIS UNIT TO RAIN OR MOISTURE.

# COMPONENTS OF THE PACKAGE

The speaker package “NS-P430 and NS-P436” is designed for use in a multi-channel audio system such as a home theater system.

NS-P430 includes four NX-430P speaker systems, one NX-C430 speaker system and one YST-SW015 subwoofer system.

NS-P436 includes five NX-430P speaker systems, one NX-C430 speaker system and one YST-SW015 subwoofer system.

## <NX-430P>

**2-way acoustic-suspension speaker system used for the main and rear speakers (and rear center speaker for NS-P436)**

## <NX-C430>

**2-way acoustic-suspension speaker system used for the center speaker**

## <YST-SW015>

**Active Servo Processing Subwoofer System with a built-in power amplifier**

- This subwoofer system employs Advanced Yamaha Active Servo Technology which YAMAHA has developed for reproducing higher quality super-bass sound. (Refer to page 14 for details on Advanced Yamaha Active Servo Technology.) This super-bass sound adds a more realistic, theater-in-the-home effect to your stereo system.
- The HIGH CUT control enables you to adjust the tone balance between the subwoofer and the main speakers.
- The Automatic power-switching function saves you the trouble of pressing the STANDBY/ON button to turn the power on or turn it to the STANDBY mode.

**QD·Bass**  
TECHNOLOGY

### QD-Bass Technology

QD-Bass (Quatre Dispersion Bass) technology uses square, pyramid-shaped reflective plates to radiate the sound in four horizontal directions.

# CONTENTS

<b>IMPORTANT SAFETY INSTRUCTIONS</b> .....	<b>II</b>	<b>CONNECTIONS</b> .....	<b>7</b>
<b>UNPACKING</b> .....	<b>IV</b>	An example of basic connections .....	7
<b>CAUTION</b> .....	<b>1</b>	How to connect speaker cables to the input and output terminals of the speakers .....	9
<b>COMPONENTS OF THE PACKAGE</b> .....	<b>2</b>	<b>USING THE SUBWOOFER (YST-SW015)</b> ...	<b>10</b>
<b>SETTING UP THE SPEAKERS</b> .....	<b>3</b>	Controls and their functions .....	10
Placing the subwoofer .....	4	Automatic power-switching function .....	11
Placing the center speaker .....	4	Adjusting the subwoofer before use .....	12
Mounting the main/rear/center speakers (and rear center speaker for NS-P436) on a wall .....	5	Frequency characteristics .....	13
Mounting the main/rear speakers (and rear center speaker for NS-P436) by using commercially available speaker stands or brackets .....	6	<b>ADVANCED YAMAHA ACTIVE SERVO TECHNOLOGY (for YST-SW015)</b> .....	<b>14</b>
		<b>TROUBLESHOOTING</b> .....	<b>15</b>
		<b>SPECIFICATIONS</b> .....	<b>Back Cover</b>

## ■ About this manual

- This manual is printed prior to production. Design and specifications are subject to change in part for the reason of the improvement in operativity ability, and others. In this case, the product has priority.
- Some of the illustrations and names of the package contents etc. written in this manual may differ from the actual products and the names written on the package etc.

# SETTING UP THE SPEAKERS

Before making connections, place all speakers in their respective positions. The positioning of the speakers is important because it controls the whole sound quality of this system.

Place the speakers depending on your listening position by following the instructions below.

## Speaker configuration

### <NS-P430>

This speaker package employs a 6 speaker configuration: 2 main speakers, 2 rear speakers, a center speaker and a subwoofer.

The main speakers emit main source sound. The rear speakers emit surround sounds, and the center speaker emits center sounds (dialog etc.). The subwoofer emits reinforcing low frequencies on your audio system.

### <NS-P436>

This speaker package employs a 7 speaker configuration: 2 main speakers, 2 rear speakers, a center speaker, a rear center speaker and a subwoofer.

The main speakers emit main source sound. The rear and rear center speakers emit surround sounds, and the center speaker emits center sounds (dialog etc.). The subwoofer emits reinforcing low frequencies on your audio system.

### Note

In this speaker package, the same speakers (NX-430P) are used for the main and rear speakers (and rear center speaker for NS-P436).

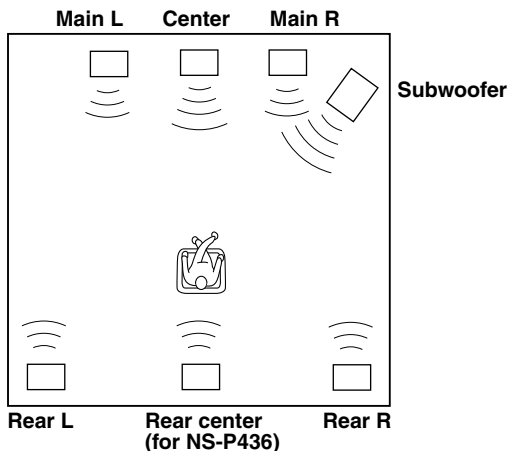

## Placing speakers

**Main speakers:** On both sides of and at approximately the same height as the TV set.

**Rear speakers:** Behind your listening position, facing slightly inward. About 1.8 m (approx. 6 feet) from the floor.

**Center speaker:** Precisely between the main speakers.

### Rear center speaker (for NS-P436):

Precisely between the rear speakers.

### Subwoofer:

The position of the subwoofer is not so critical because low bass tones are not highly directional.

Refer to "Placing the subwoofer" on page 4 for a recommended positioning of the subwoofer.

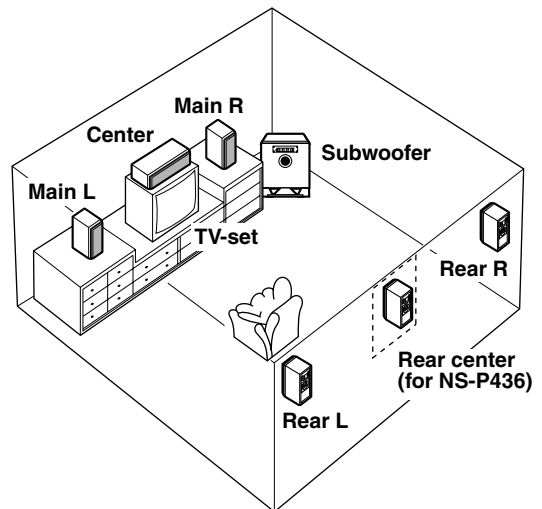

These speakers feature a magnetically shielded design, but there is still a chance that placing them too close to a TV set might impair picture color. Should this happen, move the speakers away from the TV set.

## ■ Placing the subwoofer

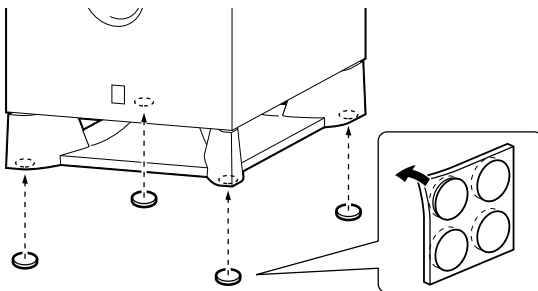
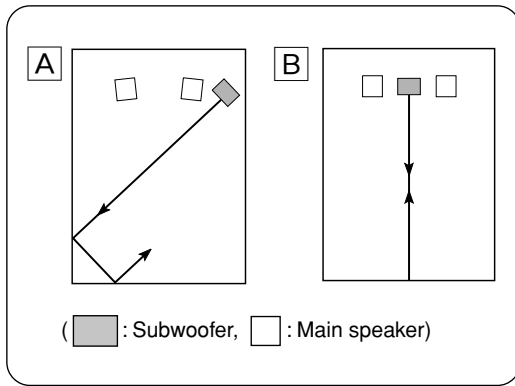

It is recommended to place the subwoofer on the outside of either the right or the left main speaker. (See fig. [A].) The placement shown in fig. [B] is also possible, however, if the subwoofer system is placed directly facing the wall, the bass effect may die because the sound from it and the sound reflected by the wall may cancel out each other. To prevent this from happening, face the subwoofer system at an angle as shown in fig. [A].

### Note

There may be a case that you cannot obtain enough super-bass sounds from the subwoofer when listening in the center of the room. This is because “standing waves” have been developed between two parallel walls and they cancel the bass sounds.

In such a case, face the subwoofer obliquely to the wall. It also may be necessary to break up the parallel surfaces by placing bookshelves etc. along the walls.

### Use the nonskid pads

Put the provided nonskid pads at the four corners on the bottom of the subwoofer to prevent the subwoofer from moving by vibrations etc.

## ■ Placing the center speaker

You can place the speaker on top of the TV if the top is flat, on the floor under the TV, or inside the TV rack. Be sure to place the speaker in a stable position.

When placing the speaker on top of the TV, to prevent the speaker from falling, attach the provided fasteners at two points on the bottom of the speaker and on the top of the TV.

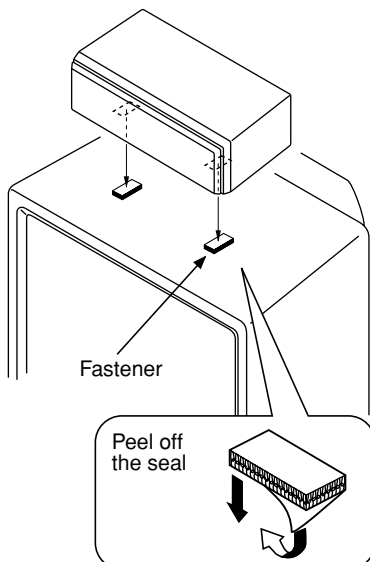

### Notes

- Do not place the speaker on top of a TV whose area is smaller than the bottom of the speaker. If placed, the speaker may fall and cause injury.
- Do not place the speaker on top of a TV if the top is inclined.
- Do not touch the adhesive surface after peeling off the seal as this will weaken its adhesive strength.
- Thoroughly wipe clean the surface where the fastener is to be applied. Note that adhesive strength is weakened if the surface is dirty, oily or wet and that this may cause the center speaker to fall.

# ■ Mounting the main/rear/center speakers (and rear center speaker for NS-P436) on the wall

**1** Tapping screw  
(Available at the hardware store)

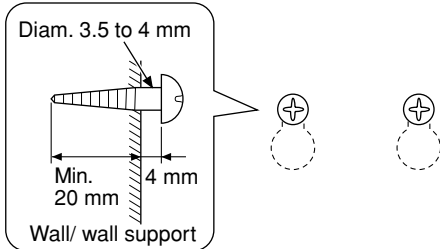

**2**

**Main/rear/rear center (for NS-P436)**

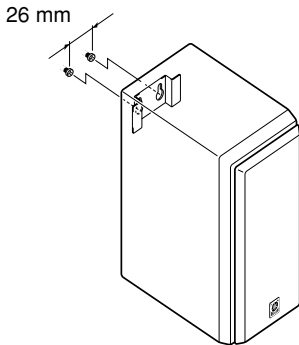

**Center**

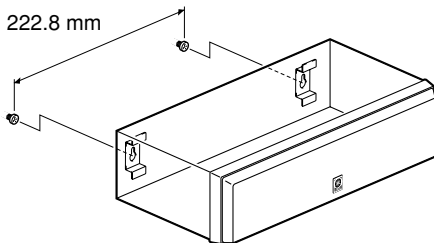

You can mount the main, rear and/or center speakers (and/or rear center speaker for NS-P436) on a wall. To mount the speakers on a wall, use the holes of the brackets attached on the speakers' back panels.

**Main/rear/rear center (for NS-P436)**

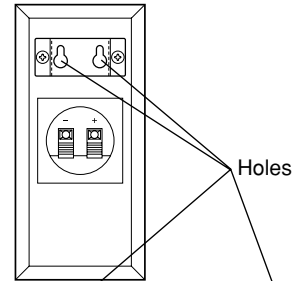

**Center**

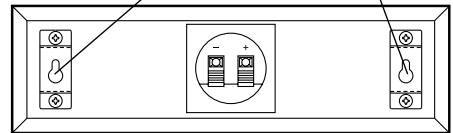

- 1** Fasten two screws into a firm wall or wall support at the interval shown below.
 

Main/rear/rear center (for NS-P436)	..... 26 mm (1")
Center	..... 222.8 mm (8-3/4")
- 2** Hang the speaker by mounting the holes on the protruding screws.
  - \* Make sure that the screws are securely affixed by the narrow parts of the holes.

**WARNING**

- Each speaker weighs as follows.
 

Main/rear/rear center (for NS-P436)	..... 1.2 kg (2 lbs. 10 oz.)
Center	..... 1.7 kg (3 lbs. 12 oz.)
- Do not mount them on thin plywood or a wall composed of a soft surface material. If mounted, the screws may pull out of the flimsy surface and the speakers may fall. This may damage the speakers or cause personal injury.
- Do not affix the speakers to a wall using nails, adhesives, or any other unstable hardware. Long-term use and vibrations may cause the speakers to fall.
- To avoid accidents resulting from tripping over loose speaker cables, fix the cables to the wall.
- Select an appropriate position on the wall to mount the speaker so that no one will injure his/her head or face.



## ■ Mounting the main/rear speakers (and rear center speaker for NS-P436) by using commercially available speaker stands or brackets

You can also use the screw holes on the bottom of the speaker for installing the speakers on commercially available speaker stands (if you do not use the attached mounting brackets.)

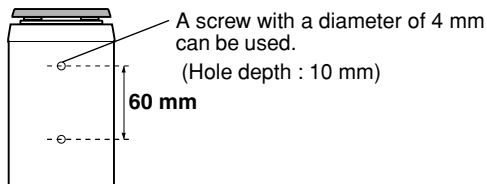

### Using the Yamaha Speaker Stand SPS-10MM (option)

By using the Yamaha Speaker Stand SPS-10MM, speakers can be placed on the floor. (Two stands make a set.)

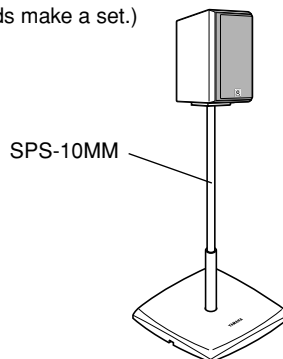

\* The SPS-10MM is not available in some areas.

## Removing the front cover

### Main/rear/rear center (for NS-P436)

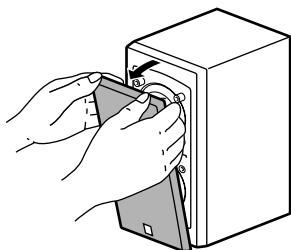

### Center

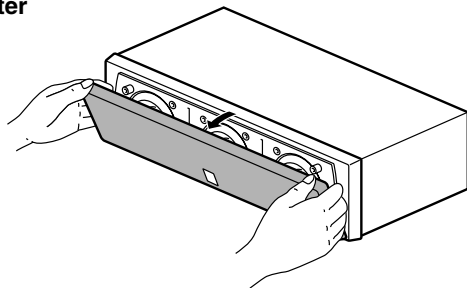

The front cover is fastened to the enclosure at four points and can be removed if desired. To remove the cover, hold on to both sides and slowly pull straight away from the speaker. To reattach, line up the four holes on the inner surface of the cover with the four corresponding pegs on the speaker and push gently.

#### Note

**When the cover is removed, be sure not to touch the speaker units with your hands or to exert excessive force with tools.**

# CONNECTIONS

**Caution:** Plug in the subwoofer and other audio/video components after all connections are completed.

## ■ An example of basic connections

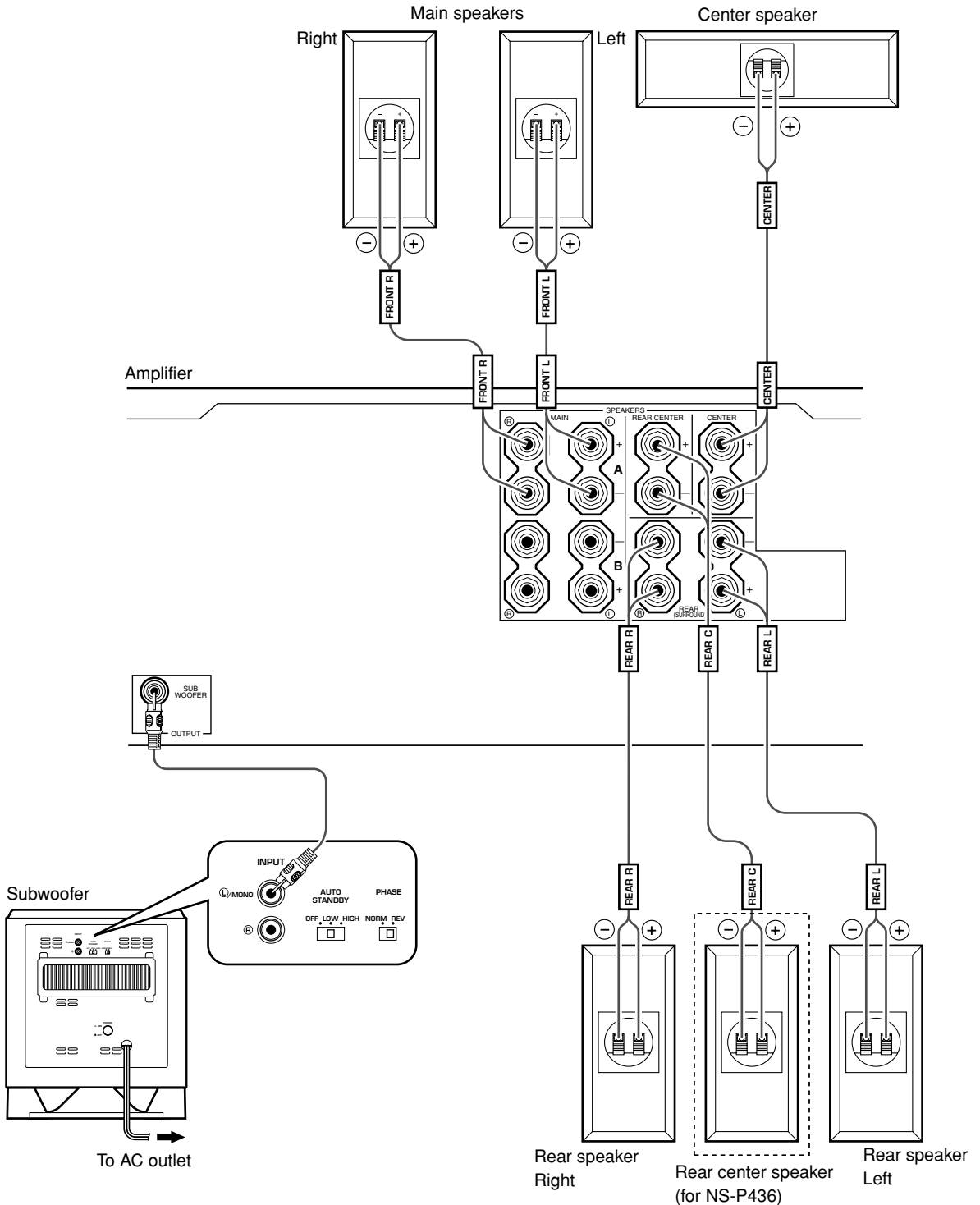

- Connect the main, center and rear speakers (and rear center speaker for NS-P436) to the speaker output terminals of your amplifier with the provided speaker cables.
  - \* The provided speaker cables have labels marked FRONT L, FRONT R, CENTER, REAR L, REAR R (and REAR C for NS-P436). Connect each speaker cable to the corresponding speaker by following the figure on page 7.
 

(The speaker cables marked FRONT L/R are used for connecting the main speakers to the MAIN speakers' terminals on the amplifier.)
  - \* Connect each speaker making sure not to reverse the polarity (+, -). If the speaker is connected with reversed polarity, the sound will be unnatural and lack bass.
  - \* For the main and rear speakers only, connect one speaker to the left (marked L) terminals of your amplifier, and another speaker to the right (marked R) terminals.

- Connect the subwoofer to the line output (pin jack) terminal(s) of the amplifier.
  - \* To connect with a YAMAHA DSP amplifier (or AV receiver), connect the SUBWOOFER (or LOW PASS etc.) terminal on the rear of the DSP amplifier (or AV receiver) to the  $\text{L}$ /MONO INPUT terminal of the subwoofer.
  - \* To connect the subwoofer to the SPLIT SUBWOOFER terminals on the rear of the DSP amplifier, connect them to both the left  $\text{L}$ /MONO and right  $\text{R}$  INPUT terminals of the subwoofer.

**Note**

When connecting to a monaural line output terminal of the amplifier, connect to the  $\text{L}$ /MONO INPUT terminal.

## ■ How to connect speaker cables to the input terminals of the speakers

For connections, keep the speaker cables as short as possible. Do not bundle or roll up the excess part of the cables. If the connections are faulty, no sound will be heard from the speakers.

### Main speakers

#### Center speaker

Use the provided speaker cables (4 m). One side of the speaker cable is red and the other side is black. Connect the (+) terminals on both the speaker and the amplifier using the red side of the cable. Connect the (-) terminals on both components using the black side.

Red: positive (+)  
Black: negative (-)

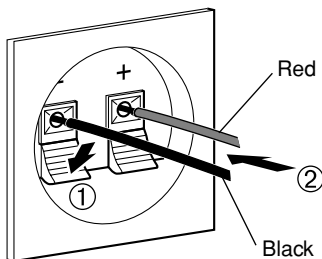

### Rear speakers

#### Rear center speaker (for NS-P436)

Use the provided speaker cables (15 m). One side of the speaker cable has a gray line and the other side has no line. Connect the (+) terminals on both the speaker and the amplifier using the side with a gray line. Connect the (-) terminals on both components using the side with no line.

Red: positive (+)  
Black: negative (-)

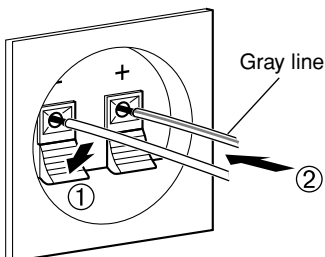

### Before connecting

Remove the insulation coating at the extremity of each speaker cable by twisting the coating off.

**Good**      **No Good**



### How to Connect:

- ① Press and hold the terminal's tab, as shown in the figure.
- ② Insert the bare wire.
- ③ Release your finger from the tab to allow it to lock securely on the cable's wire end.
- ④ Test the firmness of the connection by pulling lightly on the cable at the terminal.

### Note

**Do not let the bare speaker wires touch each other as this could damage the speaker or the amplifier, or both of them.**

# USING THE SUBWOOFER (YST-SW015)

## ■ Controls and their functions

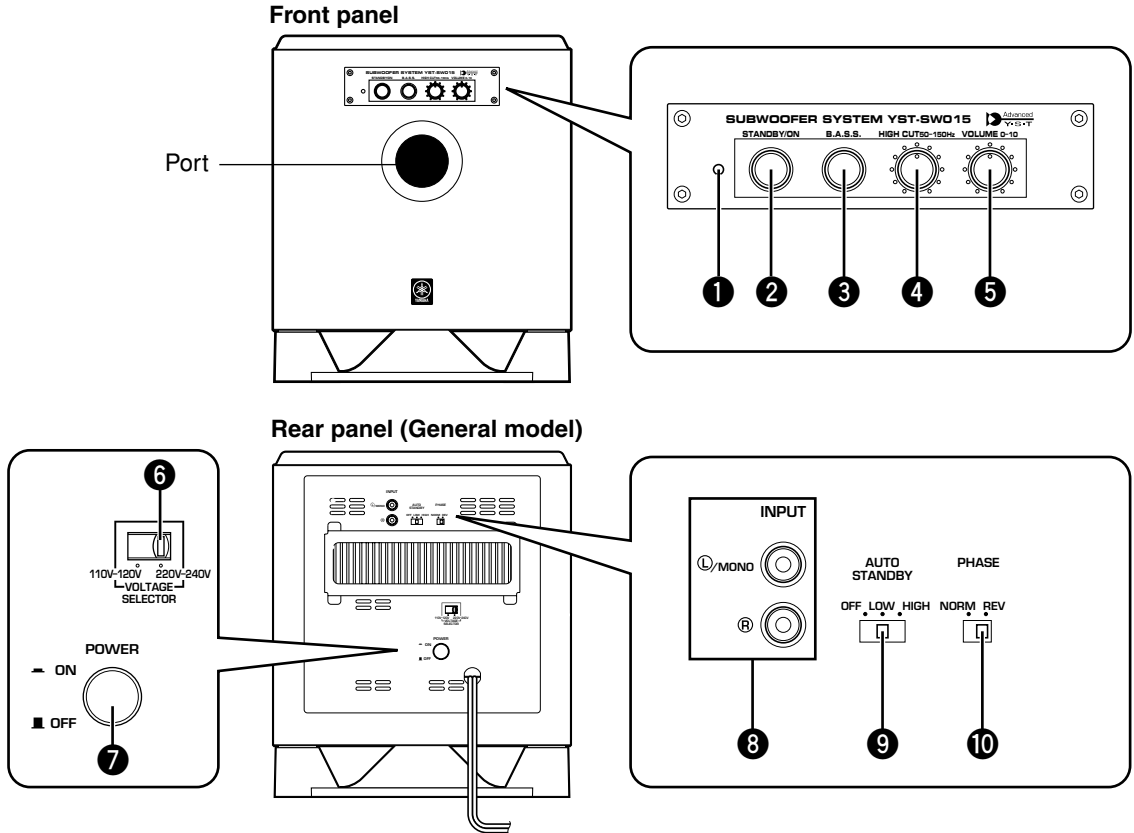

**1** **Power indicator**  
Lights up in green while the subwoofer is on.  
Lights up in red while the subwoofer is set in the standby mode by the operation of the automatic power-switching function.  
Goes off when the subwoofer is set in the standby mode.

**2** **STANDBY/ON button**  
Press this button to turn on the power when the **POWER (7)** switch is set in the ON position. (The power indicator lights up in green.)  
Press again to set the subwoofer in the standby mode. (The power indicator goes off.)

Standby mode

The subwoofer is still using a small amount of power in this mode.

**3** **B.A.S.S.** (Bass Action Selector System) button  
When this button is pressed in to the MUSIC position, the bass sound in audio software is well reproduced.  
By pressing the button again so that it pops out at the MOVIE position, the bass sound in video software is well reproduced.



**4** **HIGH CUT control**  
Adjusts the high frequency cut off point.  
Frequencies higher than the frequency selected by this control are all cut off (and no output).  
\* One graduation of this control represents 10 Hz.

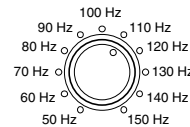

**5** **VOLUME control**  
Adjusts the volume level. Turn the control clockwise to increase the volume, and counterclockwise to decrease the volume.

**6** **VOLTAGE SELECTOR switch**  
**(For China, Korean and General models)**  
If the preset setting of the switch is incorrect, set the switch to the proper voltage range (220V-240V or 110V-120V) of your area.  
Consult your dealer if you are unsure of the correct setting.

### WARNING

**Be sure to unplug the subwoofer before setting the VOLTAGE SELECTOR switch correctly.**

- 7 POWER** switch  
Normally, set this switch to the ON position to use the subwoofer. In this state, you can turn on the subwoofer or turn the subwoofer into the standby mode by pressing the **STANDBY/ON** (2) button. Set this switch to the OFF position to completely cut off the subwoofer's power supply from the AC line.
- 8 INPUT** terminals  
Used to input line level signals from the amplifier.  
(Refer to "**CONNECTIONS**" for details.)
- 9 AUTO STANDBY (HIGH/LOW/OFF)** switch  
This switch is originally set to the OFF position. By setting this switch to the HIGH or LOW position, the subwoofer's automatic power-switching function operates as described below. If you do not need this function, leave this switch in the OFF position.  
\* Make sure to change the setting of this switch only when the subwoofer is set in the standby mode by pressing the **STANDBY/ON** (2) button.
- 10 PHASE** switch  
Normally this switch is to be set to the REV (reverse) position. However, according to the listening condition or your preference, there may be a case when better sound quality is obtained by setting this switch to the NORM (normal) position. Select the better position by monitoring the sound.

## ■ Automatic power-switching function

If the source being played is stopped and the input signal is cut off for 7 to 8 minutes, the subwoofer automatically switches to the standby mode. (When the subwoofer switches to the standby mode by the automatic power-switching function, the power indicator lights up in red.) When you play a source again, the power of the subwoofer turns on automatically by sensing audio signals input to the subwoofer.

This function operates by sensing a certain level of low frequency input signal. Usually set the **AUTO STANDBY** switch to the LOW position. However, if this function does not operate smoothly, set the switch to the HIGH position. In the HIGH position, the power will turn on even with a low level of input signal. But please be aware that the subwoofer may not switch to the standby mode when there is an extremely low input signal.

- \* The power might turn on unexpectedly by sensing noise from other appliances. If that occurs, set the **AUTO STANDBY** switch to the OFF position and use the **STANDBY/ON** button to switch the power between on and in the standby mode manually.
- \* This function detects the low-frequency components below 200 Hz of the input signals (i.e., the explosion in the action movie, the sound of the bass guitar or the bass drum, etc.).
- \* The minutes required to switch the subwoofer to the standby mode might change by sensing noise from other appliances.

**This function is available only when the power of the subwoofer is on (by pressing the STANDBY/ON button).**

## ■ Adjusting the subwoofer before use

Before using the subwoofer, adjust the subwoofer to obtain the optimum volume and tone balance between the subwoofer and the main speakers by following the procedures described below.

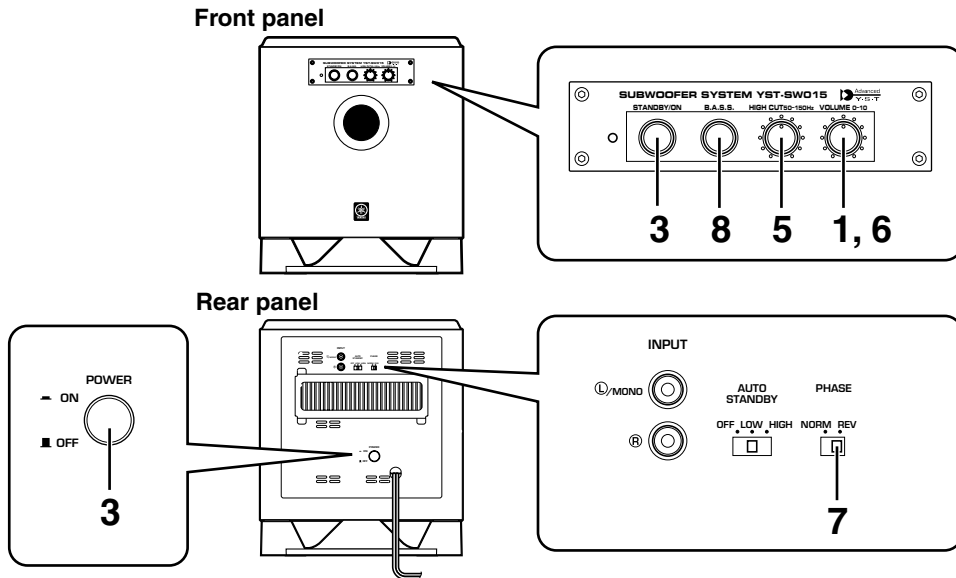

**1** Set the **VOLUME** control to minimum (0).

**2** Turn on the power of all the other components.

**3** Make sure that the **POWER** switch is set to the ON position, then press the **STANDBY/ON** button to turn on the subwoofer.

\* The Power indicator lights up in green.

**4** Play a source containing low-frequency components and adjust the amplifier's volume control to the desired listening level.

**5** Adjust the **HIGH CUT** control to the position where the desired response can be obtained.

This system is designed so that the optimum tone balance between the subwoofer and the main speakers (NX-430P) is obtained when this control is set at 110 Hz. However, the tone balance may change depending on the room size, the distance from the subwoofer to the main speakers, etc. So, if you prefer, turn the **HIGH CUT** control and set it to a position where a better tone balance is obtained.

**6** Increase the volume gradually to adjust the volume balance between the subwoofer and the main speakers.

**7** Set the **PHASE** switch to the position which gives you the better bass sound.

Normally, set the switch to the REV (reverse) position. If the desired response cannot be obtained, set the switch to the NORM (normal) position.

**8** Select "MOVIE" or "MUSIC" according to the played source.

**MOVIE:** When a movie type source is played, the low-frequency effects are enhanced to allow the listener enjoy more powerful sound. (The sound will be thicker and deeper.)

**MUSIC:** When an ordinary music source is played, the excessive low-frequency components are cut off to make the sound clearer. (The sound will be lighter and reproduces the melody line more clearly.)

- **Once the volume balance between the subwoofer and the main speakers is adjusted, you can adjust the volume of your whole sound system by using the amplifier's volume control.**

**However, if you change the main speakers NX-430P to others, you must make this adjustment again.**

- **For adjusting the VOLUME control, the HIGH CUT control and the PHASE switch, refer to "Frequency characteristics" on the next page.**

## ■ Frequency characteristics

Adjustment of the **VOLUME** control, the **HIGH CUT** control and the **PHASE** switch should be changed depending on the room size, the distance from the subwoofer to the main speakers, sources, etc.

Following figures show the optimum adjustment of each control and the frequency characteristics when this subwoofer is combined with NX-430P.

### Frequency characteristics of this subwoofer (YST-SW015)

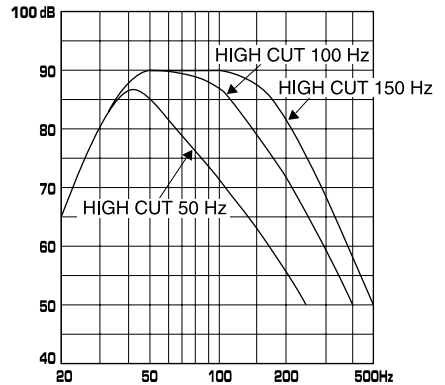

### • When combined with NX-430P

HIGH CUT 50-150Hz VOLUME 0-10

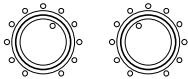

**PHASE**—Set to the REV (reverse) position.  
**B.A.S.S.—MOVIE**

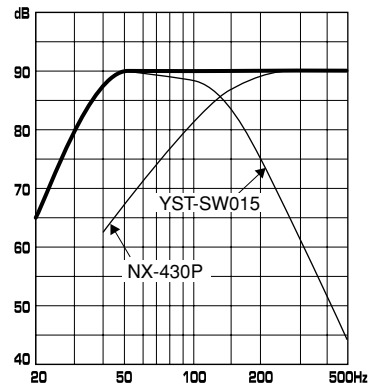



# ADVANCED YAMAHA ACTIVE SERVO TECHNOLOGY (for YST-SW015)

The theory of Yamaha Active Servo Technology has been based upon two major factors, the Helmholtz resonator and negative-impedance drive. Active Servo Processing speakers reproduce the bass frequencies through an “air woofer”, which is a port or opening in the speaker’s cabinet. This opening is used instead of, and performs the functions of, a woofer in a conventionally designed speaker system. Thus, signals of low amplitude within the cabinet can, according to the Helmholtz resonance theory, be outputted from this opening as waves of great amplitude if the size of the opening and the volume of the cabinet are in the correct proportion to satisfy a certain ratio.

In order to accomplish this, moreover, the amplitudes within the cabinet must be both precise and of sufficient power because these amplitudes must overcome the “load” presented by the air that exists within the cabinet.

Thus it is this problem that is resolved through the employment of a new design in which the amplifier supplies special signals. If the electrical resistance of the voice coil could be reduced to zero, the movement of the speaker unit would become linear with respect to signal voltage. To accomplish this, a special negative-impedance output-drive amplifier for subtracting output impedance of the amplifier is used. By employing negative-impedance drive circuits, the

amplifier is able to generate precise, low-amplitude, low-frequency waves with superior damping characteristics. These waves are then radiated from the cabinet opening as high-amplitude signals. The system can, therefore, by employing the negative-impedance output drive amplifier and a speaker cabinet with the Helmholtz resonator, reproduce an extremely wide range of frequencies with amazing sound quality and less distortion. The features described above, then, are combined to be the fundamental structure of the conventional Yamaha Active Servo Technology.

Our new Active Servo Technology — Advanced Yamaha Active Servo Technology — adopted Advanced Negative Impedance Converter (ANIC) circuits, which allows the conventional negative impedance converter to dynamically vary in order to select an optimum value for speaker impedance variation. With this new ANIC circuits, Advanced Yamaha Active Servo Technology can provide more stable performance and improved sound pressure compared with the conventional Yamaha Active Servo Technology, resulting in more natural and dynamic bass reproduction.

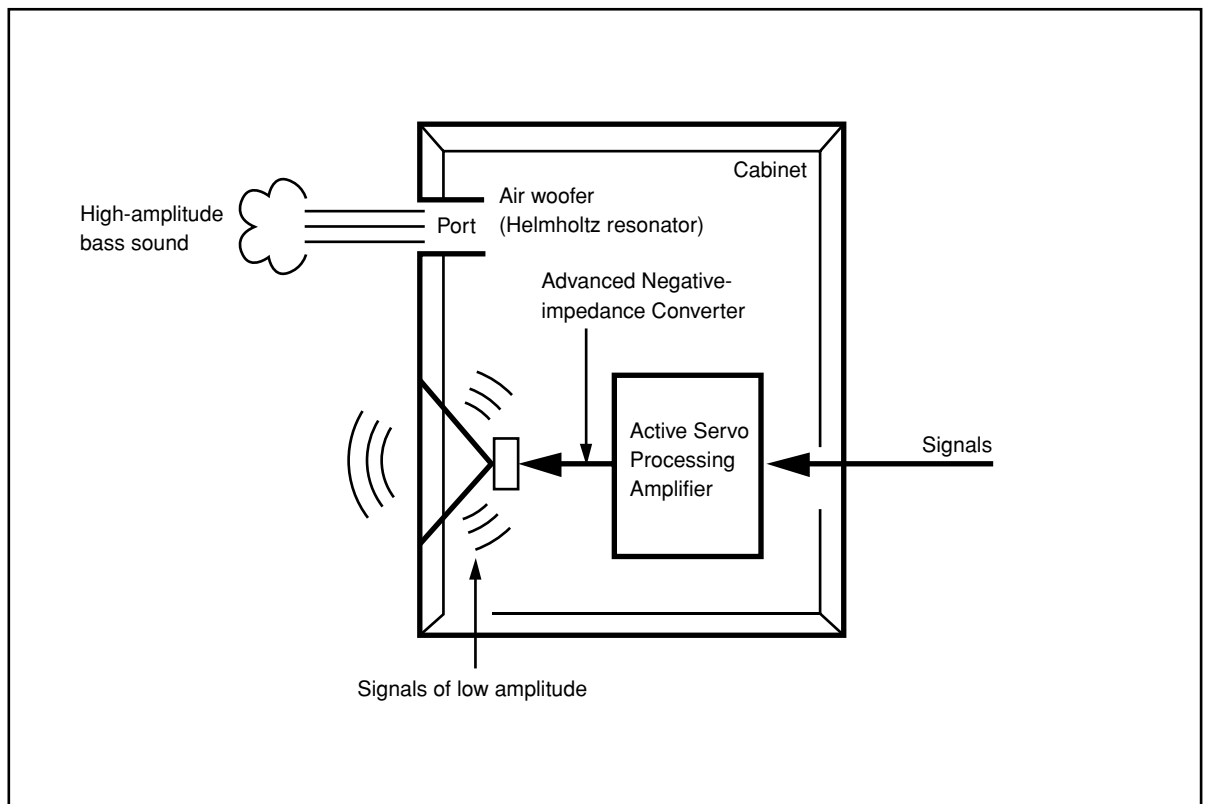

# TROUBLESHOOTING

Refer to the chart below when this unit does not function properly. If the problem you are experiencing is not listed below or if the instructions given below do not help, disconnect the power cord and contact your authorized YAMAHA dealer or service center.

Problem	Cause	What to Do
<b>No sound.</b>	Speaker cables are not connected securely.	Connect them securely.
<b>Sound level is too low.</b>	Speaker cables are not connected correctly.	Connect them correctly, that is L (left) to L, R (right) to R, "+" to "+" and "-" to "-".

## For YST-SW015

Problem	Cause	What to Do
<b>Power is not supplied even though the STANDBY/ON button is set to the ON position.</b>	The power plug is not securely connected.	Connect it securely.
	The POWER switch is set to the OFF position.	Set the POWER switch to the ON position.
<b>No sound.</b>	The VOLUME control is set to 0.	Turn the VOLUME control to the right.
	Speaker cables are not connected securely.	Connect them securely.
<b>Sound level is too low.</b>	Speaker cables are not connected correctly.	Connect them correctly, that is L (left) to L, R (right) to R, "+" to "+" and "-" to "-".
	Setting of the PHASE switch is not proper.	Set the switch to the other position.
	A source sound with few bass frequencies is played.	Play a source sound with bass frequencies. Set the HIGH CUT control to a higher position.
	It is influenced by standing waves.	Reposition the subwoofer or break up the parallel surface by placing bookshelves etc. along the walls.
<b>The subwoofer does not turn on automatically.</b>	The POWER switch is set to the OFF position.	Set the POWER switch to the ON position.
	The STANDBY/ON button is set to the OFF position.	Set the STANDBY/ON button to the ON position.
	The AUTO STANDBY switch is set to the OFF position.	Set the AUTO STANDBY switch to the "HIGH" or "LOW" position.
	The level of input signal is too low.	Set the AUTO STANDBY switch to the "HIGH" position.
<b>The subwoofer does not turn into the standby mode automatically.</b>	There is an influence of noise generated from external appliances etc.	Move the subwoofer further away from such appliances and/or reposition the connected speaker cables. Otherwise, set the AUTO STANDBY switch to the "OFF" position.
	The AUTO STANDBY switch is set to the OFF position.	Set the AUTO STANDBY switch to the "HIGH" or "LOW" position.
<b>The subwoofer turns into the standby mode unexpectedly.</b>	The level of input signal is too low.	Set the AUTO STANDBY switch to the "HIGH" position.
<b>The subwoofer turns on unexpectedly.</b>	There is an influence of noise generated from external appliances etc.	Move the subwoofer farther away from such appliances and/or reposition the connected speaker cables. Otherwise, set the AUTO STANDBY switch to the "OFF" position.

# SPECIFICATIONS

## ■ NX-430P, NX-C430

**Type** ..... 2-way acoustic-suspension speaker system  
Magnetic shielding type

### Driver

<NX-430P> ..... Coaxial 2-way [5 cm (2") cone  
and 1.3 cm (1/2") dome] speaker x 1  
5 cm (2") full range cone speaker x 1  
<NX-C430> ..... Coaxial 2-way [5 cm (2") cone  
and 1.3 cm (1/2") dome] speaker x 1  
5 cm (2") full range cone speaker x 2

**Nominal Input Power** ..... 30W

**Maximum Input Power** ..... 100W

**Impedance** ..... 6Ω

**Frequency Response** ..... 70 Hz to 60 kHz

### Sensitivity

<NX-430P> ..... 85 dB/2.83V/m  
<NX-C430> ..... 86 dB/2.83V/m

### Dimensions (W x H x D)

<NX-430P> ..... 87 mm x 184 mm x 147 mm  
(3-7/16" x 7-1/4" x 5-13/16")  
<NX-C430> ..... 273 mm x 81 mm x 147 mm  
(10-3/4" x 3-3/16" x 5-13/16")

### Weight

<NX-430P> ..... 1.2 kg (2 lbs. 10 oz.)  
<NX-C430> ..... 1.7 kg (3 lbs. 12 oz.)

## ■ YST-SW015

**Type** ..... Advanced Yamaha Active Servo Technology  
Magnetic shielding type

**Driver** ..... 16 cm (6-1/2") cone woofer

**Amplifier Output** ..... 70 W/5Ω

**Frequency Response** ..... 30 Hz to 200 Hz

### Power Supply

**U.S.A. and Canada models** ..... AC 120V, 60 Hz  
**U.K. and Europe models** ..... AC 230V, 50 Hz  
**Australia model** ..... AC 240V, 50 Hz  
**China, Korean and General models**  
..... AC 110-120/220-240V, 50/60 Hz

**Power Consumption** ..... 70 W

**Standby Power Consumption** ..... 0.8 W

**Dimensions (W x H x D)** ..... 280 mm x 325 mm x 320 mm  
(11" x 12-13/16" x 12-5/8")

**Weight** ..... 9.2 kg (20 lbs. 4 oz.)

\* Specifications are subject to change without notice due to product improvements.

