

LK-120

LK-125

USER'S GUIDE

GUÍA DEL USUARIO

Please keep all information for future reference.

Guarde toda información para tener como referencia futura.



GUIDELINES LAID DOWN BY FCC RULES FOR USE OF THE UNIT IN THE U.S.A. (not applicable to other areas).

NOTICE

This equipment has been tested and found to comply with the limits for a Class B digital device, pursuant to Part 15 of the FCC Rules. These limits are designed to provide reasonable protection against harmful interference in a residential installation. This equipment generates, uses and can radiate radio frequency energy and, if not installed and used in accordance with the instructions, may cause harmful interference to radio communications. However, there is no guarantee that interference will not occur in a particular installation. If this equipment does cause harmful interference to radio or television reception, which can be determined by turning the equipment off and on, the user is encouraged to try to correct the interference by one or more of the following measures:

- Reorient or relocate the receiving antenna.
- Increase the separation between the equipment and receiver.
- Connect the equipment into an outlet on a circuit different from that to which the receiver is connected.
- Consult the dealer or an experienced radio/TV technician for help.

FCC WARNING

Changes or modifications not expressly approved by the party responsible for compliance could void the user's authority to operate the equipment.

Important!

Please note the following important information before using this product.

- Before using the optional AD-E95100L Adaptor to power the unit, be sure to check the AC Adaptor for any damage first. Carefully check the power cord for breakage, cuts, exposed wire and other serious damage. Never let children use an AC adaptor that is seriously damaged.
- Never attempt to recharge batteries.
- Do not use rechargeable batteries.
- Never mix old batteries with new ones.
- Use recommended batteries or equivalent types.
- Always make sure that positive (+) and negative (-) poles are facing correctly as indicated near the battery compartment.
- Replace batteries as soon as possible after any sign they are getting weak.
- Do not short-circuit the battery terminals.
- The product is not intended for children under 3 years.
- Use only CASIO AD-E95100L adaptor.
- The AC adaptor is not a toy.
- Be sure to disconnect the AC adaptor before cleaning the product.



This mark applies in EU countries only.



Manufacturer:
CASIO COMPUTER CO.,LTD.
6-2, Hon-machi 1-chome, Shibuya-ku, Tokyo 151-8543, Japan
Responsible within the European Union:
CASIO EUROPE GmbH
Casio-Platz 1, 22848 Norderstedt, Germany

Safety Precautions

Before using the instrument, be sure to carefully read through the instructions contained in this manual.

Symbols

Various symbols are used in this user's guide and on the product itself to ensure that the product is used safely and correctly, and to prevent injury to the user and other persons as well as damage to property. Those symbols along with their meanings are shown below.

DANGER

This symbol indicates information that, if ignored or applied incorrectly, creates the danger of death or serious personal injury.

WARNING

This indication stipulates matters that have the risk of causing death or serious injury if the product is operated incorrectly while ignoring this indication.

CAUTION

This indication stipulates matters that have the risk of causing injury as well as matters for which there is the likelihood of occurrence of physical damage only if the product is operated incorrectly while ignoring this indication.

Symbol Examples



This triangle symbol (\triangle) means that the user should be careful. (The example at left indicates electrical shock caution.)



This circle with a line through it (\otimes) means that the indicated action must not be performed. Indications within or nearby this symbol are specifically prohibited. (The example at left indicates that disassembly is prohibited.)



The black dot (\bullet) means that the indicated action must be performed. Indications within this symbol are actions that are specifically instructed to be performed. (The example at left indicates that the power plug must be unplugged from the electrical socket.)

DANGER

Alkaline Batteries

Perform the following steps immediately if fluid leaking from alkaline batteries ever gets into your eyes. 

1. Do not rub your eyes! Rinse them with water.
2. Contact your physician immediately.

Leaving alkaline battery fluid in your eyes can lead to loss of sight.

WARNING



Smoke, Strange Odor, Overheating

Continued use of the product while it is emitting smoke, a strange odor, or heat creates the risk of fire and electric shock. Take the following steps immediately.



1. Turn off power.
2. If you are using the AC adaptor for power, unplug it from the wall outlet.
3. Contact your original retailer or an authorized CASIO Service Provider.

AC Adaptor

● Misuse of the AC adaptor creates the risk of fire and electric shock. Always make sure you observe the following precautions.

- Be sure to use only the AC adaptor that is specified for this product. 
- Use only a power source whose voltage is within the rating marked on the AC adaptor.
- Do not overload electrical outlets and extension cords. 

● Misuse of the AC adaptor's electric cord can damage or break it, creating the risk of fire and electric shock. Always make sure you observe the following precautions.

- Never place heavy objects on the cord or subject it to heat. 
- Never try to modify the cord or subject it to excessive bending.
- Never twist or stretch the cord.
- Should the electric cord or plug become damaged, contact your original retailer or authorized CASIO Service Provider. 

● Never touch the AC adaptor while your hands are wet. Doing so creates the risk of electric shock. 

● Use the AC adaptor where it will not be splashed with water. Water creates the risk of fire and electric shock. 

● Do not place a vase or any other container filled with liquid on top of the AC adaptor. Water creates the risk of fire and electric shock. 

Batteries

Misuse of batteries can cause them to leak, resulting in damage to nearby objects, or to explode, creating the risk of fire and personal injury. Always make sure you observe the following precautions.

- Never try to take batteries apart or allow them to become shorted. 
- Never expose batteries to heat or dispose of them by incineration.
- Never mix old batteries with new ones.
- Never mix batteries of different types.
- Do not charge the batteries.
- Make sure the positive (+) and negative (-) ends of the batteries are facing correctly.

Do not incinerate the product.

Never throw the product into fire. Doing so can cause it to explode, creating the risk of fire and personal injury.



Water and Foreign Matter

Water, other liquids, and foreign matter (such as pieces of metal, pencils, etc.) getting into the product create the risk of fire and electric shock. Take the following steps immediately.



1. Turn off power.
2. If you are using the AC adaptor for power, unplug it from the wall outlet.
3. Contact your original retailer or an authorized CASIO Service Provider.

Disassembly and Modification

Never try to take this product apart or modify it in any way. Doing so creates the risk of electric shock, burn injury, or other personal injury. Leave all internal inspection, adjustment, and maintenance up to your original retailer or authorized CASIO Service Provider.



Dropping and Impact

Continued use of this product after it has been damaged by dropping or subjecting it to strong impact creates the risk of fire and electric shock. Take the following steps immediately.

1. Turn off power.
2. If you are using the AC adaptor for power, unplug it from the wall outlet.
3. Contact your original retailer or an authorized CASIO Service Provider.



Plastic Bags

Never place the plastic bag the product comes in over your head or in your mouth. Doing so creates the risk of suffocation.



Particular care concerning this precaution is required where small children are present.

Keep off of the product and stand.*

Climbing onto the product or stand can cause it to tip over or become damaged. Particular care concerning this precaution is required where small children are present.



Location



Avoid locating the product on an unstable stand, on an uneven surface, or any other unstable location. An unstable location can cause the product to fall over, creating the risk of personal injury.



⚠ CAUTION

AC Adaptor

● Misuse of the AC adaptor creates the risk of fire and electric shock. Always make sure you observe the following precautions.

- Do not locate the electric cord near a stove or other sources of heat. 
- Never pull on the cord when unplugging from the electrical outlet. Always grasp the AC adaptor when unplugging.
- Insert the AC adaptor into the wall outlet as far as it will go. 
- Unplug the AC adaptor from the wall outlet during lightning storms or before leaving on a trip or other long-term absence.
- At least once a year, unplug the AC adaptor from the wall outlet and wipe away any dust that is built up in the area around the prongs of the plug.
- Never use detergent to clean the power cord, especially the plug and jack parts.

Relocating the Product

Before relocating the product, always unplug the AC adaptor from the wall outlet and disconnect all other cables and connecting cords. Leaving cords connected creates the risk of damage to the cords, fire, and electric shock. 

Cleaning

Before cleaning the product, always unplug the AC adaptor from the wall outlet first. Leaving the AC adaptor plugged in creates the risk of damage to the AC adaptor, fire, and electric shock. 

Batteries

Misuse of batteries can cause them to leak resulting in damage to nearby objects, or to explode, creating the risk of fire and personal injury. Always make sure you observe the following precautions.

- Use only batteries that are specified for use with this product. 
- Remove batteries from the product if you do not plan to use it for a long time.

Connectors

Connect only the specified devices and equipment to the product's connectors. Connection of a non-specified device or equipment creates the risk of fire and electric shock. 

Location

Avoid the following locations for this product. Such locations create the risk of fire and electric shock. 

- Areas subject to high humidity or large amounts of dust.
- In food preparation areas or other areas subject to oil smoke.
- Near air conditioning equipment, on a heated carpet, in areas exposed to direct sunlight, inside of a vehicle parked in the sun, or any other area that subjects the product to high temperatures.

Display Screen



- Never push on the display screen's LCD panel or subject it to strong impact. Doing so can cause the LCD panel's glass to crack, creating the risk of personal injury. 
- Should the LCD panel ever crack or break, never touch the liquid inside of the panel. LCD panel liquid can cause skin irritation.
- Should LCD panel liquid ever get inside your mouth, immediately wash out your mouth with water and contact your physician.
- Should LCD panel liquid ever get into your eyes or onto your skin, rinse with clear water for at least 15 minutes, and then contact a physician.

Sound Volume

Do not listen to music at very loud volumes for long periods. Particular care concerning this precaution is required when using headphones. High volume settings can damage your hearing. 

Health Precaution

In extremely rare cases, exposure to strong sudden light or flashing light can cause momentary muscle spasms, loss of consciousness, or other physical problems with some individuals.

- If you suspect that you might be susceptible to any condition such as this, be sure to consult with your physician before using this product. 
- Use this product in an area that is well illuminated. 
- Should you ever feel any symptoms similar to those described above when using this product, stop using it immediately and contact your physician. 

Heavy Objects

Never place heavy object on top of the product. 
Doing so can make the product top heavy, causing the product to tip over or the object to fall from it, creating the risk of personal injury.

Correct Stand* Assembly

An incorrectly assembled stand can tip over, causing the product to fall and creating the risk of personal injury. 
Make sure you assemble the stand correctly, following the assembly instructions that come with it. Make sure you mount the product on the stand correctly.

* Stand is available as an option.

IMPORTANT!

When using batteries, be sure to replace them or shift to one of the alternate power sources whenever you notice any of the following symptoms.

- Instrument does not turn on
- Display that is flickering, dim, or difficult to read
- Abnormally low speaker/headphone volume
- Distortion of sound output
- Occasional interruption of sound when playing at high volume
- Sudden power failure when playing at high volume
- Flickering or dimming of the display when playing at high volume
- Continued sound output even after you release a key
- A tone that is totally different from the one that is selected
- Abnormal rhythm pattern and Song Bank play



Main Features

On-screen fingering and timing indicators

- Easy-to-understand on-screen indicators help to simplify keyboard play, even for novices.

100 amazingly realistic tones

Enhanced auto-accompaniment function for greater versatility

- 50 built in auto-accompaniment patterns.

100 Built-in Song Bank tunes

- A total of 100 built-in Song Bank tunes comes built in for playback enjoyment or play-along practice.

3-Step Lesson System

- Develop your musical skills by following the keys as they light. First you become familiar with the timing of the notes by watching the keys light as you playback one of the 100 built-in Song Bank tunes. Next, practice playing along at a pace that's comfortable for you. Finally, try playing along at the normal tempo for the Song Bank tune.
- A simulated human voice is used during Step 1 or Step 2 play to call out the fingers you should use to play the required notes (Voice Fingering). The timing of notes is also indicated on the display screen.

Auto Accompaniment

- Simply specify a chord and the keyboard automatically produces the matching rhythm, bass, and chord patterns. One-touch fill-ins make accompaniments sound interesting and natural.

Transpose Function

- An easy operation instantly changes the key of the keyboard.

Contents

Safety Precautions E-1

Main Features E-6

General Guide E-8

Attachment of Score Stand E-9

Quick Reference E-10

Power Supply E-11

Using a Household Power Outlet E-11

Using Batteries E-11

Auto Power Off E-12

Settings E-12

Connections E-13

Phones/Output Jack E-13

Accessories and Options E-13

Basic Operations E-14

To switch power on and off E-14

To change tones E-14

Other Useful Functions E-15

Playing the demo tunes E-16

Playing rhythms E-17

Using auto-accompaniment E-17

Improvising with the preset patterns E-19

3-Step Lesson System E-20

Using 3-Step Lesson System E-20

Voice Fingering Guide E-22

Timing Indicator E-22

Step 1: Master the timing E-23

Step 2: Master the melody E-24

Step 3: Play at normal speed E-24

To practice the left hand part E-25

Technical Reference E-26

Troubleshooting E-26

Specifications E-28

Operating Precautions E-29

Appendix A-1

Tone List A-1

Rhythm List A-2

Fingered Chord Charts A-3

Song List A-5

General Guide

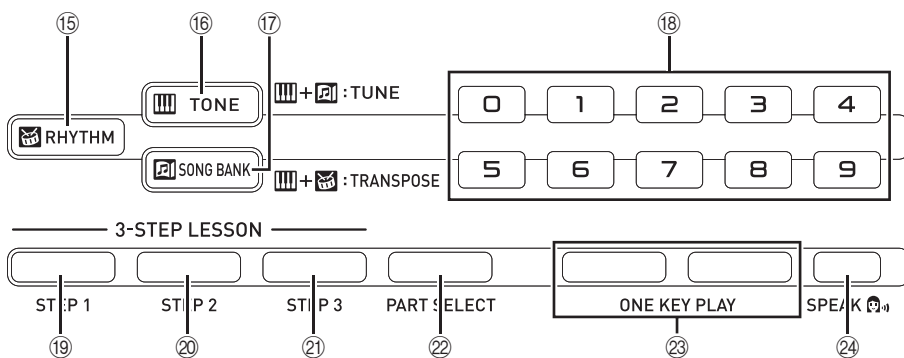
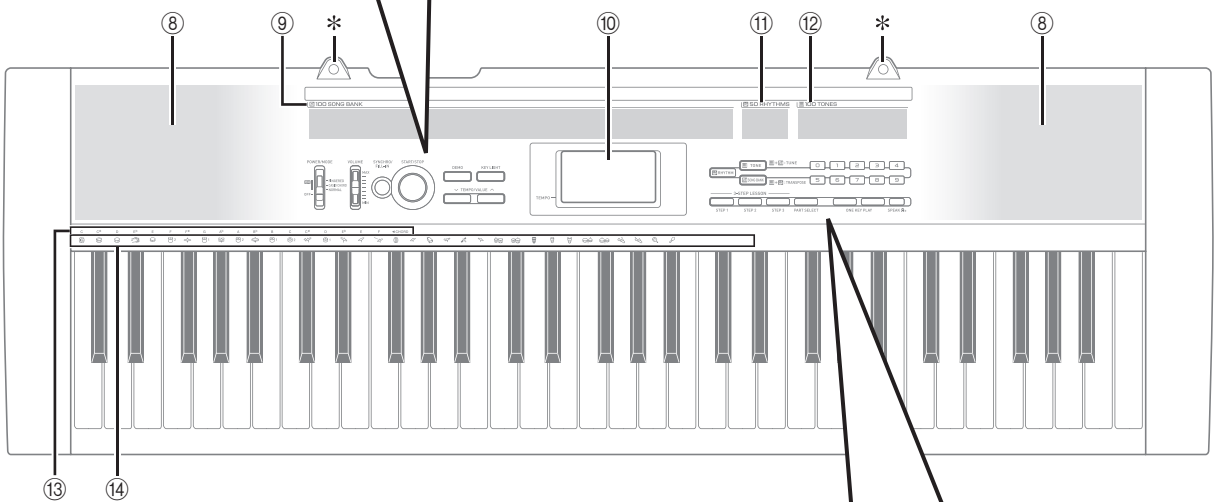
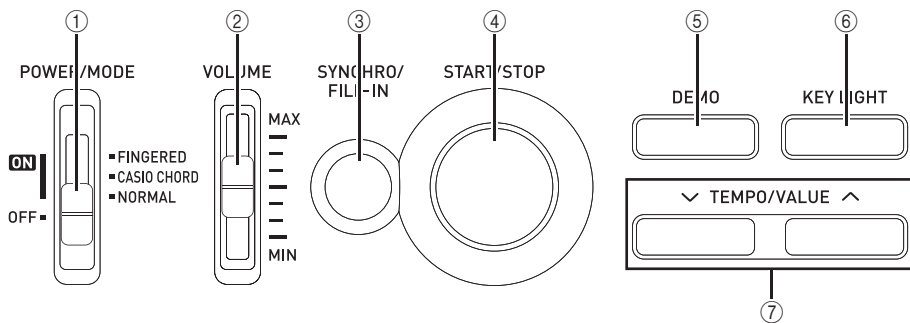

- ① POWER/MODE selector
- ② VOLUME slider
- ③ SYNCHRO/FILL-IN button
- ④ START/STOP button
- ⑤ DEMO button
- ⑥ KEY LIGHT button
- ⑦ TEMPO/VALUE buttons
- ⑧ Speakers
- ⑨ 100 SONG BANK list
- ⑩ Display
- ⑪ 50 RHYTHMS list
- ⑫ 100 TONES list
- ⑬ CHORD root names
- ⑭ Percussion instrument list

- ⑮ RHYTHM button
- ⑯ TONE button
- ⑰ SONG BANK button
- ⑱ Number buttons

● **3-STEP LESSON**

- ⑲ STEP 1 button
- ⑳ STEP 2 button
- ㉑ STEP 3 button
- ㉒ PART SELECT button
- ㉓ ONE KEY PLAY buttons
- ㉔ SPEAK button

Rear Panel

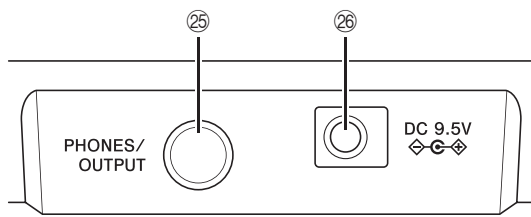

⑲ **PHONES/OUTPUT jack**

For connection of commercially available headphones. Output from the speakers is automatically cut when headphones are connected.

⑳ **DC 9.5V jack**

*** Attachment of Score Stand**

Insert both ends of the music stand provided with the keyboard into the two holes on the top surface.

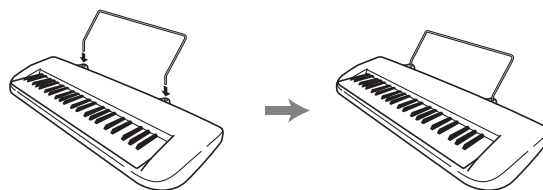

Quick Reference

This section provides a quick overview of keyboard operation using steps one and two of the 3-step lesson feature. See page E-20 for detailed explanations of these steps.

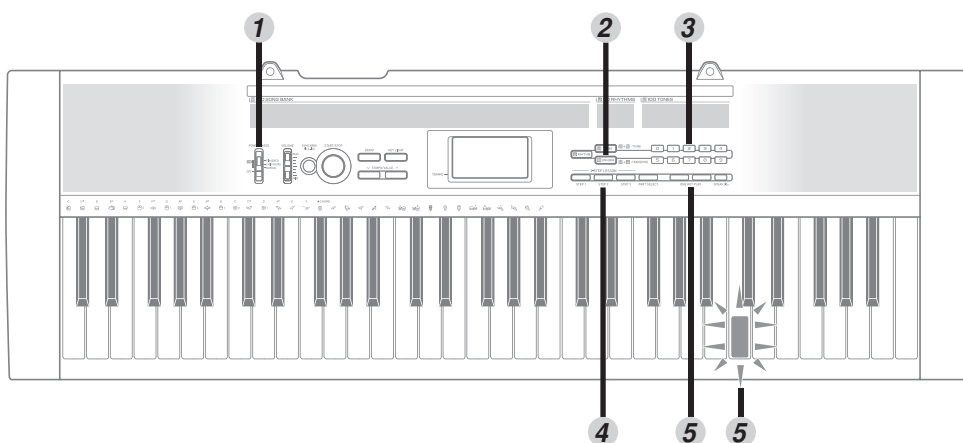

- 1 Set the POWER/MODE selector to NORMAL.

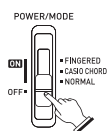

- 2 Press the SONG BANK button.



- 3 Find the tune you want to play in the Song Bank list, and then use the number buttons to input its two-digit number.

- To select "13 TWINKLE TWINKLE LITTLE STAR", input 1 and then 3.



- Not all of the available songs are shown on the song bank list printed on the keyboard console. For a complete list, see the "Song List" on page A-5.

- 4 Press the STEP 1 button or STEP 2 button.

- When you do, the STEP 1 indicator or STEP 2 indicator appears.
- The keyboard sounds a count beat and waits for you to play something on the keyboard. The keys that you need to press first flash.
- Play in accordance with the fingerings that appear on the display.

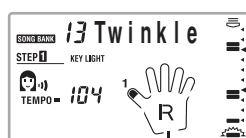

Fingering

- 5 Play the melody part on the keyboard.

<If you pressed the STEP 1 button in 4 ...>

Play the notes with the ONE KEY PLAY buttons.

- The accompaniment tempo automatically adjusts to play along with your melody.



Play the notes on the keyboard.

- A sub-melody (obligato) plays in time with the melody.
- With Step 1, the correct melody note is played no matter which keyboard key you press.

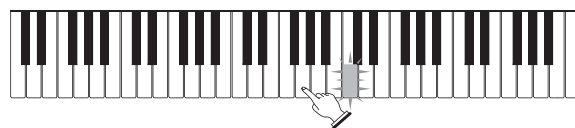

<If you pressed the STEP 2 button in 4 ...>

Play the notes on the keyboard, pressing keys as they light.

- Keep the key depressed as long as it stays lit.
- If you selected any song from number 84 through 99, the lit key goes out as soon as you press it.
- The key that corresponds to the next note you need to play will flash.
- After you press the correct melody key, accompaniment proceeds to the next note.



Power Supply

Prepare a household power outlet or batteries.

IMPORTANT!

- Be sure to comply with the "Safety Precautions" provided in this manual. Incorrect use of this product creates the risk of electric shock and fire.
- Always make sure that the Digital Keyboard is turned off before plugging in or unplugging the AC adaptor, or before loading or removing batteries.

Using a Household Power Outlet

Make sure that you use only the AC adaptor specified for this keyboard. Use of a different type of AC adaptor can cause malfunction.

Specified AC Adaptor: AD-E95100L (JEITA Standard plug)

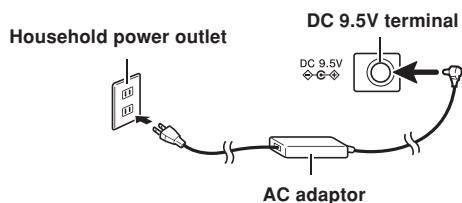

IMPORTANT!

- The AC adaptor will become warm to the touch after very long use. This is normal and does not indicate malfunction.
- To prevent breaking of the wire, take care to avoid putting any type of load on the power cord.

No bending!



No winding!

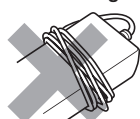

- Never insert metal, pencils, or any other objects into the product's 9.5V DC terminal. Doing so creates the risk of accident.

Using Batteries

You can use six AA-size batteries for power.

- Use alkaline or zinc-carbon batteries. Never use oxyride or any other nickel based batteries.

Open the battery cover on the bottom of the Digital Keyboard, load the batteries, and then close the cover.

- Take care to ensure that the positive (+) and negative (-) ends of the batteries are facing correctly.

1. Remove the battery compartment cover.

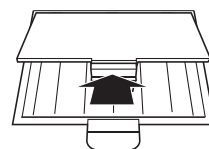

2. Load 6 AA-size batteries into the battery compartment.

- Make sure that the positive (+) and negative (-) ends are facing correctly.

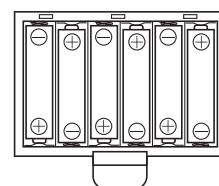

3. Insert the tabs on the battery compartment cover into the holes provided and close the cover.

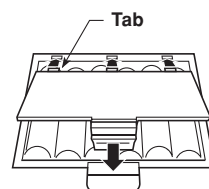

Important Battery Information

- The following shows the approximate battery life.

Alkaline batteries 4 hours

Zinc-carbon batteries 1 hour

The above value is standard battery life at normal temperature, with the keyboard volume at medium setting. Temperature extremes or playing at very loud volume settings can shorten battery life.

- Any of the following symptoms indicate low battery power. Replace batteries as soon as possible whenever any of the following occurs.

- Instrument does not turn on
- Display that is flickering, dim, or difficult to read
- Abnormally low speaker/headphone volume
- Distortion of sound output
- Occasional interruption of sound when playing at high volume
- Sudden power failure when playing at high volume
- Flickering or dimming of the display when playing at high volume
- Continued sound output even after you release a key
- A tone that is totally different from the one that is selected
- Abnormal rhythm pattern and Song Bank play

Auto Power Off

The Digital Keyboard will turn off automatically to preserve power if you do not perform any operation for about six minutes.

To disable Auto Power Off

Hold down the TONE button while turning on the keyboard to disable Auto Power Off.

■ NOTE

- When Auto Power Off is disabled, the keyboard does not turn off automatically no matter how long it is left with no operation being performed.
- Auto Power Off is automatically enabled whenever you turn on keyboard power.

Settings

All keyboard settings are returned to their initial defaults whenever keyboard power is turned back on after being turned off by operation of the POWER/MODE selector or Auto Power Off.

Connections

Phones/Output Jack

Before connecting headphones or other external equipment, be sure to first turn down the volume settings of the keyboard and the connected equipment. You can then adjust volume to the desired level after connections are complete.

[Rear Panel]

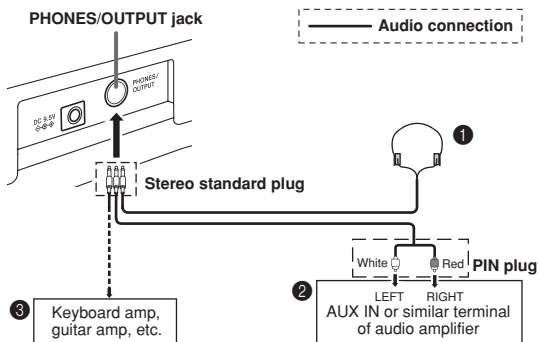

Connecting Headphones (Figure 1)

Connecting headphones cuts off output from the keyboard's built-in speakers, so you can play even late at night without disturbing anyone.

Audio Equipment (Figure 2)

Connect the keyboard to an audio equipment using a commercially available connecting cord with a standard plug on one end and two PIN plugs on the other end. In this configuration, you normally set the input selector of the audio equipment to the terminal (usually marked AUX IN or something similar) where the cord from the keyboard is connected. See the user documentation that comes with your audio equipment for full details.

Musical Instrument Amplifier (Figure 3)

Use a commercially available connecting cord to connect the keyboard to a musical instrument amplifier.

NOTE

- Be sure to use a connecting cord that has standard plugs on the ends you connect to the keyboard and amplifier.

[Connection Example]

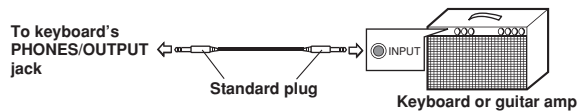

Accessories and Options

Use only the accessories and options specified for this keyboard. Use of non-authorized items creates the danger of fire, electrical shock, and personal injury.

- You can get information about accessories that are sold separately for this product from the CASIO catalog available from your retailer, and from the CASIO website at the following URL.

<http://world.casio.com/>

Basic Operations

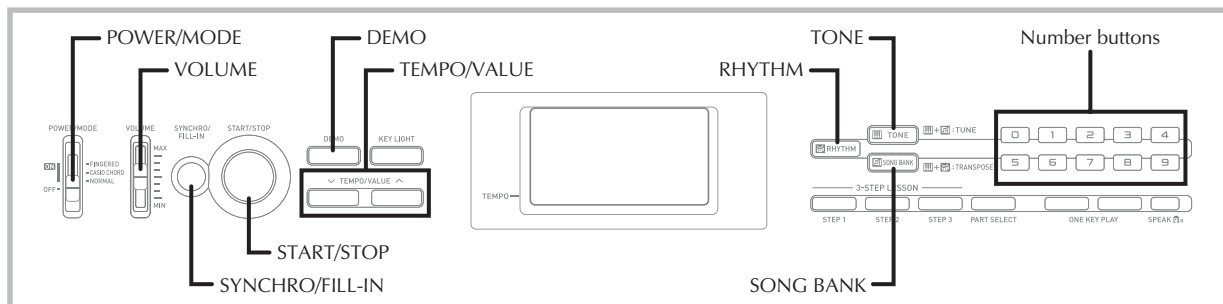

This part of the manual provides you with the basic information you need to use your keyboard.

To switch power on and off

1. Set the POWER/MODE selector to NORMAL.
2. Press the keyboard keys.
3. Use the VOLUME slider to set the volume to a relatively low level.
4. To switch power off, set the POWER/MODE selector to OFF position.

To change tones

1. Find the tone you want to use in the “Tone List” (page A-1) and note its tone number.

2. Press the TONE button.

Indicator appears



3. Use the number buttons to input the 2-digit number that identifies the tone you want to select.

Example: To select “26 ACOUSTIC BASS”, input 2 and then 6.



NOTE

- Always enter two digits for the tone number. If you enter only one digit, the display will automatically return to the previous tone number setting after a few seconds.
- If you change the tone setting while a keyboard key is depressed, the tone does not change until you release the key and press a keyboard key again.
- With certain tones (such as percussion sounds and sound effects), there may be very little or no change at all in the pitch, no matter which keyboard key you press.
- If you input the wrong first digit for a tone number, you can return to the previous setting by pressing the TONE button.

Keyboard split tones

Some of the preset tones split the keyboard and assign two or more sounds. With such a preset tone, the sound produced depends on what position of the keyboard you play. For example, BASS/PIANO (tone 90) puts BASS on the left and PIANO on the right of the keyboard.

<Example>

BASS/PIANO (No.90)

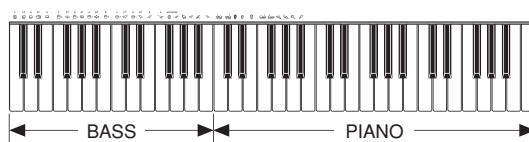

PERCUSSION (No.99)

- PERCUSSION (Tone 99) assigns 35 percussion sounds to the keyboard as shown below. The sounds assigned to each key are indicated above the keyboard.



	BASS DRUM		RIDE BELL
	SIDE STICK		TAMBOURINE
	ACOUSTIC SNARE		SPLASH CYMBAL
	HAND CLAP		COWBELL
	ELECTRIC SNARE		CRASH CYMBAL 2
	LOW TOM 2		CLAVES
	CLOSED HI-HAT		RIDE CYMBAL 2
	LOW TOM 1		HIGH BONGO
	PEDAL HI-HAT		LOW BONGO
	MID TOM 2		MUTE HIGH CONGA
	OPEN HI-HAT		OPEN HIGH CONGA
	MID TOM 1		LOW CONGA
	HIGH TOM 2		HIGH TIMBALE
	CRASH CYMBAL 1		LOW TIMBALE
	HIGH TOM 1		HIGH AGOGO
	RIDE CYMBAL 1		LOW AGOGO
	CHINESE CYMBAL		CABASA
			MARACAS

Polyphony

The term polyphony refers to the maximum number of notes you can play at the same time. This keyboard has 12-note polyphony, which includes the notes you play as well as the rhythms and auto-accompaniment patterns that are played by the keyboard. This means that when a rhythm or auto-accompaniment pattern is being played by the keyboard, the number of notes (polyphony) available for keyboard play is reduced. Also note that some of the tones offer only 6-note polyphony.

- When rhythm or auto accompaniment is playing, the number of sounds simultaneously played is reduced.
- Though you can sound up to 12 notes at one time, only the last four keyboard keys pressed light up.

Other Useful Functions

To change the key of the keyboard

The transpose feature of this keyboard lets you raise or lower its key in semitone increments. This means you can easily match to suit someone's voice, and you can eliminate sharps and flats from music making it easier to play.

1. While in any mode besides the Song Bank Mode (indicated when the SONG BANK indicator is lit), hold down the TONE button and press the RHYTHM button.

- Perform step 2 within five seconds after performing step 1.

Trans

2. Use the TEMPO/VALUE buttons to change the key of the keyboard.

Example: To change the tuning to B (indicated by -1 since it is one tone below C, which is the normal tuning of the keyboard).

Trans (-)

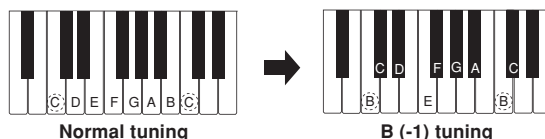

<Keys and their indicators>

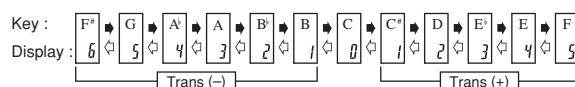

- ◆ : Pressing ▲
- ◊ : Pressing ▼

<Note Names>



NOTE

- If you leave the transpose screen on the display for about five seconds without doing anything, the screen is automatically cleared.
- You cannot change the transpose setting while the keyboard is in the Song Bank Mode.
- In step 2 of the above operation, you could also use the number buttons 0 to 5 to specify C through F.
- Pressing both of the TEMPO/VALUE buttons (∧/∨) at the same time returns the transpose setting to C(0).
- The transpose setting is automatically set to C(0) whenever you turn keyboard power on.
- The transpose setting is automatically set to C(0) whenever you press the SONG BANK button.
- The pitch of a transposed note depends on the tone you are using. If the transpose operation causes a note to exceed the range of the tone you are using, the same note in the highest octave of the tone's range is substituted.
- The transpose operation does not affect tone number 99 (PERCUSSION) or auto-accompaniment rhythms.
- Transposing tones 75 through 79 and 90 through 96 changes the range of keys to which each of the tones is assigned.
- The transpose setting is automatically set to C(0) whenever you press the DEMO button.

To tune the keyboard

A simple operation lets you tune the keyboard to another musical instrument.

1. While in any mode besides the Song Bank Mode (indicated when the SONG BANK indicator is lit), hold down the TONE button and press the SONG BANK button.
 - Perform step 2 within five seconds after performing step 1.



00 Tune

2. Use the TEMPO/VALUE buttons to change the tuning of the keyboard.

Example: To lower tuning by 20



20 Tune (-)

NOTE

- If you leave the tuning screen on the display for about five seconds without doing anything, the screen is automatically cleared.
- In step 2 of the above procedure, you could also use the number buttons to input a value from 00 to 50.
- Pressing both of the TEMPO/VALUE buttons (∧/∨) at the same time returns the tuning setting to 00.
- Pressing the SONG BANK button changes the tuning setting to 00.
- The tuning setting does not affect any of Song Bank tunes.
- You can tune the keyboard within a range of approximately ±50 cents (100 cents = 1 semitone).
- The tuning setting is automatically set to 00 whenever you turn the keyboard on.
- Pressing the DEMO button changes the tuning setting to 00.
- The tuning operation does not affect rhythm (99 PERCUSSION).

Playing the demo tunes

You can set up the keyboard to continually play its 100 built-in Song Bank tunes.

Keyboard keys light to indicate the melody notes of the demo tune as it plays.

To start demo tune play

1. Switch power on and adjust the volume level.
2. Press the DEMO button.
 - Demo tune play continues in a sequential endless loop until you switch it off.
 - The number and name of the demo tune currently playing are shown on the display.
 - You can play along on the keyboard while a demo tune is playing back.
3. You can change the demo tune play being played by pressing the number buttons.
 - The Song Bank tunes play back in tune number sequence, starting from the one you select.

To stop demo tune play

Press the DEMO button or START/STOP button again to stop demo tune play.

NOTE

- Only the following buttons are enabled while a Song Bank tune is being played.
 - VOLUME slider
 - Number buttons
 - START/STOP button
 - POWER/MODE selector (OFF)
 - DEMO button
 - KEY LIGHT button
 - SPEAK button
- You cannot change the tone being used for the melody of a Song Bank tune.

Playing rhythms

This keyboard features a collection of 50 exciting built-in rhythm patterns. Each pattern provides percussion back up for all your performances.

To select and play a rhythm

1. Set the POWER/MODE selector to NORMAL.
2. Find the rhythm you want to use in the “Rhythm List” (page A-2) and note its rhythm number.
3. Press the RHYTHM button.
 - When you do, the RHYTHM indicator appears.
 - The number and name that appear on the display indicate the currently selected rhythm.
4. Use the number buttons to input the 2-digit rhythm number for the rhythm you want to use.
Example: To select “37 SAMBA”, input 3 and then 7.

RHYTHM 37 Samba

5. Press the START/STOP button to start play of the rhythm.
 - When you do, the selected rhythm starts to sound.

6. Use the TEMPO/VALUE buttons to adjust the tempo of the rhythm.

TEMPO = 120

- Each time you press one of the TEMPO/VALUE buttons while the tempo value is displayed, the tempo setting changes one step, within the range of 040 to 255.
- The initial default tempo setting when you turn on power is 120.
- After displaying the current tempo setting by pressing the TEMPO/VALUE button in step 6, you can also input the tempo setting you want by inputting a three-digit value with the number buttons.
- Holding down either of the TEMPO/VALUE buttons changes the tempo setting at high speed.
- To reset the tempo to the standard value of each rhythm, press both TEMPO/VALUE buttons.

7. To stop rhythm play, press the START/STOP button again.

Using auto-accompaniment

This keyboard features 50 accompaniment patterns that let you add full accompaniments to your performances automatically. With auto-accompaniment, part of the keyboard is reserved as an accompaniment keyboard. As you play your chords on the accompaniment keyboard, the accompaniment pattern adjusts automatically to follow the progression you play.

You get a choice between two different methods for chord play. FINGERED lets you play chords as you normally do, while CASIO CHORD makes it possible to play fully formed chords with one finger.

About the accompaniment keyboard

The lower (left) 1.5 octaves are reserved for use as an accompaniment keyboard whenever you select CASIO CHORD or FINGERED with the POWER/MODE selector. The panel above the accompaniment keyboard keys is marked with the names of the notes they play. The remainder of the keyboard (the part that is not included in the accompaniment keyboard) is called the melody keyboard. Please be sure to remember these terms, because they will be used throughout the rest of this manual.

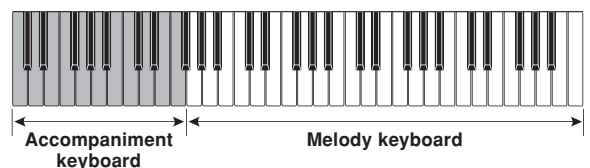

(The entire keyboard can be used for melody play while the POWER/MODE selector is set to NORMAL.)

Using the CASIO CHORD system

The CASIO CHORD system lets you easily play the four main types of chords. Play of chords is simplified as shown in the chart below.

Keys	Type	Example
Pressing one accompaniment key	Major chord	C (C Major Chord)
Pressing two accompaniment keys	Minor chord	Cm (C Minor Chord)
Pressing three accompaniment keys	Seventh chord	C7 (C Seventh Chord)
Pressing four accompaniment keys	Minor seventh chord	Cm7 (C Minor Seventh Chord)

NOTE

- The bottom (leftmost) note that you play determines the name of the chord. If the bottom note is a C for example, the keyboard produces a C chord.
- When pressing more than one accompaniment key, it makes no difference whether the keys to the right of the bottom note are white or black.

To play a CASIO CHORD auto-accompaniment

- Use the POWER/MODE selector to select CASIO CHORD.
- Select an auto-rhythm as described under "To select and play a rhythm" on page E-17.
- Start play of the rhythm.
 - If you want to start play of the normal rhythm pattern, press START/STOP.
 - You can also use synchro start (page E-19) to start rhythm play.
- Press either one or up to four keys on the accompaniment keyboard, and the corresponding accompaniment starts to play automatically.



- Continue pressing different keys on the accompaniment keyboard to play your chord progression.

- To stop auto-accompaniment play, press the START/STOP button again.

Using standard fingerings

The FINGERED mode lets you play a wider variety of chords. In this mode, you can start play of an accompaniment pattern by pressing three or four of the accompaniment keyboard keys.

This keyboard is capable of recognizing 15 different chords. The following shows the fingerings of these chords with a root of C. Note that you can omit the fifth notes (which are shown inside parentheses in the illustrations below) to produce 7, m7, M7, add9, madd9, and mM7 chords.

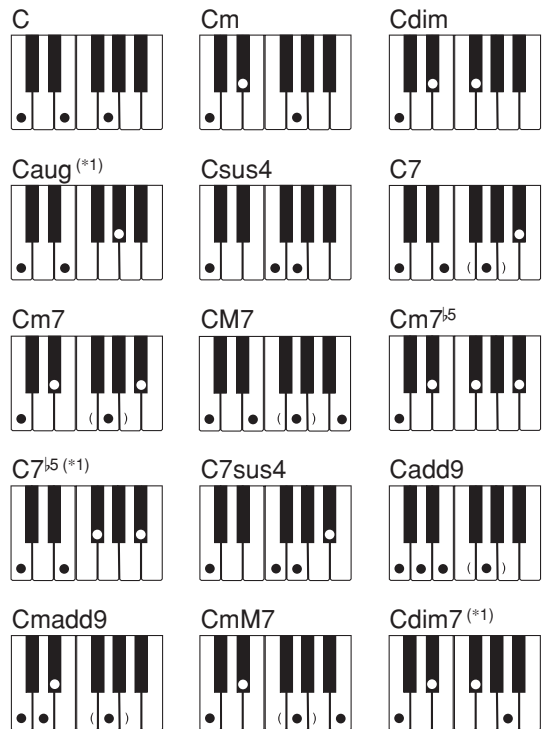

- *1 With this chords, the lowest note in your fingering is always used as the root. Make sure that your fingering correctly identifies the root you want to use.

IMPORTANT!

- If you play one or two notes only in the left hand, or three notes that do not make up a recognizable chord formation, no sound will be produced. The FINGERED mode requires a conventional three or four-note chord formation to produce an auto-accompaniment. Also, note that auto-chords only work in conjunction with rhythm patterns, and not independently of them.

NOTE

- The above examples show only one of the possible fingerings for each chord. Note that you can play the notes that form a chord in any combination. Each of the following fingerings for example, produces the same C chord.

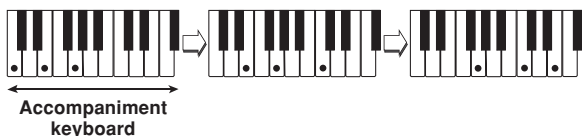

- See the “Fingered Chord Charts” on page A-3 for information on the fingerings of chords for all roots.

To play a FINGERED auto-accompaniment

1. Use the POWER/MODE selector to select FINGERED.
2. Select an auto-rhythm as described under “To select and play a rhythm” on page E-17.
3. Start play of the rhythm.
 - If you want to start play of the normal rhythm pattern, press START/STOP.
 - You can also use synchro start (on this page) to start rhythm play.
4. Play a chord on the accompaniment keyboard to start play of the auto-accompaniment.

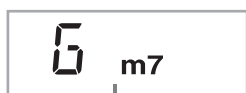

Chord name

5. Continue pressing keys on the accompaniment keyboard to play your chord progression.
6. To stop auto-accompaniment play, press the START/STOP button again.

Improvising with the preset patterns

Pressing the START/STOP button to start rhythm play causes the normal version of the pattern to be played. You can also play a variation of the rhythm using the operation described below.

Using fill-in rhythm

You can insert a fill-in rhythm by pressing the SYNCHRO/FILL-IN button while an auto-rhythm plays.

Using Synchro start

You can start the rhythm and accompaniment pattern at the same time, with your play of the accompaniment keyboard. To do this, follow the steps below.

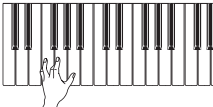
1. Set the POWER/MODE selector to the CASIO CHORD or FINGERED position.
 2. Select an auto-rhythm.
 3. Press the SYNCHRO/FILL-IN button.
 4. Press the accompaniment keys to play the first chord. As soon as you do, the auto-accompaniment pattern begins to play.
- 
5. To stop the auto-accompaniment pattern play, press the START/STOP button.

NOTE

- If you set the POWER/MODE selector to NORMAL in step 1 on page E-17, the operation in step 4 starts play of the rhythm (percussion instruments) only.

3-Step Lesson System

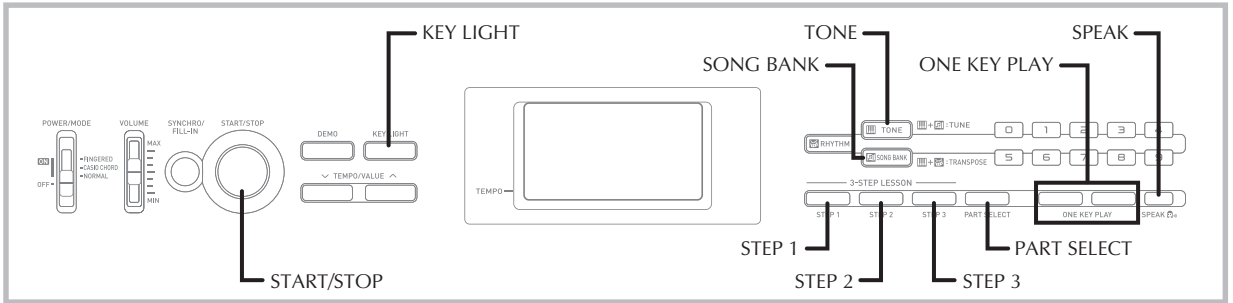

Using 3-Step Lesson System

Even individuals who cannot play the keyboard at all can follow along with the 100 built-in Song Bank tunes with the ONE KEY PLAY buttons. You can also use the 3-Step Lesson System to learn at your own pace. Play slowly at first until you are able to play along at normal speed.

Of the 100 built-in tunes, numbers 00 through 83 feature auto-accompaniment (auto-accompaniment tunes), while 84 through 99 are played using both hands (two-hand tunes).

The 3-Step Lesson System can be used with the following 3-step lesson plan to master keyboard play.

Step 1: Master the timing

Pressing the ONE KEY PLAY buttons plays the melody for an auto-accompaniment tune or the right hand part for two-hand tunes. In both cases, the auto-accompaniment (the left hand part in the case of two-hand tunes) is played automatically by the keyboard. In place of the ONE KEY PLAY buttons, you can also press any key of the keyboard to play the melody or right hand part. The purpose of this step is to familiarize yourself with the timing required to play melody notes.

Step 2: Master the melody

In this step, you use the display to learn which fingers you should use to play, and the key light system to learn which keyboard keys to press. You can play at the pace you want, because the auto-accompaniment or left hand part waits until you press the correct key.

Step 3: Play at normal speed

At this level, the keyboard's keys still light to indicate which notes to play, but they no longer wait for you to press the correct key. The auto-accompaniment or left hand part is played at normal speed.

NOTE

- You may not be able to see the keyboard keys light under direct sunlight or in other brightly lit areas.

3-Step Lesson System Tempo Setting

You can use the procedure in step 6 of the procedure on page E-18 to set the tempo of the left-hand part for Song Bank and 3-Step Lesson System play (Step 1 through 3).

This means you can use a slower tempo at the beginning, and then increase it as you learn. Press both of the TEMPO/VALUE buttons (▲ and ▼) at the same time to return the tempo to its initial preset setting.

To play a built-in Song Bank tune

- Look up the number of the tune you want to play in the Song Bank list.
 - Not all of the available songs are shown on the song bank list printed on the keyboard console. For a complete list, see the "Song List" on page A-5.
- Press the SONG BANK button until the SONG BANK indicator appears.
 - This causes the number and name of the currently selected Song Bank tune to appear on the display.
- Input the two digit number for the tune you want to play.

Example: To select "13 TWINKLE TWINKLE LITTLE STAR", input 1 and then 3.



- Press the START/STOP button to start play of the selected tune.
 - The tune you select plays repeatedly, with the keyboard keys lighting to indicate the melody notes.

5. To stop Song Bank tune play, press the START/STOP button again.
6. To exit the Song Bank Mode, press the SONG BANK button again.
 - When you do, the SONG BANK indicator goes out.

NOTE

- Always enter two digits for the Song Bank number.
- You can input a Song Bank tune number even while another Song Bank tune is playing.
- If you input the wrong first digit for a Song Bank tune number, you can return to the previous setting by pressing the SONG BANK button.
- The RHYTHM button is disabled in the Song Bank Mode. If you want to play a rhythm, press the SONG BANK button to return to the normal mode first.

Key Lighting System Operation and Display Contents During Song Bank Play

Keyboard keys light to show the keys that should be pressed to play along with Song Bank tunes as they play back. At the same time, the display shows fingerings, chord names, tempo and other information.

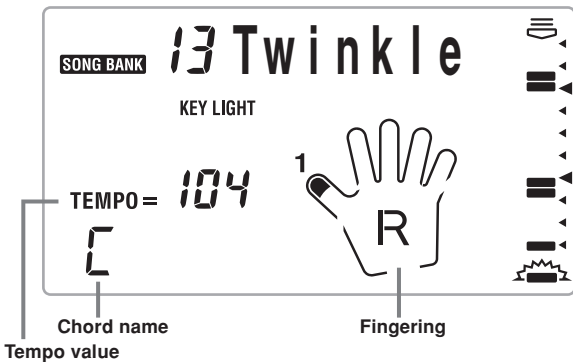

Crossed Finger Indications

The display also shows when you have to cross fingers to play notes, and in which direction your fingers should cross.

Example: Display for playing the notes below with the right hand

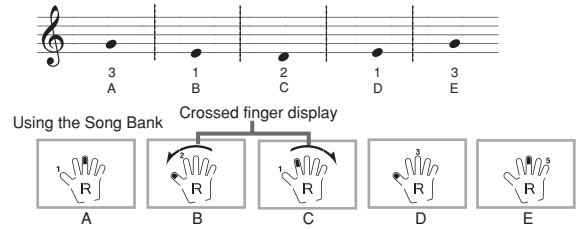

- B and C indicate that the index finger should cross over the thumb.
- C and D indicate that the thumb should cross under the index finger.

Key Lighting During Song Bank Play

When you play back a Song Bank tune, keyboard keys light to show you the notes that are being played.

Auto-accompaniment Song Bank Tune

Chord and melody part keys light.

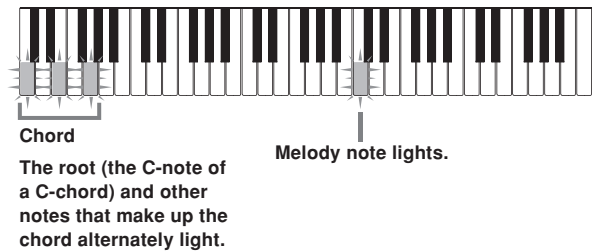

NOTE

- Some Song Bank tunes use chords (such as C6) that cannot be played with the FINGERED setting (page E-18). In the FINGERED mode, chords may sound different from the ones produced by Song Bank tune playback, even if you finger the chords as indicated by the lit keys.

Two-hand Song Bank Tune

Left hand and right hand part keys light.

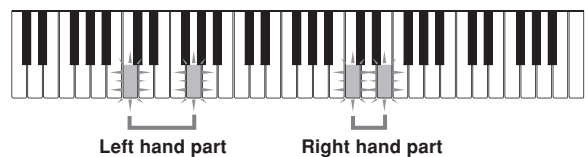

Key Lighting System Operation and Display Contents During 3-step Lesson Play

Whenever you select an Auto Accompaniment tune (00 to 83) for 3-step lesson play, the key lighting system shows you which keys to press, while the display shows you the fingerings.

Note Pitch

The keyboard key that should be pressed lights. The fingers you should use to play the notes are also shown on the display.

Note Length

Keyboard keys stay lit for as long as the note should be played. The fingerings also remain on the display for the length of the note.

Next Note

The keyboard key for the next note to be played flashes, while a number appears on the display near the finger you should use to play the next note.

Series of Same Pitch Notes

The keyboard key light turns off momentarily between the notes and lights again for each successive note. The fingerings also turn off and back on again.

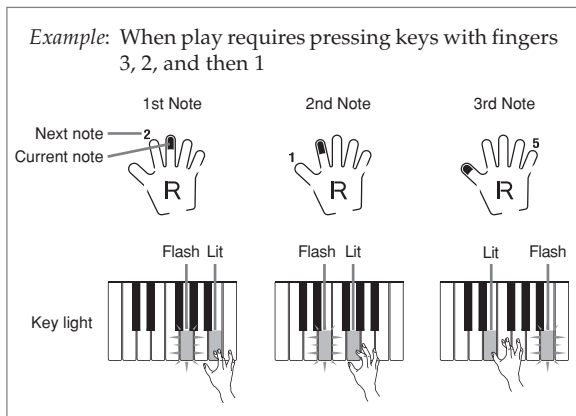

NOTE

- Note length is not indicated when you are using two-hand tunes (84 to 99) with 3-Step Lesson Steps 1 and 2. As soon as you press a lit key, it goes out and the next key to be played starts to flash.
- Note length is indicated by the key light system when you use a two-hand tune with Step 3. In this case, the next key to be pressed does not flash when you press a lit key and the next finger number does not appear on the display. Only the current finger number is shown.

Voice Fingering Guide

Voice fingering guide uses a simulated human voice to call out fingering numbers during Step 1 and Step 2 one-hand part practice. If you need to press a key with your thumb, for example, voice fingering guide says, "One!" In the case of a chord to be played with your thumb, middle and little finger, voice fingering guide says, "One, three, five!"

Voice Fingering Guide calls out fingerings only when you do not press the proper key when you should.

To turn voice fingering guide on and off

Use the SPEAK button to turn voice fingering guide on and off.



Voice fingering guide indicator

Timing Indicator

The timing indicator helps you become familiar with tunes you are playing for the first time by indicating the timing of notes you play on the keyboard. Timing is easier to see when you use a slow tempo during lesson play.

Using the Timing Indicator

The timing indicator shows the timing of notes contained in the currently selected part (R or L). Notes are indicated as two-segment blocks that scroll from the top of the display, down to the bottom. A note is played when its block reaches the bottom of the display.

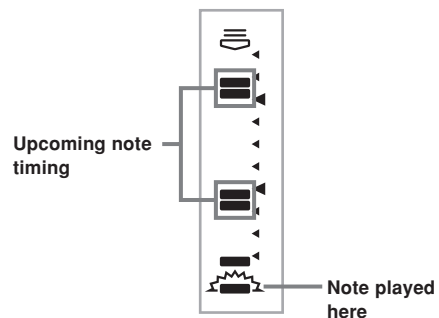

- Each two-segment block can indicate one or more notes, depending on the tune you are playing.

NOTE

- The Timing Indicator shows note timing whenever you play back a Song Bank tune and during a 3-Step Lesson.
- Note that the Timing Indicator shows approximate timing only.

Turning Off Key Lighting

1. Press the KEY LIGHT button.
 - The KEY LIGHT indicator disappears when the key light system is turned off.
 - Press the KEY LIGHT button again to turn key lighting back on.

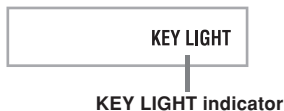

NOTE

Key lighting turns on automatically in any of the following cases:

- When keyboard power is turned on.
- When the SONG BANK button is pressed in the normal mode (page E-20).

Number of Simultaneously Lit Keys

Up to four keyboard keys can be lit at the same time.

To change the tone used for the melody of a Song Bank tune

1. Following step 3 of the procedure on page E-20, press the TONE button.
 - Both the SONG BANK indicator and TONE indicator appear, along with the tone number and name of the tone that is currently assigned to the keyboard.
2. Input a value to select the tone you want to use.

NOTE

- Selecting another Song Bank tune switches the tone setting to the newly selected tune's preset melody tone.
- The tone assigned to the keyboard is the same one specified for the melody of the Song Bank tune.
- The above procedure can be used to change the Song Bank melody tone before starting play or while play is already in progress.
- You can also change the tone of two-hand tunes (tune numbers 84 to 99). Note however, that selecting a sustainable tone (like an organ tone) when using 3-Step Lesson Step 1 or Step 2 (in which accompaniment waits for correct input from you before proceeding), can cause notes of the auto accompaniment to be sustained while the keyboard is waiting for your input. If this happens, play something on the keyboard to stop the sustained note.

Step 1: Master the timing

1. Press the STEP 1 button.
 - When you do, the STEP 1 indicator appears.
 - After a count sounds, the keyboard stands by and waits for you to play the first note of the tune. If the tune includes intro measures, the keyboard enters standby after the intro measures are complete.

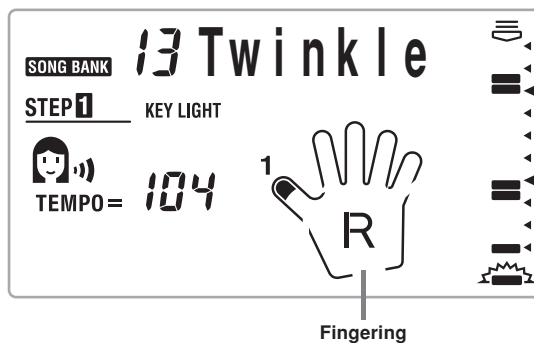

2. Press the ONE KEY PLAY buttons to play each note of the tune.
 - The accompaniment (left hand) part of the tune follows along as you play the melody (right hand) part.
 - The keyboard key that corresponds to the next note to be played flashes, and lights when you play the note.
 - The rhythm (percussion) part does not sound.
3. Try pressing any one of the keyboard keys in place of the ONE KEY PLAY buttons.
 - Pressing any keyboard key plays the correct melody (right hand part) note.
 - Pressing more than one key at the same time counts as a single melody note. Pressing a key while another key is held down is counted as two melody notes.



The correct note is played even if you do not press the key that is lit.

4. To stop play at any time, press the START/STOP button.
 - When you do, the STEP 1 indicator goes out.

Step 2: Master the melody

1. Press the STEP 2 button.
 - When you do, the STEP 2 indicator appears.
 - After a count sounds, the keyboard stands by and waits for you to play the first note of the tune. If the tune includes intro measures, the keyboard enters standby after the intro measures are complete.

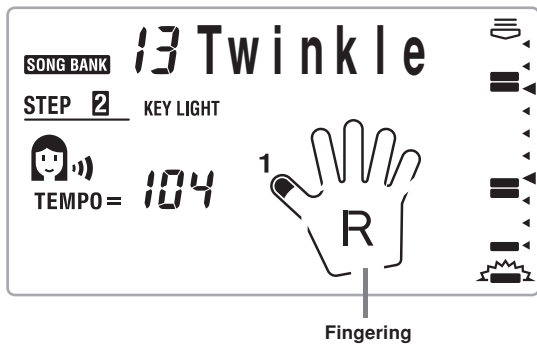

2. Play the notes indicated by the 3-Step Lesson System.
 - The accompaniment (left hand) part of the tune follows along as you play the melody (right hand) part.
 - The keyboard key that corresponds to the next note to be played flashes, and lights when you play the note.
 - The rhythm (percussion) part does not sound.

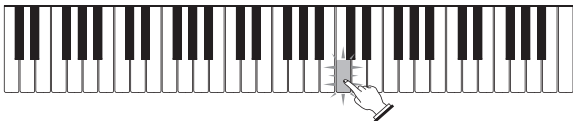

Press keyboard keys as they light. More than one key may light when you are playing a two-hand tune. Press all keys that light.

3. To stop play at any time, press the START/STOP button.
 - When you do, the STEP 2 indicator goes out.

Step 3: Play at normal speed

1. Press the STEP 3 button.
 - When you do, the STEP 3 indicator appears.
 - Play starts after a count sounds.

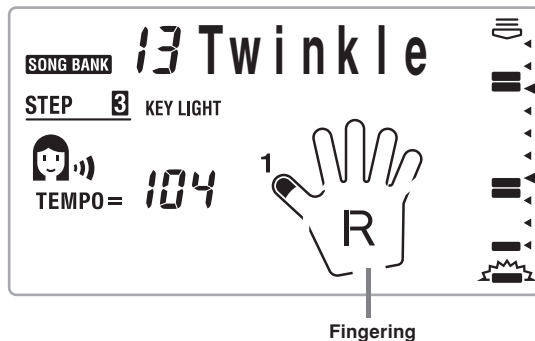

2. Play along on the keyboard, following the keys as they light.
 - The accompaniment (left hand) part of the tune plays at normal speed, regardless of what you play on the keyboard.
 - With an auto-accompaniment tune, the keyboard key that corresponds to the next note to be played flashes, and lights when the note should be played.
 - With a two-hand tune, the applicable keyboard key remains lit as long as its note plays. In this case, however, the key for the next note to be played does not flash. Keys light when their notes start to play.

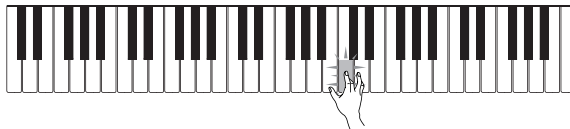

3. To stop play at any time, press the START/STOP button.
 - When you do, the STEP 3 indicator goes out.

To practice the left hand part

Once you master right hand part play, you can use the two-hand tunes (numbers 84 through 99) to practice left hand part.

1. Press the SONG BANK button until the SONG BANK indicator appears.
 - This causes the number and name of the currently selected Song Bank tune to appear on the display.
2. Input the two digit number for the tune you want to play.
3. Press the PART SELECT button to switch the left hand play.

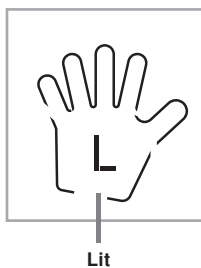

4. Press the STEP 1, STEP 2, or STEP 3 button.
 - When you do, the STEP 1, STEP 2, or STEP 3 indicator appears.
 - After a count beat sounds, the right-hand part starts to play and the keys for the left-hand part notes flash.
5. Press the PART SELECT button to return the part selection to its previous setting.
6. To interrupt play of the melody, press the START/STOP button.
 - When you do, the STEP 1, STEP 2, or STEP 3 indicator disappears.

Technical Reference

Troubleshooting

Be sure to check the following table whenever you experience problems with keyboard operation.

Symptom	Cause	Action	See Page
<ul style="list-style-type: none"> No sound when keyboard keys are pressed. 	<ol style="list-style-type: none"> Power supply problem. Volume setting is too low. Headphones are plugged into the keyboard. The POWER/MODE selector is in the CASIO CHORD or FINGERED position. Tone "99 PERCUSSION" is selected and you are pressing keys that are not assigned tones. 	<ol style="list-style-type: none"> Correctly attach the AC adaptor, make sure that batteries (+/-) are facing correctly, and check to make sure that batteries are not dead. Use the VOLUME slider to increase volume. Unplug the headphones from the PHONES/OUTPUT jack. Normal play is not possible on the accompaniment keyboard while the POWER/MODE selector is set to CASIO CHORD or FINGERED. Change the POWER/MODE selector setting to NORMAL. While "99 PERCUSSION" is selected, you can use only keys that are marked on the console with illustrations of percussion instruments. 	<p>Page E-11</p> <p>Page E-14</p> <p>Page E-13</p> <p>Page E-17</p> <p>Page E-14</p>
<ul style="list-style-type: none"> Any of the following symptoms while using battery power. 	<ul style="list-style-type: none"> Low battery power 	<ul style="list-style-type: none"> Replace the batteries with a set of new ones or use the AC adaptor. 	<p>Page E-11</p>
<ul style="list-style-type: none"> Instrument does not turn on Display that is flickering, dim, or difficult to read Abnormally low speaker/headphone volume Distortion of sound output Occasional interruption of sound when playing at high volume Sudden power failure when playing at high volume Flickering or dimming of the display when playing at high volume Continued sound output even after you release a key A tone that is totally different from the one that is selected Abnormal rhythm pattern and Song Bank play 			
<ul style="list-style-type: none"> Key light stays on. 	<ul style="list-style-type: none"> Keyboard is waiting for play of the correct note during Step 1 or Step 2 play. 	<ol style="list-style-type: none"> Press the lit key to continue with Step 1 or Step 2 play. Press the START/STOP button to quit Step 1 or Step 2 play. 	<p>Pages E-23, 24</p> <p>Pages E-23, 24</p>
<ul style="list-style-type: none"> RHYTHM button does not work. 	<ul style="list-style-type: none"> Keyboard is in the Song Bank Mode. 	<ul style="list-style-type: none"> Press the SONG BANK button to return to the normal mode. 	<p>Page E-20</p>

Symptom	Cause	Action	See Page
<ul style="list-style-type: none"> • Cannot change TRANSPOSE/TUNE settings. 	<ul style="list-style-type: none"> • Keyboard is in the Song Bank Mode. • Demo tune play is in progress. 	<ul style="list-style-type: none"> • Press the SONG BANK button to return to the normal mode. • Stop demo tune play. 	Page E-20 Page E-16
A tone's quality and volume sounds slightly different depending where it is played on the keyboard.	This is an unavoidable result of the digital sampling process,* and does not indicate malfunction. * Multiple digital samples are taken for the low range, middle range, and high range of the original musical instrument. Because of this, there may be a very slight difference in tonal quality and volume between sample ranges.		

Specifications

Model:	LK-120/LK-125
Keyboard:	61 standard-size keys; 5 octaves
Key Light System:	Can be turned on and off (up to 4 keys can be lit at the same time)
Tones:	100 presets
Polyphony:	12 notes maximum
3-Step Lesson System:	Number of simultaneously lit keys; 4 3-Steps Playback: Voice Fingering Guide: 1 tune repeat playback On/Off
Auto-accompaniment	
Rhythm patterns:	50 presets
Tempo:	Adjustable, (216 steps, ♩ = 40 to 255), initial value; 120
Chords:	Two systems; CASIO CHORD, FINGERED
Other:	Fill-in pattern, Synchro start
Song Bank tunes:	100 tunes
Musical Information Function:	Tone, Auto Accompaniment, Song Bank numbers and names; tempo, 3 step lesson display, chord name, fingering, timing indicator, key lighting, voice fingering
Other Functions	
Transpose:	F# to C to F: half-note
Tuning:	Adjustable A4 = Approx. 440 Hz ±50 cents, Initial value: A4 = Approx. 440 Hz
Speakers:	10 cm diameter × 2 (Output: 2W+2W)
I/O Terminals	
Power Supply:	DC 9.5V jack
Headphones/Output:	Stereo standard jack (Output is monaural.) [output impedance: 78Ω, output voltage: 4V (RMS) MAX]
Power Supply:	
Batteries:	2-way 6 AA-size zinc-carbon batteries or alkaline batteries Battery Life: Approximately 4 hours continuous operation on alkaline batteries Approximately 1 hour continuous operation on zinc-carbon batteries
AC adaptor :	AD-E95100L
Auto Power Off:	Approximately 6 minutes after the last operation
Power Consumption:	9.5 V --- 7.7 W
Dimensions:	94.9 × 30.4 × 9.3 cm (37 ³ / ₈ × 11 ¹⁵ / ₁₆ × 3 ¹¹ / ₁₆ inch)
Weight:	Approximately 3.4 kg (7.5 lbs) (without batteries)

* Designs and specifications are subject to change without notice.

Operating Precautions

Be sure to read and observe the following operating precautions.

□ Location

Avoid the following locations for this product.

- Areas exposed to direct sunlight and high humidity
- Areas subjected to temperature extremes
- Near a radio, TV, video deck, or tuner

The above devices will not cause malfunction of the product, but the product can cause interference in the audio or video of a nearby device.

□ User Maintenance

- Never use benzine, alcohol, thinner, or other chemical agents to clean the product.
- To clean the product or its keyboard, wipe with a soft cloth moistened in a weak solution of water and a mild neutral detergent. Wring all excess moisture from the cloth before wiping.

□ Included and Optional Accessories

Use only accessories that are specified for use with this product.

Use of unauthorized accessories creates the risk of fire, electric shock, and personal injury.

□ AC Adaptor Handling Precautions

- Use a power outlet that is easily accessible so you can unplug the AC adaptor when a malfunction occurs or whenever else you need to do so.
- The AC adaptor is intended for indoor use only. Do not use it where it might be exposed to splashing or moisture. Do not place any container, such as a flower vase, that contains liquid on the AC adaptor.
- Store the AC adaptor in a dry place.
- Use the AC adaptor in an open, well-ventilated area.
- Never cover the AC adaptor with newspaper, a table cloth, a curtain, or any other similar item.
- Unplug the AC adaptor from the power outlet if you do not plan to use the product for a long time.
- Never try to repair the AC adaptor or modify it in any way.
- AC adaptor operating environment
 - Temperature: 0 to 40°C
 - Humidity: 10% to 90% RH
- Output polarity: 

□ Weld Lines

Lines may be visible on the exterior of the product. These are “weld lines” that result from the plastic molding process. They are not cracks or scratches.

□ Musical Instrument Etiquette

Always be aware of others around you whenever using this product. Be especially careful when playing late at night to keep the volume at levels that do not disturb others. Other steps you can take when playing late at night are closing windows and using headphones.

- Any reproduction of the contents of this manual, either in part or its entirety, is prohibited. Except for your own, personal use, any other use of the contents of this manual without the consent of CASIO is prohibited under copyright laws.
- IN NO EVENT SHALL CASIO BE LIABLE FOR ANY DAMAGES WHATSOEVER (INCLUDING, WITHOUT LIMITATION, DAMAGES FOR LOSS OF PROFITS, BUSINESS INTERRUPTION, LOSS OF INFORMATION) ARISING OUT OF THE USE OF OR INABILITY TO USE THIS MANUAL OR PRODUCT, EVEN IF CASIO HAS BEEN ADVISED OF THE POSSIBILITY OF SUCH DAMAGES.
- The contents of this manual are subject to change without notice.
- The actual appearance of the product may be different from that shown in the illustrations in this User's Guide.
- Company and product names used in this manual may be registered trademarks of others.

Appendix/Apéndice

Tone List

Lista de sonidos

PIANO	
00	PIANO 1
01	PIANO 2
02	HONKY-TONK
03	STUDIO PIANO
04	ELEC PIANO 1
05	ELEC PIANO 2
06	ELEC PIANO 3
07	ELEC PIANO 4
08	HARPSICHORD
09	CLAVELECTRO
ORGAN	
10	ELEC ORGAN 1
11	ELEC ORGAN 2
12	ELEC ORGAN 3
13	ELEC ORGAN 4
14	CHURCH ORGAN
15	PIPE ORGAN
16	REED ORGAN
17	ACCORDION
18	BANDONEON
19	HARMONICA
GUITAR/BASS	
20	GUT GUITAR
21	ACOUS GUITAR
22	JAZZ GUITAR
23	ELEC GUITAR
24	MUTE GUITAR
25	DIST GUITAR
26	WOOD BASS
27	ELEC BASS
28	SLAP BASS
29	BANJO
STRINGS/ENSEMBLE	
30	VIOLIN
31	CELLO
32	HARP
33	STRINGS 1
34	STRINGS 2
35	STRINGS 3
36	SYNTH-STR 1
37	SYNTH-STR 2
38	CHOIR
39	VOICE OOH

BRASS/REED/PIPE	
40	TRUMPET
41	TUBA
42	BRASS ENS
43	FR.HORN 1
44	FR.HORN 2
45	BRASS 1
46	BRASS 2
47	SYN-BRASS 1
48	SYN-BRASS 2
49	SYN-BRASS 3
50	SOPRANO SAX
51	ALTO SAX
52	TENOR SAX
53	OBOE
54	CLARINET
55	PICCOLO
56	FLUTE
57	RECORDER
58	PAN FLUTE
59	WHISTLE
SYNTH-SOUND	
60	SYN-LEAD 1
61	SYN-LEAD 2
62	SYN-LEAD 3
63	SYN-CALLIOPE
64	SYN-PAD 1
65	SYN-PAD 2
66	SYN-PAD 3
67	GLASS HMCA
68	COUNTRY FARM
69	SYN-BASS
70	PEARL DROP
71	COSMIC SOUND
72	SOUNDTRACK
73	SPACE PAD
74	VOICE BASS
75	APPLAUSE
76	SYNTH-SFX
77	VEHICLE
78	PHONE
79	FUNNY

LAYER	
80	STR PIANO
81	STR E.PIANO
82	CHOIR E.P
83	CHOIR ORGAN
84	STR GUITAR
85	STR HARP
86	BRASS STR
87	VIB PAD
88	12 STR GTR
89	CHOIR STR
SPLIT/PERCUSSION	
90	BASS/PIANO
91	BASS/E.PIANO
92	BASS/VIB
93	BASS/GUT GTR
94	V.BASS/OOH
95	STR/PIANO
96	STR/TRUMPET
97	VIBRAPHONE
98	MARIMBA
99	PERCUSSION

Rhythm List

Lista de ritmos

POPS I	
00	CLUB POP
01	FUNKY POP
02	SOUL BALLAD
03	POP BALLAD
04	LITE POP
POPS II	
05	16 BEAT FUNK
06	8 BEAT POP
07	POP ROCK
08	DANCE POP
09	POP FUSION
10	FOLKIE POP
ROCK	
11	ROCK WALTZ
12	SLOW ROCK
13	SOFT ROCK
14	50'S ROCK
15	60'S SOUL
16	4 BEAT ROCK
17	ROCK
18	TWIST
19	NEW ORLNS R&R
20	R&B
JAZZ/FUSION	
21	BIG BAND
22	SWING
23	FOX TROT
24	JAZZ WALTZ
25	LATIN FUSION

DANCE/FUNK	
26	TECHNO
27	TRANCE
28	DISCO
29	FUNK
30	RAP
EUROPEAN	
31	POLKA
32	MARCH
33	WALTZ
34	SLOW WALTZ
35	TANGO
LATIN	
36	BOSSA NOVA
37	SAMBA
38	MAMBO
39	REGGAE
40	SKA
41	SALSA
42	FOLKLORE
43	RUMBA CATALANA
VARIOUS	
44	COUNTRY
45	TOWNSHIP
46	SLOW GOSPEL
47	BALADI
48	BAROQUE
49	NEW AGE

Fingered Chord Charts

Cuadros de acordes digitados

This table shows the left-hand fingerings (including inverted forms) for a number of often-used chords.

Esta tabla muestra las digitaciones (incluyendo las formas invertidas) para varios de los acordes más a menudo usados.

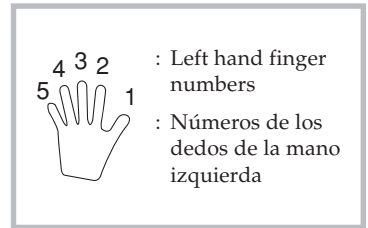

Chord Root Type	M	m	7	m7	dim7	M7	m7 ^b 5	dim
C	[5, 3, 1]	[5, 3, 1]	[5, 3, 2, 1]	[5, 3, 2, 1]	[5, 3, 2, 1]	[5, 3, 2, 1]	[5, 3, 2, 1]	[5, 3, 2]
C# (D ^b)	[5, 3, 1]	[5, 3, 1]	[5, 3, 2, 1]	[5, 3, 2, 1]	[5, 3, 2, 1]	[5, 3, 2, 1]	[5, 3, 2, 1]	[5, 3, 2]
D	[5, 3, 1]	[5, 3, 1]	[5, 3, 2, 1]	[5, 3, 2, 1]	[5, 3, 2, 1]	[5, 3, 2, 1]	[5, 3, 2, 1]	[5, 3, 2]
E ^b (D#)	[5, 3, 1]	[5, 3, 1]	[5, 3, 2, 1]	[5, 3, 2, 1]	[5, 3, 2, 1]	[5, 3, 2, 1]	[5, 3, 2, 1]	[5, 3, 2]
E	[5, 3, 1]	[5, 3, 1]	[5, 3, 2, 1]	[5, 3, 2, 1]	[5, 3, 2, 1]	[5, 3, 2, 1]	[5, 3, 2, 1]	[5, 3, 2]
F	[5, 3, 1]	[5, 3, 1]	[5, 3, 2, 1]	[5, 3, 2, 1]	[5, 3, 2, 1]	[5, 3, 2, 1]	[5, 3, 2, 1]	[5, 3, 2]
F# (G ^b)	[5, 3, 1]	[5, 3, 1]	[5, 3, 2, 1]	[5, 3, 2, 1]	[5, 3, 2, 1]	[5, 3, 2, 1]	[5, 3, 2, 1]	[5, 3, 2]
G	[5, 3, 1]	[5, 3, 1]	[5, 3, 2, 1]	[5, 3, 2, 1]	[5, 3, 2, 1]	[5, 4, 2, 1]	[5, 3, 2, 1]	[5, 3, 2]
A ^b (G#)	[5, 3, 1]	[5, 3, 1]	[5, 4, 2, 1]	[5, 4, 2, 1]	[5, 3, 2, 1]	[5, 4, 2, 1]	[5, 4, 2, 1]	[5, 3, 2]
A	[5, 3, 1]	[5, 3, 1]	[5, 4, 2, 1]	[5, 4, 2, 1]	*	[5, 4, 2, 1]	[5, 4, 2, 1]	[5, 3, 2]
B ^b (A#)	[5, 3, 1]	[5, 3, 1]	[5, 4, 2, 1]	[5, 4, 2, 1]	*	[5, 4, 2, 1]	[5, 4, 2, 1]	[5, 3, 2]
B	[5, 2, 1]	[5, 2, 1]	[5, 3, 2, 1]	[5, 3, 2, 1]	*	[5, 3, 2, 1]	[5, 4, 2, 1]	[5, 3, 2]

Chord Root Type	aug	sus4	7 sus4	m add9	m M7	7 ^b 5	add9
C	[5, 3, 1]	[5, 2, 1]	[5, 3, 2, 1]	[4, 3, 2, 1]	[5, 3, 2, 1]	[5, 3, 2, 1]	[4, 3, 2, 1]
C [#] (D ^b)	[5, 3, 1]	[5, 2, 1]	[5, 3, 2, 1]	[4, 3, 2, 1]	[5, 3, 2, 1]	[5, 3, 2, 1]	[4, 3, 2, 1]
D	[5, 3, 1]	[5, 2, 1]	[5, 3, 2, 1]	[4, 3, 2, 1]	[5, 3, 2, 1]	[5, 3, 2, 1]	[4, 3, 2, 1]
E ^b (D [#])	[5, 3, 1]	[5, 2, 1]	[5, 3, 2, 1]	[4, 3, 2, 1]	[5, 3, 2, 1]	[5, 3, 2, 1]	[4, 3, 2, 1]
E	[5, 3, 1]	[5, 2, 1]	[5, 3, 2, 1]	[4, 3, 2, 1]	[5, 3, 2, 1]	[5, 3, 2, 1]	[4, 3, 2, 1]
F	[5, 3, 1]	[5, 2, 1]	[5, 3, 2, 1]	[4, 3, 2, 1]	[5, 3, 2, 1]	[5, 3, 2, 1]	[4, 3, 2, 1]
F [#] (G ^b)	[5, 3, 1]	[5, 2, 1]	[5, 3, 2, 1]	[4, 3, 2, 1]	[5, 3, 2, 1]	[5, 3, 2, 1]	[4, 3, 2, 1]
G	[5, 3, 1]	[5, 2, 1]	[5, 3, 2, 1]	[4, 3, 2, 1]	[5, 4, 2, 1]	[5, 3, 2, 1]	[4, 3, 2, 1]
A ^b (G [#])	[5, 3, 1]	[5, 2, 1]	[5, 4, 2, 1]	[4, 3, 2, 1]	[5, 4, 2, 1]	[5, 4, 2, 1]	[4, 3, 2, 1]
A	[5, 3, 1]	[5, 2, 1]	[5, 4, 2, 1]	[4, 3, 2, 1]	[5, 4, 2, 1]	[5, 4, 2, 1]	[4, 3, 2, 1]
B ^b (A [#])	*	[5, 2, 1]	[5, 4, 2, 1]	[4, 3, 2, 1]	[5, 4, 2, 1]	[5, 4, 2, 1]	[4, 3, 2, 1]
B	*	[5, 2, 1]	[5, 3, 2, 1]	[5, 3, 2, 1]	[5, 3, 2, 1]	[4, 3, 2, 1]	[5, 3, 2, 1]

* Cannot be specified in FINGERED setting because of accompaniment keyboard limitations, but augmented and diminished (seventh) chords made up of the same component notes (with different base note) can be used instead.

Chords with same component notes as B^b aug D aug, F[#] aug
 Chords with same component notes as B aug E^b aug, G aug
 Chords with same component notes as A dim7 C dim7, E^b dim7, F[#] dim7
 Chords with same component notes as B^b dim7 C[#] dim7, E dim7, G dim7
 Chords with same component notes as B dim7 D dim7, F dim7, A^b dim7

* No puede especificarse en el ajuste FINGERED debido a las limitaciones del teclado de acompañamiento, pero en su lugar pueden usarse los acordes aumentados y disminuidos (séptima) compuestos por las mismas notas componentes (con diferente nota básica).

Acordes con las mismas notas componentes como B^b aumentada D aumentada, F[#] aumentada.
 Acordes con las mismas notas componentes como B aumentada E^b aumentada, G aumentada.
 Acordes con las mismas notas componentes como A dim7 C dim7, E^b dim7, F[#] dim7.
 Acordes con las mismas notas componentes como B^b dim7 C[#] dim7, E dim7, G dim7.
 Acordes con las mismas notas componentes como B dim7 D dim7, F dim7, A^b dim7.

Song List / Lista de canciones

SONG BANK / BANCO DE CANCIONES

00	JUPITER FROM "THE PLANETS"
01	DECK THE HALL
02	WE WISH YOU A MERRY CHRISTMAS
03	JINGLE BELLS
04	SILENT NIGHT
05	JOY TO THE WORLD
06	O CHRISTMAS TREE
07	WHEN THE SAINTS GO MARCHING IN
08	GREENSLEEVES
09	SWING LOW, SWEET CHARIOT
10	AMAZING GRACE
11	JOSHUA FOUGHT THE BATTLE OF JERICHO
12	AULD LANG SYNE
13	TWINKLE TWINKLE LITTLE STAR
14	LIGHTLY ROW
15	SUMM SUMM SUMM
16	THE MUFFIN MAN
17	LONG LONG AGO
18	ACH DU LIEBER AUGUSTIN
19	LONDON BRIDGE
20	SUR LE PONT D'AVIGNON
21	UNDER THE SPREADING CHESTNUT TREE
22	SIPPIN' CIDER THROUGH A STRAW
23	GRANDFATHER'S CLOCK
24	THE NOBLE DUKE OF YORK
25	MICHAEL ROW THE BOAT ASHORE
26	DANNY BOY
27	ANNIE LAURIE
28	MY BONNIE
29	IF YOU'RE HAPPY AND YOU KNOW IT, CLAP YOUR HANDS
30	MY DARLING CLEMENTINE
31	HOME SWEET HOME
32	MY WILD IRISH ROSE
33	DOWN IN THE VALLEY
34	J'AI PERDU LE DO DE MA CLARINETTE
35	I'VE BEEN WORKING ON THE RAILROAD
36	LITTLE BROWN JUG
37	ON TOP OF OLD SMOKEY
38	AMERICA THE BEAUTIFUL
39	AURA LEE
40	OH! SUSANNA
41	BEAUTIFUL DREAMER
42	HOUSE OF THE RISING SUN
43	SHE WORE A YELLOW RIBBON
44	WHEN JOHNNY COMES MARCHING HOME
45	CAMPTOWN RACES
46	SWANEE RIVER (OLD FOLKS AT HOME)
47	JEANNIE WITH THE LIGHT BROWN HAIR
48	YANKEE DOODLE
49	RED RIVER VALLEY

50	TURKEY IN THE STRAW
51	MY OLD KENTUCKY HOME
52	HOME ON THE RANGE
53	ALOHA OE
54	JAMAICA FAREWELL
55	SAKURA SAKURA
56	HOLDIRIDIA
57	LA CUCARACHA
58	LA PALOMA
59	SANTA LUCIA
60	CIELITO LINDO
61	TROIKA
62	SZLA DZIEWECZKA
63	WALTZING MATILDA
64	AJO MAMMA
65	RASA SAYANG
66	AIR FROM "SUITE no.3"
67	SPRING FROM "THE FOUR SEASONS"
68	TOY SYMPHONY
69	SYMPHONY no.101 "CLOCK" 2nd Mov.
70	SERENADE FROM "EINE KLEINE NACHTMUSIK"
71	ODE TO JOY
72	BRIDAL MARCH FROM "LOHENGRIN"
73	TRIUMPHAL MARCH FROM "AIDA"
74	BRINDISI FROM "LA TRAVIATA"
75	LA DONNA É MOBILE FROM "RIGOLETTE"
76	POLKA FROM "THE BARTERED BRIDE"
77	CHANSON DU TOREADOR FROM "CARMEN"
78	HABANERA FROM "CARMEN"
79	PRELUDE FROM "L'ARLÉSIENNE"
80	LE CYGNE FROM "LE CARNAVAL DES ANIMAUX"
81	MARCH FROM "THE NUTCRACKER"
82	SCENE FROM "SWAN LAKE"
83	THAIS MEDITATION
84	THE ENTERTAINER
85	FÜR ELISE
86	PIANO SONATA op.13 "PATHÉTIQUE" 2nd Mov.
87	PIANO SONATA op.27-2 "MOONLIGHT" 1st Mov.
88	TURKISH MARCH (MOZART)
89	PIANO SONATA K.545 1st Mov.
90	VALSE op.64-1 "PETIT CHIEN"
91	CHOPSTICKS
92	FRÖHLICHER LANDMANN
93	AMERICAN PATROL
94	JESUS BLEIBET MEINE FREUDE
95	MINUET IN G MAJOR
96	GAVOTTE (GOSSEC)
97	CANON (PACHELBEL)
98	HUNGARIAN DANCES no.5
99	WEDDING MARCH FROM "MIDSUMMER NIGHT'S DREAM"



This recycle mark indicates that the packaging conforms to the environmental protection legislation in Germany.

Esta marca de reciclaje indica que el empaquetado conforma a la legislación de protección ambiental en Alemania.

CASIO®