

**1 YEAR**  
WARRANTY

MADE IN  
**USA**

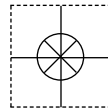

# User's Guide



*Shop online at*

**omega.com<sup>®</sup>**

Ω OMEGA<sup>®</sup>

*www.omega.com*

*e-mail: info@omega.com*

**ISO 9001**  
CERTIFIED  
CORPORATE QUALITY

STAMFORD, CT

**ISO 9002**  
CERTIFIED  
CORPORATE QUALITY

MANCHESTER, UK

# DMD-519

## Single Channel High Performance Strain Gage Amplifier



**OMEGAnet® Online Service**  
**www.omega.com**

**Internet e-mail**  
**info@omega.com**

### **Servicing North America:**

**USA:**  
ISO 9001 Certified

One Omega Drive, P.O. Box 4047  
Stamford CT 06907-0047  
TEL: (203) 359-1660 FAX: (203) 359-7700  
e-mail: info@omega.com

**Canada:**

976 Bergar  
Laval (Quebec) H7L 5A1  
TEL: (514) 856-6928 FAX: (514) 856-6886  
e-mail: info@omega.ca

### **For immediate technical or application assistance:**

**USA and Canada:** Sales Service: 1-800-826-6342 / 1-800-TC-OMEGA®  
Customer Service: 1-800-622-2378 / 1-800-622-BEST®  
Engineering Service: 1-800-872-9436 / 1-800-USA-WHEN®  
TELEX: 996404 EASYLINK: 62968934 CABLE: OMEGA

**Mexico:**

En Español: (001) 203-359-7803 e-mail: espanol@omega.com  
FAX: (001) 203-359-7807 info@omega.com.mx

### **Servicing Europe:**

**Benelux:**

Postbus 8034, 1180 LA Amstelveen, The Netherlands  
TEL: +31 (0)20 3472121 FAX: +31 (0)20 6434643  
Toll Free in Benelux: 0800 0993344  
e-mail: sales@omegaeng.nl

**Czech Republic:**

Rudé armády 1868, 733 01 Karviná 8  
TEL: +420 (0)59 6311899 FAX: +420 (0)59 6311114  
Toll Free: 0800-1-66342 e-mail: info@omegashop.cz

**France:**

11, rue Jacques Cartier, 78280 Guyancourt, France  
TEL: +33 (0)1 61 37 29 00 FAX: +33 (0)1 30 57 54 27  
Toll Free in France: 0800 466 342  
e-mail: sales@omega.fr

**Germany/Austria:**

Daimlerstrasse 26, D-75392 Deckenpfronn, Germany  
TEL: +49 (0)7056 9398-0 FAX: +49 (0)7056 9398-29  
Toll Free in Germany: 0800 639 7678  
e-mail: info@omega.de

**United Kingdom:**

ISO 9002 Certified

One Omega Drive, River Bend Technology Centre  
Northbank, Irlam, Manchester  
M44 5BD United Kingdom  
TEL: +44 (0)161 777 6611 FAX: +44 (0)161 777 6622  
Toll Free in United Kingdom: 0800-488-488  
e-mail: sales@omega.co.uk

---

It is the policy of OMEGA to comply with all worldwide safety and EMC/EMI regulations that apply. OMEGA is constantly pursuing certification of its products to the European New Approach Directives. OMEGA will add the CE mark to every appropriate device upon certification.

The information contained in this document is believed to be correct, but OMEGA Engineering, Inc. accepts no liability for any errors it contains, and reserves the right to alter specifications without notice.

**WARNING:** These products are not designed for use in, and should not be used for, patient-connected applications.

**TABLE OF CONTENTS**  
**DMD-519**  
**SINGLE CHANNEL HIGH PERFORMANCE**  
**STRAIN GAGE AMPLIFIER**

<b>SECTION</b>	<b>PAGE</b>
<b>SECTION 1 INTRODUCTION</b> . . . . .	<b>1</b>
1.1 Description . . . . .	1
1.2 Accessories . . . . .	1
<b>SECTION 2 UNPACKING</b> . . . . .	<b>1</b>
<b>SECTION 3 PARTS OF THE DMD-519</b> . . . . .	<b>2</b>
3.1 The DMD-519 . . . . .	2
3.2 Front of the DMD-519-BP . . . . .	3
3.3 Rear of the DMD-519-BP . . . . .	4
<b>SECTION 4 SETUP</b> . . . . .	<b>5</b>
4.1 Power Connections . . . . .	5
4.2 Wiring . . . . .	5
4.3 Hookup . . . . .	5
<b>SECTION 5 SCALING</b> . . . . .	<b>7</b>
5.1 Warm up Time . . . . .	7
5.2 Scaling . . . . .	7
<b>SECTION 6 FUNCTIONAL CHECKOUTS</b> . . . . .	<b>10</b>
6.1 Auto-Balance Mode (Internal PCB Switch SW5 "UP") . . . . .	10
6.2 Amplifier . . . . .	11
<b>SECTION 7 SPECIFICATIONS</b> . . . . .	<b>12</b>

## SECTION 1 INTRODUCTION

### 1.1 DESCRIPTION

The OMEGA DMD-519 High Performance Strain Gage Amplifier is a single channel amplifier for bridge-type instrumentation. It features selectable 120/350 ohm bridge completion resistors, selectable auto-balance circuit, and adjustable bridge excitation. The DMD-519-BP rack mount assembly can accommodate up to 16 DMD-519 amplifiers. An unregulated AC to DC transformer is internally mounted at the rear of the rack to energize all sixteen amplifiers. Each amplifier has its' own on-board regulator to provide the voltages required for the logic circuits, op-amps, and bridge excitation. As a result, a load fault to any amplifier will not affect any of the other amplifiers.

### 1.2 ACCESSORIES

The following accessory must be purchased from OMEGA Engineering, Inc and used in conjunction with the DMD-519.

<u>PART NUMBER</u>	<u>DESCRIPTION</u>
DMD-519-BP	Rack Mount for 16 DMD-519 modules

## SECTION 2 UNPACKING

Remove the Packing List and verify that all equipment has been received. If there are any questions about the shipment, please call the OMEGA Customer Service Department at 1-800-622-2378 or (203) 359-1660.

Upon receipt of shipment, inspect the container and equipment for any signs of damage. Take particular note of any evidence of rough handling in transit. Immediately report any damage to the shipping agent.

### NOTE

The carrier will not honor any claims unless all shipping material is saved for their examination. After examining and removing contents, save packing material and carton in the event reshipment is necessary.

Make sure the following is in the packing box:

<u>QTY</u>	<u>DESCRIPTION</u>
1	DMD-519 (single channel strain gage amplifier)
1	Operator's manual
1*	115VAC power cord, detachable, 6 ft
16*	6-pin twist lock male connectors (OMEGA part number DMD-520-Connector required, sold separately)

\* Included with DMD-519-BP only

## SECTION 3 PARTS OF THE DMD-519

### 3.1 THE DMD-519

Figure 3-1 shows the front panel view of the DMD-519.

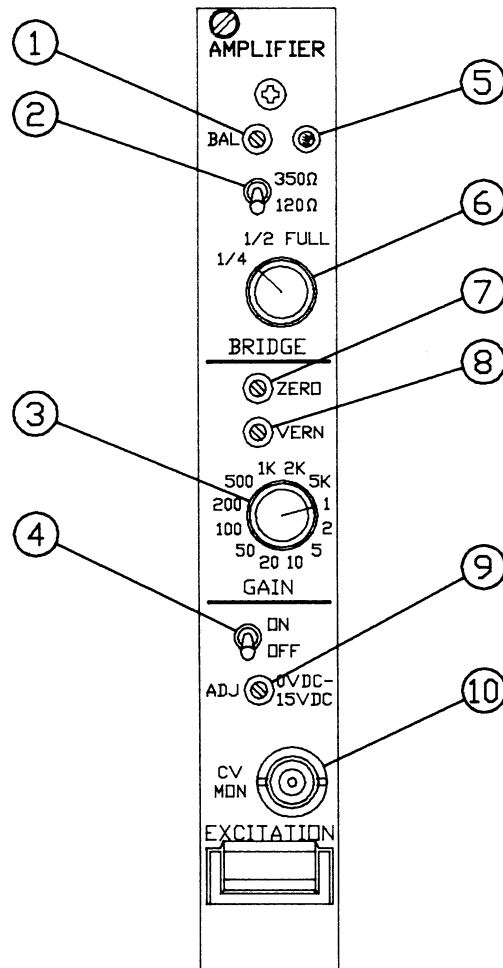

Figure 3-1. DMD-519

KEY	DESCRIPTION
1	Manual Bridge Balance Trimpot
2	Bridge Completion Resistor Value Toggle Switch
3	Fixed Gain Selector Switch
4	Bridge Excitation On/Off Switch
5	Auto balance LED Indicator
6	Bridge Configuration Switch
7	Amplifier Zero Trimpot
8	Fixed Gain Attenuator
9	Bridge Excitation Adjustment Trimpot
10	BNC Bridge Excitation Monitor

### 3.2 FRONT OF THE DMD-519-BP

Figure 3-2 shows the front of the DMD-519 mounted in the DMD-519-BP. Following the figure is a description of each part of the unit.

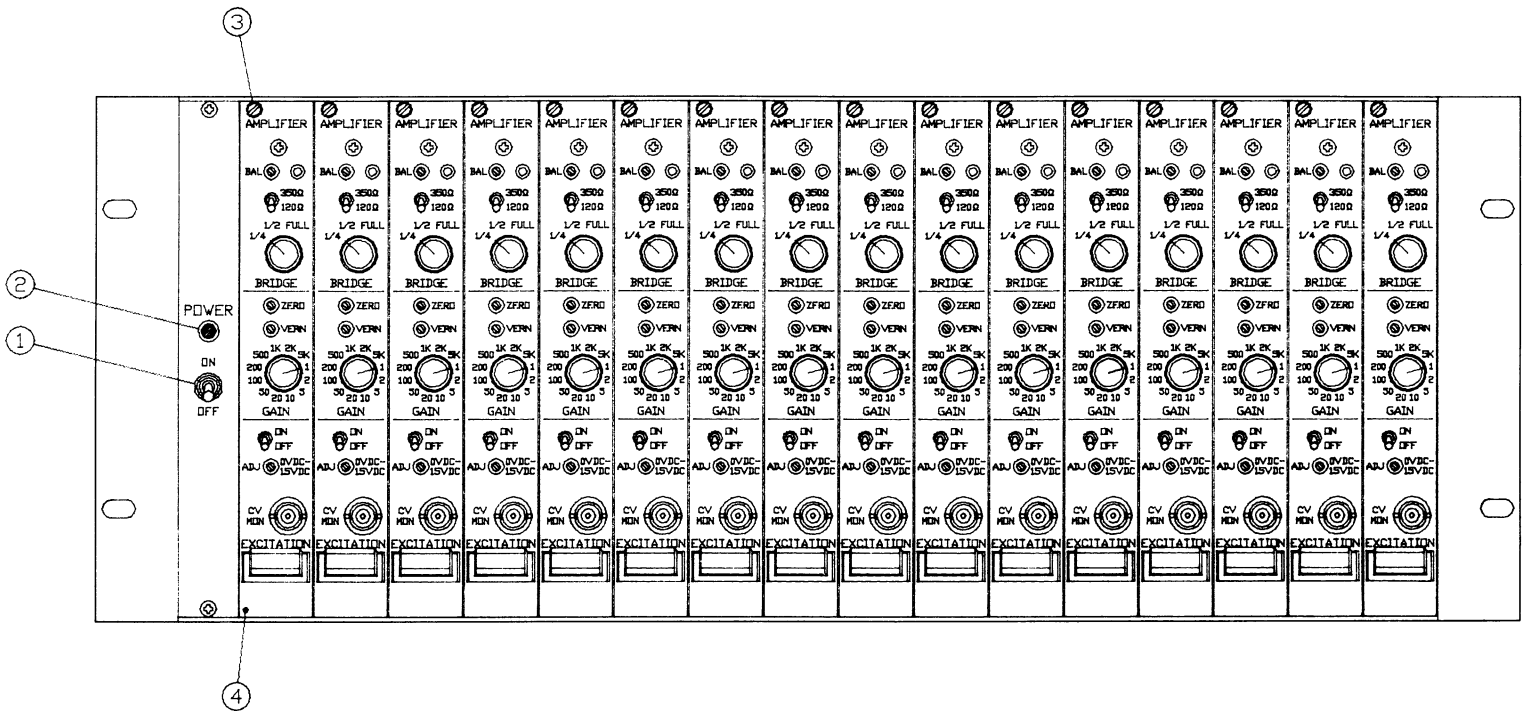
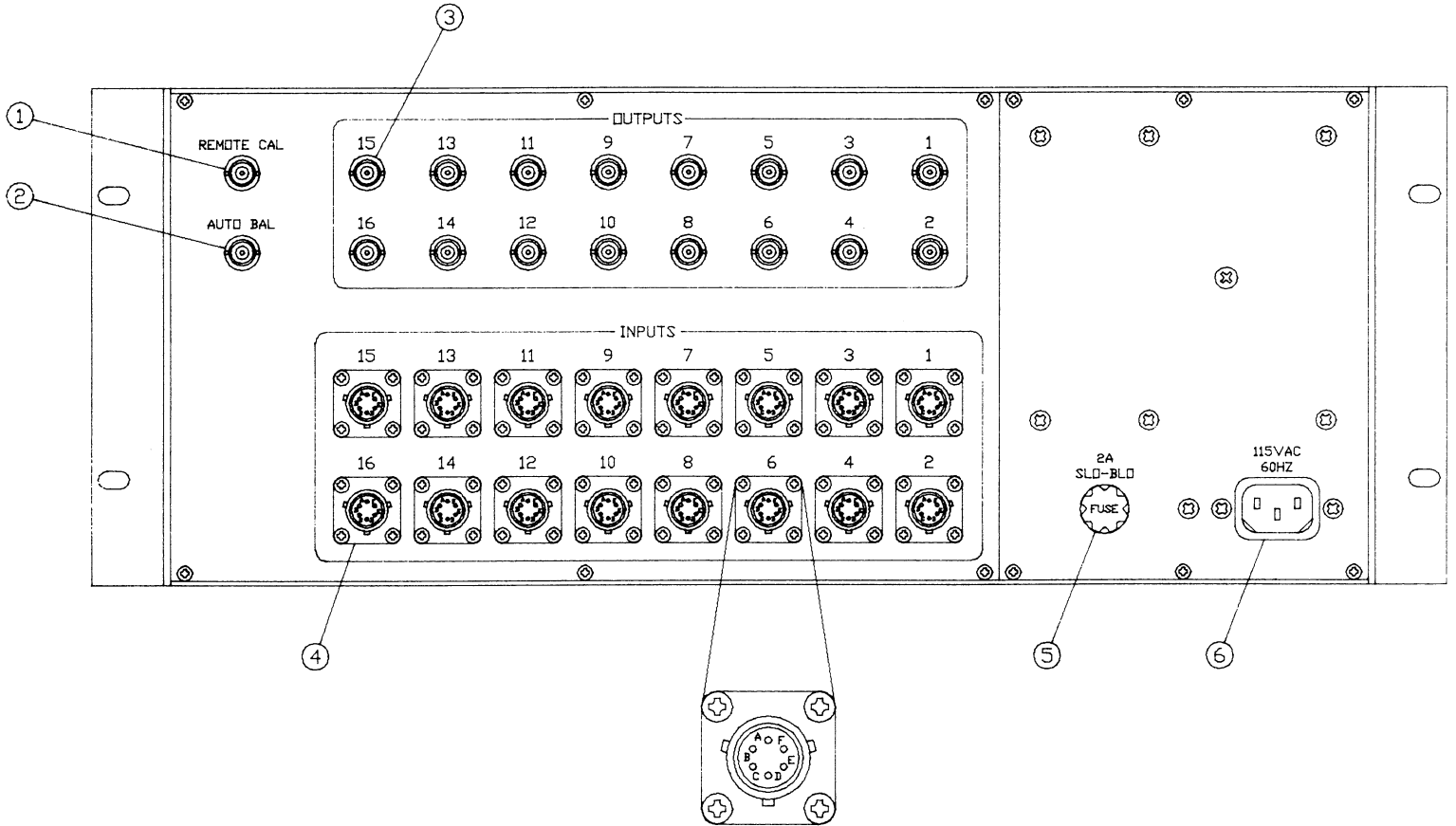

Figure 3-2. Front of the DMD-519-BP

KEY	DESCRIPTION
1	Power switch
2	Indicator light
3	Knurled screw to unscrew/screw PC Board in rack mount
4	One of 16 amplifiers installed

### 3.3 REAR OF THE DMD-519-BP

Figure 3-3 shows the rear of the DMD-519-BP. Following the figure is a description of each part of the unit.



**Figure 3-3. Rear of the DMD-519-BP**

KEY	DESCRIPTION
1	REMOTE CAL BNC
2	AUTO CAL BNC
3	Output connectors (1 of many)
4	Input connectors (1 of many)
5	Fuse holder for 2A slow-blow fuse
6	Power cord socket

## SECTION 4 SETUP

### 4.1 POWER CONNECTIONS

The DMD-519 amplifier is powered by 24VAC supplied by the DMD-519-BP rack mount. The DMD-519-BP rack mounted is supplied by 115VAC. A power cord is supplied with the DMD-519-BP rack mount.

Each DMD-519 amplifier module is plugged into a slot on the front face of the DMD-519-BP rack mount and is fastened by a special slotted knurled screw in the upper left corner. The PC Board slots are initially covered by front panel filler plates that have to be removed for each module installed. The power switch for the system is found on the left side of the front panel.

### 4.2 WIRING

The input to each amplifier is via a 6-pin twist lock connector (OMEGA P/N PT06F8-6S supplied with the unit). The amplifier output is via a BNC connector. These connections are found on the back panel on the DMD-519-BP rack mount. The pin assignments for the input twist lock connector are:

<u>PIN</u>	<u>CONNECTION</u>	<u>SYMBOL</u>
A	+ excitation	(+P)
B	- excitation	(-P)
C	Reference/shield	(R)
D	- signal	(-S)
E	+ signal	(+S)
F	chassis ground	
	+ signal	(+S)

### 4.3 HOOKUP

Figures 4-1, 4-2, 4-3 and 4-4 show how to wire up the bridge configurations. Figure 4-5 shows the internal wiring configuration.

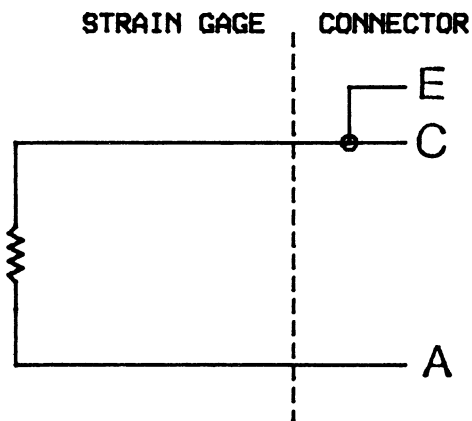

Figure 4-1. 1/4 Bridge (Two-wire gage)



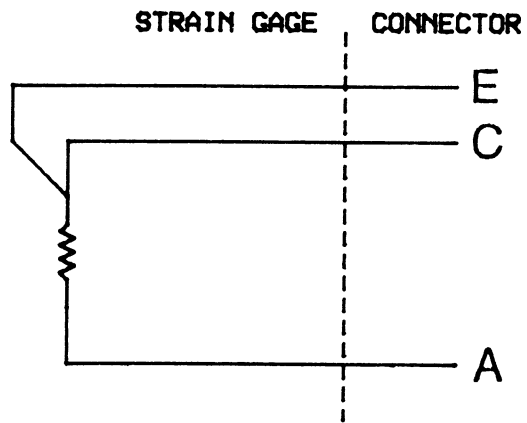

Figure 4-2. 1/4 Bridge (Three-wire gage)

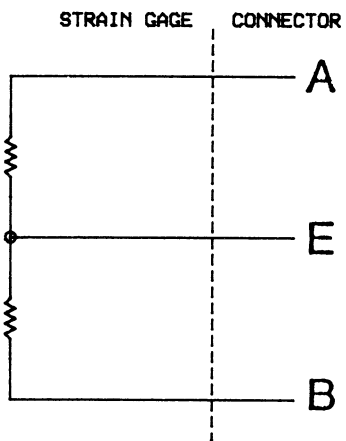

Figure 4-3. 1/2 Bridge

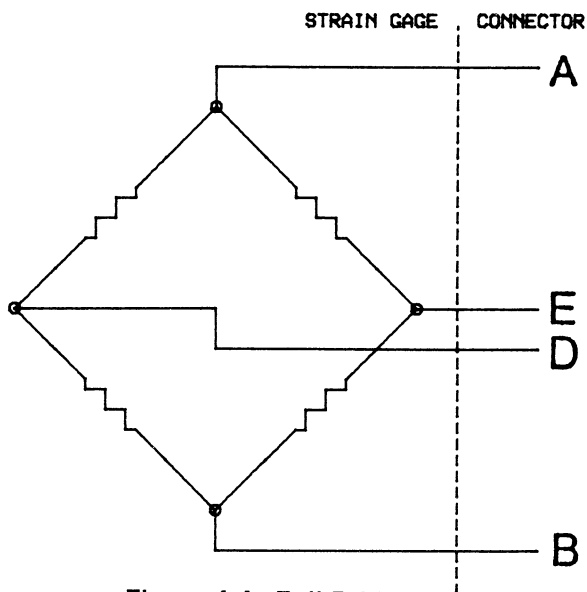

Figure 4-4. Full Bridge

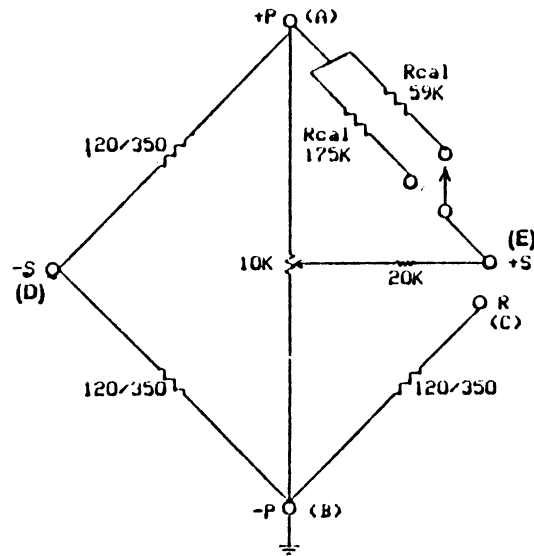

Figure 4-5. Internal Wiring

## SECTION 5 SCALING

### 5.1 WARM UP TIME

Allow the amplifier system to warm up for at least 1 hour.

### 5.2 SCALING

1. Remove the module from the rack and place the auto-balance switch on the printed circuit board to the "OUT" position. The switch is located on the top middle part of the board and labelled "SW5". Replace the module.
2. Select the bridge configuration on the front panel (1/4, 1/2 or full) and the desired bridge completion resistor values (120 or 350 ohm toggle switch).
3. Set the bridge excitation voltage with the adjustment trimpot. This voltage is measured from the front panel BNC connector.
4. Allow the rack to warm up for at least one hour.
5. With the bridge excitation toggle switch set to "OFF", and the desired gain range selected, zero the amplifier with the zero-trimpot.
6. With the balance excitation toggle switch set to "ON", zero the bridge by adjusting the "BAL" trimpot.

7. Calculate the strain which will be simulated with the "REMOTE CAL" BNC using the following equations:

**RCAL EQUATIONS**

For 120 ohm bridge:

$$S = \frac{R_g}{(GF) (59,000)}$$

For 350 ohm bridge:

$$S = \frac{R_g}{(GF) (175,000)}$$

**EXAMPLE** With strain gages having a resistance of 123 ohms (the resistances are the same if they are used from the same box), and the gage factor is 1.97, the strain simulated from the shunt cal would be:

$$S = \frac{123}{(1.97) (59,000)} = 0.001058$$

$$S = 1,058 \text{ microstrain}$$

where S = microstrain  
 Rg = gage resistance  
 GF = gage factor

If the lead lengths are considerable, the GF in the above example needs to be adjusted. The adjusted GF (GF') would be:

1/4 bridge:  
 (2-wire)

$$GF' = \frac{GF \times R_G}{(R_G + 2R_L)}$$

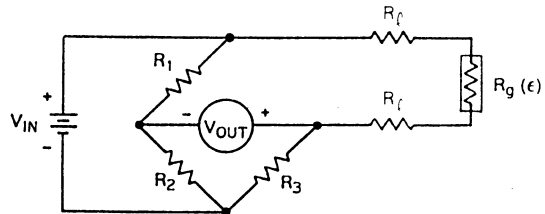

1/4 bridge:  
(3-wire)

$$GF' = \frac{GF \times RG}{(RG + RL)}$$

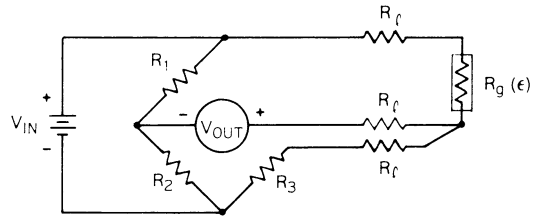

1/2 bridge:

$$GF' = \frac{GF \times RG}{(RG + RL)}$$

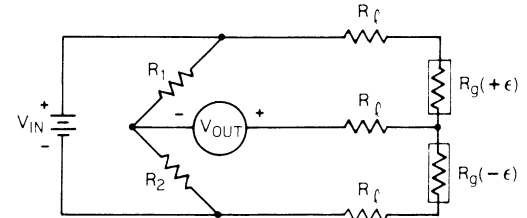

where:  $GF'$  = adjusted gage factor  
 $GF$  = initial gage factor  
 $RG$  = gage resistance  
 $RL$  = lead resistance

$GF'$  is simply substituted for  $GF$  either Rcal equation stated above.

8. Calculate the gain required using the following equation:

$$\text{Gain} = \frac{(4) (OV)}{(S) (EV) (GF) (N)}$$

where:  $S$  = strain (microstrain  $\times 10^{-6}$ )  
 $OV$  = required output voltage  
 $EV$  = excitation voltage  
 $GF$  = gage factor  
 $N$  = number of strain gages

**EXAMPLE** If an output voltage ( $OV$ ) required is 10 volts at the previously figured out strain (0.001058), and a half bridge circuit with a  $GF$  of 2.10 is being used with an excitation voltage of 5 volts, the required gain would be calculated as follows:

$$\text{Gain} = \frac{(4) (10)}{(0.001058) (5.0) (2.10) (2)} = 1800$$

9. Turn the gain switch to the next highest gain setting from the gain calculated above ( in this case, the switch would be set to the "5K" position).
10. Actuate the "REMOTE CAL" BNC at the rear of the rack. Measure the output and adjust to get the proper gain using the fixed gain attenuator.
11. The following have been accomplished:
  - a) the amplifier is zeroed,
  - b) the bridge is balanced,
  - c) the gain has been adjusted,
  - d) the bridge excitation is selected and adjusted and
  - e) the bridge configuration is selected and adjusted.
12. The auto-balance feature enables you to balance all the strain gage bridges for each amplifier simultaneously. The auto-balance is currently in the "OUT" position. In this condition, the auto-balance feature is disabled and the unit is ready to operate. Each amplifier needs to be balanced separately. If the switch is placed in the "IN" position, the auto-balance feature is activated by momentarily shorting the rear panel auto-balance BNC. This will balance all the amplifiers installed in the rack. The balance light is extinguished, and the unit is ready to make measurements. A lighted LED indicates an unbalanceable condition. The primary benefit of the auto-balance is being able to simultaneously balance all of the bridges from day to day, test to test, etc.

## SECTION 6 FUNCTIONAL CHECKOUTS

### 6.1 AUTO-BALANCE MODE (INTERNAL PCB SWITCH SW5 "UP")

1. TURN-ON: with the bridge excitation voltage set to 5V, the bridge mode switch at "FULL", gain at x1000, gain-trim fully counter-clockwise, and a 120 ohm full bridge connected to the bridge-input connector, monitor the OUTPUT BNC with an oscilloscope and DVM.
2. TURN-OFF POWER: Keep "OFF" for 10 seconds minimum to allow Power-On-Preset circuits to re-set.
3. TURN-ON POWER: Scope should display a DC unbalanced output and the "BAL" LED should be lit (with AUTO-BAL "ON").

Short "AUTO-BALANCE" BNC to ground, output should balance to within 15 millivolts (microvolts RTI) and the LED should extinguish indicating a successful balance cycle.

Introduce a severe unbalance by shorting or opening one bridge resistor. Initiate a balance cycle and note that the LED remains lit, indicating that the bridge cannot be balanced electronically. Remove the fault, then initiate a new balance cycle and the LED should extinguish.

Exercise the auto-balance by purposely unbalancing the output with the bridge-balance trimpot. Then re-balance by initiating the auto-zero cycle.

## 6.2 AMPLIFIER

1. **NOISE:** With the 120 ohm bridge still connected, EXCITATION "ON", and the gain at x1000, the true RMS noise should be less than 10mV RMS, or 10 $\mu$ V RTI (typical value is 7mV RMS in the auto-balance mode).

Put the amplifier on MANUAL BALANCE. (Internal PCB switch S5 "DOWN"). The true RMS noise should be less than 5mV RMS, or 5 $\mu$ V RTI. (Typical value is 3mV RMS).

2. **ZERO:** Remove the external full-bridge and prepare to insert an AC signal at the +S and -S input. (Jumper +S to R). With the input shorted, gain at x1000, and the bridge excitation "OFF" null the output DC offset with the "ZERO" trimpot. Scan the offset at all other gains. Offset should remain within  $\pm$ 10mV worst case.
3. **GAIN:** Remove the short between +S and -S, and insert a 1k Hz signal. At each gain, the level of the input signal should be set for a  $\pm$ 10V output signal (7.07V RMS). Monitor the output waveform on the oscilloscope for clipping and/or for slew-rate limiting. Calculate the gain for each gain-switch setting. Gain should be within  $\pm$ 2% of indicated value.
4. **CMRR:** (Bridge Excitation OFF) Connect the short between +S and -S, and apply 20V peak to peak from the shorted junction to common (-P) At 70Hz, the output voltage should be less than 0.2V peak to peak (-100 dB) and at 1k Hz it should be less than 0.7 peak to peak (-80 dB)
5. **FREQUENCY RESPONSE:** Set the signal generator to 1k Hz, gain to 1000, and apply an input signal level to bridge terminals -S and +S for a 20V peak to peak output. Increase the frequency until the output is down 3 dB (x0.707). Frequency should be greater than 100k Hz, with no slew rate limiting.
6. **LOAD TEST:** With the output at  $\pm$ 10V, connect 142 ohms (70mA) in parallel with 0.01 $\mu$ f across the amplifier's output. This simulates worst-case load. While scanning the passband frequencies, the output should attenuate less than 0.5 dB (-0.3 dB typical) and the waveform shall not be affected.
7. **OVERLOAD TESTS**

**BRIDGE EXCITATION:** Short circuit the bridge excitation terminals +P to -P. When the short is removed the bridge excitation voltage should return to its pre-short voltage level (make sure Bridge Excitation Switch is "ON").

**AMPLIFIER:** Short-circuit the amplifier output. When the short is removed, the unit shall recover to normal operation.
8. **EXCITATION VOLTAGE RANGE:** The excitation voltage shall vary from zero to +15VDC min as the excitation trimpot is adjusted from full counter-clockwise to clockwise. Reset to 5VDC.
9. **BRIDGE COMPLETION VALUE CHECK:** (1/4 bridge or 1/2 bridge mode). With the bridge excitation "OFF", measure the resistances between +P and -S, -P and -S, and -P and +S. Readings should be 120 ohms and 350 ohms respectively. Between +P and +S the resistance should be approximately 3 times the selected value (+S shorted to R).
10. **INTERNAL CALIBRATION:** Connect the full 120 ohm bridge to the bridge input connector. Set the bridge excitation to +5VDC, the gain to x1000, and the bridge mode to "FULL". Balance the bridge manually, and ground the CAL BNC. The output should shift about 2.5VDC.

11. **ATTENUATION VERNIER:** Turn attenuation vernier trimpot fully clockwise and note that the output gain is attenuated 10 dB. (3:1) Return to counter-clockwise position.
12. **MECHANICAL INSPECTION:** Check the module for conformance to outline specification and workmanship standards.
13. **CROSS TALK:** Set any channel with an input signal and gain setting that provides  $\pm 10V$ , 100k Hz at its output.

Set an adjacent channel to zero mode and its gain to 1000.

Measure the change in RMS noise from the 1k Hz to 100k Hz input signal. Should be less than 10mV peak to peak on the second channel. (-126 dB channel to channel).

## SECTION 7 SPECIFICATIONS

### DMD-519

<b>BRIDGE EXCITATION:</b>	0-15VDC front panel adjustable
<b>BRIDGE CONFIGURATIONS:</b>	front panel switch for 1/4, 1/2, and full bridge, and for 120 and 350 ohm gages
<b>INPUT/OUTPUT:</b>	1 input and 1 output per module
<b>GAIN:</b>	front panel switch 1, 2, 5, 10, 20, 50, 100, 200, 500, 1000, 2000, 5000, with vernier and zero front panel screw adjust
<b>FREQUENCY RESPONSE:</b>	DC to 100k Hz (-3 dB)
<b>OUTPUT:</b>	$\pm 10VDC @ 100mA$
<b>OUTPUT NOISE:</b>	5 $\mu V$ RMS referred to input (RTI), over DC to 100k Hz, at 1000 gain
<b>OUTPUT DRIFT:</b>	10 $\mu V$ DC RTI for 24 hours, after 1 hour warm up, at 1000 gain
<b>BRIDGE BALANCE:</b>	front panel screw adjustable
<b>REMOTE BRIDGE BALANCE:</b>	$\pm 2.5\mu V$ DC/V one remote switch performs balancing on all modules that have auto tare activated. Remote balance is activated via PCB switch
<b>BRIDGE SHUNT CALIBRATION:</b>	front panel switch (shunt resistor is internal to module)
<b>REMOTE SHUNT CALIBRATION:</b>	one remote switch closure on the rack performs shunt calibration on all channels

## **SPECIFICATIONS (Cont'd)**

### **DMD-519-BP**

<b>SIZE (H x W x D):</b>	7" x 19" x 20" (177.8 x 482.6 x 508 mm)
<b>POWER:</b>	115VAC @ 50/60 Hz, 2A slow-blow fuse installed, detachable 6 ft 18 gauge power cord
<b>CONNECTIONS:</b>	16 input signals use PTO6F10-6S; 16 output signals use BNC connector; 1 remote Cal uses BNC; 1 remote Balance uses BNC connector; 1 Excitation Adjust monitor per module uses BNC connector



## NOTES:

## NOTES:



## WARRANTY/DISCLAIMER

OMEGA ENGINEERING, INC. warrants this unit to be free of defects in materials and workmanship for a period of **13 months** from date of purchase. OMEGA's WARRANTY adds an additional one (1) month grace period to the normal **one (1) year product warranty** to cover handling and shipping time. This ensures that OMEGA's customers receive maximum coverage on each product.

If the unit malfunctions, it must be returned to the factory for evaluation. OMEGA's Customer Service Department will issue an Authorized Return (AR) number immediately upon phone or written request. Upon examination by OMEGA, if the unit is found to be defective, it will be repaired or replaced at no charge. OMEGA's WARRANTY does not apply to defects resulting from any action of the purchaser, including but not limited to mishandling, improper interfacing, operation outside of design limits, improper repair, or unauthorized modification. This WARRANTY is VOID if the unit shows evidence of having been tampered with or shows evidence of having been damaged as a result of excessive corrosion; or current, heat, moisture or vibration; improper specification; misapplication; misuse or other operating conditions outside of OMEGA's control. Components which wear are not warranted, including but not limited to contact points, fuses, and triacs.

**OMEGA is pleased to offer suggestions on the use of its various products. However, OMEGA neither assumes responsibility for any omissions or errors nor assumes liability for any damages that result from the use of its products in accordance with information provided by OMEGA, either verbal or written. OMEGA warrants only that the parts manufactured by it will be as specified and free of defects. OMEGA MAKES NO OTHER WARRANTIES OR REPRESENTATIONS OF ANY KIND WHATSOEVER, EXPRESS OR IMPLIED, EXCEPT THAT OF TITLE, AND ALL IMPLIED WARRANTIES INCLUDING ANY WARRANTY OF MERCHANTABILITY AND FITNESS FOR A PARTICULAR PURPOSE ARE HEREBY DISCLAIMED. LIMITATION OF LIABILITY: The remedies of purchaser set forth herein are exclusive, and the total liability of OMEGA with respect to this order, whether based on contract, warranty, negligence, indemnification, strict liability or otherwise, shall not exceed the purchase price of the component upon which liability is based. In no event shall OMEGA be liable for consequential, incidental or special damages.**

CONDITIONS: Equipment sold by OMEGA is not intended to be used, nor shall it be used: (1) as a "Basic Component" under 10 CFR 21 (NRC), used in or with any nuclear installation or activity; or (2) in medical applications or used on humans. Should any Product(s) be used in or with any nuclear installation or activity, medical application, used on humans, or misused in any way, OMEGA assumes no responsibility as set forth in our basic WARRANTY/DISCLAIMER language, and, additionally, purchaser will indemnify OMEGA and hold OMEGA harmless from any liability or damage whatsoever arising out of the use of the Product(s) in such a manner.

## RETURN REQUESTS/INQUIRIES

Direct all warranty and repair requests/inquiries to the OMEGA Customer Service Department. BEFORE RETURNING ANY PRODUCT(S) TO OMEGA, PURCHASER MUST OBTAIN AN AUTHORIZED RETURN (AR) NUMBER FROM OMEGA'S CUSTOMER SERVICE DEPARTMENT (IN ORDER TO AVOID PROCESSING DELAYS). The assigned AR number should then be marked on the outside of the return package and on any correspondence.

The purchaser is responsible for shipping charges, freight, insurance and proper packaging to prevent breakage in transit.

FOR **WARRANTY** RETURNS, please have the following information available BEFORE contacting OMEGA:

1. Purchase Order number under which the product was PURCHASED,
2. Model and serial number of the product under warranty, and
3. Repair instructions and/or specific problems relative to the product.

FOR **NON-WARRANTY** REPAIRS, consult OMEGA for current repair charges. Have the following information available BEFORE contacting OMEGA:

1. Purchase Order number to cover the COST of the repair,
2. Model and serial number of the product, and
3. Repair instructions and/or specific problems relative to the product.

OMEGA's policy is to make running changes, not model changes, whenever an improvement is possible. This affords our customers the latest in technology and engineering.

OMEGA is a registered trademark of OMEGA ENGINEERING, INC.

© Copyright 2002 OMEGA ENGINEERING, INC. All rights reserved. This document may not be copied, photocopied, reproduced, translated, or reduced to any electronic medium or machine-readable form, in whole or in part, without the prior written consent of OMEGA ENGINEERING, INC.

# Where Do I Find Everything I Need for Process Measurement and Control? **OMEGA...Of Course!**

*Shop online at [www.omega.com](http://www.omega.com)*

## **TEMPERATURE**

- ☑ Thermocouple, RTD & Thermistor Probes, Connectors, Panels & Assemblies
- ☑ Wire: Thermocouple, RTD & Thermistor
- ☑ Calibrators & Ice Point References
- ☑ Recorders, Controllers & Process Monitors
- ☑ Infrared Pyrometers

## **PRESSURE, STRAIN AND FORCE**

- ☑ Transducers & Strain Gages
- ☑ Load Cells & Pressure Gages
- ☑ Displacement Transducers
- ☑ Instrumentation & Accessories

## **FLOW/LEVEL**

- ☑ Rotameters, Gas Mass Flowmeters & Flow Computers
- ☑ Air Velocity Indicators
- ☑ Turbine/Paddlewheel Systems
- ☑ Totalizers & Batch Controllers

## **pH/CONDUCTIVITY**

- ☑ pH Electrodes, Testers & Accessories
- ☑ Benchtop/Laboratory Meters
- ☑ Controllers, Calibrators, Simulators & Pumps
- ☑ Industrial pH & Conductivity Equipment

## **DATA ACQUISITION**

- ☑ Data Acquisition & Engineering Software
- ☑ Communications-Based Acquisition Systems
- ☑ Plug-in Cards for Apple, IBM & Compatibles
- ☑ Datalogging Systems
- ☑ Recorders, Printers & Plotters

## **HEATERS**

- ☑ Heating Cable
- ☑ Cartridge & Strip Heaters
- ☑ Immersion & Band Heaters
- ☑ Flexible Heaters
- ☑ Laboratory Heaters

## **ENVIRONMENTAL MONITORING AND CONTROL**

- ☑ Metering & Control Instrumentation
- ☑ Refractometers
- ☑ Pumps & Tubing
- ☑ Air, Soil & Water Monitors
- ☑ Industrial Water & Wastewater Treatment
- ☑ pH, Conductivity & Dissolved Oxygen Instruments