

TRICITY BENDIX

OPERATING & INSTALLATION
INSTRUCTIONS

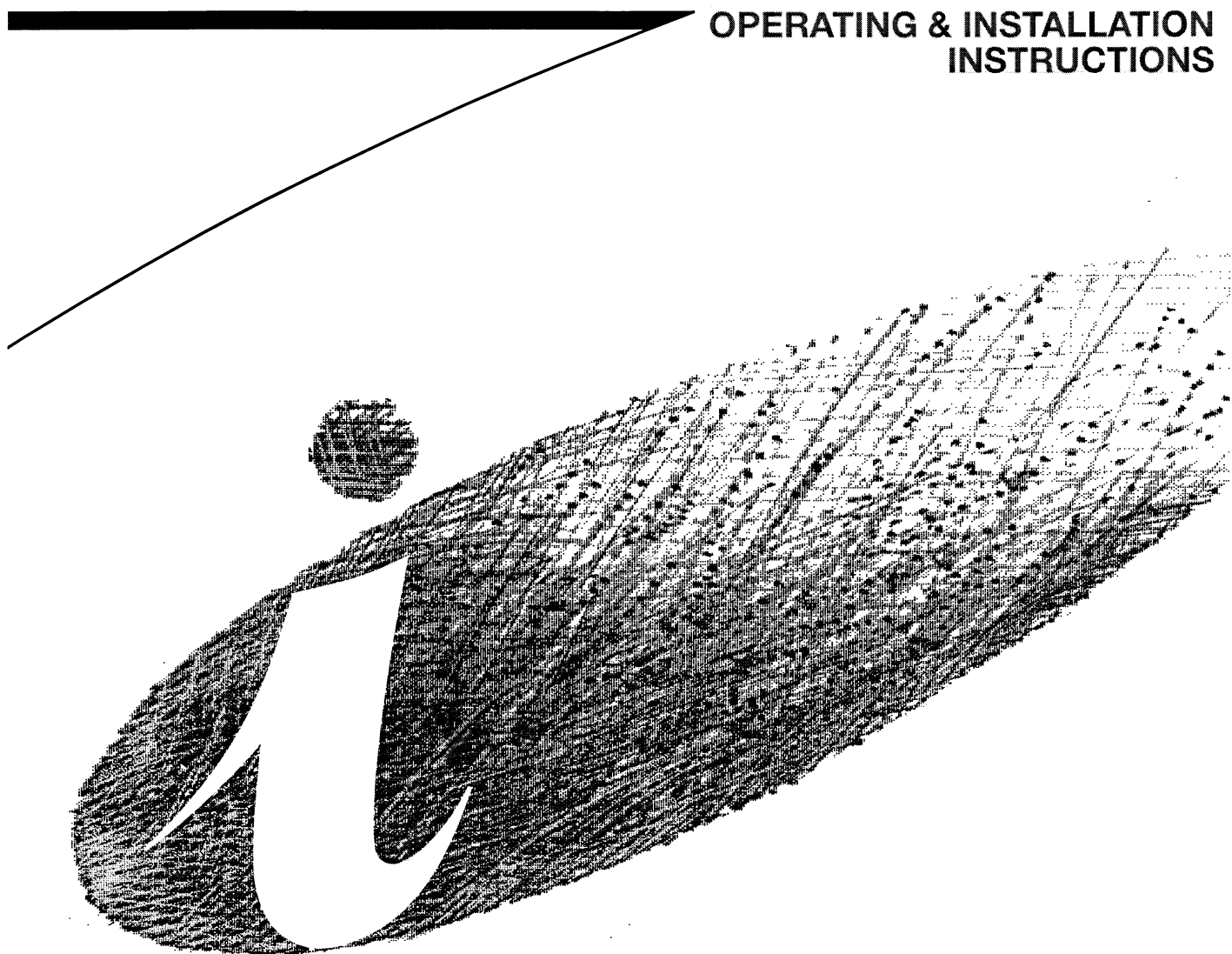

ELECTRIC COOKER

SE545P

Table of contents

Important Warnings	4	FOR THE INSTALLER	32
YOUR COOKER	6	TECHNICAL INFORMATION	34
THE OVEN CAVITY	7		
Oven accessories	8		
The cooking levels	8		
THE ELECTRONIC PROGRAMMER	9		
BEFORE THE FIRST USE	11		
HOW TO USE YOUR COOKING HOB ...	12		
OVEN CONTROLS	13		
The function selector	13		
The temperature control	13		
The neon indicator lights	13		
COOKING FUNCTIONS	14		
HINTS AND TIPS : THE HOB	21		
HINTS FOR SUCCESSFUL COOKING	22		
COOKING GUIDE	23		
MAINTENANCE AND CLEANING	24		
CLEANING AND CARE	26		
SOMETHING NOT WORKING	28		
SERVICE AND SPARE PARTS	29		
GUARANTEE CONDITIONS	30		

Guide to use the Instruction Book

This section explains standard symbols used throughout to make it easier for the User to find information i.e



Safety instructions

1.2.3. Step by step instructions for an operation



Hints and tips



Environmental information



Important Safety Instructions

These warnings are provided in the interest of safety. You **MUST** read them carefully before installing or using the appliance. Your safety is of paramount importance. If you are unsure about any of the meanings of these **WARNINGS**, contact the Customer Care Department.

Installation

- The cooker must be installed according to the instructions supplied. Any electrical work must be undertaken by a qualified electrician/competent person.
- This cooker is heavy and care must be taken when moving it. Do not try to move the appliance by pulling the door handle.
- Remove **all packaging**, both inside and outside the cooker, before using the appliance. After installation, please dispose of the packaging with due regard to safety and the environment.
- **It is dangerous** to alter the specifications or modify the appliance in any way.

During Use

- This cooker has been designed for cooking edible foodstuffs only and **must not** be used for any other purposes.
- Never line any part of the cooker with **aluminium foil**. Do not allow heatproof cooking material, e.g. roastings bags, to come into contact with oven elements.
- **Never** place plastic or any other material which may melt in or on the cooker.
- **Do not** place sealed cans or aerosols inside the cooker. They may explode if they are heated.
- **Do not** hang towels, dishcloths or clothes from the oven or its handle. They are a **safety hazard**.
- **Do not** use this cooker if it is in contact with water and never operate it with wet hands.
- Always cook with the oven door closed.
- Take **great care** when heating fats and oils as they will ignite if they become too hot.
- **Always** use oven gloves to remove and replace food in the oven. Similarly always use oven gloves to remove and replace the grill pan handles, before and after grilling.
- **Always** remove the grill pan handles when grilling.
- Ensure that you **support** the grill pan when removing it from the oven.
- **Take care** to follow the recommendations given for tending the food when grilling.
- **Always** stand back from the oven when opening the oven door, to allow any build-up of steam or heat to release.
- Stand clear when opening the drop down oven door. **Do not** allow it to fall open – support the door using the door handle, until it is fully open.
- Ensure that all control knobs are in the **OFF** position when not in use.
- **Do not** leave cookware containing foodstuffs, e.g. fat or oil in or on the oven in case it is inadvertently switched **ON**.
- When using other electrical appliances near the cooker, ensure the cable does not come into contact with the hot surfaces of the cooking appliance.
- Never leave anything on the cooking hob. A fire could be caused if it is accidentally switched on.
- Do not drop anything on the ceramic surface. A sudden shock such as a salt pot dropping can crack or break the glass.
- Do not stare at the halogen lamps in the cooking elements (if your appliance is equipped with them).
- When the oven door is open:
 - do not put any heavy loads on it,
 - make sure that children cannot climb on the door or sit on it.
- Do not leave the door open if the oven is still switched on or if it is still warm, to avoid damaging the controls of your appliance.
- Never leave your cooking hob switched on if there is nothing on it.
- Before you use your appliance for the first time, warm it up once without cooking anything. Make sure that the room is sufficiently well ventilated (controlled mechanical ventilation) and that the ventilation is switched on or the window is open.
- The appliance gets hot when it is in use. Do not touch heating elements inside the oven.
- Residual heat indicators come on to inform you that elements are switched on or are still warm. Make sure that young children keep away from the appliance until these lights go off.
- Never leave anything on the hob while using the cooking zones (cloths, aluminium foil, etc.).

- Do not store cleaning products or inflammable products in the drawer.
- Make sure that there is nothing underneath the drawer, so that it will slide properly.
- The use of unsuitable cleaning products causes scratches, attacks the surface or may discolour the surface. This is why it is essential to use only SPECIAL CERAMIC COOKING HOBS cleaning products. Never use sharp objects to remove spills.
We cannot be responsible for incorrect use of your cooker or a failure to respect safety rules. Also respect cleaning instructions at all times.
- Other than the accessories supplied with your cooker, only use dishes, cake moulds, etc., that are heat resistant (follow the manufacturer's instructions).

Child Safety

- This appliance is designed to be operated by adults. Young children **must not** be allowed to tamper with the controls or play near or with the appliance.
- Accessible parts, especially around the grill area, become hot when the cooker is in use. Children should be **kept away** until it has cooled.

Maintenance and Cleaning

- **Only** clean this oven in accordance with the instructions.
- The cooker should be kept clean at all times. A build-up of fats or other foodstuffs could result in a fire, especially in the grill pan.
- For safety reasons, do not clean the appliance with a steam or high-pressure cleaner.
- Always switch off at the electrical supply prior to carrying out any cleaning or maintenance work.

Service

- You must not attempt to repair the appliance yourself. Repairs carried out by inexperienced persons may cause injury or serious malfunctioning. Refer to your local TRICITY BENDIX Service Force Centre. Always insist on genuine TRICITY BENDIX spare parts.

Disposal of an old appliance

- Make the appliance unusable, by cutting off the cable, and remove any door catches, to prevent small children being trapped inside.

It is most important that this instruction book should be retained with the appliance for future reference. Should the appliance be sold or transferred, always ensure that the book is left with the appliance in order that the new owner can get to know the functions of the appliance and the relevant warnings.

YOUR COOKER

Control panel

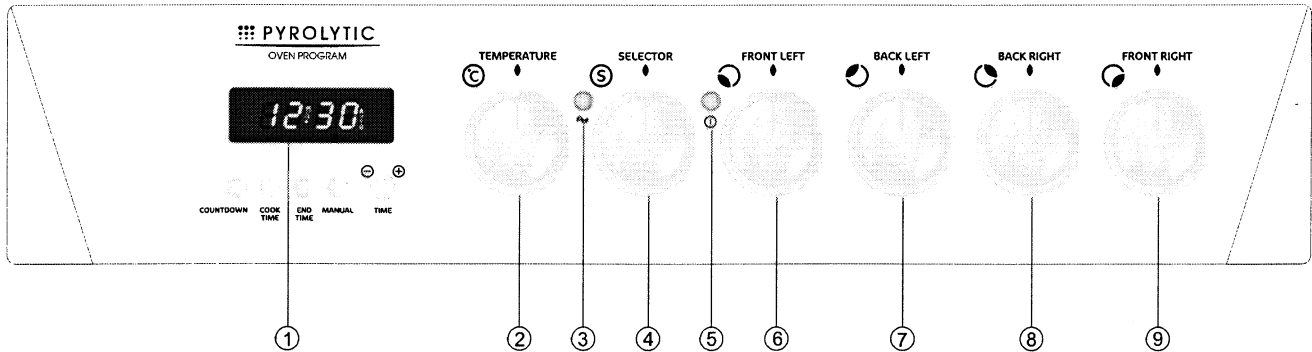

- ① Electronic timer
- ② Oven temperature control
- ③ Temperature indicator light
- ④ Oven function selector
- ⑤ Hob and oven on indicator light
- ⑥ to ⑨ Cooking zone controls

Cooking hob

Highlight (radiant) cooking zone
1,20 kW

Highlight (radiant) cooking zone
2,30 kW

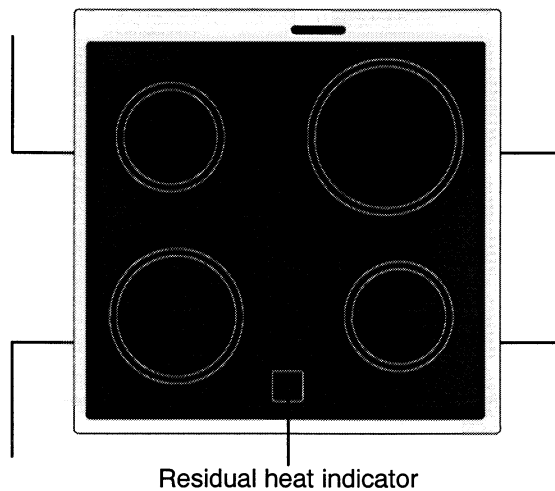

Highlight (radiant) cooking zone
1,80 kW

Highlight (radiant) cooking zone
1,20 kW

THE OVEN CAVITY

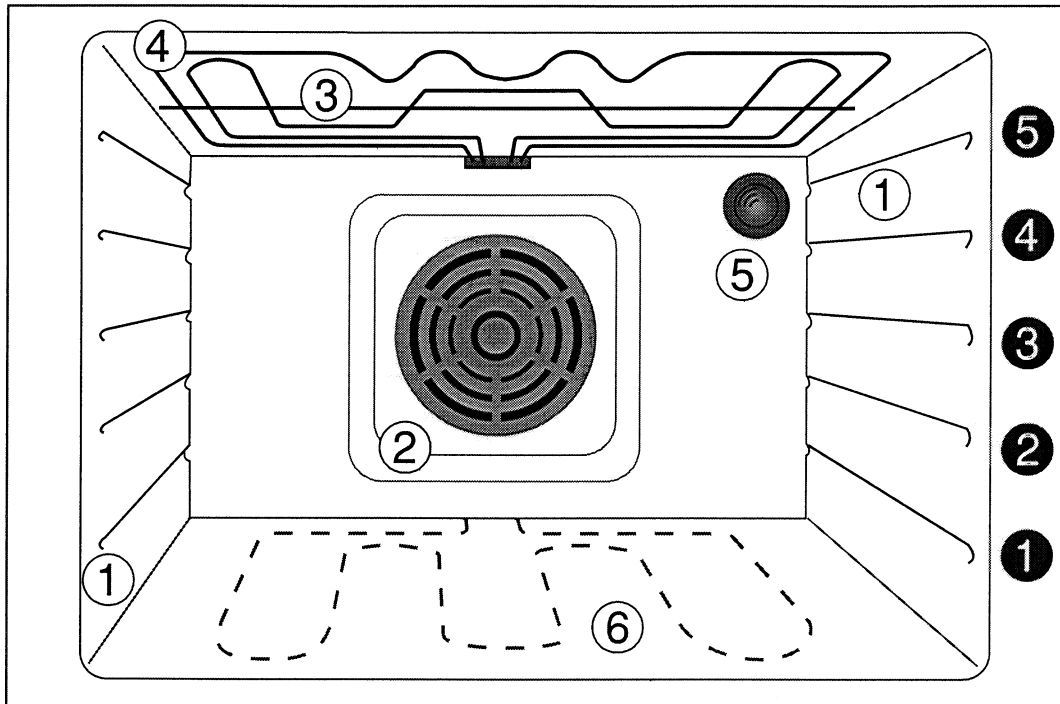

① Shelf runners

② Fan

③ Roof

④ Grill elements

⑤ Oven light

⑥ Lower heating element (under the base panel)

① to ⑤ Shelf levels

Oven accessories



In addition to the accessories supplied with your cooker, only use ovenware that is ovenproof to very high temperatures (follow manufacturers' instructions).

Your cooker is equipped with :

- 2 wire shelves
- 1 grill pan

The wire shelves

Dishes, cake tins and so on can be placed on these shelves.

It can be used high side up or low side up to adjust the position of your dishes in relation to the source of heat.

For very heavy dishes (4 kg or more), always use the shelf high side up.

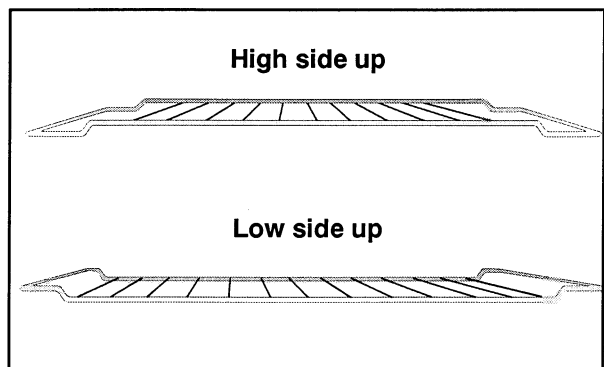
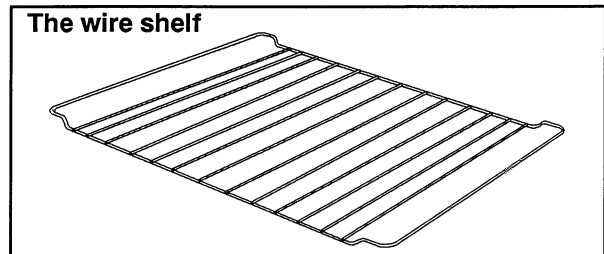

The grill pan

The grill pan is supplied with 1 grid and 2 handles.

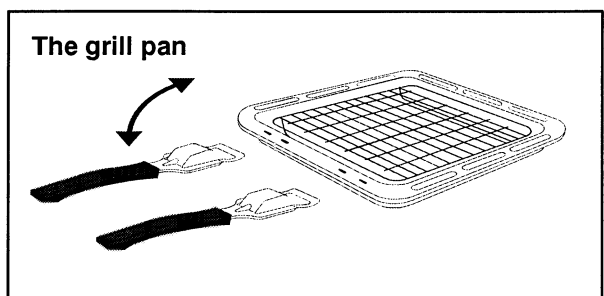

The cooking levels

The oven has five shelf levels which are counted from 1 to 5 (from the bottom upwards).

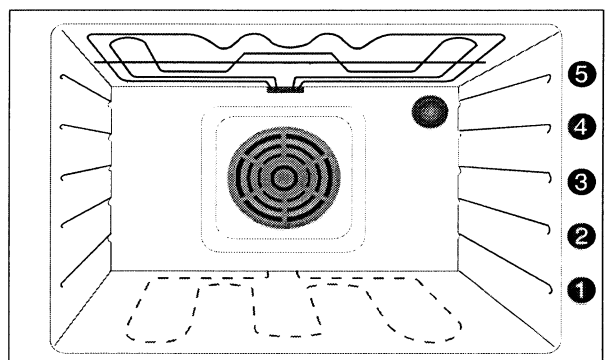

THE ELECTRONIC PROGRAMMER

Symbol displayed when a programme is in operation

Symbol displayed when the child safety is in operation

Auto symbol : indicates the automatic operation

1 st button : time setting, minute minder, alarm switch off

2 nd button : cooking or pyrolytic cleaning duration

3 rd button : cooking or pyrolytic cleaning end

Time setting knob

4 th button : manual function

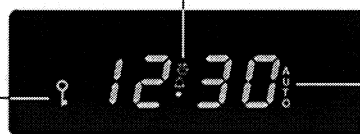

To set the time of day

Press buttons "COUNTDOWN" and "COOK TIME" and at the same time turn the time setting knob until the correct time of day is displayed.

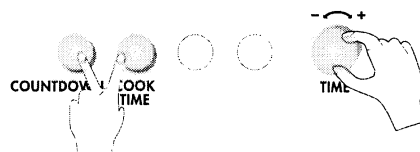

Manual function

Press button "MANUAL" to set the oven for manual function.



To set the minute minder :

Press button "COUNTDOWN" and at the same time turn the time setting knob until the duration time is displayed (maximum 23 hours, 59 minutes). After a few seconds the time of day will show in the display.

To check the number of minutes remaining, press the "COUNTDOWN" button. At the end of the timed period an alarm will sound. To switch off the alarm press button "COUNTDOWN".

The minute minder does not stop the cooking when the duration has elapsed. To stop the oven set the temperature control on ● and the function selector on 0.



To set the timer to switch off only

(Immediate start - Automatic stop)

This is useful if you want to begin cooking immediately but have the oven switched off automatically.

1. Set the function selector knob and the temperature control knob on the required settings.
2. Place the dish in the oven.
3. Press button "**COOK TIME**" and, at the same time, turn the time setting knob until the required cooking duration is displayed.

At the end of the cooking time the oven will switch off, an alarm will sound.

Turn the function and temperature knobs on the Stop position (temperature control on ● and function selector on 0).

To switch off the alarm press button "**COUNTDOWN**".

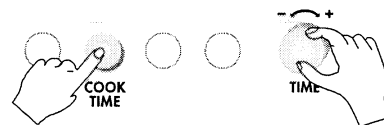

To set the timer to switch the oven on and off

(Deferred start - Automatic stop)

1. Ensure the clock is showing the right time of day.
2. Carry out steps 1, 2 and 3 as explained in "To set the timer to switch off only".
3. Press button "**END TIME**" and at the same time turn the time setting knob until the end cooking time is displayed.

At the end of the cooking time the oven will switch off, an alarm will sound.

Turn the function and temperature knobs to the off position (temperature control on ● and function selector on 0).

To switch off the alarm press button "**COUNTDOWN**".

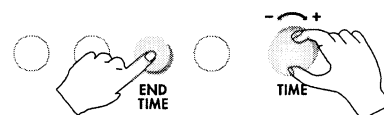
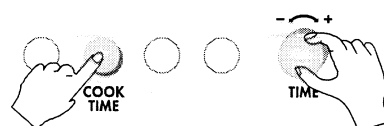

To cancel a programme

1. Press button "**COOK TIME**" and, at the same time, turn the time setting knob until the cooking duration is set on "0".
2. If the end cooking time has been set too, press button "**END TIME**" and at the same time, turn the time setting knob until the end cooking time is set on "0".

Child safety

To prevent a child switching on the oven during your absence, your oven is equipped with a "locking system".

- When the oven is switched off press at the same time the buttons "**COUNTDOWN**" and "**COOK TIME**" : "On" is displayed.
- Immediately turn the time setting knob clockwise with one step only : "Of" is displayed. The child safety symbol is displayed after a few seconds.
- To deactivate the child safety, repeat this operation. The child safety symbol disappears : you can now use your oven.

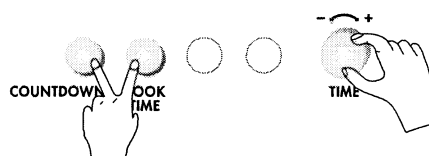

HOW TO USE YOUR COOKING HOB

Highlight (radiant) cooking zones

Cooking zones turn red within 10 seconds after they have been switched on. They become red and then dark again while they are in use (refer to the "Cooking Guides" chapter).

Each cooking zone is protected by a temperature limiter that switches it off if it overheats (for example operation with nothing on it).

To switch a zone on:

- Turn the knob towards the right or the left.
- Put the knob to the maximum position for a few seconds, and then move it to the selected setting and the "On" light comes on.

To switch a zone off:

- Turn the knob to the "0" position.

The "On" light goes off, unless another zone is switched on.

The "hob on" light

The "On" light comes on when you turn one of the cooking zone knobs. It goes off when all zones are switched off.











Safety

- Each zone has a residual heat light (safety indicator). This light comes on when the element is hot. When you switch a zone off, the light remains on as long as there is a risk of the heat released by the element causing a burn (even if the zone is no longer red). This will not indicate residual heat if there is a power cut.
- We recommend that young children should not be allowed to come close to the appliance until these lights have all gone off.
- Never put anything on the cooking hob that could melt (utensils with plastic handles, aluminum foil, food containing sugar, etc.); clean immediately following an accident.
- If the hob is damaged or cracked, disconnect the cooker from the electricity supply and contact your local Service Force Centre.
- Never leave a cooking zone switched on if there is no pan on it.

OVEN CONTROLS

The function selector

To obtain the desired cooking mode, turn the function selector :

- Oven light 
- Fan oven 
- Thermal grilling 
- Roasting meat 
- Preheating 
- Conventional oven 
- Grill 
- Pyrolytic cleaning 

Once a function has been selected, an appropriate temperature must be set for the oven to heat up.

To switch off the oven turn the temperature control to ● and then the function selector to 0.

The oven light comes on as soon as the function selector is turned. The light remains on during cooking.

The temperature control

The neon indicator lights

Oven on

The indicator light comes on when the appliance is switched on, and goes out when the function selector is in the Off position (0).

Temperature

The indicator light comes on while the oven is pre-heating and goes out when the required temperature is reached. It switches on and off during cooking to indicate that the temperature is being maintained.

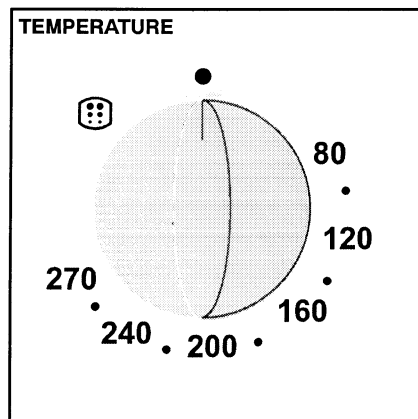
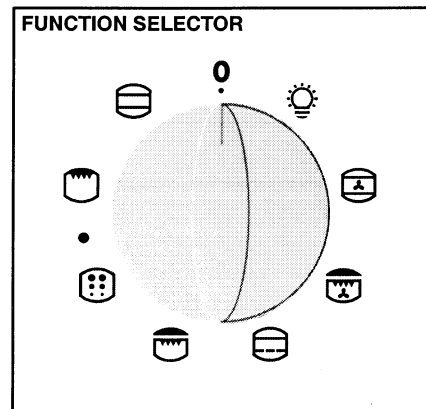

After use ensure the knobs are in the Off-position (temperature control to ● and function selector to 0).

COOKING FUNCTIONS

Fan oven

Dishes can be cooked on **one or several levels** using the fan oven. The circulation of hot air produces an even cooking temperature. Fan oven cooking is ideal for all types of dishes.

The advantages of fan oven

Faster preheating :

- As the fan oven quickly reaches temperature, it is not usually necessary to preheat the oven although you may find that you need to allow an extra 5-7 minutes on cooking times.

Lower temperatures :

- Fan oven cooking generally requires lower temperature than conventional cooking. Follow the temperatures recommended in the charts or remember to reduce temperatures by about 20-25° C for your own recipes which use conventional cooking.

Even heating for baking :

- The fan oven has uniform heating on all shelf positions. This means that batches of the same food can be cooked in the oven at the same time. However, the top shelf may brown slightly quicker than the lower one. This is quite usual. There is no mixing of flavours between dishes.

Cooking frozen dishes

- With fan oven cooking, you can put frozen food (ready-cooked food, meat, chicken) straight into the oven **without thawing**. There is no need to preheat the oven in this case : simply reduce the temperature slightly at the start of cooking.

With commercial frozen foods, refer to the cooking instructions for conventional oven cooking on the packaging.

How to proceed ?

1. Turn the function selector to  and then the temperature control on the required temperature.

Refer to cooking guides.

Cooking the same type of food on two levels

Which accessories to use ?

In most cases, use wire shelves on runners ① and ③.

See cooking charts.

Cooking different types of dishes on two levels

The multi-level position makes it possible for you to cook a complete meal at once. To do so, be guided by the following recommendations :

- The various dishes should require similar temperatures.
- Overall cooking time should be the same as the longest cooking time required.
- Different dishes may be placed inside or removed from the oven at different times. This depends on the cooking time required for each of them, and possibly on the order in which they are to be served.
- Take care not to open the oven door while another dish could be adversely affected (for instance, opening the door could prevent a cake from rising).
- Remember that certain dishes rise in cooking, so leave enough space between shelves.
- Meat and poultry should preferably be placed on shelf ① so as not to spit on other dishes.

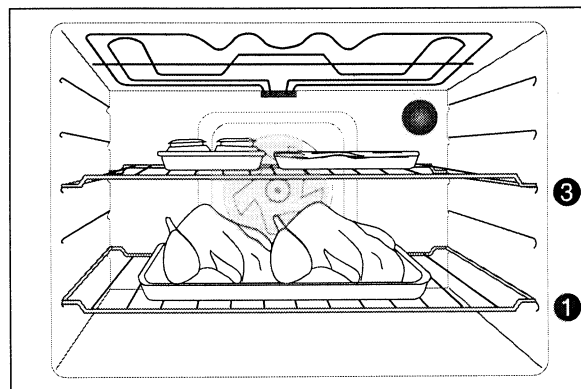
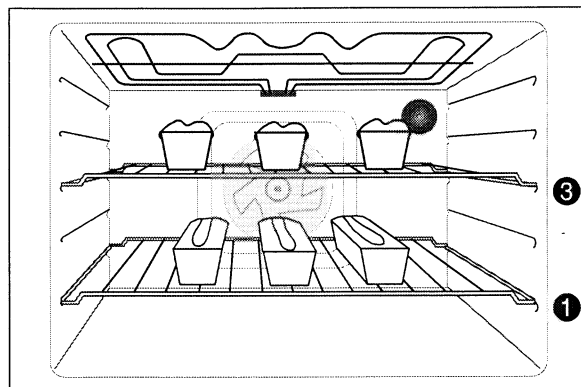



Defrosting

The fan oven operates without heat and circulates the air, at room temperature, inside the oven. This increases the speed of defrosting. However, please note that the temperature of the kitchen will influence the speed of defrosting.

This function is particularly suitable for delicate food which could be damaged by heat, e.g. cream filled gateaux, iced cakes, pastries, bread and other yeast products.

How to proceed ?

1. Turn the oven function selector to .
2. Ensure the temperature control knob is in the Off position .

Hints and tips

- Cover food with a lid, aluminium foil or plastic film to prevent drying out during defrosting.
- **ALWAYS COOK THOROUGHLY IMMEDIATELY AFTER THAWING.**
- Frozen food should be placed in a single layer when ever possible and turned over half way through the defrosting process.
- Only joints of meat and poultry up to 2 kg (4 lb.) are suitable for defrosting in this way.

Thermal grilling

 **Thermal grilling is used with the door closed. Never leave the grill unattended when cooking.**

Thermal grilling offers an alternative method of cooking food items normally associated with conventional grilling. The grill element and the oven fan operate alternately, circulating hot air around the food. The need to check and turn the food is reduced. Thermal grilling helps to minimize cooking smells in the kitchen.

With the exception of toast and rare steaks, you can thermally grill all the foods you would normally cook under a conventional grill. Cooking is more gentle, therefore food generally takes a little longer to cook with thermal grilling compared with conventional grilling. One of the advantages is that larger loads can be cooked at the same time.

The pre-heating is not necessary for this cooking method.

How to proceed ?

Grilling

1. Prepare the food to be grilled.
2. Place the food directly on the grill pan grid.
3. Set the function selector to  and then the temperature control to the required temperature (see cooking guides).
4. Place the grill pan on runner ③ or ④ depending on the thickness of the food being grilled.
5. When one side is browned, turn the meat over without piercing it to avoid losing juices. For poultry and sausages, piercing before cooking is recommended.
6. Cook the other side.
7. Season when cooking has finished.

Cooking time depends on the thickness of the meat and not on its weight.

Browning toppings

1. Set the function selector to  and then the temperature control to the required temperature (see cooking guide).
2. Place the dish containing the food on the shelf. The closer the food is to grill element the faster the browning will occur.
3. Leave the dish under the grill for a few minutes until the food is bubbling and browned.

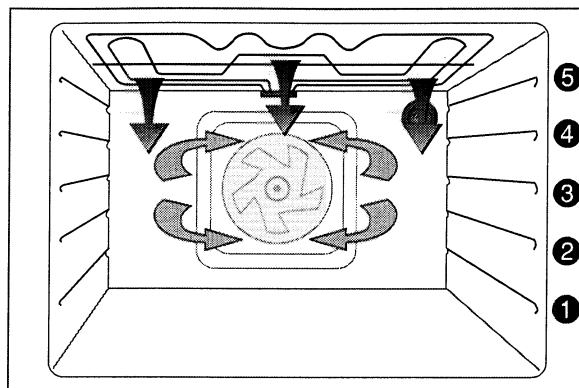



Roasting meat

This position is ideal for cooking meat.

Spitting of fat, smoking and odours are considerably reduced.

Meat is evenly browned and tender, while the oven stays cleaner longer.

How to proceed ?

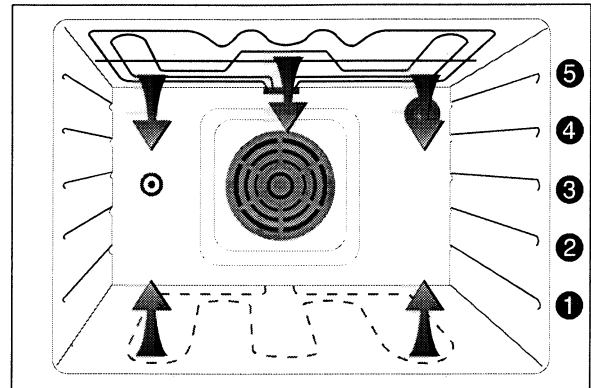

1. Preheat the oven by putting the selector in the position  and then the thermostat on the temperature required.
2. Place the meat in the oven, then, without changing the temperature position, place the selector in the  position, for roasting meat.



Preheating

This function is suitable for preheating the oven when you have to roast meat (see cooking guide).

How to proceed ?

1. Turn the function selector to  and the temperature control knob to the required temperature (see cooking guides). The temperature control indicator will light up and remain lit until the required temperature has been reached.
2. When the temperature indicator light goes out, turn the function selector to the roasting meat position .
3. Place the dish in the oven.

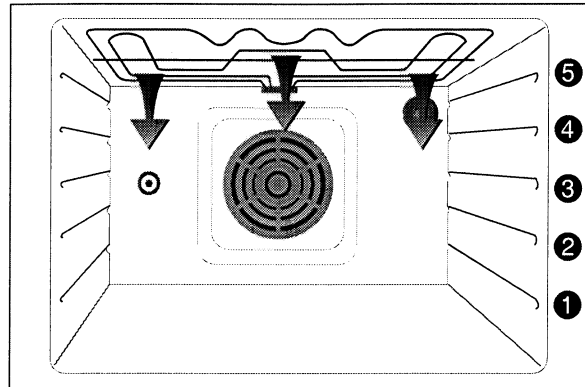

Conventional oven

Ideal for all types of cooking, especially baking, fish, terrines and vegetable based dishes.

The oven should be pre-heated.

To ensure even heat distribution, we recommend you cook on one level only.

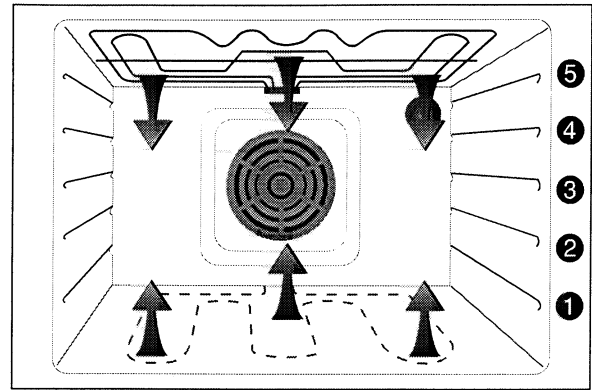

How to proceed ?

1. Pre-heat the oven by setting the function selector to  and the temperature control to the required temperature. See the cooking guide.

Pre-heating time :

- Approximately 6^{1/2} minutes to reach 150°C.
- Approximately 9 minutes to reach 200°C.

2. Place the dish in the oven as soon as the temperature indicator light goes off.

Grill



Use the grill with the oven door closed to prevent damage to the control panel.

Never leave the grill unattended when cooking.

Preheat for 3 to 5 minutes.

This cooking mode is ideal for cuts of meat (pork chops, sausages,...) which stay tender and juicy, for toasting or for browning toppings on prepared dishes, preferably hot (e.g. macaroni cheese).

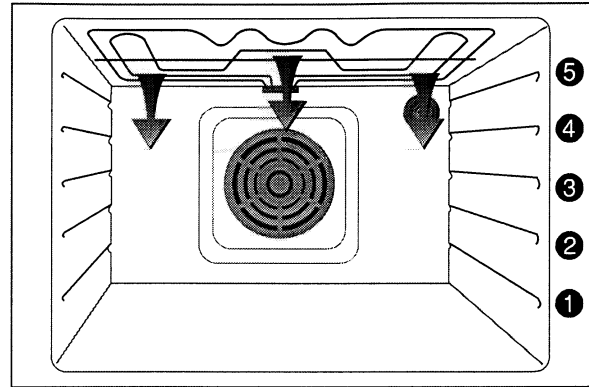

How to proceed ?

Grilling

1. Prepare the food to be grilled.
2. Set the function selector to  and then the temperature control to the required temperature (see cooking guides).

When grill element has become red :

3. Put the grill pan on the shelf. Use shelf level ③ or ④ depending on the thickness of the food being grilled.
4. When one side is browned, turn the meat over without piercing it to avoid losing juices. For poultry and sausages, piercing before cooking is recommended.
5. Cook the other side.
6. Season when cooking has finished.

Cooking time depends on the thickness of the meat and not on its weight.

Browning toppings

1. Set the function selector to  and then the temperature control to the required temperature (see cooking guide).
2. Place the dish containing the food on the shelf. The closer the food is to grill element the faster the browning will occur.
3. Leave the dish under the grill for a few minutes until the food is bubbling and browned.

HINTS AND TIPS : THE HOB

Safety

- The ceramic cooking hob of your cooker is insensitive to temperature variations and resists minor shocks. However, it is not unbreakable. Do not use your hob as a countertop and do not drop small objects (spice jars, sharp tools, etc.), on it.
- If your hob is damaged (spalling, crack, etc.) by a shock, disconnect the cooker from the electricity supply and contact your local Service Force Centre.
- Never heat an empty pan on the ceramic hob.
- Never cook food on the cooking zone or in aluminum foil directly, since this could cause irrecoverable damage to your hob.
- Never put anything made of plastic onto the hot surfaces.

Practical recommendations

- Cover your pots and pans whenever you can, depending on your recipe, this will save energy.
- Put the knob back to the "0" position before the end of cooking. You can finish cooking using the residual heat in the cooking zone.
- You can take advantage of the residual heat in the cooking area to keep your dishes warm, as long as the light is on.
- Put the knob to a lower setting a few minutes before boiling starts to prevent spills (milk, oil, sauce, etc.). Do not overfill your receptacles.
- Clean any large spills immediately (milk, rice water or water for pasta) then finish cleaning when the cooking hob is only slightly warm, or is cold.

Choice of saucepans and frying pans

- Always choose a pan appropriate for the size of the zone being used:
 - 14 to 16 cm diameter for the front right and the back left elements.
 - 18 to 22 cm diameter for the front left and back right elements.
- All pans used on traditional electric hot plates can also be used on the ceramic hob, provided that they have a perfectly flat bottom. Do not use saucepans made of aluminum or an enamel metal with a thin bottom; they could become deformed, thus reducing the cooking efficiency.
- Cast iron pans (for example casseroles) are particularly suitable for use on a ceramic hob, but the base of these pans is often rough.
- Do not slide pans across the cooking surface, lift them before moving them.
- Keep the bases of pans clean and dry, since dirt incrustated on the bottom can scratch the glass surface.

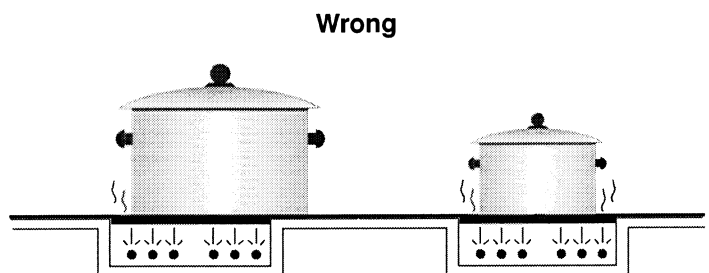
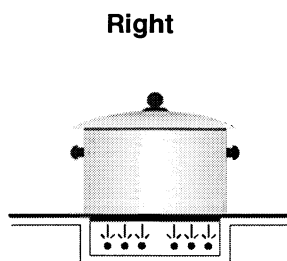

HINTS FOR SUCCESSFUL COOKING

Choice of ovenware

The thickness, conductivity and colour of ovenware affect the cooking results.

- A) Aluminium, earthenware, oven glassware and aluminium with a non-stick interior **reduce** cooking and base browning. These materials are recommended for light, soft textured cakes and roasts.
- B) Enamelled cast iron, anodized aluminium, zinc-plated iron, porcelain, aluminium with a non-stick interior and coloured exterior **increase** cooking and base browning. These materials are recommended in particular for tarts, quiches and crispy baking that should be browned beneath as well as on top.

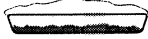
If you see	What to do ?
<p>Top too dark Bottom too light not cooked enough</p> 	<p>Use a tin or dish type B or place in lower runner</p>
<p>Top too light Bottom too dark overcooked</p> 	<p>Use a tin or dish type A or place in higher runner</p>

During cooking, certain dishes increase in volume, so remember to choose a container big enough : ideally, the uncooked dish should take up only two thirds of the container, leaving the upper third free for expansion.

To avoid excessive spitting, use high-sided dishes for roasting meat and poultry, or ovenproof glass roasting trays with a lid, appropriate to the size of the joint.

Condensation and steam

When food is heated it produces steam in the same way as a boiling kettle. The oven is vented to allow some of this steam to escape. However, always stand back from the oven when opening the door to allow any build up of steam or heat to release.

If the steam comes into contact with a cool surface on the outside of the oven, e.g. a trim, it will condense and produce water droplets. This is quite normal and is not caused by a fault on the oven.

To prevent discolouration, regularly wipe away condensation and also soilage from surfaces.



Practical tips

- Pierce the skin of poultry or sausages with a fork before cooking, to avoid the skin swelling and bursting with the heat.
- Leave as little fat as possible around joints of meat to avoid spitting and reduce the fat content.
- For tender joints of meat, turn halfway through cooking and add a little hot water to the dish to produce a tasty gravy and reduce spitting onto the walls of the oven.
- Do not exceed the temperature settings recommended in the cooking guide for meat.

To save energy







- Cook several dishes one after another, if possible, to save the energy needed to pre-heat the oven each time. Whenever possible, do not hesitate to cook 2 or 3 cakes or tarts, for example, at the same time.

COOKING GUIDES

The preheating of the oven is necessary for following cooking settings :

For cooking setting  preheating mode  time : approx. 6 minutes to reach 150°C
time : approx. 9 minutes to reach 200°C

For cooking setting  preheating mode  time : approx. 15 minutes to reach 200°C

Dish	Cooking	Shelf level (runner)	Temperature selector	Cook time (minutes)
Small cakes (2 x 12)		2 and 4	160°C	23
Scones (2 x 12)		2 and 4	210°C	6
Victoria sandwich		1 and 3	160°C	28
Rich fruit cake		2	140°C	120
Apple pie		2 and 4	190°C	35
Bread loaves (8 x 1lb)		1 and 4	200°C	25

Only your experience will enable you to determine the correct settings for your personal cooking needs. The temperatures are intended as a guide only. It may be necessary to increase or decrease the temperature to suit individual requirements.

MAINTENANCE AND CLEANING

Cleaning the hob

Ensure the hob is cool and that all control knobs are in the off position before cleaning.

Clean the hob before each use, to ensure that nothing will burn onto the ceramic hob.

Never use aggressive or abrasive agents, such as oven sprays, stain or rust removers, scouring powders, or sponges with an abrasive effect.

Special cleaning agents and ceramic hob scrapers are available from your local Service Force Centre.

Cleaning after each use

Slight, non burnt soilage can be wiped off with a damp cloth. Burnt soilage has to be removed with a scraper. Afterwards wipe off the ceramic hob with a damp cloth, and clean with a ceramic hob cleaning agent.

Stain removal

Light metallic stains (aluminium residues) can be removed from the cooking zone with a ceramic hob cleaning agent when cool.

Sugar solutions, food stuffs with a high sugar content must be removed immediately with a scraper. If this type of soilage is not removed immediately it can cause irreparable damage to the ceramic surface.

When the surface has cooled wipe over with a damp cloth and clean with a ceramic hob cleaning agent.

Before using any detergent or cleaning agent on the ceramic top, ensure they are recommended by the manufacturer for use on ceramic hobs.

Do not apply any cleaning agents to hot cooking zones. Ensure any residues are wiped off before the cooking zones are used again.

Control panel and knobs

Use a moist sponge dampened with soapy water. Then rinse and dry thoroughly.

Door, drawer and sides

Use a wet sponge to which a mild detergent has been added. Rinse and dry thoroughly.

Never use abrasive products.

If a chemical cleaner proves inadequate	Check whether the use of a scraper is more effective.
. when dark stains occur	If the use of a scraper and a ceramic hob cleaner proves unsuccessful, your hob surface may have been damaged by using unsuitable cleaning agents, or by pan bases with a scouring effect. This will not impair the efficiency of your ceramic hob.
. when metallic discolourations appear on the cooking zone	Pots and pans with unsuitable bottoms, or unsuitable cleaning agents have been used. The discolourations can only be removed with considerable effort, using a ceramic glass cleaner.
. when the surface shows scratches	These may be caused by scraping or melted on objects and cannot be removed. This will not impair the efficiency of your ceramic hob.

Replacing the oven light



Ensure the cooker is disconnected from the electrical supply before changing the bulb.

The 25 W - E14 (230/240 V) screw-in bulb is a **special “heat-resistant” bulb** capable of withstanding temperatures up to 300°C. Replacement bulbs are available through your local Service Force Centre.

The bulb is located at the back innerside of the oven and can be reached from inside the oven.

To replace the bulb :

1. Unscrew the bulb protection cover (turn anti-clockwise).
2. Unscrew the bulb anti-clockwise.
3. Screw in a new bulb.
4. Screw in the bulb protecting cap carefully.

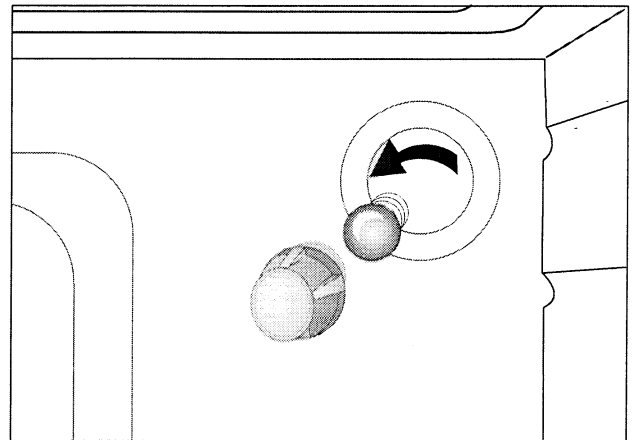

CLEANING AND CARE

Cleaning of the pyrolytic enamel oven

The principle

The walls of the oven are made of special high temperature enamel which is shiny in appearance and smooth to the touch.

During the pyrolytic cleaning, the temperature of the oven reaches approximately 500°C. The food and grease splatters are carbonised and wiped away as ash residue when the interior is completely cold. Smoke is filtered out by a catalyser.

The safety

The pyrolytic cleaning is perfectly safe : a safety lock prevents any accidental opening of the door as soon as the temperature in the oven approaches 300°C.

Beyond 300°C, the door remains locked even if the pyrolysis cycle is interrupted (by a power failure or deliberately). You will not be able to open the door again until the oven has cooled.

During the cleaning cycle, a fan operates. Ventilation continues even after the cleaning cycle until the oven has cooled sufficiently.

Pyrolytic cleaning can only be carried out under the control of the programmer.

Regular maintenance

After cooking, remember to wipe off any splashes or stains with a damp sponge.

For better visibility when cleaning the oven, set the selector to  position.

In the event of spills on the bottom panel, soak the panel but do not scrape it and avoid abrasive cleaning products that risk damaging surfaces (enamel, varnish, lacquer).

Periodic maintenance

After a cleaning cycle, wipe up the ash residue left by the pyrolytic cleaning process. Do not hesitate to run a cleaning cycle as often as necessary. We recommend you to run a pyrolytic cycle once per month. This is just an indication : the frequency depends on the level of soiling.

Run the cleaning cycle immediately after cooking to take advantage of the residual heat in the oven. The cleaning process will mean the oven is unavailable for use for approximately 2 hours 30 minutes.

How to proceed ?

1. Empty the oven of all accessories (oven shelves, grill pan). The high temperature during the pyrolytic cycle could damage them as well as the cavity.
2. If necessary, remove all excess soilage which could cause too much smoke to be absorbed by the catalyser.
3. Close the oven door.
4. Set the function selector and temperature controls on the pyrolytic  position .
5. Programme the pyrolytic cleaning in semi-automatic or fully automatic operation (see following page).
6. Once the pyrolytic cycle time is over :

Return the control knobs to their OFF positions (temperature control on ● and then function selector on 0).



The “oven on” neon indicator switches off and the door unlocks when the temperature inside the oven is cool enough.

Cleaning the accessories

Clean them with a warm washing up liquid solution. Rinse and dry carefully.

Programming semi-automatic cleaning

Immediate start - Automatic stop

1. Set the function selector and thermostat controls on the pyrolytic  positions : **P1.30**,  and **AUTO** are displayed (pyrolysis lasting : 1 hour 30 minutes).

If your oven is badly soiled, you may increase the time :

2. Press button "**COOK TIME**" and, at the same time, turn the time setting knob to increase the duration time of the pyrolytic cleaning (maximum time is three hours).

Once the pyrolytic cycle time is over : **P0.00** and **AUTO** flash, pilot light  disappears.

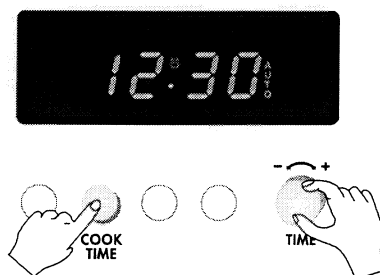

3. Turn the function and temperature knobs to the Off position (temperature control on  and function selector on **0**) : **AUTO** disappears. The current time of the day reappears.

It is perfectly normal for the oven door to remain locked after the end of the cleaning process, until the oven has cooled down sufficiently.





Programming fully automatic cleaning

Deferred start - Automatic stop

1. Set function selector and thermostat controls on the pyrolytic  positions : **P1.30**,  and **AUTO** are displayed (pyrolysis lasting : 1 hour 30 minutes).

If your oven is badly soiled, you may increase this time :

2. Press button "**COOK TIME**" and, at the same time, turn the time setting knob to increase the duration time of the pyrolytic cleaning (maximum time is three hours).
3. Press button "**END TIME**" and at the same time turn the time setting knob until the end pyrolytic cleaning time is displayed.  disappears.

Pilot light  will be displayed when it is time to start the pyrolytic cleaning cycle.

4. Turn the function and temperature knobs on the Stop position (temperature control on  and function selector on **0**) : **AUTO** disappears. The current time of the day reappears.

It is perfectly normal for the oven door to remain locked after the end of the cleaning cycle, until the oven has cooled down sufficiently.

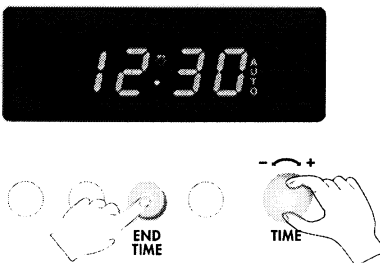
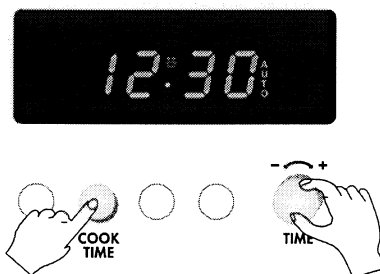

SOMETHING NOT WORKING

Please carry out the following checks on your appliance before calling a service Engineer. It may be that the problem is a simple one, which you can solve yourself without the expense of a service call.



If the cooker shows any sign of a fault, we recommend you do not use it. Disconnect the cooker from the mains or remove the fuse on the appropriate circuit.

Symptom	Solutions
Neither the ceramic hotplate or the oven work The cooker does not operate	<ul style="list-style-type: none"> • Check that the unit is connected to the electrical supply. • Check that the RCCB has not tripped (if fitted). • Check that the mains fuse has not blown. • Check that the correct control knob has been turned.
The oven does not heat (the time on the electronic programmer is correctly set)	<ul style="list-style-type: none"> • Check that the child safety has not been set.
Cooking results are not satisfactory	<ul style="list-style-type: none"> • Check that the cooking pan is the correct size for the cooking zone. • Check that the cooking pan has a flat base. • Check that the setting is correct for the type of cooking. • The temperature may need adjusting. • Refer to the contents of this booklet, especially to the chapter "Cooking functions". • Leave dishes inside the oven no longer than 15-20 minutes after the cooking is completed.
The oven produces smoke	<p>Check to see if:</p> <ul style="list-style-type: none"> • the oven needs cleaning. • the dish being cooked has spilled. • there have been any excessive splashes of grease/juice on the oven walls. • the selected temperature and cooking position are correct, particularly for cooking meats.
The timer keeps flashing 0.00.	<p>Check that:</p> <ul style="list-style-type: none"> • there has not been a power failure.

If the problem still persists after these checks, contact the Service Force Centre.

In-guarantee customers should ensure that the above checks have been made as the engineer will make a charge if the fault is not a mechanical or electrical breakdown.

Please note that it will be necessary to provide proof of purchase for any in-guarantee service calls.

SERVICE AND SPARE PARTS

In the event of your appliance requiring service, or if you wish to purchase spare parts, please contact your local Service Force Centre by telephoning :

08705 929929

Your telephone call will be automatically routed to the Service Force Centre covering your post code area.

For the address of your local Service Force Centre and further information about Service Force, please visit the website at www.serviceforce.co.uk

Before calling out an engineer, please ensure you have read the details under the heading "SOMETHING NOT WORKING"

For Customer Service in Ireland please contact us at the address below :

Tricity Bendix
Electrolux Group (Irl) Ltd
Long Mile Road
Dublin 12
Republic of Ireland

Tel : +353 (0)1 4090752

Email: service.eid@electrolux.ie

When you contact the Service Force Centre you will need to give the following details :

1. Your name, address and post code
2. Your telephone number
3. Clear and concise details of the fault
4. The model and serial number of the appliance (found on the rating plate)
5. The purchase date

Please note that a valid purchase receipt or guarantee documentation is required for in-guarantee service calls.

Customer Care Department

For general enquiries concerning your TRICITY BENDIX appliance or for further information on TRICITY BENDIX products, please contact our Customer Care Department by letter or telephone at the address below or visit our website at www.tricity-bendix.co.uk

Customer Care Department

Tricity Bendix
55-77 High Street
Slough
Berkshire
SL1 1DZ

Tel : 08705 950 950 *

* calls to this number may be recorded for training purposes.

GUARANTEE CONDITIONS

STANDARD GUARANTEE CONDITIONS

We, TRICITY BENDIX, undertake that if, within 12 months of the date of purchase, this TRICITY BENDIX appliance or any part thereof is proved to be defective by any reason only of faulty workmanship or materials, we will, at our option, repair or replace the same FREE OF CHARGE for labour, materials or carriage on condition that :

- The appliance has been correctly installed and used only on the electricity supply stated on the rating plate.
- The appliance has been used for normal domestic purposes only, and in accordance with the manufacturer's instructions.
- The appliance has not been serviced, maintained, repaired, taken apart or tampered with by any person not authorised by us.
- All service work under this guarantee must be undertaken by a TRICITY BENDIX Service Force Centre.
- Any appliance or defective part replaced shall become the Company's property.
- This guarantee is in addition to your statutory and other legal rights.

Home visits are made between **8.30am** and **5.30pm** Monday to Friday. Visits may be available outside these hours, in which case a **premium** will be charged.

Exclusions

This guarantee does not cover :

- Damage or calls resulting from transportation, improper use or neglect, the replacement of any light bulb or removable parts of glass or plastic.
- Costs incurred for calls to put right an appliance which is improperly installed or calls to appliances outside the European Community (EC) or European Free Trade Area.
- Appliances found to be in use within a commercial environment, plus those which are subject to rental agreements.
- Products of TRICITY BENDIX manufacture which are not marketed by TRICITY BENDIX.

European Guarantee

If you should move to another country within EUROPE then your guarantee moves with you to your new home subject to the following qualifications :

- The guarantee starts from the date you first purchased your product.
- The guarantee is for the same period and to the same extent for labour and parts as exists in the new country of use for this brand or range of products.
- This guarantee relates to you and cannot be transferred to another user.
- Your new home is within the European Community (EC) or European Free Trade Area.
- The product is installed and used in accordance with our instructions and is only used domestically, i.e. a normal household.
- The electricity supply complies with the specifications given on the rating plate.
- The product is installed taking into account regulations in your new country.

Before you move, please contact your nearest Customer Care Centre, listed below, to give them details of your new home. They will then ensure that the Local Service Organisation is aware of your move and able to look after you and your appliances.

France	Senlis	+33 (0)3 44 62 20 13
Germany	Nürnberg	+49 (0)800 234 7378
Italy	Pordenone	+39 (0)800117511
Sweden	Stockholm	+46 (0)20 78 77 50
UK	Slough	+44 (0)1753 219898
Ireland	Dublin	+353 (0)1 4090752



The rating plate

It is advisable to make a note of some details below and keep for reference **BEFORE THE APPLIANCE IS INSTALLED**.

The rating plate is located on the left hand side under the front edge of the control panel.

This information (model, product number, serial number) should be quoted in any correspondence or if Service Force is contacted).

	BRAND	Model	
		Product nb	
		Serial nb	
	60 Senlis Const. N110	Made in E.U	

FOR THE INSTALLER

Safety instructions

- The adjacent kitchen furniture must not be higher than the cooker.
- Walls adjacent to the cooker must be made of a heat resistant material, or be coated with a heat resistant material.

Positioning the cooker

Your cooker is provided with 4 height adjustable feet to achieve a perfect stability.

Fitting the stability bracket

(not supplied)

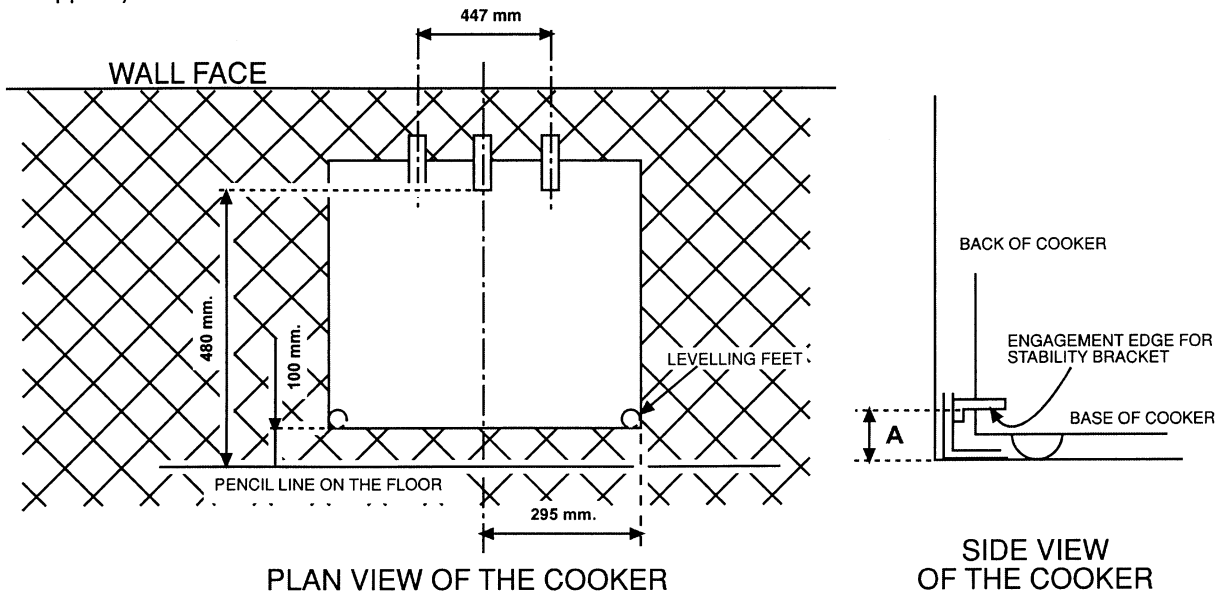

If a stability bracket should be fitted by the installer, these instructions should be read in conjunction with the leaflet packed with the stability bracket.

Place the cooker in its intended position and level cooker.

Mark off 295 mm (11 1/2") from the right hand side of the cooker as shown, this is the centre line of the bracket fixing.

Draw a line 100 mm (4") from the front edge of the levelling feet (see the drawing) and remove the cooker from its position.

Mark off 480mm (19") back from this line on the centre line of the bracket to locate the front edge of the lower bracket.

Fix lower bracket (with two fixing holes) to the floor, then measure height from floor level to engagement edge on back of the cooker, dimension 'A' on the drawing.

Assemble upper bracket to lower bracket so that underside of bracket is dimension 'A'+3 mm (1/8") above floor level. Re-position cooker and check that top bracket engages into the cooker back to a depth of 75 mm (3"), as shown on the drawing.

Electrical connection

Cookers are designed to operate exclusively on 50 Hz AC power - (refer to the label stuck on the cord).

Check that:

- the mains supply is correct,
- the mains cable is not damaged,
- the mains cable is the correct specification,
- the mains supply is provided with a means of isolation comprising of a double pole switch with a minimum contact opening distance of 3 mm, and ensuring that the earth connection is not broken.

Installation and maintenance must be done by a qualified professional in accordance with the regulatory texts and current IEE regulations.

We cannot be held responsible for accidents or incidents caused by incorrect or defective earthing.

Mains cable

This cooker is supplied with a special heat resistant mains cable (type H07 RN-F / 2,00 m), which **MUST NOT** be removed. If this cable becomes damaged, or needs to be replaced for any reason, then only the cable with **Part Number 337225201/9** must be used, which can be obtained from your local Service Force Centre.

The manufacturer will not be responsible for any damage or injury if this warning is ignored.

Fuse rating

30 Amps

TECHNICAL INFORMATION

Commercial reference

Electrical connection

SE545P

230 V 50 Hz

Cooking hob	Front right element	Hilight element (radiant)	1,20 kW Ø 145 mm
	Rear right element	Hilight element (radiant)	2,30 kW Ø 210 mm
	Front left element	Hilight element (radiant)	1,80 kW Ø180 mm
	Rear left element	Hilight element (radiant)	1,20 kW Ø 145 mm
Oven	Oven	electric	
	Oven power	2,40 kW	
	Grilling	electric	
	Grilling power	2,90 kW	
	Oven lighting	bulb 25 W type E14	
	Type of cleaning	pyrolytic	
Minute minder, time setting & cleaning programming	Electronic programmer		
Accessories	2 wire shelves		
	1 grill pan		
	Drawer to tidy the accessories		
	Mains cable	2,00 m	
Dimensions	Height to the cooking hob	90 cm	
	Width	59,5 cm	
	Depth	61,8 cm	
	Weight	61,5 kg	

The **CE** mark meets the requirements laid down in directives : electromagnetic compatibility 89/336,

CE mark 93/68 and low voltage 73/23.

3372489-01

TRICITY BENDIX

Tricity Bendix, 55-77High Street, Slough, Berkshire SL1 1DZ

Consumer care telephone number 08705 950950