

# OWNER'S MANUAL

**PrecisionPower™**  
*Absolutely State of the Art Mobile Audio™*

**DCX-730**

**6 Channel Digital Signal Processor (DSP)**



## INTRODUCTION

---

Thank you for choosing *PrecisionPower™* audio equipment. At *PrecisionPower™* we proudly design and engineer the world's finest audio products. Our award winning products utilize innovative design and technology to consistently deliver ***Absolutely State of the Art™*** performance, sound quality, reliability, and value. This *PrecisionPower™* product reflects our commitment to offer you unparalleled versatility and quality for years of dependable service and listening enjoyment.

## SERVICE

---

Do not attempt to service *PrecisionPower™* products yourself. Performing exploratory surgery on your audio equipment yourself will void the warranty. Many parts of your *PrecisionPower™* gear are custom built to our specifications. Our factory parts are not made available to anyone else nor are they for sale. Our goal is to make sure that your *PrecisionPower™* product will always sound as good as the day it was purchased. Contact your authorized *PrecisionPower™* dealer about obtaining any warranty service. (See Warranty inside back cover.)

Model: DCX-730

Serial Number: \_\_\_\_\_

Date of Purchase: \_\_\_\_\_

## CAUTION

---

High-powered car audio systems may produce sound pressure levels that exceed the threshold at which hearing loss may result. They may also impair a driver's ability to hear traffic sounds or emergency vehicles. Use common sense and practice safe listening habits when listening to or adjusting your audio system.

## FEATURES/SPECIFICATIONS

---

- 24-bit DSP
- Adjustable DSP crossover
- 5 presets
- Mini USB port for control of functions via pc
- QBASS filter for programmable low frequency boost
- Built-in remote output with turn-on delay for switching on amps
- Controller features half-din chassis for ease of installation

## INSTALLATION

---

1. Read this manual carefully and in its entirety before installing the DCX-730.
2. Always disconnect the battery or remove the fuses for circuits you will be working on.
3. Check for clearance of any hazards such as wiring harnesses or heater core before mounting the equalizer to any panels in the vehicle.
4. Mount the DCX-730 controller and processing module in a location that is easy to access. The processing module should be mounted within the passenger or trunk compartments. Do **NOT** mount the processing module in the engine compartment.
5. Route all power wires and audio cables away from sharp metal edges that can cause shorts to ground and any moving parts that can tangle the wires such as heater controls or wiper motors.
6. Route all power and signal cables as far as possible from other vehicle wiring harnesses. Loom when appropriate.
7. It is recommended that the DCX-730 processor be grounded at a chassis point (preferably bare or scraped sheet metal) near to where the processor is mounted. The DCX-730 controller should be grounded at a chassis point (preferably bare or scraped sheet metal) other than the factory head unit ground wire or under dash brackets.
8. Use only the supplied machine screws to mount the DCX-730 or damage to the circuitry could occur.

## CONTROLLER FEATURES

---

### Controls and Display

The DCX-730 has the following features.

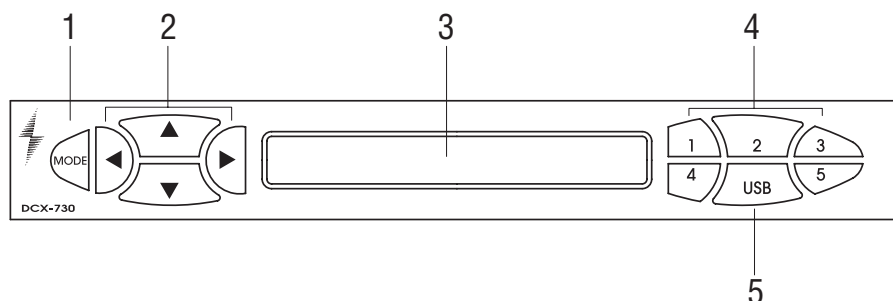

1. Mode. Press this button to return to the Home menu.

2. Arrows. Use the arrow buttons to navigate through the menus and to adjust a menu setting.
3. LCD Display. Backlit display, soft-blue background for easy viewing at night.
4. Presets. Five preset buttons to allow you to select from 5 settings that you have entered. Examples of these presets would be for the type of music, different volume settings, different audio sources.
5. USB. Open this cover to plug in a mini-USB connector. This port is used to upgrade the software in the controller and to allow the installer to load in parameters for known vehicle acoustical environments using a pc.

The controller connects to the processing module (shown below) by means of a long cable at the back of the controller. This cable powers the controller from the processing module and gives the audio settings to the processing module.

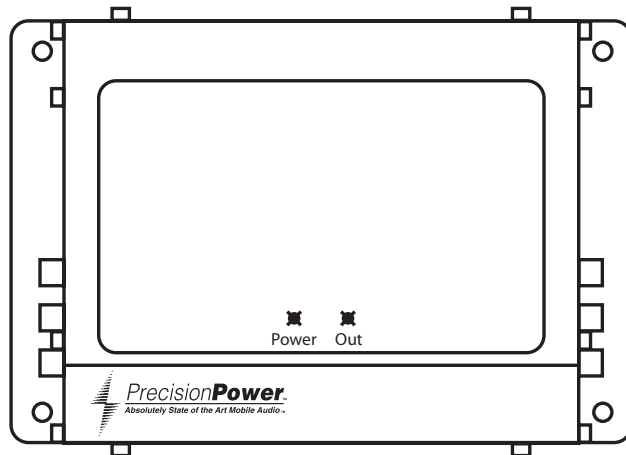

The top panel has a green power on indicator LED and a red clipping (out) indicator LED. If the clipping LED indicator is illuminating, the DCX-730 requires adjustment. Damage to your speakers could result from the DCX-730 being improperly adjusted.

## **PROCESSING MODULE**

The processing module is designed so that it can be integrated into almost any installation. All of the audio flows through the processing module prior to going to the amplifier. This allows the processing module to be mounted in a remote location where the audio signal path length can be kept to a minimum. The unit must be mounted in a location where it will not be subject to excessive temperature or vibration. The processing module should be installed in the passenger compartment or the trunk of the vehicle. Do **NOT** install this unit in the engine compartment, as the unit will be exposed to extreme temperatures and weather.

## Input Connections

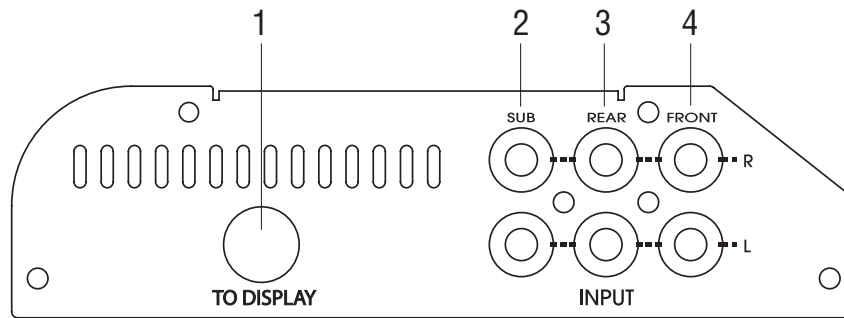

1. Connects to the display controller cable. This cable supplies power to the controller module and transmits control and display signals between the display and processor module.
2. SUB right and left input, RCA phono connections.
3. REAR right and left input, RCA phono connections.
4. FRONT right and left input, RCA phono connections.

## Output and Power Connections

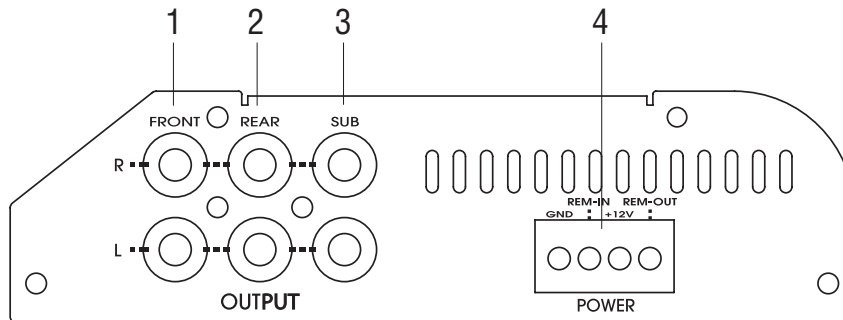

1. FRONT right and left output, RCA phono connections to amplifier.
2. REAR right and left output, RCA phono connections to amplifier.
3. SUB right and left output, RCA phono connections to amplifier.
4. Power connections for Ground, Remote In, +12V, and Remote Out.

## OPERATION

When the unit is first powered up, the home menu will show on the LCD display. The Home icon in the upper left corner of the LCD screen will be highlighted and the Precision Power DCX-730 message appears.

**NOTE:** Pressing the Mode button at any time will return you to the Home menu. Also, if the unit is in one of the other menus and is

*left unattended for over a minute, the unit will return to the Home menu. If any of the settings are changed pressing the Mode button or after one minute elapses, the setting(s) will be saved to preset 6. Preset 6 is a scratchpad where settings are saved temporarily so that the setting(s) can be tried before saving to one of the 5 presets.*

The DCX-730 controller contains the control and provides the menu driven displays to adjust the digital processing power available within the unit. The user interface consists of a series of menus shown on the display and arrow buttons to navigate through the menus and to also set the individual available settings. These settings can then be saved to individual presets (maximum of 5) by using the number keys on the right hand side of the controller.

### Arrow Buttons

Use the arrow buttons to navigate through the available menus and to adjust parameters. At the top level the ► arrow button will advance you to the next menu level. Once the desired parameter is selected, use the ◀/▶ buttons to move the cursor over to the parameter. You can then adjust the value of that parameter with the ▲/▼ arrow buttons.

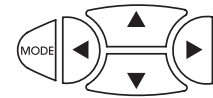

### Recalling Presets

While in the Home menu, if you press any of the numbered buttons on the right side of the controller the presets stored for that corresponding number will be loaded. The active preset presently used is displayed by the number in the square below the Home icon on the LCD panel. If a 6 is displayed there is no active preset loaded.

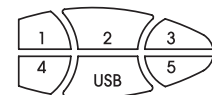

Home Menu Display

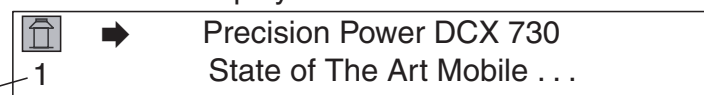

Indicates the preset memory location currently used. Use the number keys on the right side of the DCX-730 to select a Preset memory to be loaded. To store current parameters to a preset, push the preset button while in any menu other than home.

When a preset is being loaded the following screen displays.

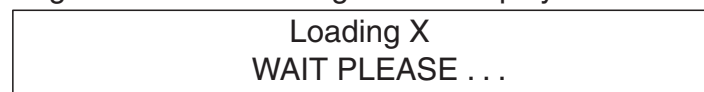

## Storing Presets

While in any of the parameter menus, you can save any changes to settings by pressing the desired number button that you wish these settings to be saved to. The parameters which have changed will replace the default parameters in the preset.

When a preset is being saved the following screen displays.

Saving X  
WAIT PLEASE . . .

## MENUS

---

### Sensitivity

The sensitivity parameter adjusts the unit's gain (input attenuation) to match the corresponding head unit. This allows you to run the head unit, DCX-730, and amplifiers at their optimum gain settings for minimum noise. The attenuation setting allows further reduction of the input level to allow inputs up to 12 volts to be accommodated.

Input Level:	0 to 2.9V
Attenuation:	0db to -12db (when adjusted to -12db the input level is now 0 to 12 v.

When adjusting the system you should avoid running the DCX-730 into clipping. Use the built-in clip indicator for reference. Clipping in the digital domain can be much harsher.

***NOTE:*** *Because of the nature of the analog/digital audio conversion process, the sensitivity setting allows for 6dB of headroom (that is, an input level of 1 V rms drives the sensitivity setting of 0.5V rms to near clipping) prior to digital clipping.*

### Volume

The volume parameter adjusts the output level of the DCX-730. For normal use this would be set to approximately -10 to -15dB. Then adjust the sensitivity of the amplifier following normal gain adjustment guidelines provided with the amplifier.

## Delay

The delay parameter allows you to adjust the delay of individual channels by up to 70 msec. For example, this allows adjusting the driver's side speakers audio to coincide with the arrival of the passenger side speaker at a listening point in the vehicle. Similarly, the audio arrival from the front and rear speakers can be adjusted. Using biamped connections and delay adjustment, this can help compensate for installations where the optimum tweeter mounting location will not accommodate woofer mounting and the effect of signal arrival differences can be minimized.

Use the following instructions to set the delay parameter for each speaker. The table printed below is provided for your use in facilitating the delay setup.

1. Set the delay of the farthest speaker from the desired listening position to zero.
2. Measure, in inches, and record the distance from the desired listening position to the farthest speaker. This is your baseline measurement.
3. Measure, in inches, and record the distance from the listening position to each of the remaining speakers. Each speaker should correspond to a channel of the output from the DCX-730.
4. Subtract the distance of the baseline speaker from each of the other speakers (for a given channel of the DCX-730) and record that value (these will all be negative values).
5. Divide each of these differences by 13.52 (value at 68°F) to set the required delay settings in msec for each of the remaining speakers. The exact speaker path length differences will appear for each channel as you enter the msec delay value.

**NOTE:** The value of 13.52 varies with temperature, a chart is given at the end of this discussion listing values to be used with different temperatures. The error in this value is at the most 5% between temperatures of 50°F to 100°F.

For example: The baseline speaker (farthest away) measures 60 inches. The LT (left tweeter) measures 20 inches. The difference is  $20-60=-40$  inches. The delay time correction is  $-40/13.52$  which equals a delay setting of -2.96 mS (a setting of 2.96 will be entered into the DCX-730 channel for the LT speaker).



Speaker Element	Distance	Difference	Time Correction mS
LT (left tweeter)			
LM (left mid)			
LW (left woofer)			
RT (right tweeter)			
RM (right mid)			
RW (right woofer)			

Temperature	Correction Factor
50°F	13.29
60°F	13.42
70°F	13.55
80°F	13.67
90°F	13.80
100°F	13.92
110°F	14.05

## **EQ (Equalization)**

Frequency: 20 Hz to 20 kHz  
Q: 0.1 TO 9.00  
Level: ±18dB

The equalization adjustment allows up to 7 bands per channel of parametric equalization. These allow you to equalize problem areas in the response by matching the equalization filter shape to the response. Also the option of using high or low shelving filters allows the creation of boosts and cuts at each end of the spectrum, similar to existing analog tone controls.

## **Xover**

High  
Low  
Bandpass  
1st, 2nd, 3rd, 4th order (6/12/18/24dB/oct slopes)

The crossover section features up to 4th order filters that are high/low, and bandpass. This allows the creation of a stereo 3-way crossover. The filter shape can be either traditional Butterworth, or Linkwitz-Riley filters that are more suitable for systems with drivers that are not concentrically mounted.

## **QBASS**

Freq: 20 Hz to 150 Hz  
Steps: 1dB  
Q: 0.1 to >9.00  
Level: +0dB to >+18dB

The QBASS filter allows boosting the lower frequencies (20Hz-150Hz) to make up for deficiencies, as well as increasing the perception of bass. Unlike the EQ filters, this feature is a boost-only filter system.

**NOTE:** Because QBASS is a boost only EQ system, it is easy to either clip the amplifier, or overdrive a speaker past its excursion limits. To make up for frequency response that is 10dB down (say at 45 Hz), 10X the amplifier power is required. This may tax both driver and amplifier. It may also exhaust the headroom in the DSP controller. This issue is especially problematic in vented (ported) speaker enclosures, where the cone excursion increases considerably below the port tuning frequency. If you hear any sign of bottoming, or other speaker or amplifier misbehavior, try reducing the amount of bass boost. This is also possible with any EQ band set to excessive boost.

## TYPICAL SYSTEM DIAGRAM

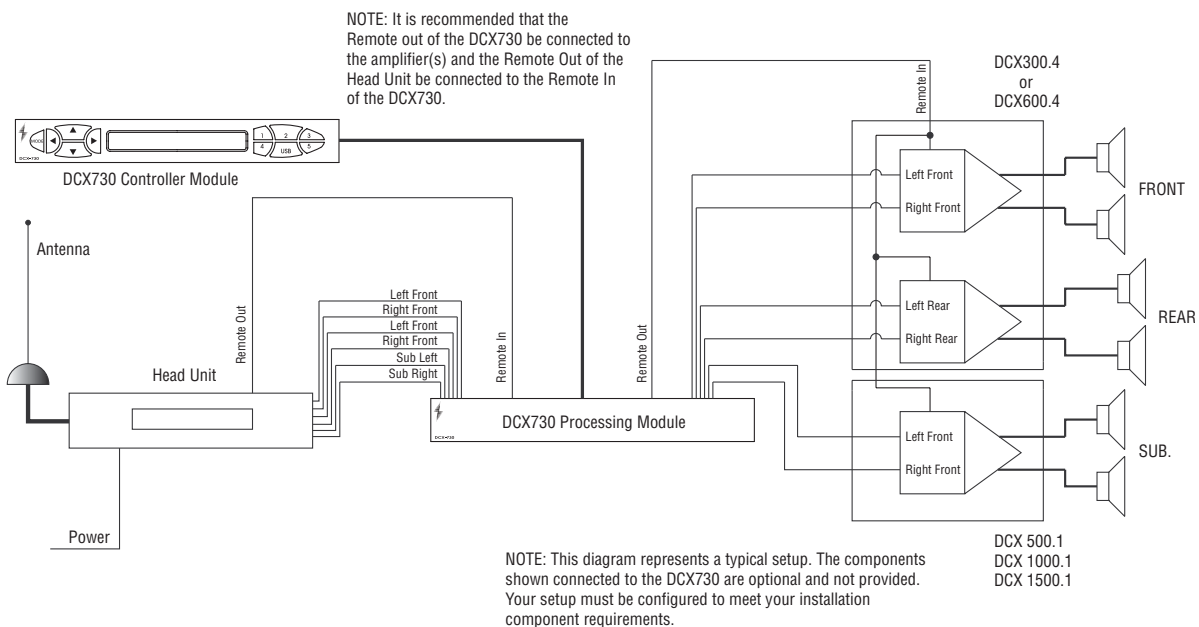

**NOTE:** Although the input and output connections are labeled with typical application, any input can be routed to any output. The caveat here is to make sure that all of the presets that you plan to use contain the same routing. This can be easily accomplished by storing the preset to preset #1, recalling preset #1 (press the mode button, then the 1 button), then the left arrow, (to bring up the sensitivity menu) then pressing 2. Repeat this procedure for 3, 4, and 5. This only needs to be done at the initial installation.

The Remote Out contains a 2-sec delayed turn-on signal that can be used to extend the turn-on time of downstream devices (amplifiers).

## SPECIFICATIONS

---

### Analog

RCA Outputs	6 paired RCA jacks
RCA Inputs	6 paired RCA jacks
Output Level	7.5V rms, maximum
Output THD+N	<0.05%, 30kHz BW
Input Topology	Precision Power Balanced Differential
Signal-to-Noise Ratio	>85dBA @ max output
Frequency Response	20-20,000 Hz $\pm$ 0.25 dB
Input Impedance	>10k ohms
Input Sensitivity	250mV to 12V rms, (12V rms with -12dB attenuation)

### Digital Signal Processing (DSP)

Crossover type/range	DSP crossover incorporating 6dB/12dB/18dB/24dB per octave slopes Butterworth/Linkwitz-Riley filters Low Pass—20Hz to 20kHz High Pass—20Hz to 20kHz Band Pass—20Hz to 20kHz
Crossover Slope	6dB/12dB/18dB/24dB per octave
Q-BASS	Variable 0 to +18dB boost @20Hz-150Hz Variable Q 0.1-9.0
Delay	Variable 0-70 msec each channel
EQ	7 band parametric EQ/LO/HIGH shelving, each channel $\pm$ 18dB, Q variable 0.1-9.0
Presets	5 user presets
Sample Rate	48kHz
Bit Depth	24 bit effective resolution
Input/Output Delay	<3msec with all filters flat

### Control Interface

Built-in Display	2 line x 16 character LCD display with blue backlight
Keyboard	10 front panel buttons
USB Port	Future use

### Power

Supply voltage	9 to 16 VDC
Remote power output	2-second delay - max current 100 mA
Fuse	2.5 amps (5mm x 20mm)

## LIMITED TWO YEAR CONSUMER WARRANTY:

Directed Electronics, Inc. promises to the original purchaser, to replace this product should it prove to be defective in workmanship or material under normal use, for a period of two years from the date of purchase by the dealer as indicated by the date code marking of the product PROVIDED the product was installed by an authorized Directed dealer. During this two-year period, there will be no charge for this replacement PROVIDED the unit is returned to Directed, shipping pre-paid. If the unit is installed by anyone other than an authorized Directed dealer, the warranty period will be 1 year from the date of purchase by the dealer as indicated by the date code marking of the product. During this 1-year period there will be no charge for this replacement PROVIDED the unit is returned to Directed, shipping pre-paid. This warranty is non-transferable and does not apply to any unit that has been modified or used in a manner contrary to its intended purpose, and does not cover damage to the unit caused by installation or removal of the unit. This warranty is void if the product has been damaged by accident or unreasonable use, neglect, improper service or other causes not arising out of defects in materials or construction. ALL WARRANTIES INCLUDING BUT NOT LIMITED TO EXPRESS WARRANTY, IMPLIED WARRANTY, WARRANTY OF MERCHANTABILITY, FITNESS FOR PARTICULAR PURPOSE, AND WARRANTY OF NON-INFRINGEMENT OF INTELLECTUAL PROPERTY ARE EXPRESSLY EXCLUDED TO THE MAXIMUM EXTENT ALLOWED BY LAW, AND DIRECTED NEITHER ASSUMES NOR AUTHORIZES ANY PERSON TO ASSUME FOR IT ANY LIABILITY IN CONNECTION WITH THE SALE OF THE PRODUCT. DIRECTED HAS ABSOLUTELY NO LIABILITY FOR ANY AND ALL ACTS OF THIRD PARTIES INCLUDING ITS AUTHORIZED DEALERS OR INSTALLERS. Unit must be returned to Directed, postage pre-paid, with: consumer's name, telephone number, and address, authorized dealer's name and address, and product description. IN ORDER FOR THIS WARRANTY TO BE VALID, YOUR UNIT MUST BE SHIPPED WITH PROOF OF INSTALLATION BY AN AUTHORIZED DIRECTED DEALER. ALL UNITS RECEIVED BY DIRECTED FOR WARRANTY REPAIR WITHOUT PROOF OF DIRECTED DEALER INSTALLATION WILL BE COVERED BY THE LIMITED 1-YEAR PARTS AND LABOR WARRANTY. Note: This warranty does not cover labor costs for the removal and reinstallation of the unit. BY PURCHASING THIS PRODUCT, THE CONSUMER AGREES AND CONSENTS THAT ALL DISPUTES BETWEEN THE CONSUMER AND Directed SHALL BE RESOLVED IN ACCORDANCE WITH CALIFORNIA LAWS IN SAN DIEGO COUNTY, CALIFORNIA.

