

Panasonic®

Operating Instructions High Definition Plasma Display

Model No. **TH-103PF12U**



The illustration shown is an image.

HDMI™
HIGH-DEFINITION MULTIMEDIA INTERFACE

Before connecting, operating or adjusting this product, please read these instructions completely.
Please keep this manual for future reference.

English

TQBC2518

| | | |
|--|---|---|
|  | CAUTION RISK OF ELECTRIC SHOCK DO NOT OPEN |  |
| WARNING: To reduce the risk of electric shock, do not remove cover or back. No user-serviceable parts inside. Refer servicing to qualified service personnel. | | |



The lightning flash with arrow-head within a triangle is intended to tell the user that parts inside the product are a risk of electric shock to persons.



The exclamation point within a triangle is intended to tell the user that important operating and servicing instructions are in the papers with the appliance.

WARNING : To prevent damage which may result in fire or shock hazard, do not expose this apparatus to rain or moisture.
Do not place containers with water (flower vase, cups, cosmetics, etc.) above the set.
(including on shelves above, etc.)

WARNING : 1) To prevent electric shock, do not remove cover. No user serviceable parts inside. Refer servicing to qualified service personnel.
2) Do not remove the grounding pin on the power plug. This apparatus is equipped with a three pin grounding-type power plug. This plug will only fit a grounding-type power outlet. This is a safety feature. If you are unable to insert the plug into the outlet, contact an electrician.
Do not defeat the purpose of the grounding plug.

Important Safety Instructions

- 1) Read these instructions.
- 2) Keep these instructions.
- 3) Heed all warnings.
- 4) Follow all instructions.
- 5) Do not use this apparatus near water.
- 6) Clean only with dry cloth.
- 7) Do not block any ventilation openings. Install in accordance with the manufacturer's instructions.
- 8) Do not install near any heat sources such as radiators, heat registers, stoves, or other apparatus (including amplifiers) that produce heat.
- 9) Do not defeat the safety purpose of the polarized or grounding-type plug. A polarized plug has two blades with one wider than the other. A grounding type plug has two blades and a third grounding prong. The wide blade or the third prong are provided for your safety. If the provided plug does not fit into your outlet, consult an electrician for replacement of the obsolete outlet.
- 10) Protect the power cord from being walked on or pinched particularly at plugs, convenience receptacles, and the point where they exit from the apparatus.
- 11) Only use attachments / accessories specified by the manufacturer.
- 12) Use only with the cart, stand, tripod, bracket, or table specified by the manufacturer, or sold with the apparatus. When a cart is used, use caution when moving the cart / apparatus combination to avoid injury from tip-over.
- 13) Unplug this apparatus during lightning storms or when unused for long periods of time.
- 14) Refer all servicing to qualified service personnel. Servicing is required when the apparatus has been damaged in any way, such as power-supply cord or plug is damaged, liquid has been spilled or objects have fallen into the apparatus, the apparatus has been exposed to rain or moisture, does not operate normally, or has been dropped.
- 15) To prevent electric shock, ensure the grounding pin on the AC cord power plug is securely connected.



Dear Panasonic Customer

Welcome to the Panasonic family of customers. We hope that you will have many years of enjoyment from your new Plasma Display.

To obtain maximum benefit from your set, please read these Instructions before making any adjustments, and retain them for future reference.

Retain your purchase receipt as well, and record the model number and serial number of your set in the space provided on the rear cover of these instructions.

Visit our Panasonic Web Site <http://panasonic.net>

Table of Contents

| | | | |
|--|----|--|----|
| Important Safety Instructions | 3 | Reduces power consumption | 42 |
| FCC STATEMENT | 5 | Customizing the Input labels | 43 |
| Safety Precautions | 6 | Selecting the On-Screen Menu Language | 43 |
| Maintenance | 7 | DISPLAY ORIENTATION | 44 |
| Accessories | 8 | SET UP for MULTI DISPLAY | 45 |
| Accessories Supplied..... | 8 | How to setup MULTI DISPLAY | 45 |
| Remote Control Batteries | 8 | ID Remote Control Function..... | 46 |
| Connections | 9 | MULTI PIP SETUP | 47 |
| AUDIO OUT Terminals connection..... | 9 | SET UP for PORTRAIT | 48 |
| PC Input Terminals connection..... | 10 | How to setup PORTRAIT | 48 |
| SERIAL Terminals connection | 11 | SET UP for Input Signals | 50 |
| HDMI connection..... | 12 | COMPONENT / RGB IN SELECT..... | 50 |
| COMPONENT / RGB connection | 12 | YUV / RGB IN SELECT..... | 50 |
| Power ON / OFF | 13 | SIGNAL menu | 51 |
| Selecting the input signal | 15 | 3D Y/C FILTER..... | 51 |
| Basic Controls | 16 | COLOR SYSTEM / Panasonic AUTO | 52 |
| ASPECT Controls | 18 | 3:2 PULLDOWN | 52 |
| MULTI PIP | 19 | XGA MODE | 52 |
| Digital Zoom | 22 | REFRESH RATE | 53 |
| On-Screen Menu Displays | 23 | NOISE REDUCTION | 53 |
| Adjusting POS. /SIZE | 25 | SYNC | 54 |
| PICTURE Adjustments | 28 | SDI THROUGH | 54 |
| ADVANCED SETTINGS..... | 29 | Input signal display..... | 54 |
| Picture Profiles | 30 | Options Adjustments | 55 |
| Saving profiles..... | 31 | Weekly Command Timer | 58 |
| Loading profiles | 32 | Shipping condition | 59 |
| Editing profiles..... | 32 | Troubleshooting | 60 |
| Locking profiles | 33 | List of Aspect Modes | 61 |
| SOUND Adjustment | 35 | Applicable input signals | 62 |
| SDI SOUND OUTPUT..... | 35 | Command list of Weekly Command Timer | 64 |
| PRESENT TIME SETUP / SET UP TIMER | 36 | Specifications | 65 |
| PRESENT TIME SETUP | 36 | Panasonic Professional Flat Panel Display | |
| SET UP TIMER | 36 | Limited Warranty | 66 |
| SCREENSAVER (For preventing image retention) .. | 37 | LIMITED WARRANTY STATEMENT | 67 |
| Setup of SCREENSAVER Time | 38 | Customer Service | 68 |
| Reduces screen image retention | 39 | | |
| EXTENDED LIFE SETTINGS | 39 | | |

FCC STATEMENT

This equipment has been tested and found to comply with the limits for a Class B digital device, pursuant to Part 15 of the FCC Rules. These limits are designed to provide reasonable protection against harmful interference in a residential installation. This equipment generates, uses and can radiate radio frequency energy and, if not installed and used in accordance with the instructions, may cause harmful interference to radio communications. However, there is no guarantee that interference will not occur in a particular installation. If this equipment does cause harmful interference to radio or television reception, which can be determined by turning the equipment off and on, the user is encouraged to try to correct the interference by one or more of the following measures:

- Reorient or relocate the receiving antenna.
- Increase the separation between the equipment and receiver.
- Connect the equipment into an outlet on a circuit different from that to which the receiver is connected.
- Consult the dealer or an experienced technician for help.

This device complies with Part 15 of the FCC Rules. Operation is subject to the following two conditions: (1) This device may not cause harmful interference, and (2) this device must accept any interference received, including interference that may cause undesired operation.

FCC CAUTION:

To assure continued compliance, follow the attached installation instructions and use only shielded interface cables when connecting to computer or peripheral devices. Any changes or modifications not expressly approved by Panasonic Corp. of North America could void the user's authority to operate this device.

FCC Declaration of Conformity

Model No. TH-103PF12U

Responsible Party: Panasonic Corporation of North America
One Panasonic Way 1F-10, Secaucus, NJ 07094
Contact Source: Panasonic Professional Display Company
Panasonic Plasma Concierge 1-800-973-4390

CANADIAN NOTICE:

This Class B digital apparatus complies with Canadian ICES-003.

Note:

Do not allow a still picture to be displayed for an extended period, as this can cause a permanent image retention to remain on the Plasma Display.

Examples of still pictures include logos, video games, computer images, teletext and images displayed in 4:3 mode.

Trademark Credits

- VGA is a trademark of International Business Machines Corporation.
- Macintosh is a registered trademark of Apple Inc. USA.
- SVGA, XGA, SXGA and UXGA are registered trademarks of the Video Electronics Standard Association.
Even if no special notation has been made of company or product trademarks, these trademarks have been fully respected.
- HDMI, the HDMI logo and High-Definition Multimedia Interface are trademarks or registered trademarks of HDMI Licensing LLC.

Safety Precautions



CAUTION

This Plasma Display is for use only with the following optional accessories. Use with any other type of optional accessories may cause instability which could result in the possibility of injury.

(All of the following accessories are manufactured by Panasonic Corporation.)

- Pedestal TY-ST103PF9
- Wall-hanging bracket (vertical)..... TY-WK103PV9
- Ceiling-haging bracket TY-CE103PS10
- BNC Component Video Terminal Board..... TY-42TM6A
- BNC Composite Video Terminal Board..... TY-42TM6B
- BNC Dual Video Terminal Board..... TY-FB9BD
- RCA Component Video Terminal Board..... TY-42TM6Z
- RCA Composite Video Terminal Board TY-42TM6V
- RGB Active Through Terminal Board TY-42TM6G
- PC Input Terminal Board TY-42TM6P
- Composite / Component Video Terminal Board..... TY-42TM6Y
- BNC SDI Terminal Board TY-FB7SD
- HD-SDI Terminal Board TY-FB9HD
- HD-SDI Terminal Board with audio TY-FB10HD
- Dual Link HD-SDI Terminal Board..... TY-FB11DHD
- HDMI Terminal Board..... TY-FB8HM
- Dual HDMI Terminal Board TY-FB10HMD
- DVI-D Terminal Board TY-FB11DD
- Ir Through Terminal Board TY-FB9RT
- Wireless Presentation Board TY-FB10WPU
- AV Terminal Box..... TY-TB10AV
- LAN Control Board..... TY-FB12LC

Always be sure to ask a qualified technician to carry out set-up.

Small parts can present choking hazard if accidentally swallowed. Keep small parts away from young children. Discard unneeded small parts and other objects, including packaging materials and plastic bags/sheets to prevent them from being played with by young children, creating the potential risk of suffocation.

■ When using the Plasma Display

Do not bring your hands, face or objects close to the ventilation holes of the Plasma Display.

- Top of the Plasma Display is usually very hot due to the high temperature of exhaust air being released through the ventilation holes. Burns or personal injuries can happen if any body parts are brought too close. Placing any object near the top of the display could also result in heat damages to the object as well as to the Display if its ventilation holes are blocked.

Be sure to disconnect all cables before moving the Plasma Display.

- Moving the Display with its cables attached might damage the cables which, in turn, can cause fire or electric shock.

Disconnect the power plug from the wall outlet as a safety precaution before carrying out any cleaning.

- Electric shocks can result if this is not done.

Clean the power cable regularly to prevent it from becoming dusty.

- Built-up dust on the power cord plug can increase humidity which might damage the insulation and cause fire. Unplug the cord from the wall outlet and clean it with a dry cloth.

This Plasma Display radiates infrared rays, therefore it may affect other infrared communication equipment. Install your infrared sensor in a place away from direct or reflected light from your Plasma Display.

Note:

Do not allow a still picture to be displayed for an extended period, as this can cause a permanent image retention to remain on the Plasma Display.

Examples of still pictures include logos, video games, computer images, teletext and images displayed in 4:3 mode.

WARNING

■ Setup

Do not place the Plasma Display on sloped or unstable surfaces.

- The Plasma Display may fall off or tip over.

Do not place any objects on top of the Plasma Display.

- If water spills onto the Plasma Display or foreign objects get inside it, a short-circuit may occur which could result in fire or electric shock. If any foreign objects get inside the Plasma Display, please consult an Authorized Service Center.

Do not cover the ventilation holes.

- Doing so may cause the Plasma Display to overheat, which can cause fire or damage to the Plasma Display.

Transport only in upright position!

- Transporting the unit with its display panel facing upright or downward may cause damage to the internal circuitry.

If using the pedestal (optional accessory), leave a space of 12.0" (30 cm) or more at the top, left and right, and 8.0" (20 cm) or more at the rear, and also keep the space between the bottom of the display and the floor surface. If using some other setting-up method, follow the manual of it. (If there is no specific indication of installation dimension in the installation manual, leave a space of 12.0" (30 cm) or more at the top, bottom, left and right, and 8.0" (20 cm) or more at the rear.)

An apparatus with CLASS I construction shall be connected to a mains socket outlet with a protective earthing connection.

■ AC Power Supply Cord

The Plasma Display is designed to operate on 200-240 V AC, 50/60 Hz.

- Contact an electrician for the 200 V power supply engineering.

Ensure that the mains plug is easily accessible.

Do not use any power supply cord other than that provided with this unit.

- Doing so may cause fire or electric shocks.

Securely insert the power cord plug as far as it will go.

- If the plug is not fully inserted, heat may be generated which could cause fire. If the plug is damaged or the wall socket plate is loose, they should not be used.

Do not handle the power cord plug with wet hands.

- Doing so may cause electric shocks.

Do not do anything that might damage the power cable. When disconnecting the power cable, hold the plug, not the cable.

- Do not make any modifications, place heavy objects on, place near hot objects, heat, bend, twist or forcefully pull the power cable. Doing so may cause damage to the power cable which can cause fire or electric shock. If damage to the cable is suspected, have it repaired at an Authorized Service Center.

If the Plasma Display will not be used for a long period of time, unplug the power cord from the wall outlet.

■ If problems occur during use

If a problem occurs (such as no picture or no sound), or if smoke or an abnormal odor is detected from the Plasma Display, unplug the power cord immediately.

- Continuous use of the Display under these conditions might cause fire or permanent damage to the unit. Have the Display evaluated at an Authorized Service Center. Services to the Display by any unauthorized personnel are strongly discouraged due to its high voltage dangerous nature.

If water or foreign objects get inside the Plasma Display, if the Plasma Display is dropped, or if the cabinet becomes damaged, disconnect the power cord plug immediately.

- A short may occur, which could cause fire. Contact an Authorized Service Center for any repairs that need to be made.

Maintenance

The front of the display panel has been specially treated. Wipe the panel surface gently using only a cleaning cloth or a soft, lint-free cloth.

- If the surface is particularly dirty, wipe with a soft, lint-free cloth which has been soaked in pure water or water in which neutral detergent has been diluted 100 times, and then wipe it evenly with a dry cloth of the same type until the surface is dry.
- Do not scratch or hit the surface of the panel with fingernails or other hard objects, otherwise the surface may become damaged. Furthermore, avoid contact with volatile substances such as insect sprays, solvents and thinner, otherwise the quality of the surface may be adversely affected.

If the cabinet becomes dirty, wipe it with a soft, dry cloth.

- If the cabinet is particularly dirty, soak the cloth in water to which a small amount of neutral detergent has been added and then wring the cloth dry. Use this cloth to wipe the cabinet, and then wipe it dry with a dry cloth.
- Do not allow any detergent to come into direct contact with the surface of the Plasma Display. If water droplets get inside the unit, operating problems may result.
- Avoid contact with volatile substances such as insect sprays, solvents and thinner, otherwise the quality of the cabinet surface may be adversely affected or the coating may peel off. Furthermore, do not leave it for long periods in contact with articles made from rubber or PVC.

Accessories

Accessories Supplied

Check that you have the Accessories and items shown

Operating Instruction book

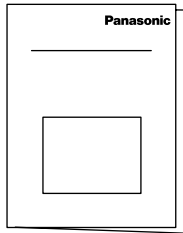

Remote Control Transmitter EUR7636070R



Batteries for the Remote Control Transmitter (AA Size x 2)

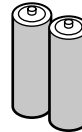

Fixing bands x 2

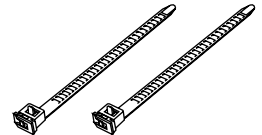

AC cord

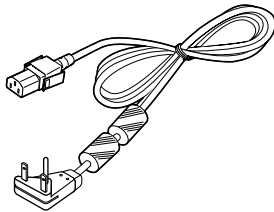

Allen wrench



Eyebolt cap x 3

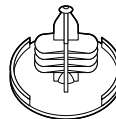

Blind sheet x 1

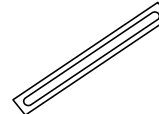

Remote Control Batteries

Requires two AA batteries.

1. Pull and hold the hook, then open the battery cover.

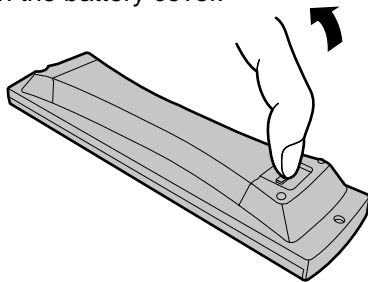

2. Insert batteries - note correct polarity (+ and -).

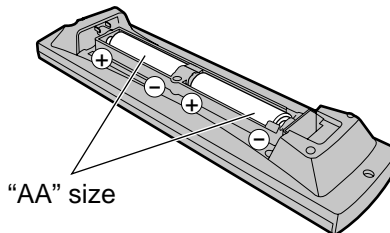

3. Replace the cover.

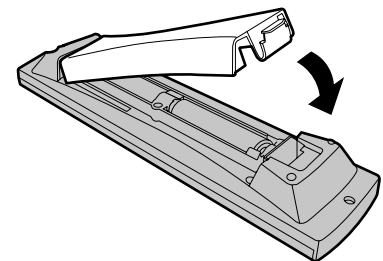

Helpful Hint:

For frequent remote control users, replace old batteries with Alkaline batteries for longer life.

Precaution on battery use

Incorrect installation can cause battery leakage and corrosion that will damage the remote control transmitter. Disposal of batteries should be in an environment-friendly manner.

Observe the following precautions:

1. Batteries should always be replaced as a pair. Always use new batteries when replacing the old set.
2. Do not combine a used battery with a new one.
3. Do not mix battery types (example: "Zinc Carbon" with "Alkaline").
4. Do not attempt to charge, short-circuit, disassemble, heat or burn used batteries.
5. Battery replacement is necessary when the remote control acts sporadically or stops operating the Plasma Display.
6. Do not burn or breakup batteries.
Batteries must not be exposed to excessive heat such as sunshine, fire or the like.

Connections

AUDIO OUT Terminals connection

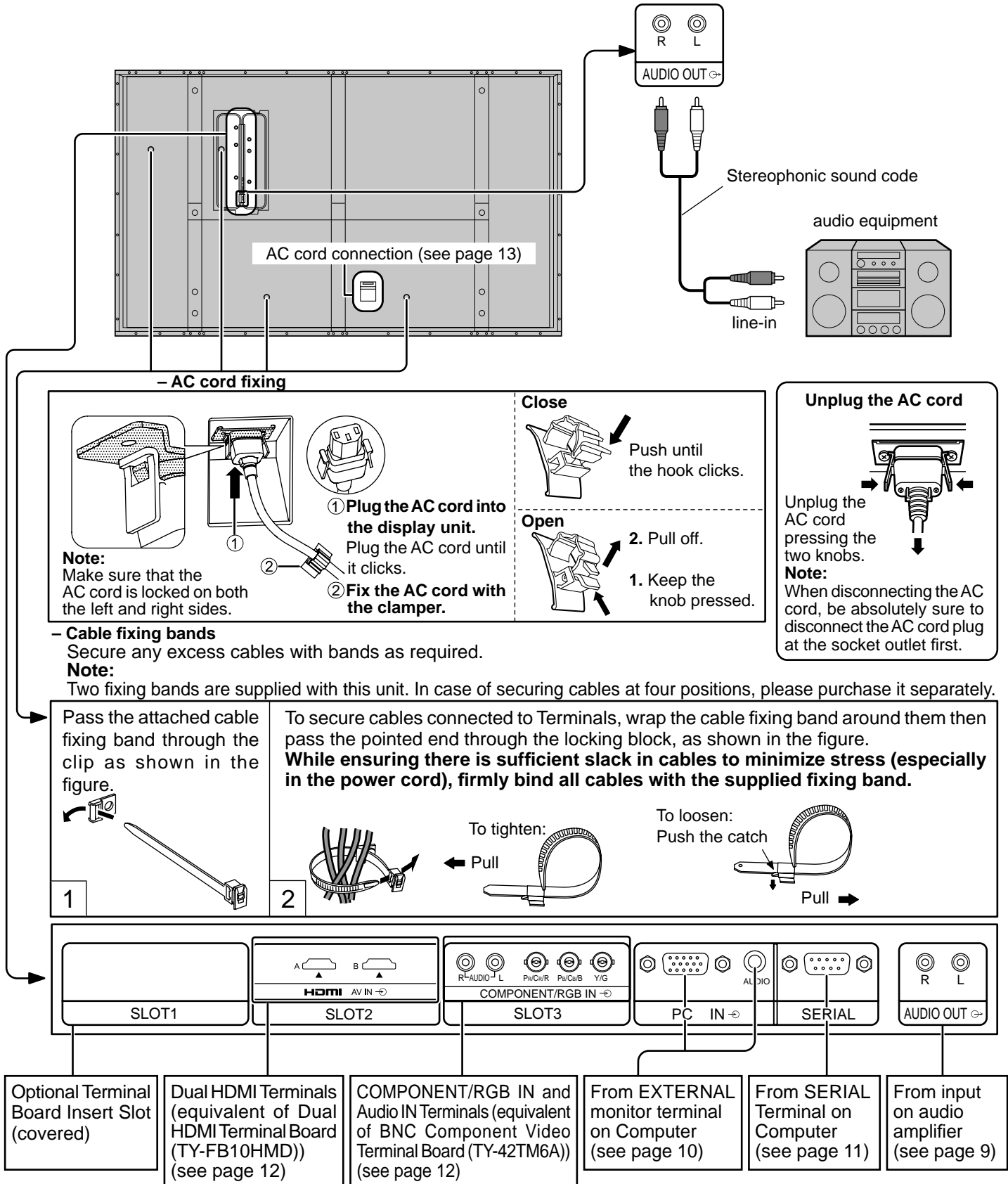

Note: At factory shipment, Terminal boards are installed in SLOT 2 and SLOT 3.

PC Input Terminals connection

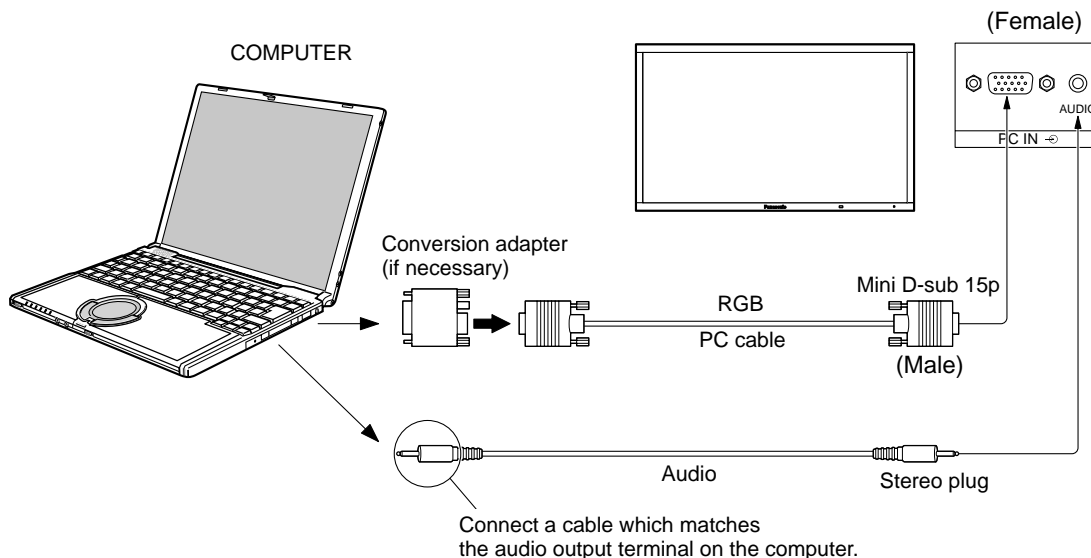

Notes:

- With regard to the typical PC input signals that are described in the applicable input signals list (see page 62), adjustment values such as for the standard picture positions and sizes have already been stored in this unit. You can add up to eight PC input signal types that are not included in the list.
- Computer signals which can be input are those with a horizontal scanning frequency of 15 to 110 kHz and vertical scanning frequency of 48 to 120 Hz. (However, the image will not be displayed properly if the signals exceed 1,200 lines.)
- The display resolution is a maximum of 1,440 × 1,080 dots when the aspect mode is set to “4:3”, and 1,920 × 1,080 dots when the aspect mode is set to “FULL”. If the display resolution exceeds these maximums, it may not be possible to show fine detail with sufficient clarity.
- The PC input terminals are DDC2B-compatible. If the computer being connected is not DDC2B-compatible, you will need to make setting changes to the computer at the time of connection.
- Some PC models cannot be connected to the set.
- There is no need to use an adapter for computers with DOS/V compatible Mini D-sub 15P terminal.
- The computer shown in the illustration is for example purposes only.
- Additional equipment and cables shown are not supplied with this set.
- Do not set the horizontal and vertical scanning frequencies for PC signals which are above or below the specified frequency range.
- Component Input is possible with the pin 1, 2, 3 of the Mini D-sub 15P Connector.
- Change the “COMPONENT/RGB-IN SELECT” setting in the “SET UP” menu to “COMPONENT” (when COMPONENT signal connection) or “RGB” (when RGB signal connection). (see page 50)

Signal Names for Mini D-sub 15P Connector

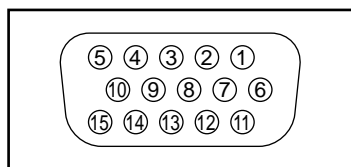

Pin Layout for PC Input Terminal

| Pin No. | Signal Name | Pin No. | Signal Name | Pin No. | Signal Name |
|---------|-------------------------------------|---------|--------------|---------|--------------------|
| ① | R (P _R /C _R) | ⑥ | GND (Ground) | ⑪ | NC (not connected) |
| ② | G (Y) | ⑦ | GND (Ground) | ⑫ | SDA |
| ③ | B (P _B /C _B) | ⑧ | GND (Ground) | ⑬ | HD/SYNC |
| ④ | NC (not connected) | ⑨ | +5 V DC | ⑭ | VD |
| ⑤ | GND (Ground) | ⑩ | GND (Ground) | ⑮ | SCL |

SERIAL Terminals connection

The SERIAL terminal is used when the Plasma Display is controlled by a computer.

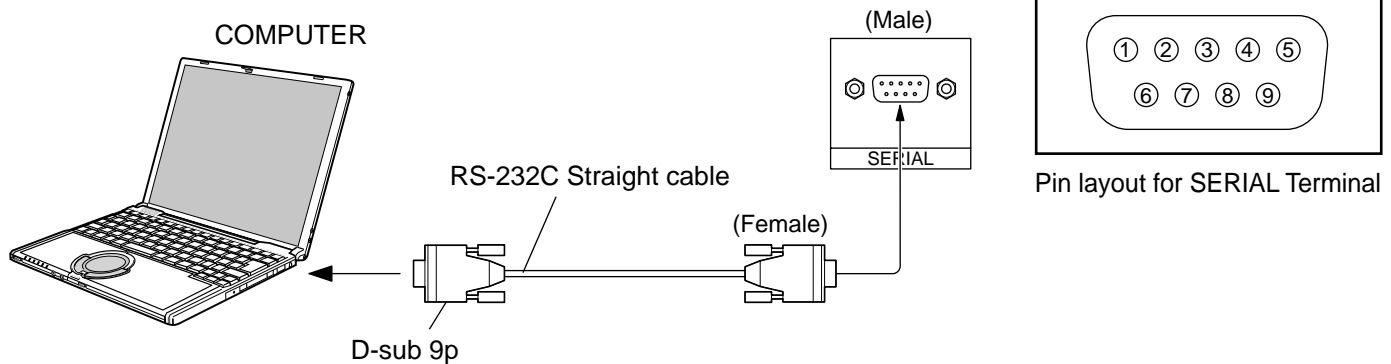

Notes:

- Use the RS-232C straight cable to connect the computer to the Plasma Display.
- The computer shown is for example purposes only.
- Additional equipment and cables shown are not supplied with this set.

The SERIAL terminal conforms to the RS-232C interface specification, so that the Plasma Display can be controlled by a computer which is connected to this terminal. The computer will require software which allows the sending and receiving of control data which satisfies the conditions given below. Use a computer application such as programming language software. Refer to the documentation for the computer application for details.

Communication parameters

| | |
|------------------------|-------------------|
| Signal level | RS-232C compliant |
| Synchronization method | Asynchronous |
| Baud rate | 9600 bps |
| Parity | None |
| Character length | 8 bits |
| Stop bit | 1 bit |
| Flow control | - |

Basic format for control data

The transmission of control data from the computer starts with a STX signal, followed by the command, the parameters, and lastly an ETX signal in that order. If there are no parameters, then the parameter signal does not need to be sent.

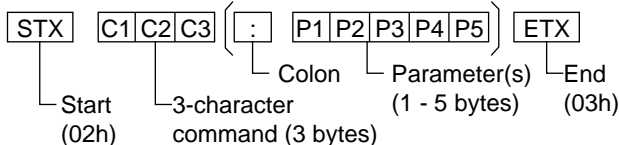

Notes:

- If multiple commands are transmitted, be sure to wait for the response for the first command to come from this unit before sending the next command.
- If an incorrect command is sent by mistake, this unit will send an "ER401" command back to the computer.
- SL1A, SL1B, SL2A and SL2B of Command IMS are available only when a dual input terminal board is attached.

Signal names for D-sub 9P connector

| Pin No. | Details |
|---------|-----------------------|
| ② | R X D |
| ③ | T X D |
| ⑤ | GND |
| ④ • ⑥ | Non use |
| ⑦ ⑧ | (Shorted in this set) |
| ① • ⑨ | NC |

These signal names are those of computer specifications.

Command

| Command | Parameter | Control details |
|---------|--------------|--|
| PON | None | Power ON |
| POF | None | Power OFF |
| AVL | ** | Volume 00 - 63 |
| AMT | 0 | Audio MUTE OFF |
| | 1 | Audio MUTE ON |
| IMS | None | Input select (toggle) |
| | SL1 | Slot1 input |
| | SL2 | Slot2 input |
| | SL3 | Slot3 input |
| | PC1 | PC input |
| | SL1A | Slot1 input (INPUT1A) |
| | SL1B | Slot1 input (INPUT1B) |
| | SL2A SL2B | Slot2 input (INPUT2A) Slot2 input (INPUT2B) |
| DAM | None | Screen mode select (toggle) |
| | ZOOM | ZOOM (For Video/SD/PC signal) |
| | FULL | FULL |
| | JUST | JUST (For Video/SD signal) |
| | NORM | 4:3 (For Video/SD/PC signal) |
| | SELF | Panasonic Auto (For Video signal) |
| | SJST | JUST (For HD signal) |
| | SNOM | 4:3 (For HD signal) |
| | SFUL | H-FILL (For HD signal) |
| | ZOM2 | ZOOM (For HD signal) |

With the power off, this display responds to PON command only.

HDMI connection

This unit has terminal boards equivalent to Dual HDMI Terminal Board (TY-FB10HMD) and BNC Component Video Terminal Board (TY-42TM6A) as standard equipment.

[Pin assignments and signal names]

| Pin No. | Signal | Pin No. | Signal |
|---------|----------------------|---------|---------------------------|
| ① | T.M.D.S Data2+ | ⑪ | T.M.D.S Clock Shield |
| ② | T.M.D.S Data2 Shield | ⑫ | T.M.D.S Clock- |
| ③ | T.M.D.S Data2- | ⑬ | CEC |
| ④ | T.M.D.S Data1+ | ⑭ | Reserved (N.C. on device) |
| ⑤ | T.M.D.S Data1 Shield | ⑮ | SCL |
| ⑥ | T.M.D.S Data1- | ⑯ | SDA |
| ⑦ | T.M.D.S Data0+ | ⑰ | DDC/CEC Ground |
| ⑧ | T.M.D.S Data0 Shield | ⑱ | +5V Power |
| ⑨ | T.M.D.S Data0- | | Hot Plug Detect |
| ⑩ | T.M.D.S Clock+ | | |

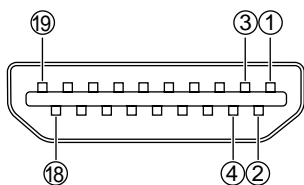

Note:

Additional equipment and HDMI cables shown are not supplied with this set.

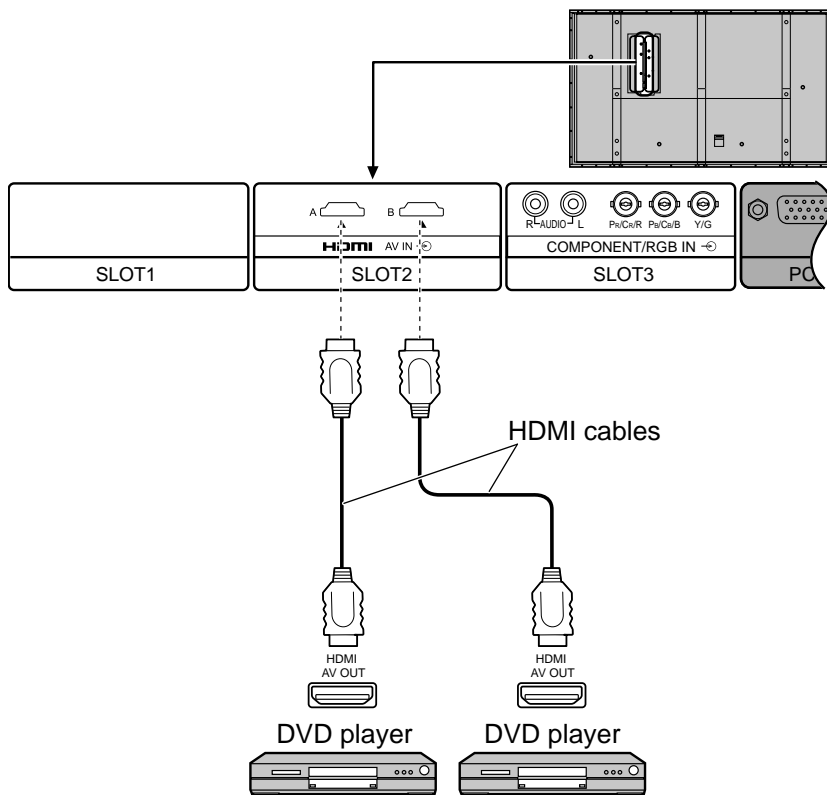

COMPONENT / RGB connection

Example of input signal source

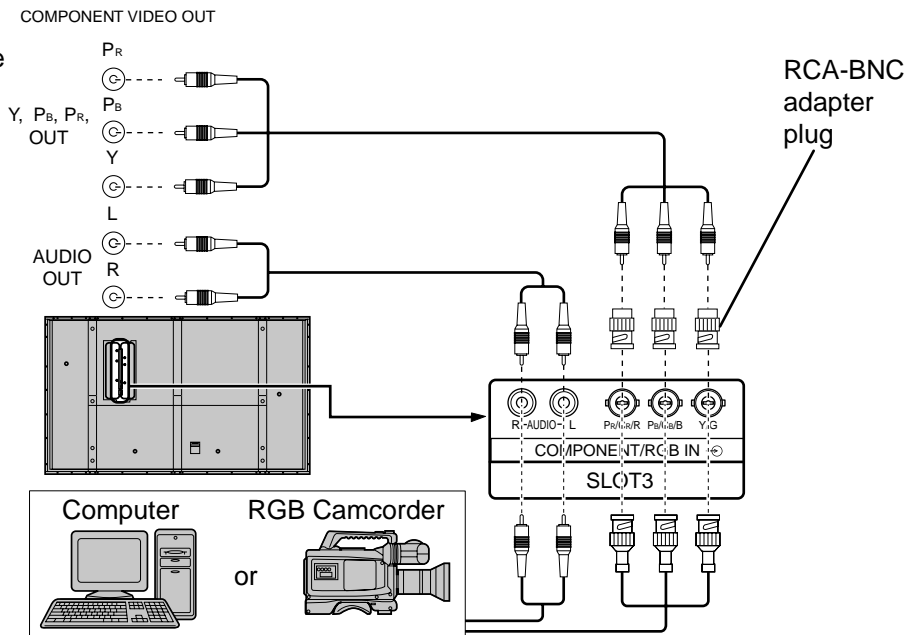
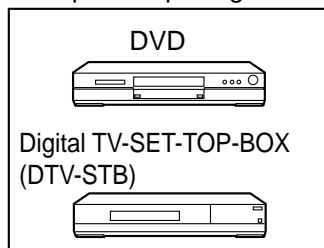

Notes:

- Change the "COMPONENT/RGB-IN SELECT" setting in the "SET UP" menu to "COMPONENT" (when COMPONENT signal connection) or "RGB" (when RGB signal connection). (see page 50)
- Additional equipment, cables and adapter plugs shown are not supplied with this set.
- SYNC ON G signal is needed. (see page 54)

Power ON / OFF

Connecting the AC cord plug to the Plasma Display.

Fix the AC cord plug securely to the Plasma Display with the clamber. (see page 9)

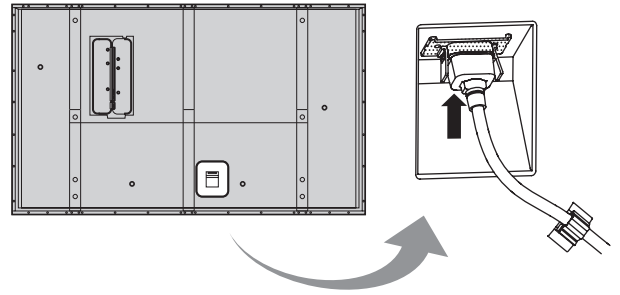

Connecting the plug to the Wall Outlet.

Note:

When disconnecting the AC cord, be absolutely sure to disconnect the AC cord plug at the socket outlet first.

Press the Power switch on the Plasma Display to turn the set on: Power-On.

Power Indicator: Green

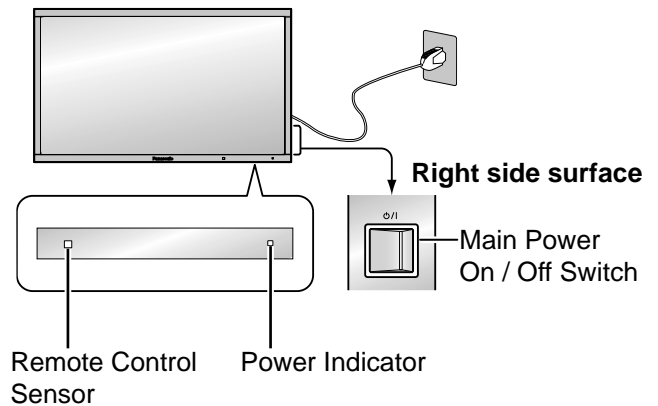

Press the  button on the remote control to turn the Plasma Display off.

Power Indicator: Red (standby)



Press the  button on the remote control to turn the Plasma Display on.

Power Indicator: Green

Turn the power to the Plasma Display off by pressing the  switch on the unit, when the Plasma Display is on or in standby mode.

Note:

During operation of the power management function, the power indicator turns orange in the power off state.

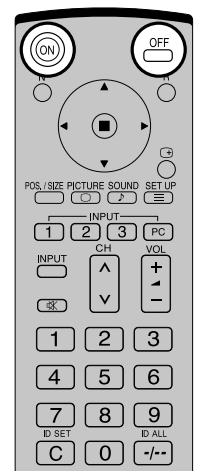

When first switching on the unit

Following screen will be displayed when the unit is turned on for the first time. Select the items with the remote control. Unit buttons are invalid.

OSD LANGUAGE

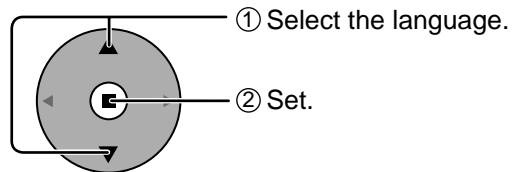

PRESENT TIME SETUP

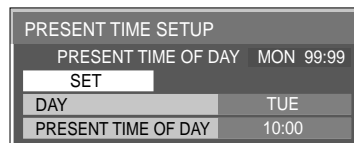
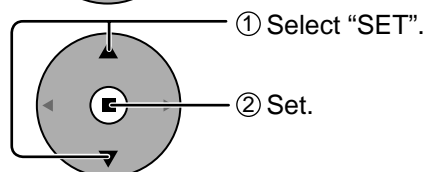
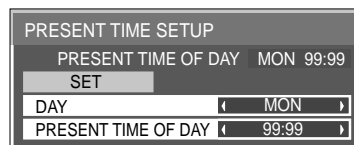
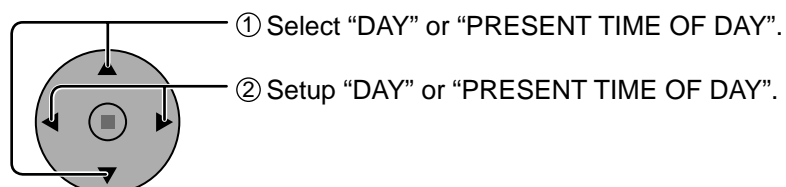

DISPLAY ORIENTATION

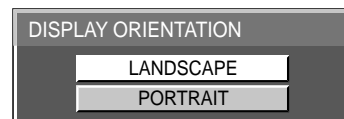
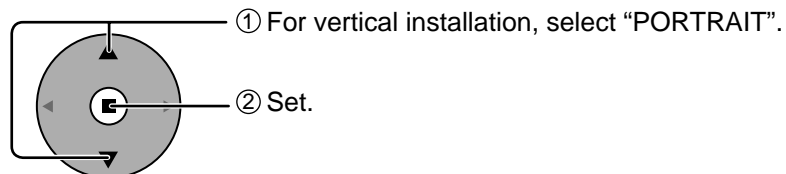

Notes:

- Once the items are set, the screens won't be displayed when switching on the unit next time.
- After the setting, the items can be changed in the following menus.
OSD LANGUAGE (see page 43)
PRESENT TIME SETUP (see page 36)
DISPLAY ORIENTATION (see page 44)

From the second time on, the below screen is displayed for a while (setting condition is an example).

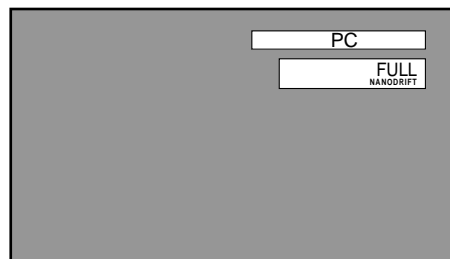

Selecting the input signal

Select the input signals to be connected by installing the optional Terminal Boards.

INPUT



Press to select the input signal to be played back from the equipment which has been connected to the Plasma Display.

Input signals will change as follows:



SLOT2 is for dual input so that you can select INPUT2A or INPUT2B for INPUT2.

INPUT2A : HDMI signal terminal in SLOT2

INPUT2B : HDMI signal terminal in SLOT2



Press the INPUT "1", "2", "3" or "PC" input mode selection button to select the INPUT mode.

Press **2** to switch the input mode between INPUT2A and INPUT2B.

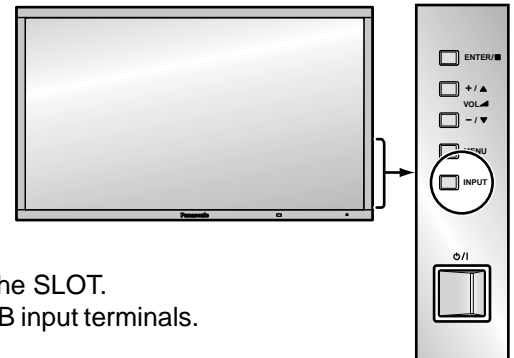
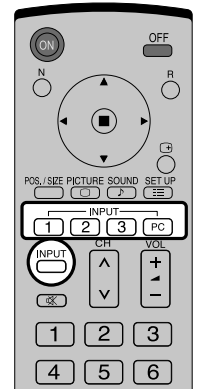

Notes:

- Selecting is also possible by pressing the INPUT button on the unit.
- Input terminal will not be selected if the terminal board is not installed into the SLOT.
- Select to match the signals from the source connected to the component/RGB input terminals. (see page 50)
- In 2 screen display, the same input mode cannot be selected for the main picture and sub picture.
- Image retention (image lag) may occur on the plasma display panel when a still picture is kept on the panel for an extended period. The function that darkens the screen slightly is activated to prevent image retention (see page 60), but this function is not the perfect solution to image retention.

Basic Controls

Main Unit

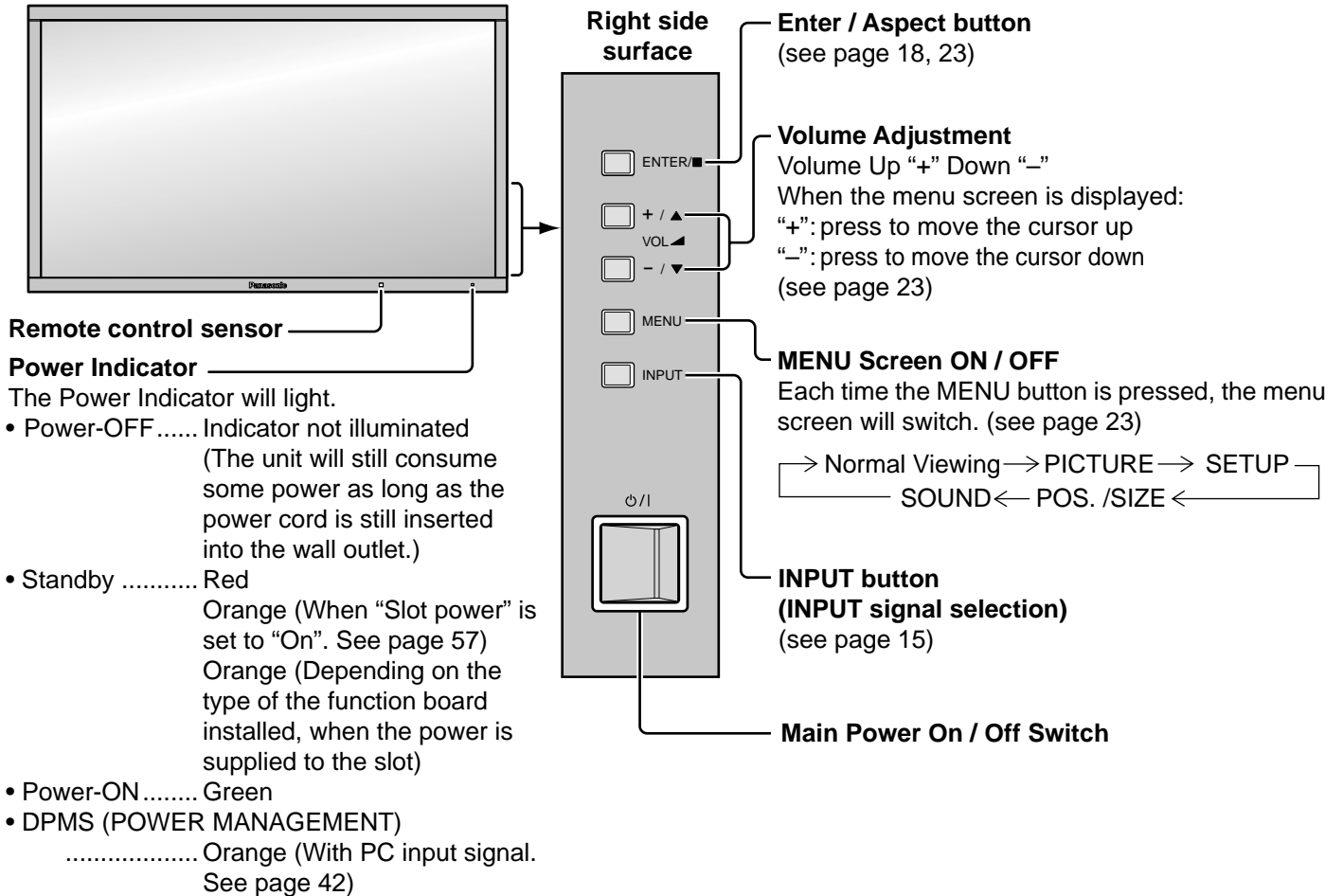

Remote Control Transmitter

R button (see page 23)
Press the R button to return to previous menu screen.

Standby (ON / OFF) button
The Plasma Display must first be plugged into the wall outlet and turned on at the power switch (see page 13). Press ON to turn the Plasma Display On, from Standby mode. Press OFF to turn the Plasma Display Off to Standby mode.

N button
(see page 27, 28, 29, 35)

POSITION buttons

ACTION button
Press to make selections.

POS. /SIZE button
(see page 25)

PICTURE button
(see page 28)

INPUT button
Press to select INPUT1, INPUT2, INPUT3 and PC input SLOTS sequentially. (see page 15)
When a dual input terminal board is attached, A or B is displayed depending on the selected input signal. (Ex. INPUT1A, INPUT1B)

Sound mute On / Off
Press this button to mute the sound. Press again to reactivate sound. Sound is also reactivated when power is turned off or volume level is changed.

Numeric buttons
(see page 46)

ASPECT button
Press to adjust the aspect.
(see page 18)

SURROUND button
The surround setting switches on and off each time the SURROUND button is pressed.
The benefits of surround sound are enormous. You can be completely enveloped in sound; just as if you were at a concert hall or cinema.

ON ← → OFF

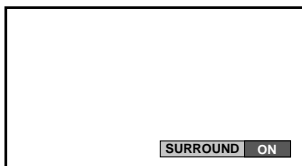

Status button
Press the "Status" button to display the current system status.

- ① Input label
- ② Aspect mode (see page 18)
NANODRIFT SAVER operating (see page 40)
- ③ Off timer
The off timer indicator is displayed only when the off timer has been set.
- ④ Clock display (see page 57)

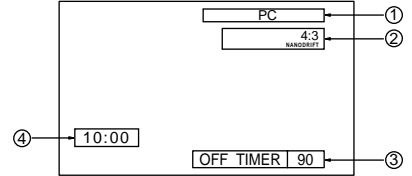

SET UP button (see page 23)

SOUND button (see page 35)

DIRECT INPUT buttons
Press the INPUT "1", "2", "3" or "PC" input mode selection button to select the INPUT mode. (see page 15)
This button is used to switch directly to INPUT mode.

Channel Adjustment
This button cannot be used for this model.

Volume Adjustment
Press the Volume Up "+" or Down "-" button to increase or decrease the sound volume level.

OFF TIMER button
The Plasma Display can be preset to switch to stand-by after a fixed period. The setting changes to 30 minutes, 60 minutes, 90 minutes and 0 minutes (off timer cancelled) each time the button is pressed.

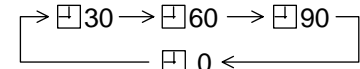

When three minutes remain, "OFF TIMER 3" will flash.
The off timer is cancelled if a power interruption occurs.

Remote ID lock (see page 46)

Digital Zoom (see page 22)

MULTI Window buttons
(see page 19)

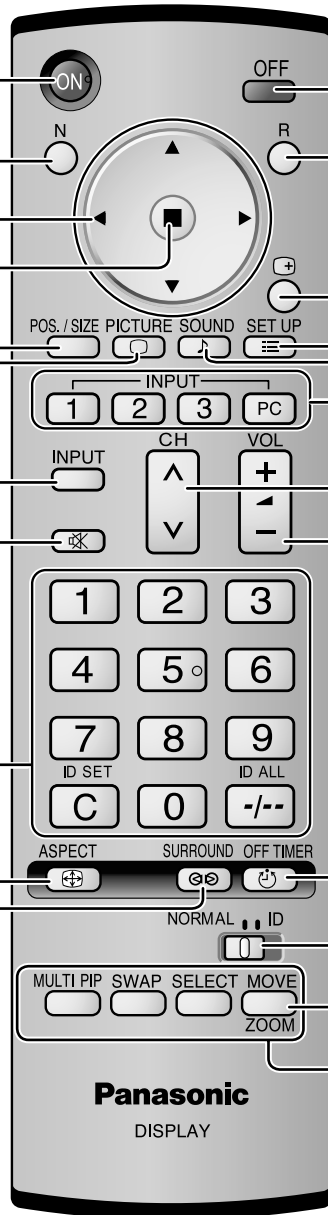

ASPECT Controls

The Plasma Display will allow you to enjoy viewing the picture at its maximum size, including wide screen cinema format picture.

Note:

Be aware that if you put the display in a public place for commercial purposes or a public showing and then use the aspect mode select function to shrink or expand the picture, you may be violating the copyright under copyright law. It is prohibited to show or alter the copyrighted materials of other people for commercial purposes without the prior permission of the copyright holder.

ASPECT



Press repeatedly to move through the aspect options:
For details about the aspect mode, please see "List of Aspect Modes" (page 61).

For VIDEO (S VIDEO) signal input:

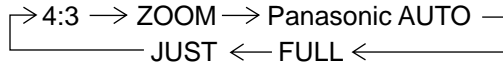

Note:

When selecting an input slot that attaches BNC Dual Video Terminal Board (TY-FB9BD), Panasonic AUTO cannot be selected.

The aspect mode changes each time the ENTER button is pressed.

[from the unit]

Right side surface

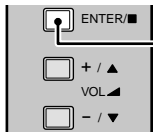

For PC signal input:



For SD signal input (525 (480) / 60i • 60p, 625 (575) / 50i • 50p):

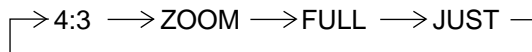

For HD signal input [1125 (1080) / 60i • 50i • 60p • 50p • 24p • 25p • 30p • 24sF, 1250 (1080) / 50i, 750 (720) / 60p • 50p]:



[During MULTI PIP Operations]

• Picture and Picture, Picture in Picture :

• Others : Aspect switching is not possible.

Notes:

- Panasonic AUTO can be selected only during Video signal input.
- The aspect mode is memorized separately for each input terminal.
- Do not allow the picture to be displayed in 4:3 mode for an extended period, as this can cause a permanent image retention to remain on the Plasma Display Panel.

Panasonic AUTO

The display will automatically become enlarged (depending on the picture source), allowing you to view the picture at its maximum size.

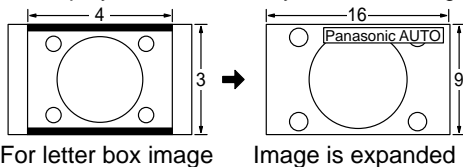

For letter box image

Image is expanded

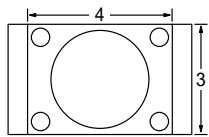

For a 4:3 image

Changes in accordance with the Panasonic AUTO mode setting (see page 52).

Notes:

- Panasonic AUTO mode is designed to automatically adjust the aspect ratio to handle a mix of 16:9 and 4:3 program material. Certain 4:3 program material, such as stock market data screens, may occasionally cause the image size to change unexpectedly. When viewing such programs, it is recommended that the ASPECT be set to 4:3.
- If adjusting the PICTURE V-POS/V-SIZE in Panasonic AUTO with FULL mode, the adjustment is not memorized. When exiting the mode, the screen will return to a former adjustment.

All Aspect mode

Set "All Aspect" to "On" in Options menu to enable the extended aspect mode (page 57). When All Aspect mode, the aspect mode of pictures is switched as follows. For details about the aspect mode, please see "List of Aspect Modes" (page 61).

For VIDEO (S VIDEO) signal input:

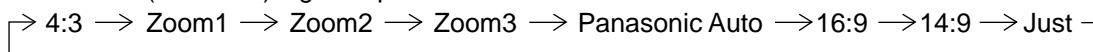

Notes:

- When selecting an input slot that attaches BNC Dual Video Terminal Board (TY-FB9BD), Panasonic Auto cannot be selected.
- In All Aspect mode, "Panasonic AUTO" is displayed as "Panasonic Auto".

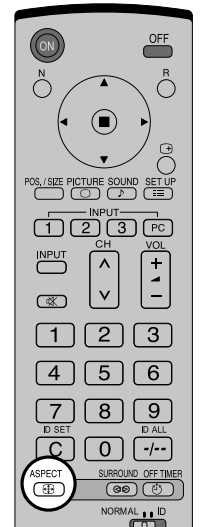

For PC signal input:

→ 4:3 → Zoom → 16:9

For SD signal input (525 (480) / 60i • 60p, 625 (575) / 50i • 50p):

→ 4:3 → Zoom1 → Zoom2 → Zoom3 → 16:9 → 14:9 → Just

For HD signal input [1125 (1080) / 60i • 50i • 60p • 50p • 24p • 25p • 30p • 24sF, 1250 (1080) / 50i, 750 (720) / 60p • 50p]:

→ 4:3 Full → Zoom1 → Zoom2 → Zoom3 → 16:9 → 14:9 → Just1 → Just2 → 4:3 (1) → 4:3 (2)

MULTI PIP

You can display two pictures, such as a video image and computer image, in a two-screen display. (Use the remote control for this operation. It cannot be performed with the buttons on the main unit.)

MULTI PIP SETUP

Set the functions and mode for two-screen display in "MULTI PIP SETUP" in the SET UP menu. (see page 47)

Selecting the Display Mode

MULTI PIP

 Each time this button is pressed, the screen changes.

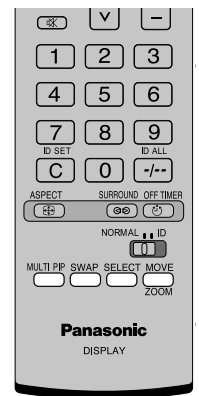

Note:

The screen changes in the same way when "DISPLAY MODE" in "MULTI PIP SETUP" is changed. (see page 47)

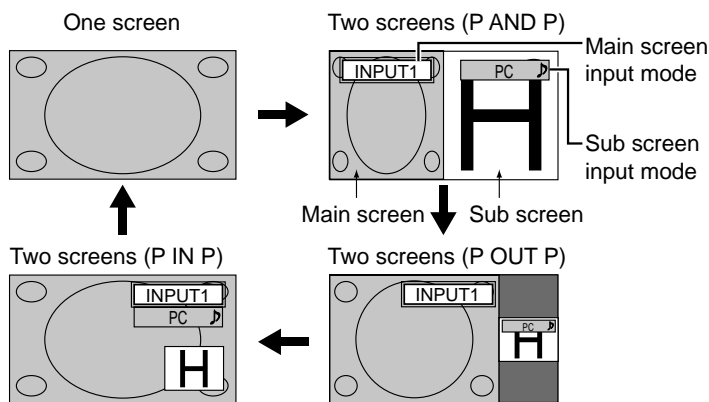

During PIP:

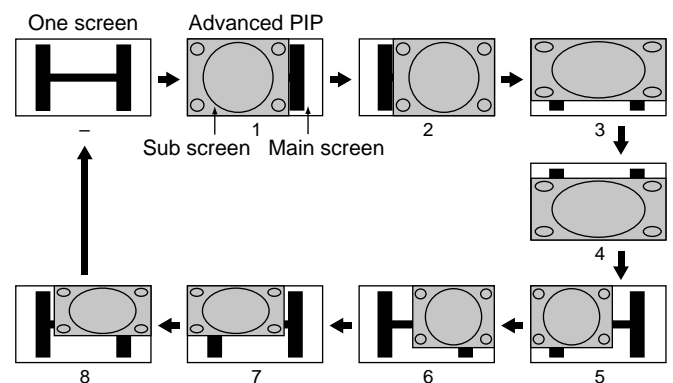

During Advanced PIP:



Note:

ASPECT  and  button operations are not available during advanced PIP.

MULTI PIP

During Blend PIP (Composite Screen Function) :

A composite picture is displayed with the sub screen positioned over the main screen. For example, text data such as a computer image can be displayed as a caption over a movie or still image.

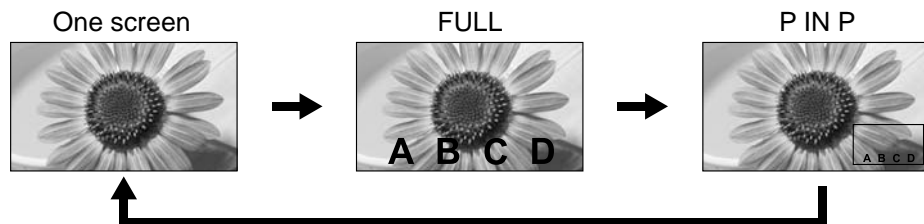

Transparent Function and Insertion Function

Two functions are available for blend PIP: the transparent function and the insertion function. Set these functions with "TRANSPARENCY" or "INSERT" in "MULTI PIP SETUP". (see page 47)

Transparent Function

Data such as text are displayed transparently on the background image.



Insertion Function

The sub screen image is divided into transparent and non-transparent areas, and only the non-transparent areas are inserted and displayed on the background image.



Note:

Be aware that if you put the display in a public place for commercial purposes or a public showing and then use the blend PIP function to make a composite screen display, you may be violating the copyright under copyright law. It is prohibited to show or alter the copyrighted materials of other people for commercial purposes without the prior permission of the copyright holder.

Swapping Screens

SWAP

Each time this button is pressed, the main screen and sub screen are swapped.

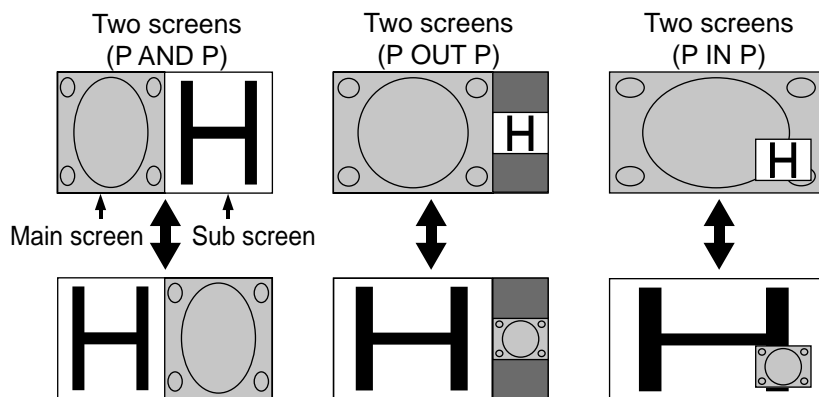

Selecting the Target Screen for Operations

SELECT



Each time this button is pressed, the target screen for operations changes.

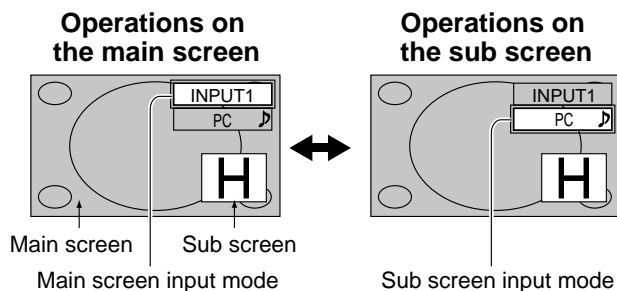

Notes:

- When operations are performed for the sub screen, the sub screen audio is played.
- If no operations are performed, the operation target returns to the main screen after about 5 seconds*. You can also return to main screen operations by operating the remote control buttons (except for ).
- * It takes more than 5 seconds if a slot mounted with a Dual HDMI Terminal Board (TY-FB10HMD) is selected.

Selecting the Sub Screen Position (During P IN P Display)

MOVE



Each time this button is pressed, the sub screen position changes.

ZOOM

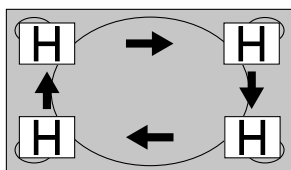

Note:

Some sub screen positions may hide the display of the menu screen.

Notes:

- Do not use the two-screen display for a long time. It will cause a permanent image retention to remain on the screen.
- If "INPUT lock" in Options menu is set to other than "Off", MULTI PIP function isn't available.
- Sound output is from the picture which is selected in AUDIO OUT (PIP) (see page 35).
- In two-screen display, the same input mode cannot be selected for the main picture and sub picture.
- The main picture and sub picture are processed by different circuits, resulting in a slight difference in the clarity of the pictures. There may also be a difference in the picture quality of the sub picture depending on the type of signals displayed on the main picture and depending on the two-screen display mode.
- Due to the small dimensions of the sub pictures, these sub pictures cannot be shown in detail.
- Computer screen picture is displayed in a simplified format, and it may not be possible to discern details on them satisfactorily.
- Following combinations of two analog signals cannot be displayed simultaneously; Component - Component, Component - PC (RGB), PC (RGB) - Component, PC (RGB) - PC (RGB)
- 2k1k signals that are received with the Dual Link HD-SDI Terminal Board (TY-FB11DHD) cannot be displayed in two-screen display.

Digital Zoom

This displays an enlargement of the designated part of the displayed image.

1 Display the operation guide.

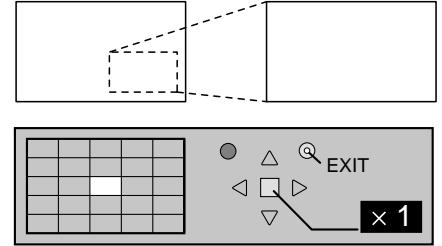
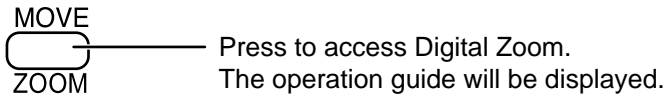

During Digital Zoom, only the following buttons can be operated.

[Remote control]

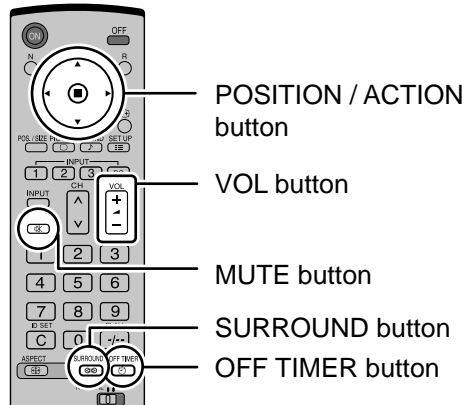

[Unit]

Right side surface

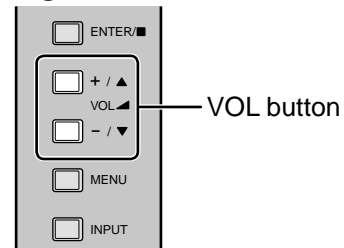

2 Select the area of the image to be enlarged.

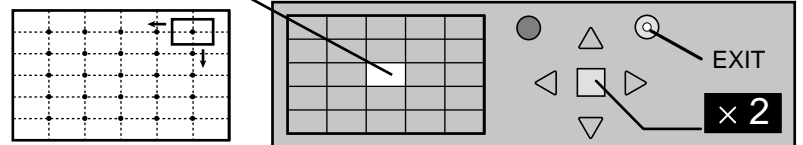
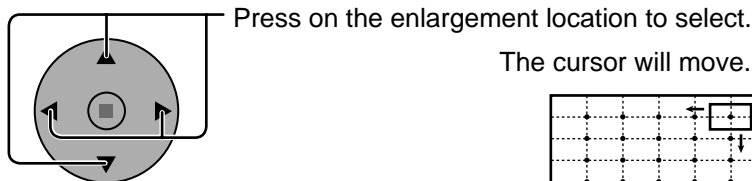

3 Select the magnification required for the enlarged display.

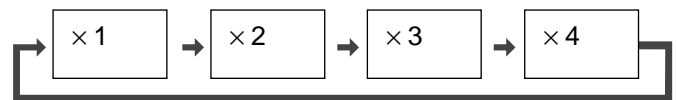
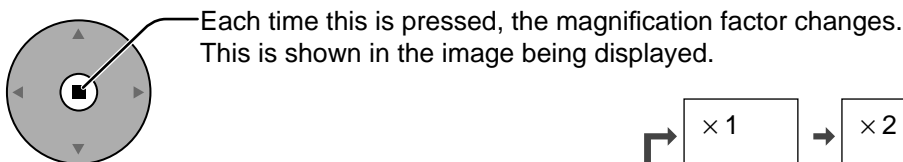

4 Return to normal display (quit Digital Zoom).

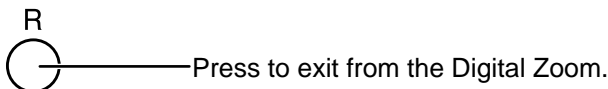

Notes:

- When power goes OFF (including "Off Timer" operation), Digital Zoom terminates.
- The Digital Zoom function cannot be selected while in the following operation state:
 "Multi-viewer" (P AND P, P OUT P, P IN P) operation. (see page 19)
 When MULTI DISPLAY SETUP is ON (see page 45).
 When PORTRAIT SETUP is ON (see page 48).
 When SCREENSAVER (except for NEGATIVE IMAGE) is running. (see page 37)
- While Digital Zoom is in operation, "Adjusting POS. /SIZE" cannot be used.

On-Screen Menu Displays

Remote Control

Unit

1 Display the menu screen.



Press to select.
(Example: PICTURE menu)



Press several times.

Each time the MENU button is pressed, the menu screen will switch.

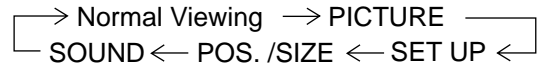

2 Select the item.

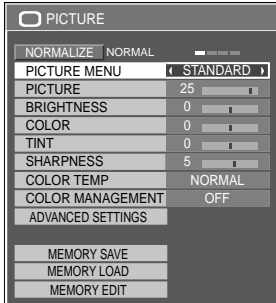

(Example: PICTURE menu)

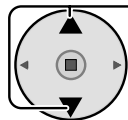

Select.

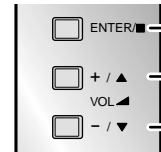

② Press.

① Select.

3 Set.

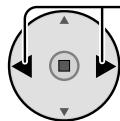

Set.

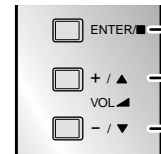

② Press.

① Set.

4 Exit the menu.



Press. $\overset{R}{\bigcirc}$
Press \bigcirc to return to the previous menu.



Press several times.

On-Screen Menu Displays

Overview

Note: Menu that cannot be adjusted is grayout. Adjustable menu changes depending on signal, input and menu setting.

POS./SIZE

NORMALIZE NORMAL

AUTO SETUP

H-POS (0)

H-SIZE (0)

V-POS (0)

V-SIZE (0)

DOT CLOCK (0)

CLOCK PHASE (0)

1:1 PIXEL MODE (OFF)

(see page 25-27)

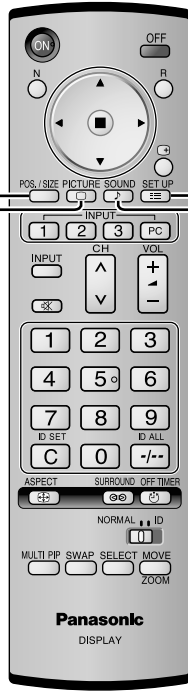

SET UP 1/2

SIGNAL

SCREENSAVER

EXTENDED LIFE SETTINGS

COMPONENT/RGB-IN SELECT (RGB)

INPUT LABEL (PC)

POWER SAVE (OFF)

STANDBY SAVE (OFF)

POWER MANAGEMENT (OFF)

AUTO POWER OFF (OFF)

OSD LANGUAGE (ENGLISH (US))

SET UP 2/2

MULTI DISPLAY SETUP

MULTI PIP SETUP

PORTRAIT SETUP

SET UP TIMER

PRESENT TIME SETUP

DISPLAY ORIENTATION (LANDSCAPE)

(see page 36-54)

SIGNAL [VIDEO]

3D Y/C FILTER (NTSC) (ON)

COLOR SYSTEM (AUTO)

3:2 PULLDOWN (OFF)

Panasonic AUTO (4:3) (4:3)

REFRESH RATE (100 Hz)

NOISE REDUCTION (OFF)

(see page 51-54)

SCREENSAVER

PRESENT TIME OF DAY 99:99

START

FUNCTION (SCROLLING BAR ONLY)

MODE (OFF)

(see page 37, 38)

EXTENDED LIFE SETTINGS

EXPRESS SETTINGS

CUSTOM SETTINGS

RESET

(see page 39-41)

MULTI DISPLAY SETUP

MULTI DISPLAY SETUP (OFF)

HORIZONTAL SCALE (x2)

VERTICAL SCALE (x2)

SEAM HIDES VIDEO (OFF)

LOCATION (A1)

AI-SYNCHRONIZATION (OFF)

(see page 45, 46)

PICTURE

NORMALIZE NORMAL

PICTURE MENU (STANDARD)

PICTURE (25)

BRIGHTNESS (0)

COLOR (0)

TINT (0)

SHARPNESS (5)

COLOR TEMP (NORMAL)

COLOR MANAGEMENT (OFF)

ADVANCED SETTINGS

MEMORY SAVE

MEMORY LOAD

MEMORY EDIT

(see page 28, 29)

SOUND 1/2

NORMALIZE NORMAL

BASS (0)

MID (0)

TREBLE (0)

BALANCE (0)

SURROUND (OFF)

AUDIO OUT (PIP) (MAIN)

SDI SOUND OUTPUT 2/2

LEFT CHANNEL (CHANNEL 1)

RIGHT CHANNEL (CHANNEL 1)

SOUND OUT (OFF)

LEVEL METER (OFF)

(see page 35)

MULTI PIP SETUP

MULTI PIP (BLEND PIP)

DISPLAY MODE (—)

TRANSPARENCY (OFF)

TRANSPARENCY LEVEL (0%)

INSERT (OFF)

INSERT LEVEL (1)

(see page 47)

PORTRAIT SETUP

PORTRAIT SETUP (OFF)

SEAM HIDES VIDEO (OFF)

VIEWING AREA (16:9)

LOCATION (1)

AI-SYNCHRONIZATION (OFF)

(see page 48, 49)

ADVANCED SETTINGS

NORMALIZE NORMAL

BLACK EXTENSION (0)

INPUT LEVEL (0)

GAMMA (2.2)

AGC (OFF)

W/B HIGH R (0)

W/B HIGH G (0)

W/B HIGH B (0)

W/B LOW R (0)

W/B LOW G (0)

W/B LOW B (0)

(see page 28, 29)

SET UP TIMER

PRESENT TIME OF DAY 99:99

POWER ON FUNCTION (OFF)

POWER ON TIME (0:00)

POWER OFF FUNCTION (OFF)

POWER OFF TIME (0:00)

(see page 36)

PRESENT TIME SETUP

PRESENT TIME OF DAY MON 99:99



SET

DAY (MON)

PRESENT TIME OF DAY (99:99)

(see page 36)

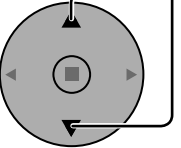
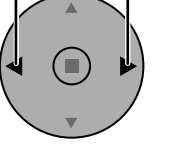
Adjusting POS. /SIZE

- 1  Press to display the POS. /SIZE menu.
- 2  Press to select the menu to adjust.
- 3  Press to adjust the menu.
- 4  Press to exit from adjust mode.

During "VIDEO (S VIDEO)", "Digital", "SDI" and "HDMI" input signal.

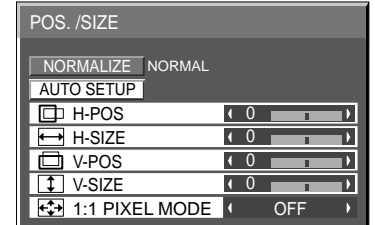

During "COMPONENT", "RGB" and "PC" input signal.

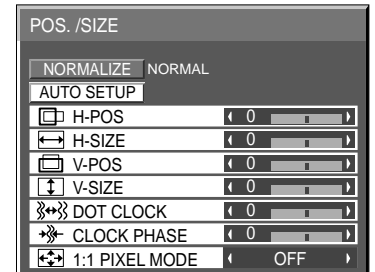

Notes:

- Unadjustable items are grayed out. Adjustable items differ depending on the input signal and the display mode.
- Adjustment details are memorized separately for different input signal formats. (Adjustments for component signals are memorized for 525 (480) / 60i · 60p, 625 (575) / 50i · 50p, 1125 (1080) / 60i · 50i · 60p · 50p · 24p · 25p · 30p · 24sF, 1250 (1080) / 50i, 750 (720) / 60p · 50p each, and RGB/PC/Digital signals are memorized for each frequency.)
- If a "Cue" or "Rew" signal from a VCR or DVD player is received, the picture position will shift up or down. This picture position movement cannot be controlled by the POS. /SIZE function.
- If adjusting the PICTURE V-POS / V-SIZE in Panasonic AUTO with FULL mode, the adjustment is not memorized. When exiting the mode, the screen will return to a former adjustment.

AUTO SETUP

H-POS/V-POS, H-SIZE/V-SIZE, DOT CLOCK and CLOCK PHASE are automatically adjusted when the RGB or PC signal is received.

This setting is enabled under the following conditions:

- This setting only support single screen display. Two screen display or multiple display are not supported.
- When "COMPONENT/RGB-IN SELECT" or "YUV/RGB-IN SELECT" in the "SET UP" menu (see page 52) is set to "RGB", this setting is enabled.
- When the signal is not PC format, this setting is enabled only if "OVER SCAN" (see page 26) is "OFF" or "1:1 PIXEL MODE" (see page 27) is "ON", and H-SIZE/V-SIZE is not automatically adjusted.

This setting will be invalid and will not work under the following conditions:

- Aspect is set to "JUST"
- "Display size" in the Options menu (see page 56) is set to "On"

Using Remote Control

Note:

To operate this function, please purchase remote controller sold separately.

Object model : N2QAYB000432

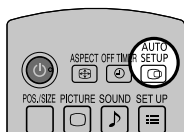

When  on the remote control is pressed, "AUTO SETUP" will be executed.

When AUTO SETUP does not work, "INVALID" is displayed.

Auto mode

When the "Auto Setup" is set to "Auto" in the Options menu (see page 57), automatic position adjustment starts:

- When the display power is turned ON.
- When the input signal is switched.

Adjusting POS. /SIZE

Notes:

- If the dot clock frequency is 162 MHz or higher, DOT CLOCK and CLOCK PHASE cannot be made.
- When digital RGB signal input, DOT CLOCK and CLOCK PHASE cannot be made.
- AUTO SETUP may not work when a cropped or dark image is input. In such case, switch to a bright image with borders and other objects are clearly shown, and then try auto setup again.
- Depending on the signal, out of alignment may occur after AUTO SETUP. Carry out fine tuning for the position/size as required.
- If AUTO SETUP cannot set properly for vertical frequency 60Hz XGA signal (1024x768@60Hz, 1280x768@60Hz, and 1366x768@60Hz), pre-selecting the individual signal in "XGA MODE" (see page 52) may results in correct AUTO SETUP.
- AUTO SETUP does not work well when a signal such as additional information is superimposed out of valid image period or intervals between synchronizing and image signals are short, or for image signal with tri-level synchronizing signal added.
- If AUTO SETUP cannot adjust correctly, select "NORMALIZE" once and press ACTION (■) then adjust POS. /SIZE manually.

H-POS

Adjust the horizontal position.

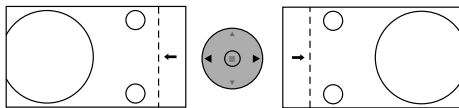

V-POS

Adjust the vertical position.

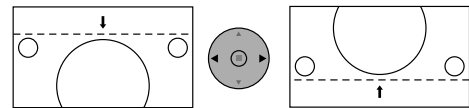

H-SIZE

Adjust the horizontal size.

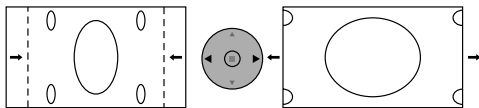

V-SIZE

Adjust the vertical size.

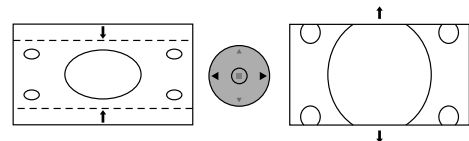

**DOT
CLOCK**

(During "COMPONENT", "RGB" and "PC" input signal)

Periodic striped pattern interference (noise) may occur when a striped pattern is displayed. If this happens, adjust so that any such noise is minimized.

**CLOCK
PHASE**

(During "COMPONENT", "RGB" and "PC" input signal)

Eliminate the flickering and distortion.

**OVER
SCAN**

Turn image over scan ON/OFF.

Configurable signals are as follows:

525i, 525p, 625i, 625p, 750/60p, 750/50p (Component Video, RGB, DVI, SDI, HDMI)

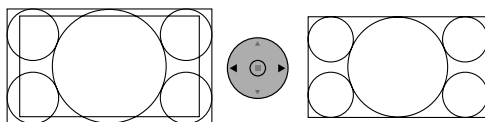

ON

OFF

Notes:

- When "OFF" is set, "H-SIZE" and "V-SIZE" cannot be adjusted.
- When the "Display size" is set to "On" in the Options menu, this setting will be invalid. (see page 56)

1:1 PIXEL MODE Adjusts the display size when 1125i, 1125p or 1250i signal is input.

Notes:

- Select ON when you would like to replay 1920 × 1080 input signal.
- Applicable input signal;
1125 (1080) / 50i · 60i · 24sF · 24p · 25p · 30p · 50p · 60p, 1250 (1080) / 50i
- Select OFF when flickering is shown around the image.
- H-SIZE and V-SIZE cannot be adjusted when ON is selected.

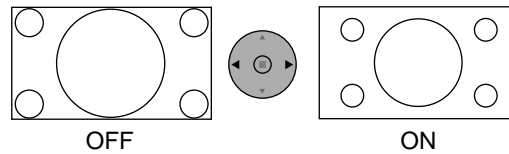

1:1 PIXEL MODE (2k1k) When the input signal is a 2k1k signal (2048×1080 / 24p, 2048×1080 / 24sF), the display size is adjusted as follows.
(For 2k1k signals)

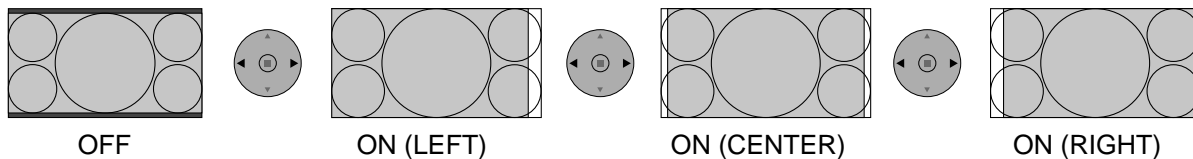

Note:

2k1k signals can only be received when the Dual Link HD-SDI Terminal Board (TY-FB11DHD) is installed.

Helpful Hint ( / NORMALIZE Normalization)

While the POS. /SIZE display is active, if either the N button on the remote control is pressed at any time or the ACTION (■) button is pressed during “NORMALIZE”, then all adjustment values are returned to the factory settings.

PICTURE Adjustments

1 PICTURE  Press to display the PICTURE menu.

2 Select to adjust each item.

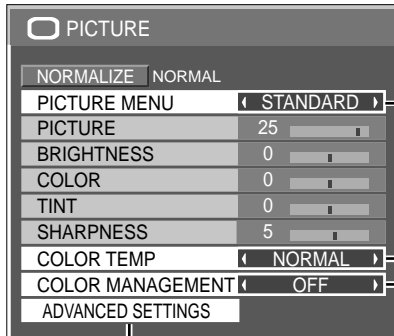
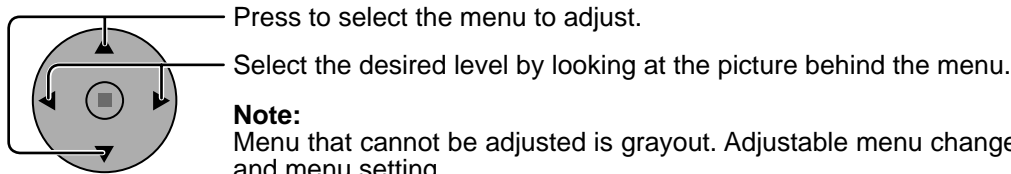
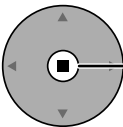

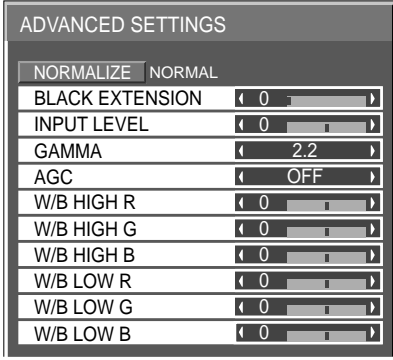

Press to enter Advanced Settings.

ADVANCED SETTINGS
Enables fine picture adjustment at a professional level (see next page).

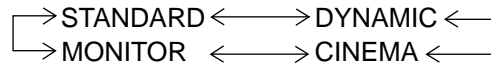

Press the left ◀ or right ▶ button to switch between modes.



STANDARD

For viewing in standard (evening lighting) environments. This menu selects the normal levels of BRIGHTNESS and PICTURE.

DYNAMIC

For viewing in brighter environments. This menu selects higher than normal levels of BRIGHTNESS and PICTURE.

CINEMA

Ideal for movies.

MONITOR

For use when creating broadcast or movie content. With this picture, even if the overall average picture level (APL) changes, the brightness of areas with the same signal level does not change.

Notes:

- When "MONITOR" is selected in PICTURE MENU, the following menu items cannot be set.
PICTURE menu: PICTURE
EXTENDED LIFE SETTINGS: PEAK LIMIT (see page 40)
SET UP menu: POWER SAVE (see page 42)
MULTI DISPLAY SETUP menu: AI-SYNCHRONIZATION (see page 46)
PORTRAIT SETUP menu: AI-SYNCHRONIZATION (see page 49)
- If you would like to change the picture and color of the selected PICTURE menu to something else, adjust using the items in the PICTURE menu. (see next page)

Press the left ◀ or right ▶ button to switch between modes.



COLOR MANAGEMENT ON

Enables vivid color adjustment automatically.

Helpful Hint (/ NORMALIZE Normalization)

While the "PICTURE" menu is displayed, if either the N button on the remote control is pressed at any time or the ACTION (■) button is pressed during "NORMALIZE", then all adjustment values are returned to the factory settings.

PICTURE Adjustments

| Item | Effect | Adjustments |
|------------|------------------------|--|
| PICTURE | Less More | Adjusts the proper picture contrast. |
| BRIGHTNESS | Darker Brighter | Adjusts for easier viewing of dark pictures such as night scenes and black hair. |
| COLOR | Less More | Adjusts color saturation. |
| TINT | Reddish Greenish | Adjusts for natural flesh tones. |
| SHARPNESS | Less More | Adjusts picture sharpness. |

Notes:

- “COLOR” and “TINT” settings cannot be adjusted for “RGB/PC” input signal.
- You can change the level of each function (PICTURE, BRIGHTNESS, COLOR, TINT, SHARPNESS) for each PICTURE MENU.
- The setting details for STANDARD, DYNAMIC and CINEMA respectively are memorized separately for each input terminal.
- The “TINT” setting can be adjusted for NTSC signal only during “VIDEO (S VIDEO)” input signal.
- In PICTURE, there is not a noticeable change even when contrast is increased with a bright picture or reduced with a dark picture.

ADVANCED SETTINGS

| Item | Effect | Details |
|-----------------|-----------------|--|
| BLACK EXTENSION | Less More | Adjusts the dark shades of the image in gradation. |
| INPUT LEVEL | Less More | Adjustment of parts which are extremely bright and hard to see. |
| GAMMA | Down Up | S+ CURVE*1 \longleftrightarrow S CURVE \longleftrightarrow 2.0 \longleftrightarrow 2.2 \longleftrightarrow 2.5 \longleftrightarrow 2.6*2 *1 When “PICTURE MENU” is set to “DYNAMIC”, GAMMA “S+ CURVE” can be selected. When 2k1k signals are received with the Dual Link HD-SDI Terminal Board (TY-FB11DHD), “S+ CURVE” cannot be selected. *2 When 2k1k signals are received with the Dual Link HD-SDI Terminal Board (TY-FB11DHD), GAMMA “2.6” can also be selected. |
| AGC | OFF ON | Increases the brightness of dark signal automatically. |
| W/B HIGH R | Less More | Adjusts the white balance for light red areas. |
| W/B HIGH G | Less More | Adjusts the white balance for light green areas. |
| W/B HIGH B | Less More | Adjusts the white balance for light blue areas. |
| W/B LOW R | Less More | Adjusts the white balance for dark red areas. |
| W/B LOW G | Less More | Adjusts the white balance for dark green areas. |
| W/B LOW B | Less More | Adjusts the white balance for dark blue areas. |

Notes:

- Carry out “W/B” adjustment as follows.
 1. Adjust the white balance of the bright sections using the “W/B HIGH R”, “W/B HIGH G” and “W/B HIGH B” settings.
 2. Adjust the white balance of the dark sections using the “W/B LOW R”, “W/B LOW G” and “W/B LOW B” settings.
 3. Repeat steps 1 and 2 to adjust.
 Steps 1 and 2 affect each other’s settings, so repeat each step in turn to make the adjustment.
- The adjustment values are memorized separately for each input terminal.
- The adjustment range values should be used as an adjustment reference.

Helpful Hint (/ NORMALIZE Normalization)

On the remote control unit, while the “ADVANCED SETTINGS” menu is displayed, if either the N button is pressed at any time or the ACTION () button is pressed during “NORMALIZE”, then all adjustment values are returned to the factory settings.

Picture Profiles

Up to 8 combinations of picture adjustment values (in the PICTURE menu and ADVANCED SETTINGS) can be stored in the display memory as profiles and applied as needed, for a convenient way to enjoy your preferred picture settings.

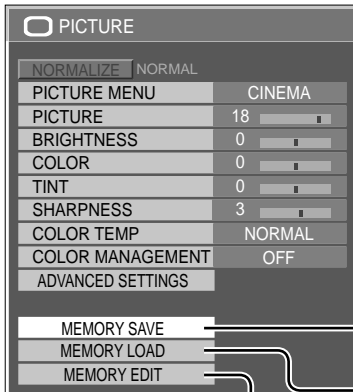

Save profiles (page 31)
Load profiles (page 32)
Edit profiles (page 32)

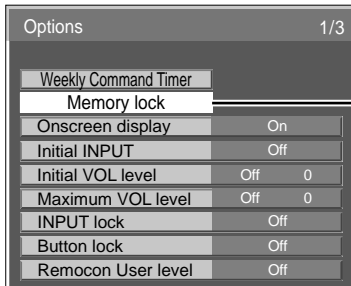
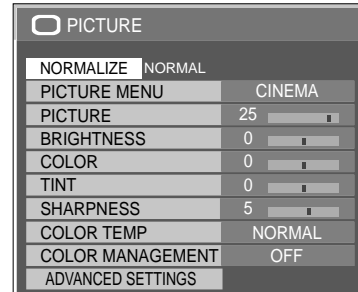

Lock profiles (page 33, 34)

Edit the profile
Delete or rename the profile

Locked profile

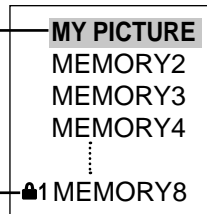

Save profiles

Save the picture adjustment values in the MEMORY1 profile

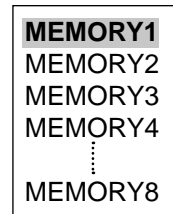

Load the profile

Apply the MEMORY1 profile



Original picture



Custom picture

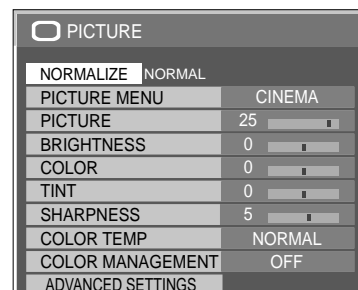
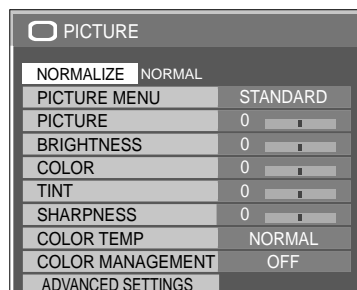

Saving profiles

Follow these steps to save picture adjustment values as profiles.

Note:

When the settings are locked in “EXTENDED LIFE SETTINGS”, profiles cannot be saved.

1 Specify the picture quality in the PICTURE menu and ADVANCED SETTINGS. (see page 28, 29)

2 In the PICTURE menu, select “MEMORY SAVE”.



3 Select a profile name for saving the picture adjustment values.



Profiles are labeled with these icons to indicate their locked status. (see page 33)

[] , []: Settings can be saved in this profile.

[1] , [2]: Settings cannot be saved in this profile.

4 Select “OK”.

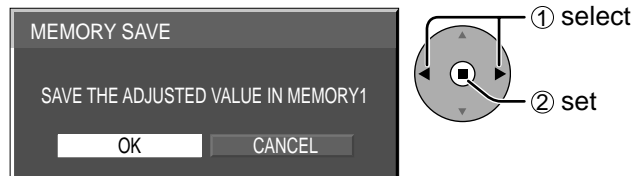

5 Enter a name for the profile.

[Entering profile names]

Profile names can be up to 16 characters.

To enter text, select characters in the on-screen keyboard.

Edit the default profile name in the text box as desired.

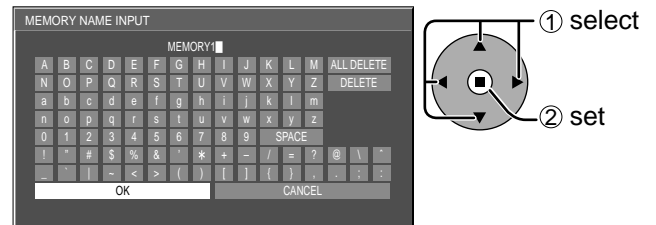

Example: Specifying “MY PICTURE”

① Select “ALL DELETE”.



All text is deleted.

To delete individual characters, select “DELETE”.

② Select “M”.



Repeat this process to enter the next character.

③ Select “Y”.



④ Select “SPACE”.



6 When you finished entering the profile name, select “OK”.

To cancel saving the profile, select “CANCEL”.

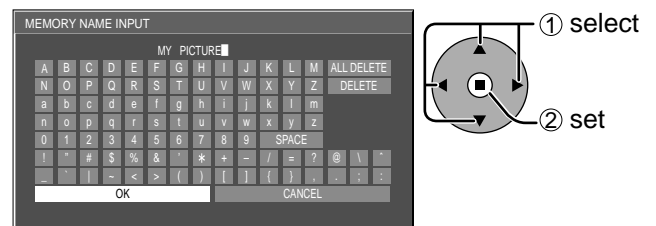

Loading profiles

Load profiles and apply the picture adjustment values to the display as follows.

Notes:

- Loaded profiles are stored in memory according to the selected input interface (SLOT1, 2, 3 or PC IN). (see page 15)
- When the settings are locked in "EXTENDED LIFE SETTINGS", profiles cannot be loaded.

1 In the PICTURE menu, select "MEMORY LOAD".



2 Select the profile to load.



Profiles are labeled with these icons to indicate their locked status. (see page 33)

Editing profiles

Delete or rename profiles as follows.

<Deleting profiles>

Note:

Locked profiles cannot be deleted.

1 In the PICTURE menu, select "MEMORY EDIT".



2 Select "MEMORY DELETE".

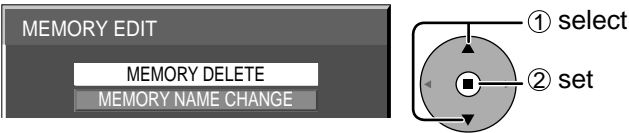

3 Select the profile to delete. To delete all profiles, select "ALL DELETE".



4 Select "OK".

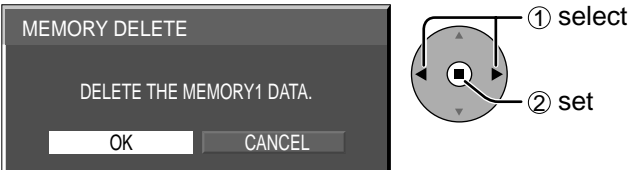

<Renaming profiles>

Note:

Locked profiles cannot be renamed.

1 In the PICTURE menu, select "MEMORY EDIT".



2 Select "MEMORY NAME CHANGE".

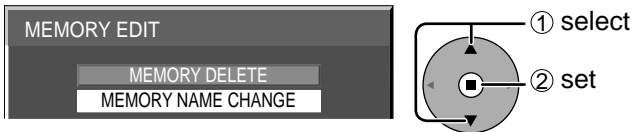

3 Select the profile to rename.



4 Enter a name for the profile. Entering profile names → page 31

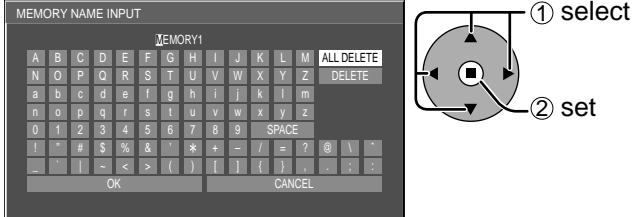

5 When you finished entering the profile name, select "OK". To cancel renaming the profile, select "CANCEL".



Locking profiles

You can lock saved profiles to restrict operations when the profiles are loaded. You can also set passwords.

Notes:

- When the lock is set in “EXTENDED LIFE SETTINGS”, profile cannot be locked.
- If profile is locked, the menu operations of “EXTENDED LIFE SETTINGS” are restricted. (see page 40)

<Locking and unlocking profiles>

1 Display the menu screen. (see page 55)

2 Select “Memory lock”.

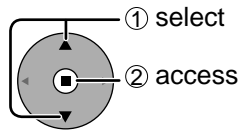
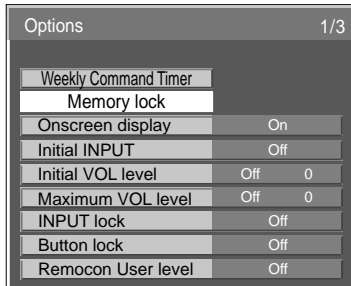

3 Enter a 4-digit password.
The default password is “0123”.



4 Select “Ok”.

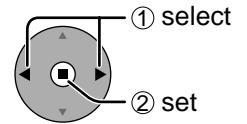
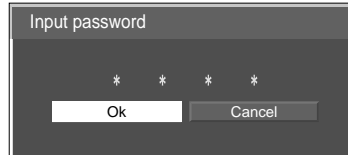

5 Select the profile and specify the desired lock setting.

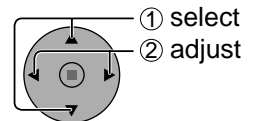
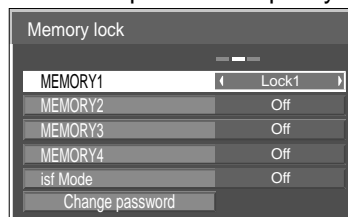

6 Exit the menu.



Once a profile is locked, the following operations are restricted when the profile is loaded.

| Setting | Editing the Profile (MEMORY EDIT) | Editing Picture Adjustment Values via the Menu (PICTURE menu, ADVANCED SETTINGS) | Saving Picture Adjustment Values (MEMORY SAVE) |
|----------------|-----------------------------------|--|--|
| Off (unlocked) | Allowed | Allowed | Allowed |
| Lock1 | Prohibited | Prohibited (picture adjustment values are shown) | Allowed |
| Lock2 | Prohibited | Prohibited (picture adjustment values are hidden) | Prohibited |

Loading locked profiles...

In the PICTURE menu, profiles are labeled with these icons to indicate their locked status.

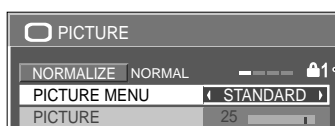

Picture adjustment values in the PICTURE menu cannot be changed, except for the “PICTURE MENU”. Once you edit the “PICTURE MENU” setting, you can edit “PICTURE”, “BRIGHTNESS”, and other picture adjustment values.

🔒1 Lock1

Picture adjustment values are shown.

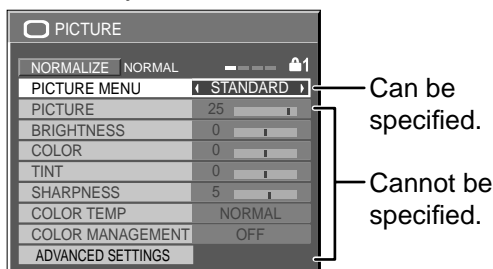

🔒2 Lock2

Picture adjustment values are hidden.

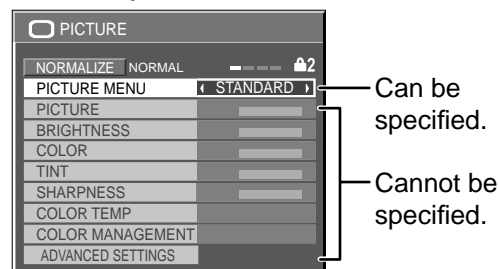

Picture Profiles

<Changing passwords>

1 Follow steps 1–4 in the previous procedure, <Locking and unlocking profiles>.

2 Select “Change password”.

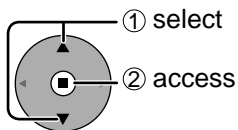
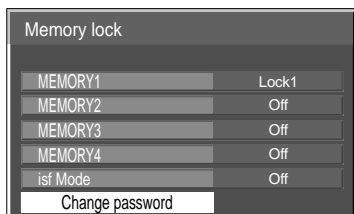

3 Enter a new 4-digit password.



4 Select “Ok”.

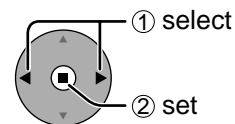
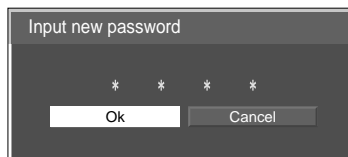

5 Exit the menu.



Note:

Make a note of the new password to remember it.

<isf Mode Setting>

Switches to “PICTURE MENU” mode display.

1 Follow steps 1–4 in the previous procedure, <Locking and unlocking profiles>.

2 Select “isf Mode”.

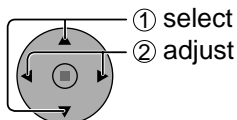
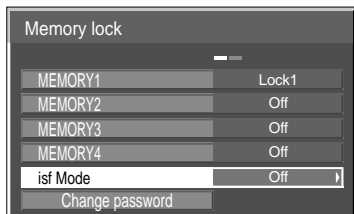

3 Specify “On” or “Off”.

4 Exit the menu.



Specifying “On” for isf Mode changes the “PICTURE MENU” mode display as follows.

“PICTURE MENU” mode display

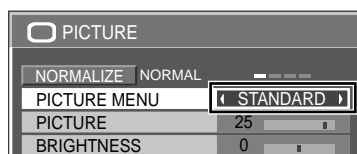

| isf Mode: Off | isf Mode: On |
|---------------|----------------|
| STANDARD | STANDARD |
| DYNAMIC | isf Mode DAY |
| CINEMA | isf Mode NIGHT |
| MONITOR | MONITOR |



SOUND Adjustment

1  Press to display the SOUND menu.

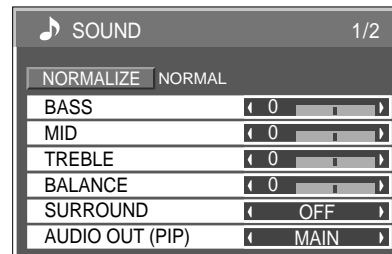
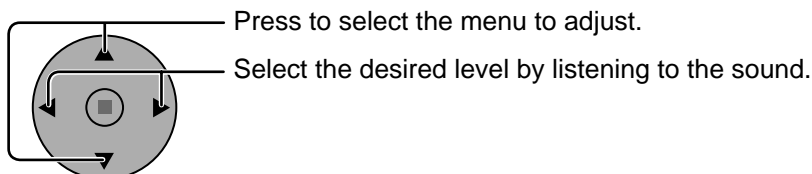
2 Select to adjust each item.

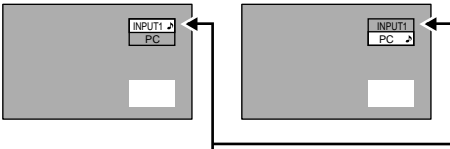

3  Press to exit from adjust mode.

| Item | Details |
|------------------------|---|
| BASS | Adjusts low pitch sounds. |
| MID | Adjusts normal sounds. |
| TREBLE | Adjusts pitch sound. |
| BALANCE | Adjusts left and right volumes. |
| SURROUND | Select ON or OFF. |
| AUDIO OUT (PIP) | <p>MAIN: Selects main picture sound. SUB: Selects PIP frame sound.</p>  <p>Musical note  is displayed on right side of the audio output screen label.</p> |

Helpful Hint (/ **NORMALIZE** Normalization)

While the "SOUND" menu is displayed, if either the N button on the remote control is pressed at any time or the ACTION () button is pressed during "NORMALIZE", then all adjustment values are returned to the factory settings.

SDI SOUND OUTPUT

This menu is displayed when HD-SDI Terminal Board with audio (TY-FB10HD) or Dual Link HD-SDI Terminal Board (TY-FB11DHD) is installed to the unit.

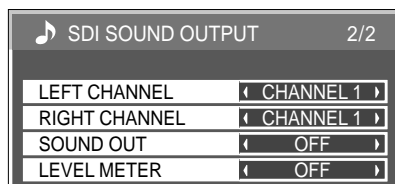

Notes:

- This menu is available only when selecting a slot that HD-SDI Terminal Board with audio (TY-FB10HD) or Dual Link HD-SDI Terminal Board (TY-FB11DHD) is installed.
- This menu is unavailable when 2-picture display mode is active.

| Item | Details |
|----------------------|--|
| LEFT CHANNEL | CHANNEL 1 to CHANNEL 16 Selects left audio channel. |
| RIGHT CHANNEL | CHANNEL 1 to CHANNEL 16 Selects right audio channel. |
| SOUND OUT | ON ↔ OFF ON: Enables audio output. OFF: Disables audio output. |
| LEVEL METER | OFF ↔ 1-8CH ↔ 9-16CH Sets audio channels to show in the audio level meter. 8 channels are displayed in the audio level meter; 4 channels each on both right and left sides of the display. OFF: Hides the audio level meter. 1-8CH: Displays the audio level meter (1-8ch) 9-16CH: Displays the audio level meter (9-16ch) |

PRESENT TIME SETUP / SET UP TIMER

The timer can switch the Plasma Display ON or OFF.

Before attempting Timer Set, confirm the PRESENT TIME OF DAY and adjust if necessary. Then set POWER ON TIME / POWER OFF TIME.

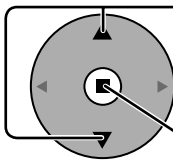
- 1  Press to display the SET UP menu.
- 2  Press to select SET UP TIMER or PRESENT TIME SETUP.
Press to display the SET UP TIMER screen or PRESENT TIME SETUP screen.

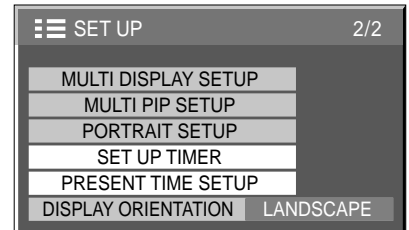

PRESENT TIME SETUP

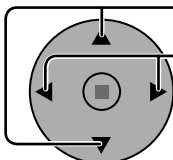
- 1  Press to select DAY or PRESENT TIME OF DAY.
Press to set up DAY or PRESENT TIME OF DAY.
▶ button: Forward
◀ button: Back
Notes:
 - Pressing “◀” or “▶” button once changes PRESENT TIME OF DAY 1 minute.
 - Pressing “◀” or “▶” button continuously changes PRESENT TIME OF DAY by 15 minutes.

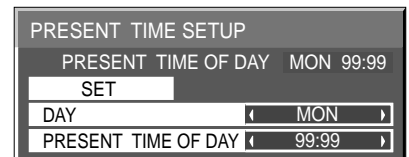

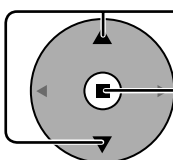
- 2  Press to select SET.
Press to store PRESENT TIME SETUP.
Notes:
 - SET cannot be selected unless PRESENT TIME OF DAY is set.
 - Unless setting the present time other than “99:99”, DAY setting is invalid.
 - The settings of “DAY” and “PRESENT TIME OF DAY” are reset when leaving the display turned off for about 7 days for the following reasons:
Pressing ⏻/| switch of the unit to turn off the display.
Disconnecting the AC cord.
Interruption of power supply.

SET UP TIMER

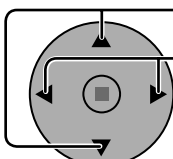
- 1  Press to select POWER ON TIME / POWER OFF TIME.
Press to set up POWER ON TIME / POWER OFF TIME.
▶ button: Forward
◀ button: Back
Notes:
 - Pressing “◀” or “▶” button once changes POWER ON TIME / POWER OFF TIME 1 minute.
 - Pressing “◀” or “▶” button continuously changes POWER ON TIME / POWER OFF TIME by 15 minutes.

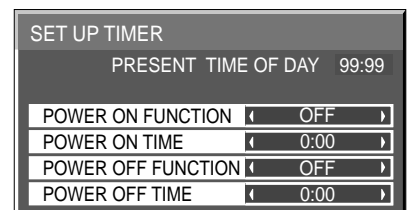

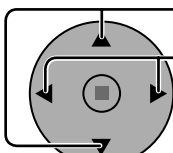
- 2  Press to select POWER ON FUNCTION / POWER OFF FUNCTION.
Press to select ON.
Note:
Timer function will not work unless “PRESENT TIME OF DAY” is set.

SCREENSAVER (For preventing image retention)

Do not display a still picture, especially in 4:3 mode, for any length of time.
If the display must remain on, a SCREENSAVER should be used.

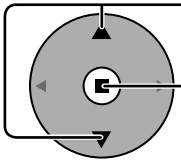
- 1  Press to display the SET UP menu.
- 2  Press to select the SCREENSAVER.
Press to select the SCREENSAVER screen.

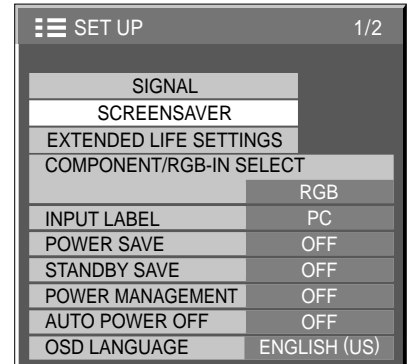

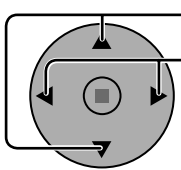
- 3 **FUNCTION selection**
 Press to select the FUNCTION.
Press to select the desired function.
 - NEGATIVE IMAGE ↔ SCROLLING BAR ONLY ←
 - WHITE SCREEN ↔ OVERLAY SCROLLING BAR ←

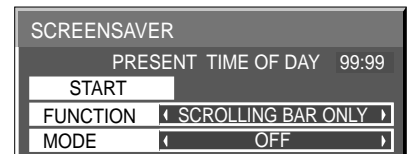

NEGATIVE IMAGE : A negative image will be displayed on the screen.
 SCROLLING BAR ONLY : A white bar will scroll from left to right. The image won't be displayed.
 OVERLAY SCROLLING BAR : The brightness of the image will be decreased and a white bar will scroll on it.
 WHITE SCREEN : The whole screen will be white.

Note: OVERLAY SCROLLING BAR is not effective during two screen display.

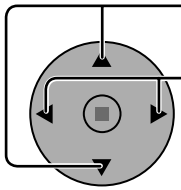
- 4 **MODE selection**
 Press to select the MODE.
Press to select each mode items.

- Off
- ↕
- INTERVAL : Operates when SHOW DURATION and SAVER DURATION are set up and those times arrive.
- ↕
- TIME OF DAY : Operates when START TIME and FINISH TIME are set up and those times arrive.
- ↕
- STANDBY AFTER SCR SAVER: Operates while SCREENSAVER DURATION, and display enters standby mode.
- ↕
- ON : Operates when START is selected and the ACTION (■) button is pressed.

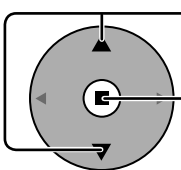
- 5 **START setting**
 When the MODE is set to ON, press to select START.
Press to start SCREENSAVER.

The menu screen will disappear and the SCREENSAVER will be activated. **To stop the SCREENSAVER under ON, press the R button or any buttons on the main unit.**
Note: When the display is turned off, the SCREENSAVER will be deactivated.

Setup of SCREENSAVER Time

After selecting TIME OF DAY, INTERVAL or STANDBY AFTER SCR SAVER, the relevant Time Setup will become available for selection and the Operating Time may be set. (Time cannot be set when "MODE" is "ON" or "OFF".)

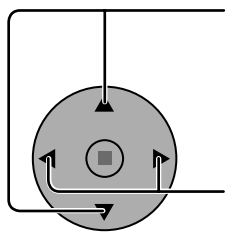

Press to select START TIME / FINISH TIME (when TIME OF DAY is selected).

Press to select SHOW DURATION / SAVER DURATION (when INTERVAL is selected).

Press to select SCREENSAVER DURATION (when STANDBY AFTER SCR SAVER is selected).

Press to setup.

▶ button: Forward

◀ button: Back

Notes:

- Pressing "◀" or "▶" button once changes the Time 1 minute. [However, switching occurs every 15 minutes when Periodic Time is selected.]
- Pressing "◀" or "▶" button continuously changes the Time by 15 minutes.
- "SCREENSAVER DURATION" of the "STANDBY AFTER SCR SAVER" can be set from 0:00 to 23:59. When this is set to "0:00", "STANDBY AFTER SCR SAVER" will not be activated.

Note: Timer function will not work unless "PRESENT TIME OF DAY" is set.

| SCREENSAVER | |
|---------------------|--------------------|
| PRESENT TIME OF DAY | 15:00 |
| START | |
| FUNCTION | SCROLLING BAR ONLY |
| MODE | TIME OF DAY |
| START TIME | ◀ 6:15 ▶ |
| FINISH TIME | ◀ 12:30 ▶ |

| SCREENSAVER | |
|---------------------|--------------------|
| PRESENT TIME OF DAY | 15:00 |
| START | |
| FUNCTION | SCROLLING BAR ONLY |
| MODE | INTERVAL |
| SHOW DURATION | ◀ 12:00 ▶ |
| SAVER DURATION | ◀ 3:00 ▶ |

| SCREENSAVER | |
|----------------------|-------------------------|
| PRESENT TIME OF DAY | 15:00 |
| START | |
| FUNCTION | SCROLLING BAR ONLY |
| MODE | STANDBY AFTER SCR SAVER |
| SCREENSAVER DURATION | ◀ 6:15 ▶ |

Reduces screen image retention

EXTENDED LIFE SETTINGS

The following settings are setup to reduce image retention:

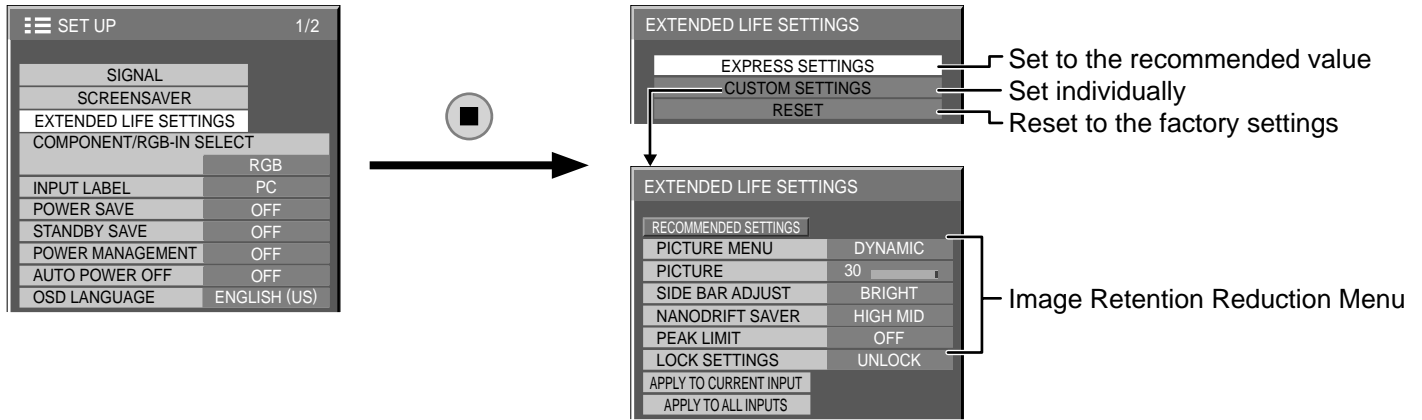

Image Retention Reduction Menu

“EXTENDED LIFE SETTINGS” enables you to set the following 5 menus (Image Retention Reduction Menu) as recommended values or set them individually.

PICTURE MENU

PICTURE

“PICTURE MENU” and “PICTURE” are same as “PICTURE” menu items (see page 28). The settings of this menu will be reflected to the “PICTURE” menu.

SIDE BAR ADJUST

Do not display a picture in 4:3 mode for an extended period, as this can cause an image retention to remain on the side bars on either side of the display field.

To reduce the risk of such an image retention, illuminate the side bars.

This function may be applicable to the non-picture area.

- OFF:** Darken both ends.
- DARK:** Make it dark gray.
- MID:** Make it gray.
- BRIGHT:** Make it light gray.

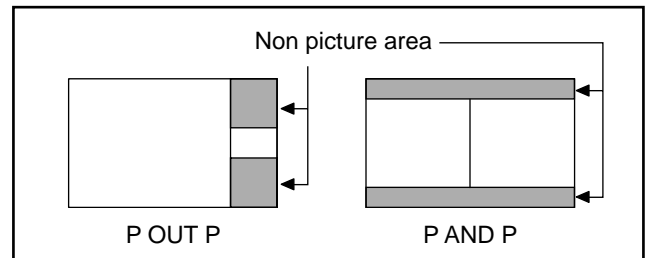
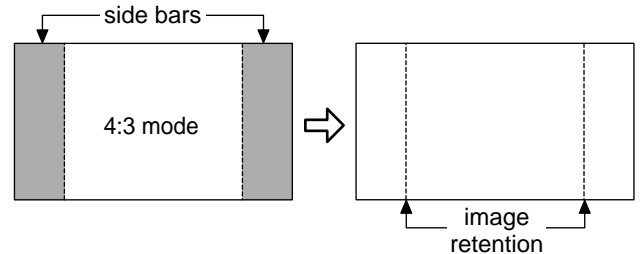

Notes:

- To reduce the occurrence of image retention, set the SIDE BAR ADJUST to BRIGHT.
- The side bar may flash (alternate black/white) depending on the picture being shown on the screen. Using Cinema mode will reduce such flashing.

Reduces screen image retention

NANODRIFT SAVER

Moves the display position of the screen slightly to reduce image retention on the display panel.

OFF: NANODRIFT SAVER does not operate.

MIN-MAX: NANODRIFT SAVER operates. The display position of the screen moves at set time intervals. You can set the screen movement range. Some of the screen may appear to be missing as a result of this operation. If you change the value, a mask is displayed in the range where the picture is missing as a result of position movement.



If this is set to other than "OFF", "NANODRIFT" is displayed below the aspect mode display.

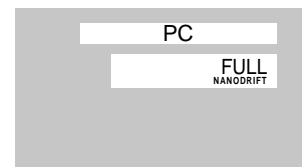

Note:

This function does not work in the following cases.

When "MULTI DISPLAY SETUP" is set to "ON"

When "PORTRAIT SETUP" is set to "ON"

When in digital zoom mode

PEAK LIMIT

ON: Suppresses image contrast (peak brightness).

Note: When a still picture is viewed for an extended time, the screen may become slightly darker. (see page 60)

EXTENDED LIFE SETTINGS when profile is locked

If profile is locked with "Memory lock" of the Options menu, the operations of this settings menu are restricted as shown below. "Locking profiles" → page 33

EXPRESS SETTINGS: Cannot be set.

CUSTOM SETTINGS: "PICTURE MENU", "PICTURE" and "LOCK SETTINGS" cannot be set.

RESET: "PICTURE MENU" and "PICTURE" are not reset.

EXPRESS SETTINGS

Set the "Image Retention Reduction" menu to the recommended settings.

All menus will be locked.

PICTURE MENU: STANDARD

PICTURE: 10

SIDE BAR ADJUST: BRIGHT

NANODRIFT SAVER: HIGH MID

PEAK LIMIT: ON

1 Select "EXPRESS SETTINGS".

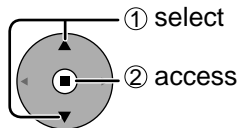
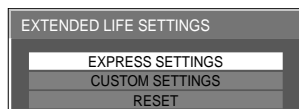

3 Select "YES".

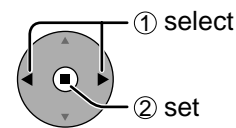
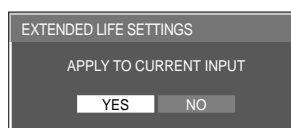

2 Select the input to apply the settings.

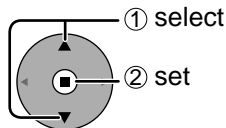
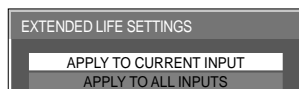

CUSTOM SETTINGS

Set the individual "Image Retention Reduction" menu.

- 1** Select "CUSTOM SETTINGS".

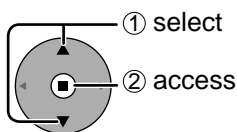
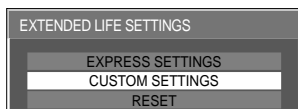

- 2** To set each menu to the recommended setting:
Select "RECOMMENDED SETTINGS".

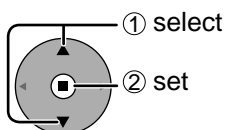
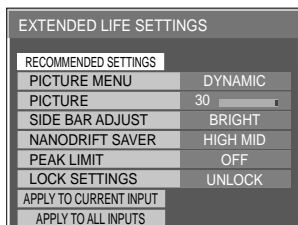

Each menu will be set as same as the "EXPRESS SETTINGS".

- 3** Set each menu.

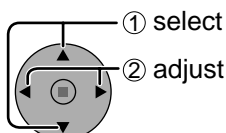
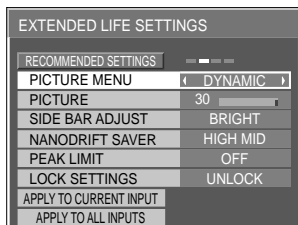

- 4** To lock each menu setting:
Set the "LOCK SETTINGS" to "LOCK".

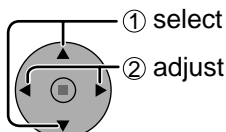
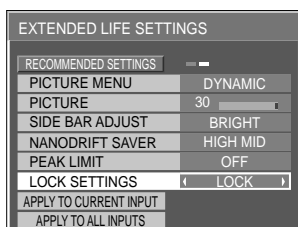

When a menu is locked, it is grayed out and cannot be set. "PICTURE MENU" and "PICTURE" will no longer be able to set in the "PICTURE" menu, and they are labeled with icon to indicate their locked status. Also, "NORMALIZE", "MEMORY SAVE" and "MEMORY LOAD" are not available.

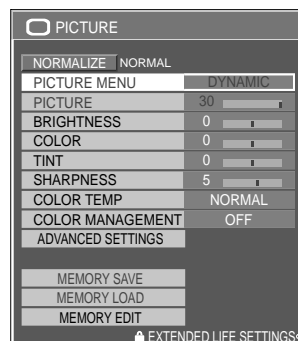

- 5** Select the input to apply the settings.

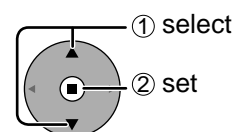
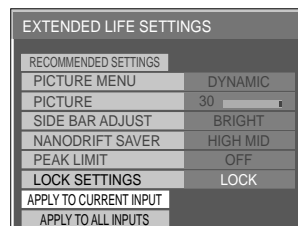

- 6** Select "YES".

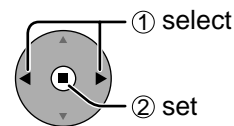
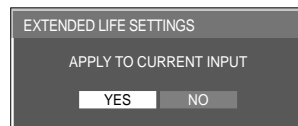

RESET

Reset the "Image Retention Reduction" menu to the factory settings. Each menu will be unlocked.

- 1** Select "RESET".

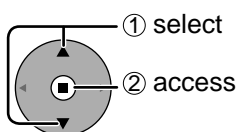
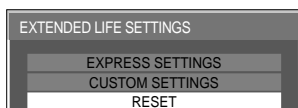

- 3** Select "YES".

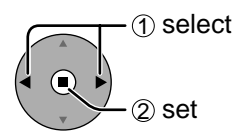
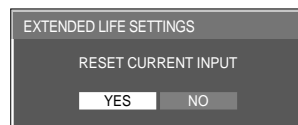

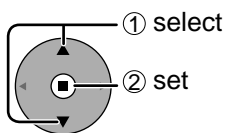
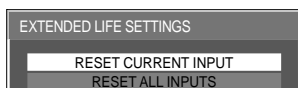

- 2** Select the input to reset the settings.

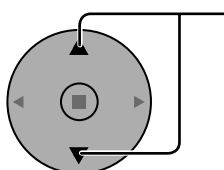
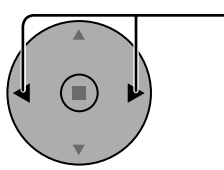

Reduces power consumption

- **POWER SAVE:** When this function is turned ON, luminous level of the Plasma Display is suppressed, so power consumption is reduced.
 - **STANDBY SAVE:** When this function is turned ON, power consumption of the microcomputer is reduced during power supply standby (see page 13, 16, 17), so standby power of the set is reduced.
 - **POWER MANAGEMENT:** When this function is set to ON, it operates under the following conditions to turn the power on or off automatically.
 When no pictures (HD/VD sync signals) are detected for 30 or so seconds during PC signal input:
 → Power is turned off (standby); the power indicator lights up orange.
 When pictures (HD/VD sync signals) are subsequently detected:
 → Power is turned on; the power indicator lights up green.
- Notes:**
- This function operates only during PC signal input.
 - This function is invalid during input from PC Input Terminal Board (TY-42TM6P).
 - This function is effective when “SYNC” is set to “AUTO”, “COMPONENT / RGB-IN SELECT” is set to “RGB” and during normal viewing (one picture screen).
- **AUTO POWER OFF:** Equipment power supply is turned OFF when there is no signal.
 When this is set to “ON”, the power supply of the unit goes Off 10 minutes after the input signals stop.
- Note:**
 This function is effective during normal viewing (one picture screen) for input signals except PC IN terminal.

- 1**  Press to select “POWER SAVE”
“STANDBY SAVE”
“POWER MANAGEMENT”
“AUTO POWER OFF”.
- 2**  Press to select “ON” or “OFF”.
On ← → Off
- 3**  SET UP
Press to exit from SET UP.

| SET UP | | 1/2 |
|-------------------------|---|--------------|
| SIGNAL | | |
| SCREENSAVER | | |
| EXTENDED LIFE SETTINGS | | |
| COMPONENT/RGB-IN SELECT | | |
| | | RGB |
| INPUT LABEL | | PC |
| POWER SAVE | ← | OFF → |
| STANDBY SAVE | ← | OFF → |
| POWER MANAGEMENT | ← | OFF → |
| AUTO POWER OFF | ← | OFF → |
| OSD LANGUAGE | | ENGLISH (US) |

Customizing the Input labels

This function can change the label of the Input signal to be displayed.

Select the input signal which you would like to change its label before customizing the Input labels. (see page 15, 17)

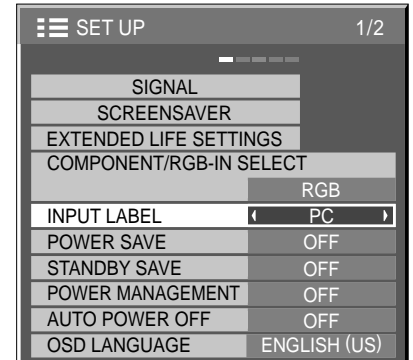
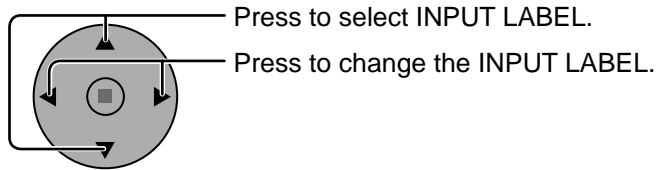

Note:

While selecting a Input signal through Optional Terminal Board connected to Slot 1, Slot 2 and Slot 3, the Input label will depend on each Optional Terminal Board.

INPUT LABELS for SLOT 1, 2, 3 and PC IN:

[SLOT1] INPUT1 / DVD1 / DVD2 / DVD3 / Blu-ray1 / Blu-ray2 / Blu-ray3 / CATV / VCR / STB

[SLOT2] INPUT2 / DVD1 / DVD2 / DVD3 / Blu-ray1 / Blu-ray2 / Blu-ray3 / CATV / VCR / STB

[SLOT3] INPUT3 / DVD1 / DVD2 / DVD3 / Blu-ray1 / Blu-ray2 / Blu-ray3 / CATV / VCR / STB

[PC IN] PC / DVD1 / DVD2 / DVD3 / Blu-ray1 / Blu-ray2 / Blu-ray3 / CATV / VCR / STB

When BNC Dual Video Terminal Board (TY-FB9BD) is used, an "A" or "B" is added at the end of each input label, depending on the input selected (see below).

| Addition sign | "A" | "B" |
|----------------|-----------|---------|
| Selected Input | Composite | S VIDEO |

Selecting the On-Screen Menu Language

1 Press to display the SET UP menu.

2 Press to select OSD LANGUAGE.
 Press to select your preferred language.

■ Selectable languages

- English(UK)
- Deutsch
- Français
- Italiano
- Español
- ENGLISH(US)
- 中文.....(Chinese)
- 日本語.....(Japanese)
- Русский.....(Russian)

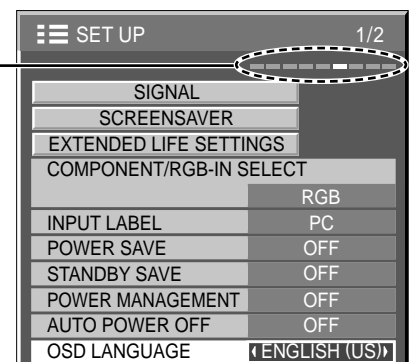

DISPLAY ORIENTATION

Sets the fan control and the display style of on-screen menu for vertical installation.

1  Press to display the SET UP menu.

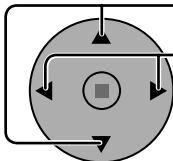
2  Press to select DISPLAY ORIENTATION.
Press to select "LANDSCAPE" or "PORTRAIT".

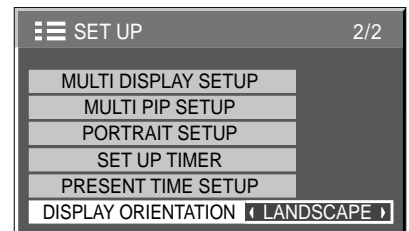

3  Press to exit from adjust mode



LANDSCAPE

Fan control for horizontal installation.



PORTRAIT

Fan control for vertical installation. On-screen menu will be rotated 90 degrees counterclockwise to be suitable for the setting.

Notes:

- If the display is installed vertically, the power switch should be located at the bottom.
- Fan control will be switched when turning on the unit next time.

SET UP for MULTI DISPLAY

By lining up Plasma Displays in groups, for example, as illustrated below, an enlarged picture may be displayed across all screens. For this mode of operation, each plasma display has to be set up with a Display number to determine its location.

(Example)

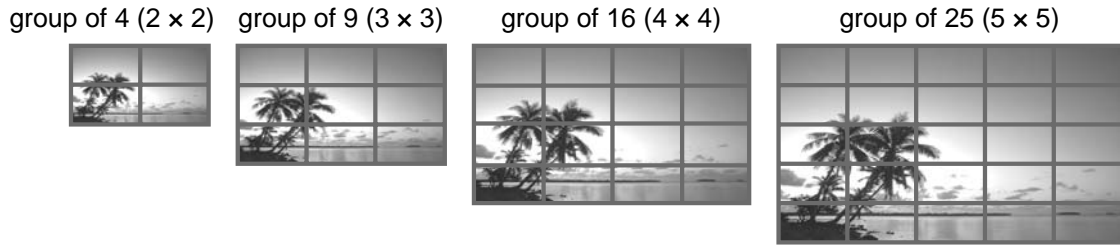

How to setup MULTI DISPLAY

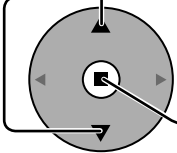
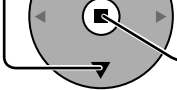
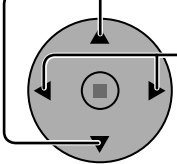
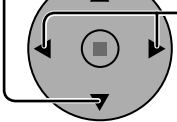
- 1  Press to display the SET UP menu.
- 2  Press to select the MULTI DISPLAY SETUP.
 Press to display the "MULTI DISPLAY SETUP" menu.
- 3  Press to select the MULTI DISPLAY SETUP.
 Press to select "ON" or "OFF".

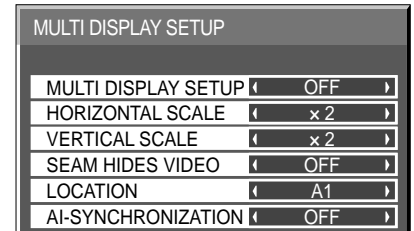
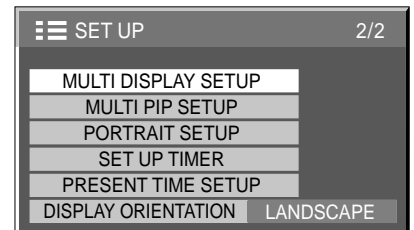

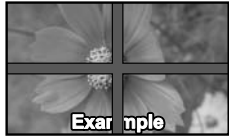
| Item | Details | | | | | | | | | | | | | | | | | | | | | | | | | | | | | | | | | | | | | | | | | | | | | | | | | | | | | | | | | |
|----------------------------|---|----|----|----|----|----|----|----|----|----|----|----|----|----|----|----|----|----|----|----|----|----|----|----|----|----|----|----|----|----|----|----|----|----|----|----|----|----|----|----|----|----|----|----|----|----|----|----|----|----|----|----|----|----|----|----|----|----|
| MULTI DISPLAY SETUP | Select "ON" or "OFF". Note: If you set MULTI DISPLAY SETUP to ON, PORTRAIT SETUP will be unavailable. | | | | | | | | | | | | | | | | | | | | | | | | | | | | | | | | | | | | | | | | | | | | | | | | | | | | | | | | | |
| HORIZONTAL SCALE | Select "x 1", "x 2", "x 3", "x 4", "x 5". | | | | | | | | | | | | | | | | | | | | | | | | | | | | | | | | | | | | | | | | | | | | | | | | | | | | | | | | | |
| VERTICAL SCALE | Select "x 1", "x 2", "x 3", "x 4", "x 5". | | | | | | | | | | | | | | | | | | | | | | | | | | | | | | | | | | | | | | | | | | | | | | | | | | | | | | | | | |
| SEAM HIDES VIDEO | Select "ON" or "OFF". <div style="display: flex; justify-content: space-around; align-items: center;"> <div style="text-align: center;"> <p>To hide joints between displays.</p>  <p>Example</p> <p>Suitable for moving image display.</p> <p>ON</p> </div> <div style="text-align: center;"> <p>To show joints between displays.</p>  <p>Example</p> <p>Suitable for still image display.</p> <p>OFF</p> </div> </div> | | | | | | | | | | | | | | | | | | | | | | | | | | | | | | | | | | | | | | | | | | | | | | | | | | | | | | | | | |
| LOCATION | Select the required arrangement number. (A1-E5 : Refer to the following) Display Number locations for each arrangement. (Examples) <div style="display: flex; justify-content: space-around; align-items: flex-start;"> <div style="text-align: center;"> <p>(2 x 1)</p> <table border="1" style="border-collapse: collapse;"> <tr><td>A1</td><td>A2</td></tr> </table> </div> <div style="text-align: center;"> <p>(2 x 3)</p> <table border="1" style="border-collapse: collapse;"> <tr><td>A1</td><td>A2</td></tr> <tr><td>B1</td><td>B2</td></tr> <tr><td>C1</td><td>C2</td></tr> </table> </div> <div style="text-align: center;"> <p>(4 x 2)</p> <table border="1" style="border-collapse: collapse;"> <tr><td>A1</td><td>A2</td><td>A3</td><td>A4</td></tr> <tr><td>B1</td><td>B2</td><td>B3</td><td>B4</td></tr> </table> </div> <div style="text-align: center;"> <p>(4 x 4)</p> <table border="1" style="border-collapse: collapse;"> <tr><td>A1</td><td>A2</td><td>A3</td><td>A4</td></tr> <tr><td>B1</td><td>B2</td><td>B3</td><td>B4</td></tr> <tr><td>C1</td><td>C2</td><td>C3</td><td>C4</td></tr> <tr><td>D1</td><td>D2</td><td>D3</td><td>D4</td></tr> </table> </div> <div style="text-align: center;"> <p>(5 x 5)</p> <table border="1" style="border-collapse: collapse;"> <tr><td>A1</td><td>A2</td><td>A3</td><td>A4</td><td>A5</td></tr> <tr><td>B1</td><td>B2</td><td>B3</td><td>B4</td><td>B5</td></tr> <tr><td>C1</td><td>C2</td><td>C3</td><td>C4</td><td>C5</td></tr> <tr><td>D1</td><td>D2</td><td>D3</td><td>D4</td><td>D5</td></tr> <tr><td>E1</td><td>E2</td><td>E3</td><td>E4</td><td>E5</td></tr> </table> </div> </div> | A1 | A2 | A1 | A2 | B1 | B2 | C1 | C2 | A1 | A2 | A3 | A4 | B1 | B2 | B3 | B4 | A1 | A2 | A3 | A4 | B1 | B2 | B3 | B4 | C1 | C2 | C3 | C4 | D1 | D2 | D3 | D4 | A1 | A2 | A3 | A4 | A5 | B1 | B2 | B3 | B4 | B5 | C1 | C2 | C3 | C4 | C5 | D1 | D2 | D3 | D4 | D5 | E1 | E2 | E3 | E4 | E5 |
| A1 | A2 | | | | | | | | | | | | | | | | | | | | | | | | | | | | | | | | | | | | | | | | | | | | | | | | | | | | | | | | | |
| A1 | A2 | | | | | | | | | | | | | | | | | | | | | | | | | | | | | | | | | | | | | | | | | | | | | | | | | | | | | | | | | |
| B1 | B2 | | | | | | | | | | | | | | | | | | | | | | | | | | | | | | | | | | | | | | | | | | | | | | | | | | | | | | | | | |
| C1 | C2 | | | | | | | | | | | | | | | | | | | | | | | | | | | | | | | | | | | | | | | | | | | | | | | | | | | | | | | | | |
| A1 | A2 | A3 | A4 | | | | | | | | | | | | | | | | | | | | | | | | | | | | | | | | | | | | | | | | | | | | | | | | | | | | | | | |
| B1 | B2 | B3 | B4 | | | | | | | | | | | | | | | | | | | | | | | | | | | | | | | | | | | | | | | | | | | | | | | | | | | | | | | |
| A1 | A2 | A3 | A4 | | | | | | | | | | | | | | | | | | | | | | | | | | | | | | | | | | | | | | | | | | | | | | | | | | | | | | | |
| B1 | B2 | B3 | B4 | | | | | | | | | | | | | | | | | | | | | | | | | | | | | | | | | | | | | | | | | | | | | | | | | | | | | | | |
| C1 | C2 | C3 | C4 | | | | | | | | | | | | | | | | | | | | | | | | | | | | | | | | | | | | | | | | | | | | | | | | | | | | | | | |
| D1 | D2 | D3 | D4 | | | | | | | | | | | | | | | | | | | | | | | | | | | | | | | | | | | | | | | | | | | | | | | | | | | | | | | |
| A1 | A2 | A3 | A4 | A5 | | | | | | | | | | | | | | | | | | | | | | | | | | | | | | | | | | | | | | | | | | | | | | | | | | | | | | |
| B1 | B2 | B3 | B4 | B5 | | | | | | | | | | | | | | | | | | | | | | | | | | | | | | | | | | | | | | | | | | | | | | | | | | | | | | |
| C1 | C2 | C3 | C4 | C5 | | | | | | | | | | | | | | | | | | | | | | | | | | | | | | | | | | | | | | | | | | | | | | | | | | | | | | |
| D1 | D2 | D3 | D4 | D5 | | | | | | | | | | | | | | | | | | | | | | | | | | | | | | | | | | | | | | | | | | | | | | | | | | | | | | |
| E1 | E2 | E3 | E4 | E5 | | | | | | | | | | | | | | | | | | | | | | | | | | | | | | | | | | | | | | | | | | | | | | | | | | | | | | |



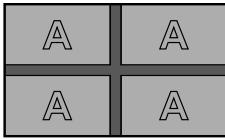





SET UP for MULTI DISPLAY

| Item | Details |
|--------------------------|--|
| AI-SYNCRONIZATION | <p>Select "OFF" or "ON".</p> <p>The brightness depends on each display's setting.</p>  <p>OFF</p> <p>Equalize the brightness of all the displays.</p>  <p>ON</p> <p>Note: If you set AI-SYNCRONIZATION to ON, the following menus will be unavailable and these settings will be fixed to the initial values. PICTURE menu: COLOR, TINT, INPUT LEVEL (ADVANCED SETTINGS)</p> |

- 4** **SET UP**  Press to exit from adjust mode.

ID Remote Control Function

You can set the remote control ID when you want to use this remote control on one of several different displays.

- Switch  to  on the right side.
- Press the  button on the remote control.
- Press one of , ,  for the tens digit setting.
- Press one of , ,  for the units digit setting.

Notes:

- The numbers in 2, 3 and 4 should be set up quickly.
- Adjustable ID number range is 0 - 99.
- If a number button is pressed more than two times, the first two numbers become the ID number for the remote control.

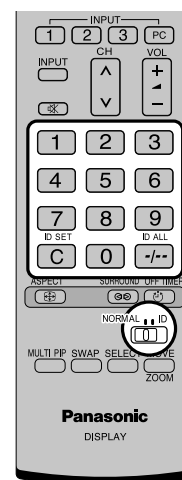

ID remote control button operation

The operation is the same as normal remote control except for the  button.

ID Cancellation



Press  button on remote control. (This has the same effect as pressing the , ,  buttons at the same time.)

Notes:

- Set the Remote ID "On" to operate the ID remote control.
If remote ID is set to "On", you can use the remote control without identical ID number during option menu display. (see page 56)
- The ID remote control cannot be used when ID select is set to anything other than 0, and the remote control ID is not the same as the ID select number (see page 56).

MULTI PIP SETUP

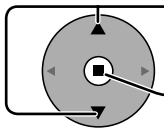
Set the two-screen display function that is activated when  is pressed.

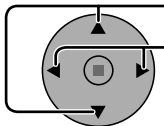
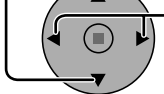
- 1  Press to display the SET UP menu.
- 2  Press to select the MULTI PIP SETUP.
 Press to display the "MULTI PIP SETUP" menu.
- 3  Press to select the menu to adjust.
 Press to adjust the menu.

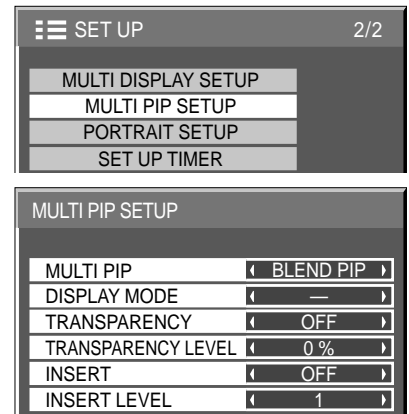

MULTI PIP

Set the two-screen function.



DISPLAY MODE

The display mode can be changed separately for each function that was set in "MULTI PIP SETUP".

For "PIP":

For "ADVANCED PIP":

For "BLEND PIP":

Note: The display mode changes in the same way when  is pressed.

Transparent Display of the Sub Screen (During BLEND PIP)

- ① Select "ON" in "TRANSPARENCY".
- ② Set the transparency level for the sub screen in "TRANSPARENCY LEVEL". (0 to 100 %)
 - Setting example Transparent image (sub screen)



Note: "INSERT" cannot be set when "TRANSPARENCY" is "ON".

Sub Screen Insertion (During BLEND PIP)

- ① Select "ON" in "INSERT".
- ② Set the "INSERT LEVEL". (1 to 10 %)
 - Set the brightness level threshold for discriminating between the transparent areas and non-transparent areas on the sub screen.
 - Setting example Image to insert (sub screen)

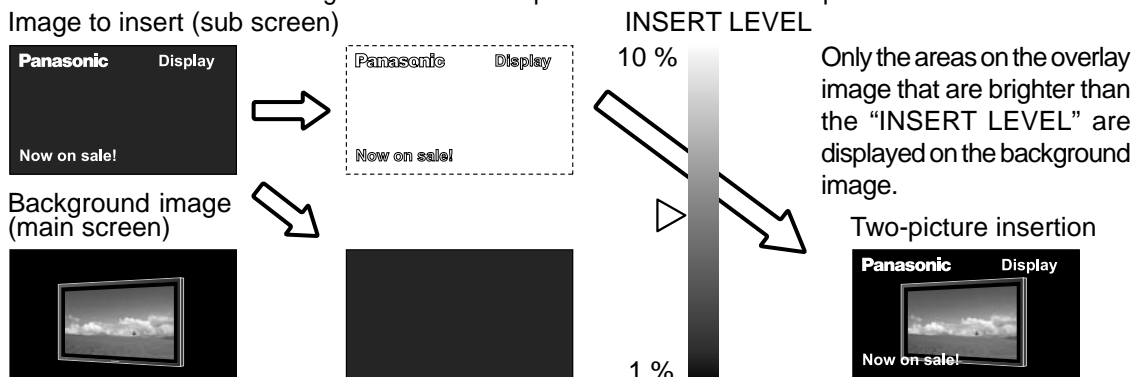

Note: "TRANSPARENCY" cannot be set when "INSERT" is "ON".

SET UP for PORTRAIT

Divide an input image into 3 parts, and display one of them to a plasma display which is set vertically. The image will be enlarged 3 times and rotated 90-degree.

(Example)





Note:

When using the PORTRAIT function with displays set vertically, "DISPLAY ORIENTATION" in SET UP menu has to be set to "PORTRAIT" (see page 44).

How to setup PORTRAIT

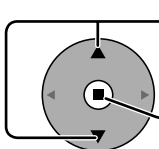
1  Press to display the SET UP menu.

2  Press to select the PORTRAIT SETUP.
 Press to display the "PORTRAIT SETUP" menu.

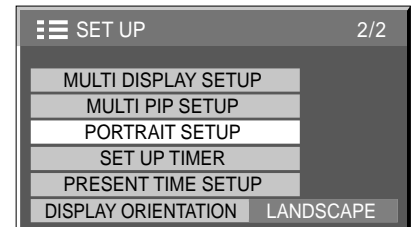

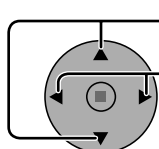
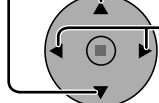

3  Press to select the PORTRAIT SETUP.
 Press to select "ON" or "OFF".

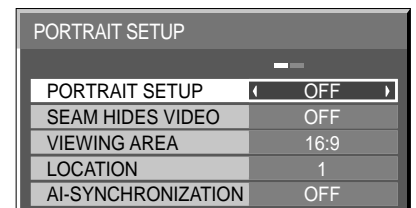
Note:
 If you set PORTRAIT SETUP to ON, MULTI DISPLAY SETUP will be unavailable.

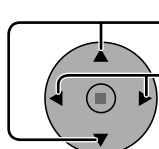
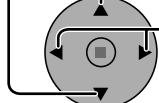

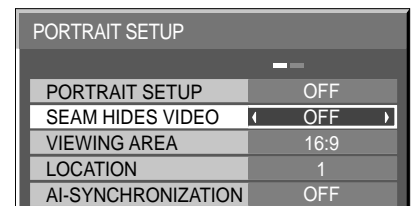
4  Press to select SEAM HIDES VIDEO.
 Press to select "OFF", "ON".



| | |
|--|--|
| <p>To hide joints between displays.</p>  <p>Example</p> <p>Suitable for moving image display.</p> <p style="text-align: center;">ON</p> | <p>To show joints between displays.</p>  <p>Example</p> <p>Suitable for still image display.</p> <p style="text-align: center;">OFF</p> |
|--|--|

5 VIEWING AREA / LOCATION

VIEWING AREA: Set a mode of image division for PORTRAIT function.

LOCATION: Set a location of image to be displayed for PORTRAIT function.

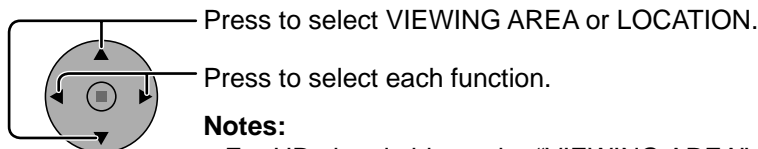

Notes:

- For HD signal videos, the "VIEWING AREA" is set at "16:9", and cannot be changed.
HD signal: 1125 (1080) / 60i • 50i • 60p • 50p • 24p • 25p • 30p • 24sF, 750 (720) / 60p • 50p, 1250 (1080) / 50i
- When "VIEWING AREA" is "16:9", the aspect mode is set to "FULL".

| PORTRAIT SETUP | |
|--------------------|------|
| PORTRAIT SETUP | OFF |
| SEAM HIDES VIDEO | OFF |
| VIEWING AREA | 16:9 |
| LOCATION | 1 |
| AI-SYNCHRONIZATION | OFF |

LOCATION setting

When PORTRAIT SETUP "ON":

Display the image of the selected LOCATION.

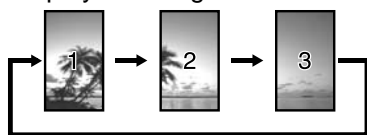

When PORTRAIT SETUP is "OFF":

Represent an area of the selected LOCATION at a normal brightness and darken the rest of it.



VIEWING AREA and LOCATION

The mode of image division and the LOCATION by setting of VIEWING AREA is as follows.

VIEWING AREA: 16:9

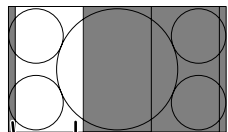

LOCATION 1

Undisplayed area (48 dots)

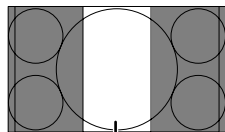

LOCATION 2

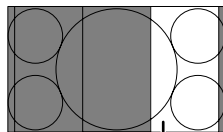

LOCATION 3

Suitable to display FULL images. NORMAL (4:3) images extend transversely. Both right and left sides of the image are cut by 48 dots.

VIEWING AREA: 4:3

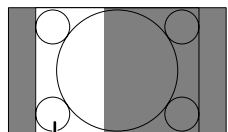

LOCATION 1

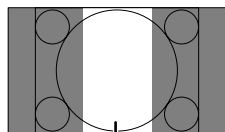

LOCATION 2

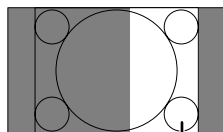

LOCATION 3

4:3 images are displayed without changing aspect ratio. Although the images of each LOCATION overlap, you can adjust POS. / SIZE to display the image normally. (see page 25)

6 AI-SYNCHRONIZATION

Adjust to equalize the brightness of the 3 displays when using PORTRAIT setting.

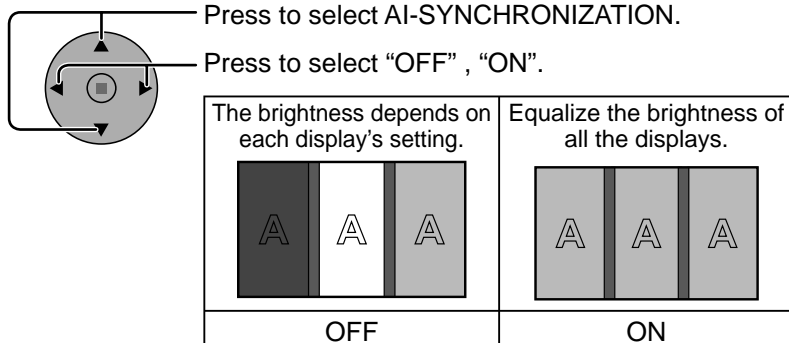

| PORTRAIT SETUP | |
|--------------------|------|
| PORTRAIT SETUP | OFF |
| SEAM HIDES VIDEO | OFF |
| VIEWING AREA | 16:9 |
| LOCATION | 1 |
| AI-SYNCHRONIZATION | OFF |

Note:

If you set AI-SYNCHRONIZATION to ON, the following menu will be unavailable and these settings will be fixed to the initial values.
PICTURE menu: COLOR, TINT, INPUT LEVEL (ADVANCED SETTINGS)

7

SET UP



Press to exit from adjust mode.

SET UP for Input Signals

COMPONENT / RGB IN SELECT

Select to match the signals from the source connected to the COMPONENT / RGB input terminals.

Y, P_B, P_R signals ⇒ "COMPONENT"

RGB signals ⇒ "RGB"

1  Press to display the SET UP menu.

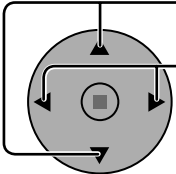
2  Press to select the "COMPONENT / RGB-IN SELECT".
Press to select the desired mode.
COMPONENT ← → RGB

3  Press to exit from adjust mode.

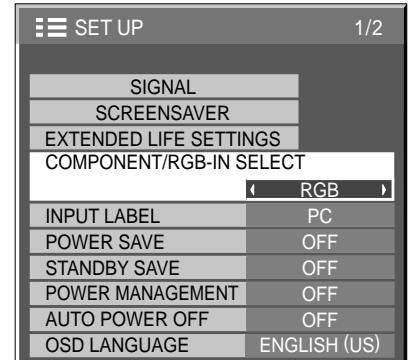

Notes:

- Selection may not be possible, depending on which optional board is installed.
- Make setting of the selected input terminal (SLOT1, SLOT2, SLOT3 or PC IN).

YUV / RGB IN SELECT

Select to match the signals from the source connected to the DVI input terminals.

YUV signals ⇒ "YUV"

RGB signals ⇒ "RGB"

1  Press to display the SET UP menu.

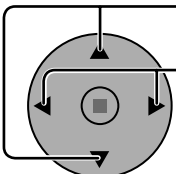
2  Press to select the "YUV / RGB-IN SELECT".
Press to select the desired mode.
YUV ← → RGB

3  Press to exit from adjust mode.

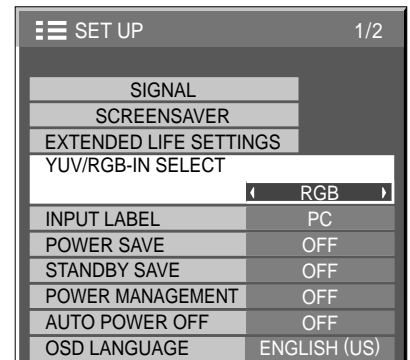



Notes:

- Selection may not be possible, depending on which optional board is installed.
- Make setting of the selected input terminal (SLOT1 or SLOT2).

SIGNAL menu

Note:

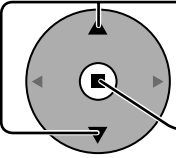
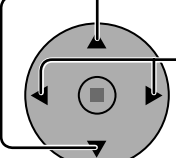
“SIGNAL” setup menu displays a different setting condition for each input signal.

- 1  Press to display the SET UP menu.
- 2  Press to select the “SIGNAL”.
Press to display the SIGNAL menu.
- 3  Press to select the menu to adjust.
Press to adjust the menu.
- 4  Press to exit from adjust mode.

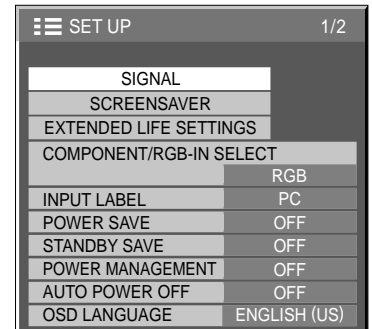

↓ Press ACTION (■) button

For VIDEO (S VIDEO)

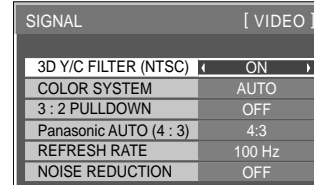

For RGB

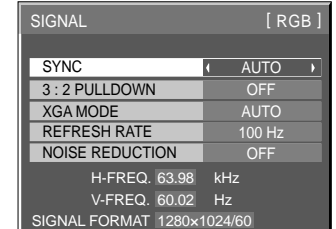

For COMPONENT

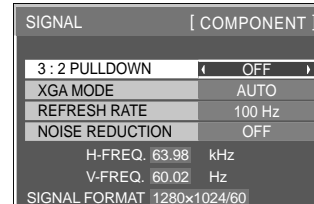

For Digital

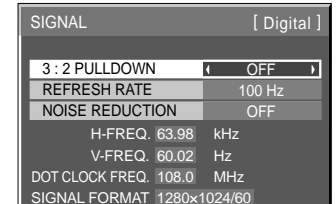

3D Y/C FILTER – For NTSC AV images

Select “SIGNAL” from the “SET UP” menu during VIDEO (S VIDEO) input signal mode. (“SIGNAL [VIDEO]” menu is displayed.)

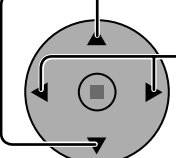
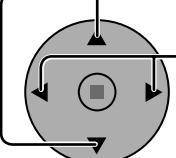
- 1  Press to select the “3D Y/C FILTER (NTSC)”.
- 2  Press to set ON / OFF.



Note:

When ON, this setting only affects NTSC input signals.

COLOR SYSTEM / Panasonic AUTO

Select SIGNAL from the "SET UP" menu during VIDEO (S VIDEO) input signal mode. ("SIGNAL [VIDEO]" menu is displayed.)

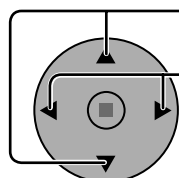

Press to select the "COLOR SYSTEM" or "Panasonic AUTO (4:3)".
Press to select each function.

If the image becomes unstable:

With the system set on Auto, under conditions of low level or noisy input signals the image may in rare cases become unstable. Should this occur, set the system to match the format of the input signal.

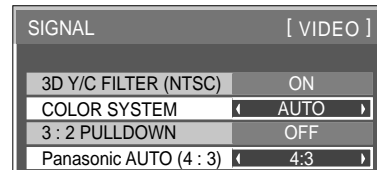

| Mode | Function |
|-------------------------------|--|
| COLOR SYSTEM | Set the color system to match the input signal. When selecting "AUTO", the color system is automatically selected from NTSC/PAL/SECAM, however, M.NTSC signal is not displayed properly depending on the attached terminal board. To display M.NTSC signal, select "M.NTSC" in COLOR SYSTEM. To display PAL60 signal, select "PAL" when BNC Dual Video Terminal Board (TY-FB9BD) is used. For other Video Terminal Boards, select "M.NTSC". <div style="text-align: center;"> → AUTO ← → PAL ← → SECAM ← → M.NTSC ← → NTSC ← </div> |
| Panasonic AUTO (4 : 3) | Set to "4:3" to view 4:3 images in an unchanged format when Panasonic AUTO is selected. If you would like to view 4:3 images in Just format, set to "JUST". |

Note:

Panasonic AUTO does not function when BNC Dual Video Terminal Board (TY-FB9BD) is used.

3:2 PULLDOWN

3:2 PULLDOWN: When ON, the display attempts to reproduce a more natural interpretation of sources such as movie pictures, which are recorded at 24 frames per second. If the picture is not stable, turn the setting to OFF.

Note:

When ON, this setting only affects the following signal input:

- NTSC / PAL signal input during "VIDEO (S VIDEO)" input signal.
- 525i(480i), 625i(575i), 1125(1080)/60i signal input during "COMPONENT" input signal.

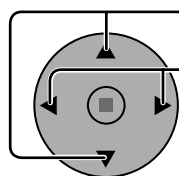

Press to select "3:2 PULLDOWN".
Press to set ON/OFF.



XGA MODE

This menu is displayed when the input signal is analog (Component/PC).

This unit supports three types of XGA signals with 60Hz vertical frequency having different aspect ratios and sampling rates (1,024 x 768 @ 60Hz, 1,280 x 768 @ 60Hz and 1,366 x 768 @ 60Hz).

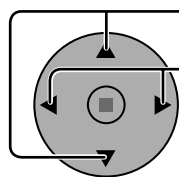

Press to select "XGA MODE".
Press to select "AUTO", "1024x768", "1280x768", "1366x768".

AUTO: Automatically selected from 1024x768/1280x768/1366x768.

Switch the setting to suit the input signal for better display depends on the angle of view or display resolution condition.



Note:

After making this setting, be sure to make each adjustment (such as "AUTO SETUP") on the "POS. /SIZE" menu as necessary. (see page 25)

REFRESH RATE

This function sets the refresh rate of the display.

This menu is displayed when the input signal is 50 Hz system (50i, 50p, 25p, 24p, 24sF) of vertical scan rate.

100 Hz: Reduce screen flicker.

50 Hz: Enhance the resolution of moving images.

Note:

It is recommended to set to 100 Hz normally.

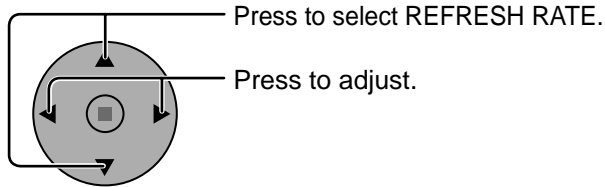

NOISE REDUCTION

Sets the following three NR (Noise Reduction) functions together.

VIDEO NR, MOSQUITO NR, BLOCK NR

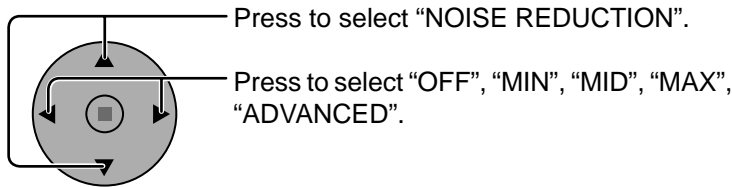

Advanced NR

Sets the three NR functions separately.

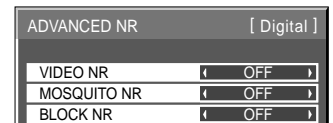
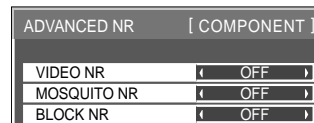
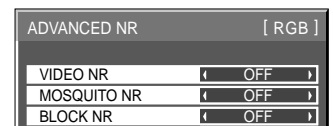
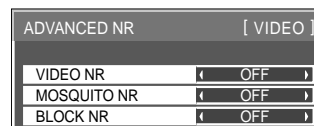
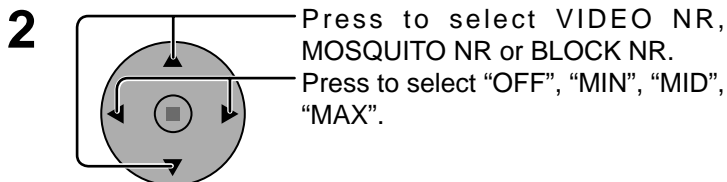
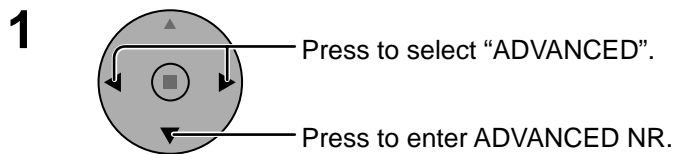

VIDEO NR: Automatically reduces unwanted picture noise.

MOSQUITO NR: Reduces mosquito noise around subtitles on MPEG videos.

BLOCK NR: Reduces block noise when playing MPEG videos.

Note:

NOISE REDUCTION cannot be adjusted while a PC signal is being applied.

SET UP for Input Signals

SYNC

Select SIGNAL from the “SET UP” menu during RGB input signal.

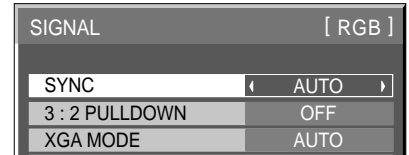
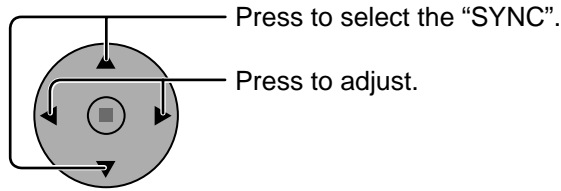

Setting RGB sync signal

Confirm that the input is set to RGB INPUT (this setting is valid only for RGB INPUT signal).

- AUTO:** The H and V sync or synchronized signal are automatically selected. If both input, it is selected the H and V sync.
- ON G:** Uses a synchronized signal on the Video G signal, which is input from the G connector.
- VBS:** Uses a synchronized signal of Composite Sync input, which is input from the HD connector.

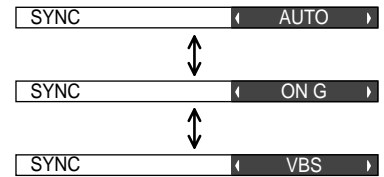

SDI THROUGH

Set the active through function of the Dual Link HD-SDI Terminal Board (TY-FB11DHD).

Note:

Settings can only be performed for this menu when a slot mounted with a Dual Link HD-SDI Terminal Board (TY-FB11DHD) is selected.

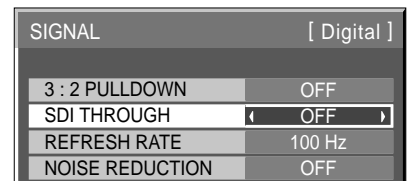
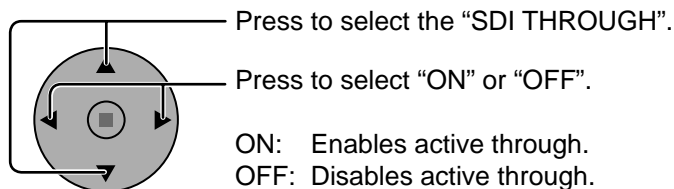

Input signal display

Displays the frequency and the type of the current input signal.

This display is valid only for COMPONENT/RGB/PC and Digital input signal.

Display range:



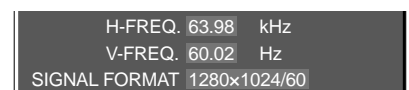

- Horizontal 15 - 110 kHz
- Vertical 48 - 120 Hz

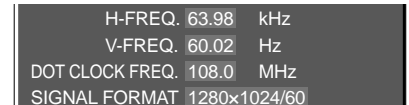



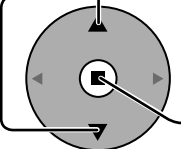
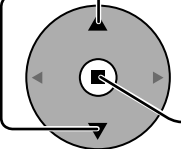
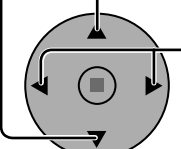
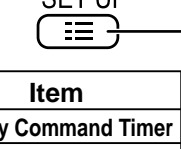

The dot clock frequency is displayed during digital signal input.



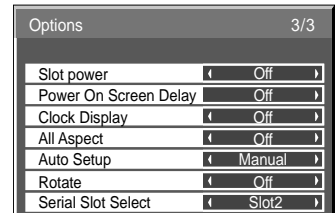
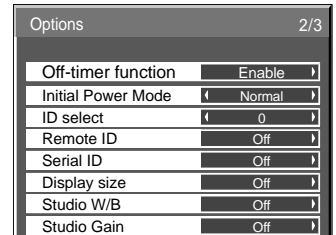
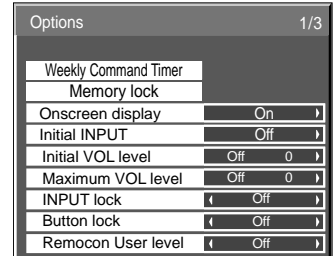













Options Adjustments

- 1  Press to display the SET UP menu.
- 2  Press to select "OSD LANGUAGE".
 Press for more than 3 seconds.
- 3  Press to select "Options".
 Press to display the Options menu.
- 4  Press to select your preferred menu.
 Press to adjust the menu.
- 5  Press to exit from Options menu.









| Item | Adjustments |
|-----------------------------|--|
| Weekly Command Timer | Sets Weekly Command Timer. (see page 58) |
| Memory lock | Locks or unlocks saved profiles. Also for setting passwords. (see page 33) |
| Onscreen display | <p>On: Displays all the following on screen.</p> <ul style="list-style-type: none"> • Power on display • Input signal switch display • No signal display • Mute and the remaining time of off-timer after  was pressed. <p>Off: Hides all the items above from view.</p> |
| Initial INPUT | <p>Off <=> PC <=> INPUT1 <=> INPUT2 <=> INPUT3 Adjusts the input signal when the unit is turned on.</p> <p>Notes:</p> <ul style="list-style-type: none"> • Only the adjusted signal is displayed. (see page 15) • Signal can be displayed when the Terminal board is installed. • This menu is available only when "INPUT lock" is "Off". • When a dual input terminal board is attached, A or B is displayed depending on the selected input signal. (Ex. INPUT1A, INPUT1B) |
| Initial VOL level | <p>Press  button to adjust the volume when the unit is turned on.</p> <p>Off <=> On</p> <p>Off: Sets normal volume. On: Sets your preferred volume.</p> <p>Notes:</p> <ul style="list-style-type: none"> • When "Maximum VOL level" is "On", the volume can only be adjusted between 0 and your maximum range. • You can hear the changed volume regardless of your volume setting before opening the options menu if you adjust the volume when "Initial VOL level" is "On" and cursor is on the menu. |
| Maximum VOL level | <p>Press  button to adjust the maximum volume.</p> <p>Off <=> On</p> <p>Off: Sets auto maximum volume. On: Sets your preferred maximum volume.</p> <p>Notes:</p> <ul style="list-style-type: none"> • If the "Maximum VOL level" is set lower than the "Initial VOL level", the "Initial VOL level" automatically becomes the same as the "Maximum VOL level". • The volume display can go up to 63 regardless of the settings. • You can hear the changed volume regardless of your volume setting before opening the options menu if you adjust the volume when "Maximum VOL level" is "On" and cursor is on the menu. |

Options Adjustments

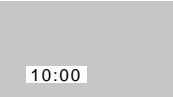

| Item | Adjustments |
|----------------------------------|---|
| <p>INPUT lock</p> | <p>Off ↔ PC ↔ INPUT1 ↔ INPUT2 ↔ INPUT3 Locks the input switch operation.</p> <p>Notes:</p> <ul style="list-style-type: none"> • Only the adjusted signal is displayed (see page 15). • Signal can be displayed when the Terminal board is installed. • Input switch can be used when this is set to “Off”. • In two screen display mode, if anything other than “Off” is set, the value will be fixed as the value input in the single screen display mode. • When a dual input terminal board is attached, A or B is displayed depending on the selected input signal. (Ex. INPUT1A, INPUT1B) |
| <p>Button lock</p> | <p>Off ↔ MENU&ENTER ↔ On Off: All the buttons at the right side of the main unit can be used.</p> <p>MENU&ENTER: Locks <input type="checkbox"/> MENU and <input type="checkbox"/> ENTER buttons on right side of main unit.</p> <p>On: Locks all the button on right side of main unit. Sets Button lock with the unit buttons in the following procedure.</p> <p>Off: Press <input type="checkbox"/> +/▲ four times→Press <input type="checkbox"/> INPUT four times→Press <input type="checkbox"/> -/▼ four times→Press <input type="checkbox"/> ENTER/■</p> <p>MENU&ENTER: Press <input type="checkbox"/> ENTER/■ four times→Press <input type="checkbox"/> +/▲ four times→Press <input type="checkbox"/> INPUT four times→Press <input type="checkbox"/> ENTER/■</p> <p>On: Press <input type="checkbox"/> -/▼ four times→Press <input type="checkbox"/> ENTER/■ four times→Press <input type="checkbox"/> +/▲ four times→Press <input type="checkbox"/> ENTER/■</p> |
| <p>Remocon User level</p> | <p>Off ↔ User1 ↔ User2 ↔ User3 Off: You can use all of the buttons on the remote control.</p> <p>User1: You can only use , , , , , , , , ,  buttons on the remote control.</p> <p>User2: You can only use ,  buttons on the remote control.</p> <p>User3: Locks all the buttons on remote control.</p> |
| <p>Off-timer function</p> | <p>Enable: Enables the “Off-timer function”.</p> <p>Disable: Disables the “Off-timer function”.</p> <p>Note: When “Disable” is set, the Off-timer is cancelled.</p> |
| <p>Initial Power Mode</p> | <p>Normal ↔ Standby ↔ On Sets the power mode of the unit for when the power recovers from failure or after plugging off and in again.</p> <p>Normal: Power returns in as the same state as before the power interruption.</p> <p>Standby: Power returns in standby mode. (Power Indicator : red/orange)</p> <p>On: Power returns in power On. (Power Indicator : green)</p> <p>Note: When using multiple displays, “Standby” is preferred to be set in order to reduce a power load.</p> |
| <p>ID select</p> | <p>Sets panel ID number when panel is used in “Remote ID” or “Serial ID”.</p> <p>Set value range: 0 - 100 (Standard value: 0)</p> |
| <p>Remote ID</p> | <p>The setting of this menu is valid only when using ID remote control.</p> <p>Off: Disables ID remote control functions. You can use normal remote control operations.</p> <p>On: Enable ID remote control functions.</p> <p>Note: To use the ID remote control function, it is necessary to set each ID number of remote control and display unit. About the setting method, please refer to “ID Remote Control Function” (see page 46) and “ID select” (above-mentioned).</p> |
| <p>Serial ID</p> | <p>Sets the panel ID Control.</p> <p>Off: Disables external control by the ID.</p> <p>On: Enables the external control by the ID.</p> |
| <p>Display size</p> | <p>Adjusts the image display size on screen.</p> <p>Off: Sets the normal image display size on screen.</p> <p>On: Sets the image display size approximately 95 % of the normal image display.</p> <div style="display: flex; justify-content: space-around; align-items: center;"> <div style="text-align: center;"> <p>Off</p>  </div> <div style="text-align: center;"> <p>On</p>  </div> </div> <p>Notes:</p> <ul style="list-style-type: none"> • This setting is valid only when the input signals are as follows; NTSC, PAL, SECAM, M.NTSC, PAL60, PAL-M, PAL-N (BNC Dual Video Terminal Board (TY-FB9BD)) 525i, 525p, 625i, 625p, 750/60p, 750/50p, 1125/60i, 1125/50i, 1125/24sF, 1125/25p, 1125/24p, 1125/30p, 1125/60p, 1125/50p, 1250/50i (Component Video, RGB, DVI, SDI, HDMI) • This setting is invalid when two screen display, digital zoom, Multi display or Portrait display is selected. • When “Display size” is set to “On”, “H-POS” and “V-POS” in “POS. /SIZE” can be adjusted. • Refer to each board’s operating instruction for DVI, SDI, HDMI’s corresponding signals. |

Options Adjustments

| Item | Adjustments |
|------------------------------|---|
| Studio W/B | <p>Off: Nullify all the settings adjusted.</p> <p>On: Sets the color temperature for TV studio.</p> <p>Note: Valid only when the "WARM" is set as "COLOR TEMP" in PICTURE menu.</p> |
| Studio Gain | <p>Sharpens the contrast for a better view when a part of the image is too light to see.</p> <p>Off: Disables "Studio Gain".</p> <p>On: Enables "Studio Gain".</p> <p>Note: This setting is valid only when the input signals are as follows: Component Video, RGB (analog), SDI, HDMI</p> |
| Slot Power | <p>Off ↔ Auto ↔ On</p> <p>Off: Power is not transmitted to the slot power.</p> <p>Auto: Power is transmitted to the slot power only when main power is on.</p> <p>On: Power is transmitted to the slot power when main power is on or in the standby state.</p> <p>Note: In some cases, power is transmitted to the slot power when main power is on or in the standby state regardless of the slot power setting.</p> |
| Power On Screen Delay | <p>Off ↔ 1 ↔ 2 ↔ 3.... ↔ 30</p> <p>You can set the power-on delay time of the displays to reduce the power load, when you press / to turn on the multiple displays that are set together, for example, on MULTI DISPLAY system. Set each display's setting individually.</p> <p>Off: The display will be turned on at the same time as / is pressed.</p> <p>1 to 30 (sec.): Set the power-on delay time (second). After pressing / , the display will be powered on with time delay depending on this setting.</p> <p>Notes:</p> <ul style="list-style-type: none"> • During this function is working, the power indicator is blinking green. • This function also works when the power recovers from failure or after plugging off and in again the power cord. After you unplug and plug the power cord in while the unit is in standby mode and also the power is being supplied to a terminal board, the unit will start supplying the power to the board with time delay according to the setting. The power indicator lights up red first and it turns orange when the power starts being supplied to the board. |
| Clock Display | <p>Off: Not display the clock.</p> <p>On: Display the clock.</p> <p>The clock is displayed at the lower left of the screen when  button is pressed.</p> <p>Note: When "PRESENT TIME SETUP" is not set, the clock is not displayed even if "Clock Display" is "On" (see page 36)</p>  |
| All Aspect | <p>Sets All Aspect mode (advanced aspect setting) or default aspect mode. With each press of  button, the aspect changes in the selected mode.</p> <p>Off: Default aspect mode</p> <p>On: All Aspect mode</p> <p>Aspect mode of each setting is as follows: (Example: HD signal)</p> <p>Off 4:3→H-FILL→ZOOM→FULL→JUST</p> <p>On 4:3 (1)→4:3 (2)→4:3 Full→Zoom1→Zoom2→Zoom3→16:9→14:9→Just1→Just2</p> |
| Auto Setup | <p>Sets the operational mode of the automatic position adjustment in the POS./SIZE menu.</p> <p>Manual: Automatic position adjustment starts when  is pressed on the remote control or automatic position adjustment is executed from the POS./SIZE menu.</p> <p>Auto: Other than remote control or menu operation, automatic position adjustment starts: When the display power is turned ON. When the input signal is switched.</p> |
| Rotate | <p>Off: Does not rotate the image.</p> <p>On: Rotates the image 180 degrees.</p> |
| Serial Slot Select | <p>Slot1 ↔ Slot2 ↔ Slot3</p> <p>Selects the slot which communicates serial.</p> <p>Note: The setting of an external command can be set only from the fixed serial terminal. (see page 11)</p> |

Normalization

When both main unit buttons and remote control are disabled due to the "Button lock", "Remocon User level" or "Remote ID" adjustments, set all the values "Off" so that all the buttons are enabled again.

Press the  -/▼ button on main unit together with  button on the remote control and hold for more than 5 seconds. The "Shipping" menu is displayed and the lock is released when it disappears.

Weekly Command Timer

You can set 7-day timer programming by setting time and command.

Note:

Before setting Weekly Command Timer, set PRESENT TIME SETUP. (see page 36)

- 1**

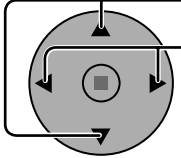
 - Press to select Function.
 - Press to select "On".

Note:

 - When Function is set to On, SET UP TIMER (see page 36) is unavailable and INTERVAL / TIME OF DAY in MODE of SCREENSAVER (see page 37) cannot be selected.

- 2**

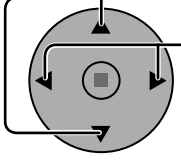
 - Press to select a day.
 - Press to select a program number.

Note:

 - You can set the program from 1 to 7. --- indicates unset.

- 3**

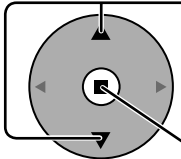

 - Press to select Program Edit.
 - Press to show the Program Edit screen.

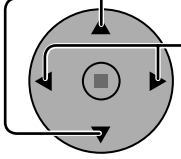
- 4**

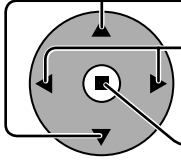

 - Press to select Program.
 - Press to change the program numbers (1-7).

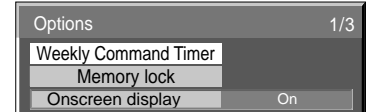
- 5**



 - Press to select a command number.
 - Press to show the previous / next command pages (1-8) of the selected program.
 - Press to show the command setting screen.

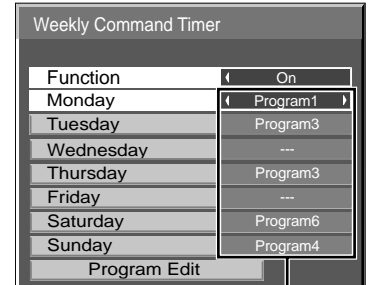

Press ACTION (■) button

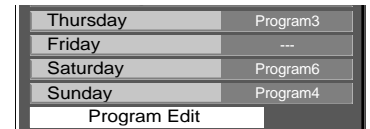

Program number



Program Edit screen

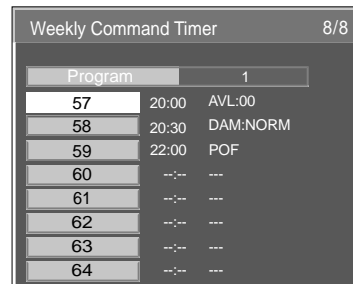
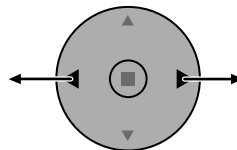
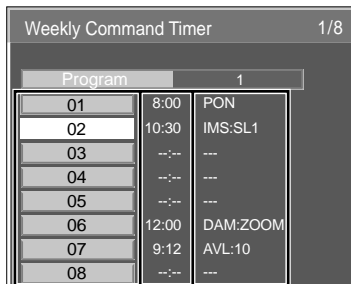
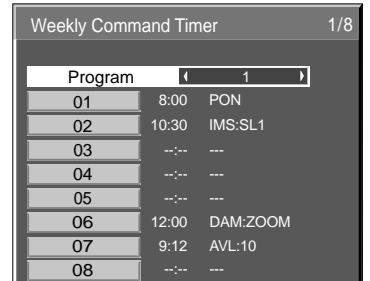

Command (--- indicates unset)
 Set time of timer (--:-- indicates unset)
 Command numbers

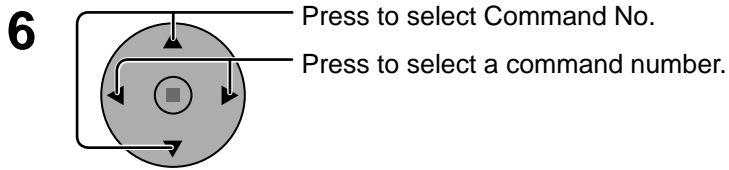

Command setting screen

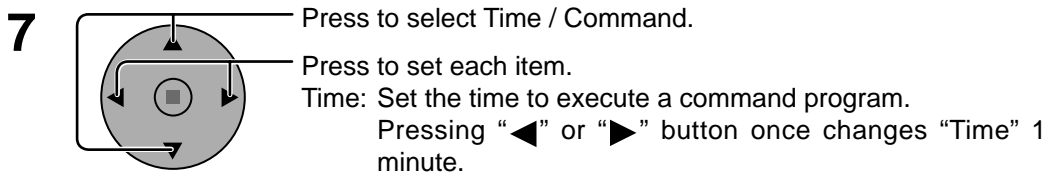
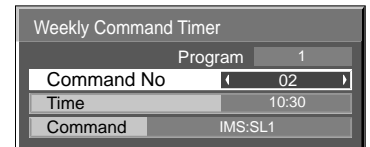

Time: Set the time to execute a command program.
Pressing “◀” or “▶” button once changes “Time” 1 minute.
Pressing “◀” or “▶” button continuously changes “Time” by 15 minutes.
Command: Select a command to execute at the set time. This unit has 64 commands to set. (see page 64)

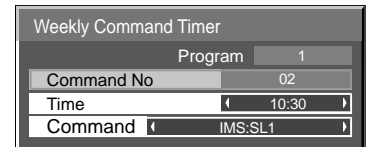

Notes:

- Command is performed in order of execution time, regardless of the command number.
- If a command execution time overlaps with that of other commands, these commands are performed in number order.
- Pressing \bigcirc^N , Time becomes --:-- and Command becomes ---.

Note:
Press \bigcirc^R to return to the previous screen.

Shipping condition

This function allows you to reset the unit to the factory setting.

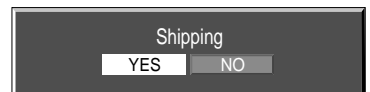
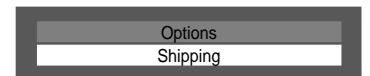
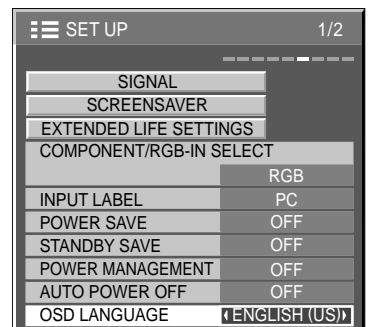
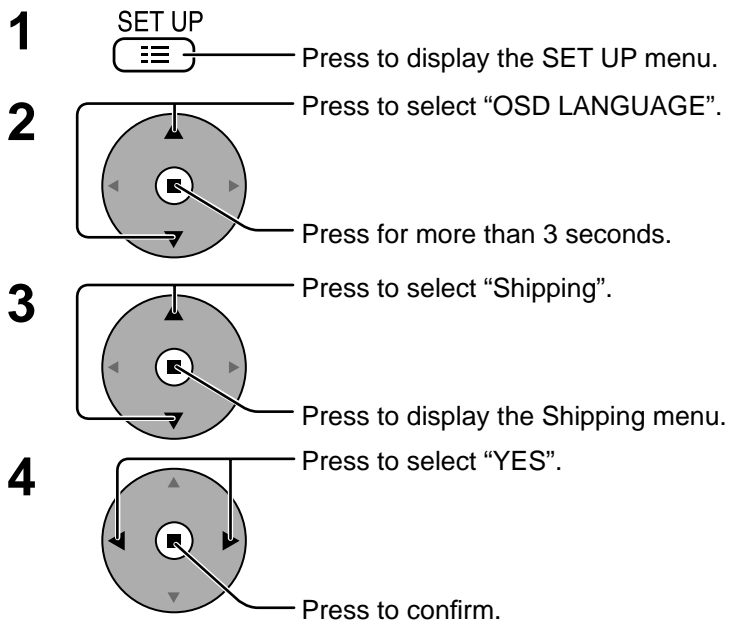











[from the unit]

- 1 Press the MENU button till the SET UP menu is displayed.
- 2 Press the Volume Up “+” or Down “-” button to select “OSD LANGUAGE”.
- 3 Press and hold the ENTER button till the Shipping menu is displayed.
- 4 Press the Volume Up “+” or Down “-” button to select “YES”.
- 5 Press the ENTER button and wait for 10 sec.

Troubleshooting

Before you call for service, determine the symptoms and make a few simple checks as shown below.

| Symptoms | | Checks |
|--|--|---|
| Picture | Sound | |
|  Interference |  Noisy Sound | Electrical Appliances Cars / Motorcycles Fluorescent light |
|  Normal Picture |  No Sound | Volume (Check whether the mute function has been activated on the remote control.) |
|  No Picture |  No Sound | Not plugged into AC outlet Not switched on PICTURE and BRIGHTNESS/Volume setting (Check by pressing the power switch or stand-by button on the remote control.) |
|  No Picture |  Normal Sound | If a signal with a non-applicable color system format, or frequency is input, only the input terminal indication is displayed. |
|  No Color |  Normal Sound | Color controls set at minimum level. (see page 28, 29) COLOR SYSTEM (see page 52) |
| No remote control operations can be performed. | | Check whether the batteries have discharged completely and, if they have not, whether they were inserted properly. Check whether the remote control sensor is exposed to an outdoor light or a strong fluorescent light. Check whether the remote control designed specifically for use with the unit is being used. (The unit cannot be operated by any other remote control.) |
| A cracking sound is sometimes heard from the unit. | | If there is nothing wrong with the picture or sound, this is the sound of the cabinet undergoing very slight contractions in response to changes in the room temperature. There are no adverse effects on the performance or other aspects. |
| The top or bottom of the picture on the screen is cut off when I use the zoom function. | | Adjust the position of the picture on the screen. |
| Areas at the top and bottom of the screen where the image is missing appear when I use the zoom function. | | When using a video software program (such as a cinema size program) with a screen wider than one in the 16:9 mode, blank areas separate from the images are formed at the top and bottom of the screen. |
| I can hear sounds coming from inside the unit. | | When the power is turned on, a sound of the display panel being driven may be heard: This is normal and not indicative of malfunctioning. |
| This Plasma Display uses special image processing. Hence a slight time lag may occur between image and audio, depending on the type of input signal. However, this is not a malfunction. | | |

Plasma Display panel

| Symptoms | Check |
|--|--|
| The screen darkens slightly when bright pictures with minimal movements are shown. | The screen will darken slightly when photos, still images of a computer or other pictures with minimal movements are shown for an extended period. This is done to reduce image retention on the screen and the shortening of the screen's service life: It is normal and not indicative of malfunctioning. |
| It takes a while for the picture to appear. | The unit digitally processes the various signals in order to reproduce esthetically pleasing images. As such, it sometimes takes a few moments for the picture to appear when the power has been turned on, when the input has been switched or when the images for the main picture and sub picture on the two screens are swapped. |
| The edges of the images flicker. | Due to the characteristics of the system used to drive the panel, the edges may appear to flicker in the fast-moving parts of the images: This is normal and not indicative of malfunctioning. |
| The brightness on both sides of images in 4:3 mode changes. | When viewing the side panels at the "BRIGHT" or "MID" setting, the brightness on both sides may change depending on the kind of program shown: This is normal and not indicative of malfunctioning. |
| Some parts of the screen do not light up. | The plasma display panel is manufactured using an extremely high level of precision technology, however, sometimes some parts of the screen may be missing picture elements or have luminous spots. This is not a malfunction. |
|  Image retention appears | Do not allow a still picture to be displayed for an extended period, as this can cause a permanent image retention to remain on the Plasma Display. Examples of still pictures include logos, video games, computer images, teletext and images displayed in 4:3 mode. Note: The permanent image retention on the Plasma Display resulting from fixed image use is not an operating defect and as such is not covered by the Warranty. This product is not designed to display fixed images for extended periods of time. |
| Whirring sounds can be heard from the display unit. | The display unit is fitted with a cooling fan to dissipate heat generated during normal use. The whirring sound is caused by rotation of the fan and is not a malfunction. |

List of Aspect Modes

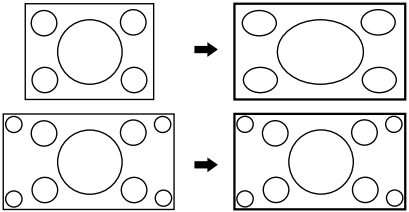
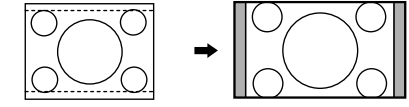
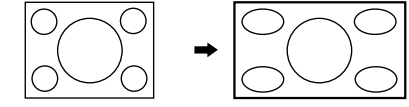
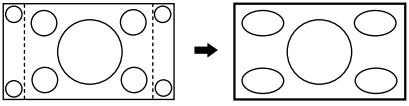
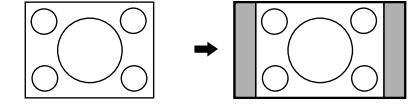
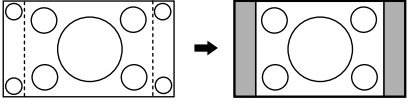
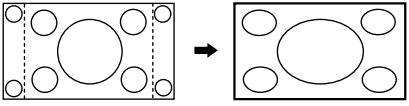
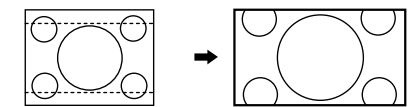
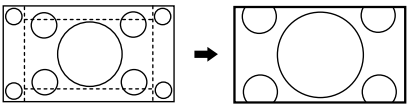
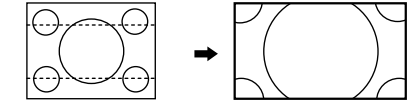
| Aspect mode | | Picture → Enlarged screen | Description |
|-------------------------|------------------------------------|---|---|
| All Aspect: On | Factory setting All Aspect: Off | | |
| 16:9 | FULL |  | The display of the pictures fills the screen. In the case of SD signals, pictures with a 4:3 aspect ratio are enlarged horizontally, and displayed. This mode is suited to displaying anamorphic pictures with a 16:9 aspect ratio. |
| 14:9 | – |  | Letterbox pictures with a 14:9 aspect ratio are enlarged vertically and horizontally so that their display fills the screen vertically and is slightly smaller than the screen horizontally. The top and bottom edges of the pictures are cut off. Side panels are displayed at the left and right edges of the screen. |
| Just ----- Just1 | JUST |  | Pictures with a 4:3 aspect ratio are enlarged horizontally so that the picture distortion is minimized. The display of the areas around the left and right edges of the screen is slightly elongated. |
| Just2 | JUST |  | Pictures with a 4:3 aspect ratio are enlarged horizontally so that the picture distortion is minimized. The left and right edges of the pictures are cut off. The display of the areas around the left and right edges of the screen is slightly elongated. |
| 4:3 ----- 4:3 (1) | 4:3 |  | Pictures with a 4:3 aspect ratio are displayed with their original aspect ratio. Side panels are displayed at the left and right edges of the screen. |
| 4:3 (2) | 4:3 |  | Pictures with a 4:3 aspect ratio are displayed with their original aspect ratio. The left and right edges of the pictures are masked by side panels. |
| 4:3 Full | H-FILL |  | Pictures with a 4:3 aspect ratio are enlarged horizontally so that their display fills the screen. The left and right edges of the pictures are cut off. |
| Zoom ----- Zoom1 | ZOOM |  | Letterbox pictures with a 16:9 aspect ratio are enlarged vertically and horizontally so that their display fills the screen. The top and bottom edges of the pictures are cut off. |
| Zoom2 | ZOOM |  | Letterbox pictures with a 16:9 aspect ratio are enlarged vertically and horizontally so that their display fills the screen. The top and bottom edges as well as the left and right edges of the pictures are cut off. |
| Zoom3 | – |  | Letterbox pictures with a 2.35:1 aspect ratio are enlarged vertically and horizontally so that their display fills the screen vertically and is slightly larger than the screen horizontally. The top and bottom edges as well as the left and right edges of the pictures are cut off. |

Applicable Input Signals

*Mark: Applicable input signal

| | Signal name | Horizontal frequency (kHz) | Vertical frequency (Hz) | COMPONENT / RGB IN / PC IN (Dot clock (MHz)) | DVI-D IN *8 (Dot clock (MHz)) |
|----|----------------------------|----------------------------|-------------------------|--|-------------------------------|
| 1 | 525 (480) / 60i | 15.73 | 59.94 | * (13.5) | |
| 2 | 525 (480) / 60p | 31.47 | 59.94 | * (27.0) *5 | * (27.0) |
| 3 | 625 (575) / 50i | 15.63 | 50.00 | * (13.5) | |
| 4 | 625 (575) / 50p | 31.25 | 50.00 | * (27.0) | |
| 5 | 625 (576) / 50p | 31.25 | 50.00 | | * (27.0) |
| 6 | 750 (720) / 60p | 45.00 | 60.00 | * (74.25) | * (74.25) |
| 7 | 750 (720) / 50p | 37.50 | 50.00 | * (74.25) | * (74.25) |
| 8 | 1,125 (1,080) / 60p | 67.50 | 60.00 | * (148.5) *1 | * (148.5) |
| 9 | 1,125 (1,080) / 60i | 33.75 | 60.00 | * (74.25) *1 | * (74.25) |
| 10 | 1,125 (1,080) / 50p | 56.26 | 50.00 | * (148.5) *1 | * (148.5) |
| 11 | 1,125 (1,080) / 50i | 28.13 | 50.00 | * (74.25) *1 | * (74.25) |
| 12 | 1,125 (1,080) / 24sF | 27.00 | 48.00 | * (74.25) *2 | |
| 13 | 1,125 (1,080) / 30p | 33.75 | 30.00 | * (74.25) *1 | * (74.25) |
| 14 | 1,125 (1,080) / 25p | 28.13 | 25.00 | * (74.25) *1 | * (74.25) |
| 15 | 1,125 (1,080) / 24p | 27.00 | 24.00 | * (74.25) *1 | * (74.25) |
| 16 | 1,250 (1,080) / 50i | 31.25 | 50.00 | * (74.25) *3 | |
| 17 | 2,048 x 1,080 / 24sF *7 | 27.00 | 48.00 | | |
| 18 | 2,048 x 1,080 / 24p *7 | 27.00 | 24.00 | | |
| 19 | 640 x 400 @70 Hz | 31.46 | 70.07 | * (25.17) | |
| 20 | 640 x 480 @60 Hz | 31.47 | 59.94 | * (25.18) *6 | * (25.18) |
| 21 | 640 x 480 @72 Hz | 37.86 | 72.81 | * (31.5) | |
| 22 | 640 x 480 @75 Hz | 37.50 | 75.00 | * (31.5) | |
| 23 | 640 x 480 @85 Hz | 43.27 | 85.01 | * (36.0) | |
| 24 | 800 x 600 @56 Hz | 35.16 | 56.25 | * (36.0) | |
| 25 | 800 x 600 @60 Hz | 37.88 | 60.32 | * (40.0) | * (40.0) |
| 26 | 800 x 600 @72 Hz | 48.08 | 72.19 | * (50.0) | |
| 27 | 800 x 600 @75 Hz | 46.88 | 75.00 | * (49.5) | |
| 28 | 800 x 600 @85 Hz | 53.67 | 85.06 | * (56.25) | |
| 29 | 852 x 480 @60 Hz | 31.47 | 59.94 | * (33.54) *6 | * (34.24) |
| 30 | 1,024 x 768 @50 Hz | 39.55 | 50.00 | | * (51.89) |
| 31 | 1,024 x 768 @60 Hz | 48.36 | 60.00 | * (65.0) | * (65.0) |
| 32 | 1,024 x 768 @70 Hz | 56.48 | 70.07 | * (75.0) | |
| 33 | 1,024 x 768 @75 Hz | 60.02 | 75.03 | * (78.75) | |
| 34 | 1,024 x 768 @85 Hz | 68.68 | 85.00 | * (94.5) | |
| 35 | 1,066 x 600 @60 Hz | 37.64 | 59.94 | * (53.0) | * (53.0) |
| 36 | 1,152 x 864 @60 Hz | 53.70 | 60.00 | | * (81.62) |
| 37 | 1,152 x 864 @75 Hz | 67.50 | 75.00 | * (108.0) | |
| 38 | 1,280 x 768 @60 Hz | 47.70 | 60.00 | * (80.14) | |
| 39 | 1,280 x 960 @60 Hz | 60.00 | 60.00 | * (108.0) | |
| 40 | 1,280 x 960 @85 Hz | 85.94 | 85.00 | * (148.5) | |
| 41 | 1,280 x 1,024 @60 Hz | 63.98 | 60.02 | * (108.0) | * (108.0) |
| 42 | 1,280 x 1,024 @75 Hz | 79.98 | 75.03 | * (135.0) | |
| 43 | 1,280 x 1,024 @85 Hz | 91.15 | 85.02 | * (157.5) | |
| 44 | 1,366 x 768 @50 Hz | 39.55 | 50.00 | | * (69.92) |
| 45 | 1,366 x 768 @60 Hz | 48.36 | 60.00 | * (86.71) | * (87.44) |
| 46 | 1,400 x 1,050 @60 Hz | 65.22 | 60.00 | | * (122.61) |
| 47 | 1,600 x 1,200 @60 Hz | 75.00 | 60.00 | * (162.0) | * (162.0) |
| 48 | 1,600 x 1,200 @65 Hz | 81.25 | 65.00 | * (175.5) | |
| 49 | 1,920 x 1,080 @60 Hz | 67.50 | 60.00 | * (148.5) *4 | * (148.5) |
| 50 | 1,920 x 1,200 @60 Hz | 74.04 | 59.95 | | * (154.0) |
| 51 | Macintosh13" (640 x 480) | 35.00 | 66.67 | * (30.24) | |
| 52 | Macintosh16" (832 x 624) | 49.72 | 74.54 | * (57.28) | |
| 53 | Macintosh21" (1,152 x 870) | 68.68 | 75.06 | * (100.0) | |

*1: Based on SMPTE 274M standard.

*2: Based on SMPTE RP211 standard.

*3: Based on SMPTE 295M standard.

*4: The input signal is recognized as 1,125 (1,080) / 60p.

*5: When selected the RGB format and 525p signal input to the Mini D-sub 15P terminal, it is recognized as VGA 60Hz signal.

*6: When inputted VGA 60Hz format signal from the other than Mini D-sub 15P terminal, it is recognized as 525p signal.

*7: Based on SMPTE 292M and 372M standards. These signals can be received when the Dual Link HD-SDI Terminal Board (TY-FB11DHD) is installed.

*8: These signals can be received when the DVI-D Terminal Board (TY-FB11DD) is installed.

Note: Signals without above specification may not be displayed properly.

VIDEO input (HDMI)

| Signal format | Vertical frequency (Hz) | Horizontal frequency (kHz) | Dot clock (MHz) | Number of active pixels | Total number of pixels | Number of active lines | Total number of lines |
|----------------|-------------------------|----------------------------|-----------------|-------------------------|------------------------|------------------------|-----------------------|
| 1 VGA60 | 59.94 | 31.47 | 25.18 | 640 | 800 | 480 | 525 |
| 2 525/60p | 59.94 | 31.47 | 27.00 | 720 | 858 | 480 | 525 |
| 3 625/50p | 50.00 | 31.25 | 27.00 | 720 | 864 | 576 | 625 |
| 4 750/60p | 60.00 | 45.00 | 74.25 | 1280 | 1650 | 720 | 750 |
| 5 750/50p | 50.00 | 37.50 | 74.25 | 1280 | 1980 | 720 | 750 |
| 6 1125/60i | 60.00 | 33.75 | 74.25 | 1920 | 2200 | 1080 | 1125 |
| 7 1125/50i | 50.00 | 28.13 | 74.25 | 1920 | 2640 | 1080 | 1125 |
| 8 1125/60p* | 60.00 | 67.50 | 148.50 | 1920 | 2200 | 1080 | 1125 |
| 9 1125/50p* | 50.00 | 56.26 | 148.50 | 1920 | 2640 | 1080 | 1125 |
| 10 1125/24p* | 24.00 | 27.00 | 74.25 | 1920 | 2750 | 1080 | 1125 |

*Not compatible with HDMI Terminal Board (TY-FB8HM).

Audio signal Linear PCM : 48/44.1/32 kHz

Command list of Weekly Command Timer

| No. | Command | Control details |
|-----|--------------|--|
| 1 | AAC:MENCLR*1 | Audio Menu (Clear) |
| 2 | AAC:MENDYN*1 | Audio Menu (Dynamic) |
| 3 | AAC:MENSTD*1 | Audio Menu (Standard) |
| 4 | AAC:SURMON | Surround (ON) |
| 5 | AAC:SUROFF | Surround (OFF) |
| 6 | AMT:0 | Audio Mute (OFF) |
| 7 | AMT:1 | Audio Mute (ON) |
| 8 | ASO:M | Audio out when PIP mode (Main Picture) |
| 9 | ASO:S | Audio out when PIP mode (Sub Picture) |
| 10 | AVL:00 | Audio Volume (00) |
| 11 | AVL:10 | Audio Volume (10) |
| 12 | AVL:20 | Audio Volume (20) |
| 13 | AVL:30 | Audio Volume (30) |
| 14 | AVL:40 | Audio Volume (40) |
| 15 | AVL:50 | Audio Volume (50) |
| 16 | AVL:60 | Audio Volume (60) |
| 17 | DAM:FULL | Aspect (FULL) |
| 18 | DAM:JUST | Aspect (JUST) |
| 19 | DAM:NORM | Aspect (4:3) |
| 20 | DAM:SELF | Aspect (Panasonic Auto) |
| 21 | DAM:ZOOM | Aspect (ZOOM) |
| 22 | DWA:OFF | Dual Picture mode (OFF) |
| 23 | DWA:OVL1 | Advanced PIP mode (1) (see page 19) |
| 24 | DWA:OVL2 | Advanced PIP mode (2) (see page 19) |
| 25 | DWA:OVL3 | Advanced PIP mode (3) (see page 19) |
| 26 | DWA:OVL4 | Advanced PIP mode (4) (see page 19) |
| 27 | DWA:OVL5 | Advanced PIP mode (5) (see page 19) |
| 28 | DWA:OVL6 | Advanced PIP mode (6) (see page 19) |
| 29 | DWA:OVLOF | Advanced PIP mode (OFF) (normal two screen display mode) |
| 30 | DWA:OVLON | Advanced PIP mode (ON) |
| 31 | DWA:PIN0 | The location of the sub picture (lower right) |
| 32 | DWA:PIN1 | The location of the sub picture (lower left) |
| 33 | DWA:PIN2 | The location of the sub picture (upper left) |
| 34 | DWA:PIN3 | The location of the sub picture (upper right) |
| 35 | DWA:PIP | Dual Picture mode (Picture in Picture) |
| 36 | DWA:POP | Dual Picture mode (Picture out Picture) |
| 37 | DWA:SWP | Swap main picture and sub picture when PIP mode |
| 38 | DWA:TWN | Dual Picture mode (Picture and Picture) |
| 39 | IMS:PC1 | Input select (PC1) (Main Picture when PIP mode) |
| 40 | IMS:SL1 | Input select (SLOT1) (Main Picture when PIP mode) |
| 41 | IMS:SL1A | Input select (SLOT1A) (Main Picture when PIP mode) |
| 42 | IMS:SL1B | Input select (SLOT1B) (Main Picture when PIP mode) |
| 43 | IMS:SL2 | Input select (SLOT2) (Main Picture when PIP mode) |
| 44 | IMS:SL2A | Input select (SLOT2A) (Main Picture when PIP mode) |
| 45 | IMS:SL2B | Input select (SLOT2B) (Main Picture when PIP mode) |
| 46 | IMS:SL3 | Input select (SLOT3) (Main Picture when PIP mode) |
| 47 | ISS:PC1 | Sub Picture Input Select (PC1) |
| 48 | ISS:SL1 | Sub Picture Input Select (SLOT1) |
| 49 | ISS:SL1A | Sub Picture Input Select (SLOT1A) |
| 50 | ISS:SL1B | Sub Picture Input Select (SLOT1B) |
| 51 | ISS:SL2 | Sub Picture Input Select (SLOT2) |
| 52 | ISS:SL2A | Sub Picture Input Select (SLOT2A) |
| 53 | ISS:SL2B | Sub Picture Input Select (SLOT2B) |
| 54 | ISS:SL3 | Sub Picture Input Select (SLOT3) |
| 55 | OSP:SCR0 | Screen Saver SCROLLING BAR ONLY (OFF) |
| 56 | OSP:SCR1 | Screen Saver SCROLLING BAR ONLY (ON) |
| 57 | POF | Power OFF |
| 58 | PON | Power ON |
| 59 | SSC:FNC0 | Screen Saver function (SCROLLING BAR ONLY) |
| 60 | SSC:FNC1 | Screen Saver function (NEGATIVE IMAGE) |
| 61 | SSC:MOD0 | Screen Saver (Mode (OFF)) |
| 62 | SSC:MOD3 | Screen Saver (Mode (ON)) |
| 63 | VMT:0*2 | Picture Mute (OFF) |
| 64 | VMT:1*2 | Picture Mute (ON) |

*1 These commands are unavailable on this model.

*2 Picture Mute cannot be unlocked by powering off/on with the remote control. Turn off and on again with the button on the unit or enter the command VMT:0 to unlock Picture Mute.

Specifications

| TH-103PF12U | |
|-------------------------------|--|
| Power Source | 200-240 V AC, 50/60 Hz |
| Power Consumption | |
| Power on | 1,400 W |
| Stand-by condition | Save OFF 1.2 W, Save ON 0.7 W |
| Power off condition | 0.4 W |
| Plasma Display panel | Drive method : AC type 103-inch, 16:9 aspect ratio |
| Screen size | 89.3" (2,269 mm) (W) × 50.2" (1,276 mm) (H) × 102.4" (2,603 mm) (diagonal) |
| (No.of pixels) | 2,073,600 (1,920 (W) × 1,080 (H)) [5,760 × 1,080 dots] |
| Operating condition | |
| Temperature | 32 °F - 104 °F (0 °C - 40 °C) |
| Humidity | 20 % - 80 % |
| Applicable signals | |
| Scanning format | 525 (480) / 60i · 60p, 625 (575) / 50i · 50p, 750 (720) / 60p · 50p, 1125 (1080) / 60i · 60p · 50i · 50p · 24p · 25p · 30p · 24sF, 1250 (1080) / 50i |
| PC signals | VGA, SVGA, XGA, SXGA UXGA (compressed) Horizontal scanning frequency 15 - 110 kHz Vertical scanning frequency 48 - 120 Hz |
| Connection terminals | |
| HDMI A-B | TYPE A Connector × 2 |
| COMPONENT/RGB IN | Y/G (BNC) with sync 1.0 Vp-p (75 Ω) P _B /B (BNC), P _R /R (BNC) 0.7 Vp-p (75 Ω) AUDIO IN (RCA PIN JACK × 2) 0.5 Vrms |
| PC IN | (HIGH-DENSITY MINI D-SUB 15PIN) Y or G with sync 1.0 Vp-p (75 Ω) Y or G without sync 0.7 Vp-p (75 Ω) B/P _B /C _B : 0.7 Vp-p (75 Ω) R/P _R /C _R : 0.7 Vp-p (75 Ω) HD/VD: 1.0 - 5.0 Vp-p (high impedance) AUDIO IN (M3 JACK) 0.5 Vrms |
| SERIAL | EXTERNAL CONTROL TERMINAL (D-SUB 9PIN) RS-232C COMPATIBLE |
| AUDIO OUT | RCA PIN JACK × 2 (L / R) OUTPUT LEVEL : VARIABLE (-∞ — 0 dB) [INPUT 1 kHz / 0 dB, 10 kΩ Load] |
| Accessories Supplied | |
| Remote Control Transmitter | EUR7636070R |
| Batteries | AA Size × 2 |
| Fixing band | TMME203 × 2 |
| Dimensions (W × H × D) | 95.0" (2,412 mm) × 55.9" (1,419 mm) × 5.1" (129 mm) (5.6" (141 mm) when including protruding portion of slots) |
| Mass (weight) | approxox. 443.2 lbs |

Note:

Design and specifications are subject to change without notice. Mass and dimensions shown are approximate.

(for the U.S.A and Puerto Rico)

Panasonic Professional Display Company
Unit of Panasonic Corporation of
North America
One Panasonic Way 1F-10
Secaucus, NJ 07094

**Panasonic Professional Flat Panel Display
Limited Warranty**

Panasonic Professional Display Company. (referred to as "the Warrantor") will repair this product and all included accessories with new or refurbished parts, free of charge in the USA or Puerto Rico, of the original purchase in the event of a defect in materials or workmanship as follows:

| Models or Parts | Part Warranty | Labor Warranty |
|---------------------------------|----------------------|-----------------------|
| Professional Flat Panel Display | 3 Years | 3 Years |

On-site or carry-in service in the **USA and Puerto Rico** may be obtained during the warranty period by contacting Panasonic Professional Display Company Service toll free at 1-800-973-4390.

This warranty is extended only to the original purchaser and is non transferable. A purchase receipt or other proof of date of original purchase will be required before warranty service is rendered.

This warranty only covers failures due to defects in materials or workmanship, which occur during normal use. The warranty does not cover damage which occur in shipment, or failures which are caused by products not supplied by the warrantor, or failures which result from improper installation, set-up adjustments, improper

antenna, inadequate signal pickup, maladjustment of consumer controls, improper operation, power line surge, improper voltage supply, lighting damage, or service by anyone other than an authorized repair facility, or damage that is attributable to acts of God.

LIMITS AND EXCLUSIONS

There are no express warranties except as listed above.

THE WARRANTOR SHALL NOT BE LIABLE FOR INCIDENTAL OR CONSEQUENTIAL DAMAGES (INCLUDING, WITHOUT LIMITATION, DAMAGE TO DISCS) RESULTING FROM THE USE OF THIS PRODUCT, OR ARISING OUT OF ANY BREACH OF THE WARRANTY. ALL EXPRESS AND IMPLIED WARRANTIES, INCLUDING THE WARRANTIES OF MERCHANTABILITY AND FITNESS FOR PARTICULAR PURPOSE, ARE LIMITED TO THE APPLICABLE WARRANTY PERIOD SET FORTH ABOVE.

Some states do not allow the exclusion or limitation of incidental or consequential damages, or limitations on how long an implied warranty lasts, so the above exclusions or limitations may not apply to you. This warranty gives you specific legal rights and you may have other rights, which vary from state to state.

If you have a problem with this product that is not handled to your satisfaction, then write the Consumer Affairs Department at the Company address indicated above.

In the USA and Puerto Rico
FOR SERVICE
CALL TOLL FREE
1-800-973-4390

(for Canada)

Panasonic Canada Inc.
5770 Ambler Drive, Mississauga, Ontario L4W 2T3
LIMITED WARRANTY STATEMENT

Panasonic Canada Inc. (also known as PCI) warrants this product to be free of defects in material and workmanship under normal use during the applicable warranty coverage period described below. PCI agrees to repair, or at its option, exchange, any part that becomes defective. However, the product must be purchased and serviced in Canada. The product or part that shows evidence of defect must be delivered prepaid or carried in to an authorized Panasonic Broadcast Service Center. This warranty does not cover shipping costs.

The warranty coverage period is one year for both parts and labour beginning with the date of original end user purchase, subject to the exceptions as stated below. Repaired or replacement parts supplied during the warranty coverage period carry the unexpired portion of the original warranty coverage period. Proof of product purchase is a condition of warranty service. The owner must produce the product purchase receipt or other satisfactory evidence of date of original purchase.

This warranty does not apply to external appearance items, such as handles, knobs, safety windows, etc. This warranty does not apply to any part, or parts, of the product, installed, altered, repaired or misused in any way that, in the opinion of PCI, affects the reliability of or detracts from the performance of the product.

For products requiring routine preventive maintenance, that maintenance must be performed in order to maintain warranty coverage.

Serial numbers that have been altered, defaced or removed void this warranty. This warranty does not cover replacements or repairs necessitated by loss or damage resulting from any cause beyond the control of PCI.

Marking or retained images (sometimes called "burn-in") resulting from the display of fixed images on video display products are not defects and are not covered under this warranty.

THIS EXPRESS, LIMITED WARRANTY IS IN LIEU OF ALL OTHER WARRANTIES, EXPRESS OR IMPLIED, INCLUDING ANY IMPLIED WARRANTIES OF MERCHANTABILITY AND FITNESS FOR A PARTICULAR PURPOSE. IN NO EVENT WILL PANASONIC CANADA INC. BE LIABLE FOR ANY SPECIAL, INDIRECT OR CONSEQUENTIAL DAMAGES.

In certain instances, some jurisdictions do not allow the exclusion or limitation of incidental or consequential damages, or the exclusion of implied warranties, so the above limitations and exclusions may not be applicable.

WARRANTY COVERAGE PERIOD EXCEPTIONS

| Item | Parts | Labour |
|--|---|--|
| Video Tape | 30 days—Replacement only (content not covered) | N/A |
| P2/SD Cards | (Content not covered) | N/A |
| Video Heads | 1 year or 2,000 hrs. (prorated) Whichever comes first | 1 year or 2,000 hrs. Whichever comes first |
| D5 Video heads | 1 year or 1,000 hrs. Whichever comes first | 1 year or 1,000 hrs. Whichever comes first |
| Maintenance Items | 90 days | 90 days |
| Colour Camera CCD Imaging Block | 2 years | 1 year |
| BT-H Series LCD Monitors | 2 years | 1 year |
| * DLP™ Projectors | 3 years or 17,000 hrs. Whichever comes first | 3 years or 17,000 hrs. Whichever comes first |
| * LCD Projectors above 2,500 ANSI Lumens | 3 years or 2,500 hrs. Whichever comes first | 3 years or 2,500 hrs. Whichever comes first. |
| * LCD Projectors below 2,500 ANSI Lumens | 3 years or 1,500 hrs. Whichever comes first | 3 years or 1,500 hrs. Whichever comes first |
| Projector Lamps | 50% of the rated lamp life or 1 year. Whichever comes first | 50% of the rated lamp life or 1 year. Whichever comes first. |
| 103 inch Plasma displays | 3 year (burn-in not covered) | 3 year |
| Hard Drive Disk Unit | 1 year plus balance (if any) of the original Manufacturer's Limited Warranty. (Content not covered) | 1 year |

- * Dust, smoke, rental/staging environment and twenty-four/seven operation, dramatically decreases the interval between performances of routine preventive maintenance required to maintain this warranty coverage.

Warranty Service

If the product needs to be shipped for service, carefully pack (preferably in the original carton) and enclose a letter, detailing the complaint. Send prepaid and adequately insured to the local authorized Panasonic Service Centre in your area or to Panasonic Technical Support and Product Services Department, 5770 Ambler Drive, Mississauga, Ontario, L4W 2T3. Shipping to the latter location requires a return authorization before shipment. No liability is assumed for loss or damage to the product while in transit.

Customer Service

Customer Service Directory

Obtain information products and operative assistant; localize the closer distributor or Service Center; buy spare parts and accessories by our web site to Latin American:

<http://www.lar.panasonic.com>

Also you may contact us directly by our Contact Center:

| | |
|--------------------|--|
| Panama | 800-PANA (800-7262) |
| Colombia | 1-8000-94PANA (1-8000-947262) - National Line 635-PANA (635-7262) - Bogota Line |
| Ecuador | 1800-PANASONIC (1800-726276) |
| Costa Rica | 800-PANA737 (800-7262737) |
| El Salvador | 800-PANA (800-7262) |
| Guatemala | 1-801-811-PANA (1-801-811-7262) |
| Chile | 800-260602 From a cell phone: 245-2520 |
| Venezuela | 800-PANA-800 (800-7262-800) |
| Uruguay | 0-800-PANA (0800-7262) |

Mexico Service

To obtain information in the Republic of Mexico contact us at:

[email: atencion.clientes@mx.panasonic.com](mailto:atencion.clientes@mx.panasonic.com)

Or you may contact us in the next following phones numbers:

01800-VIP-PANA (01800-847-7262) - Interior
(55) 5000-1200 - Mexico D.F. and Metropolitan Area

Customer's Record

The model number and serial number of this product can be found on its back cover. You should note this serial number in the space provided below and retain this book, plus your purchase receipt, as a permanent record of your purchase to aid in identification in the event of theft or loss, and for Warranty Service purposes.

Model Number _____

Serial Number _____

© Panasonic Corporation 2009

Panasonic Professional Display Company
Unit of Panasonic Corporation of North America

Executive Office :
One Panasonic Way 1F-10, Secaucus, NJ 07094

Panasonic Canada Inc.
5770 Ambler Drive
Mississauga, Ontario
L4W 2T3

Printed in Japan
M1009S0