



JVC

COLOUR VIDEO MONITOR

TM-2100PN-K

INSTRUCTIONS

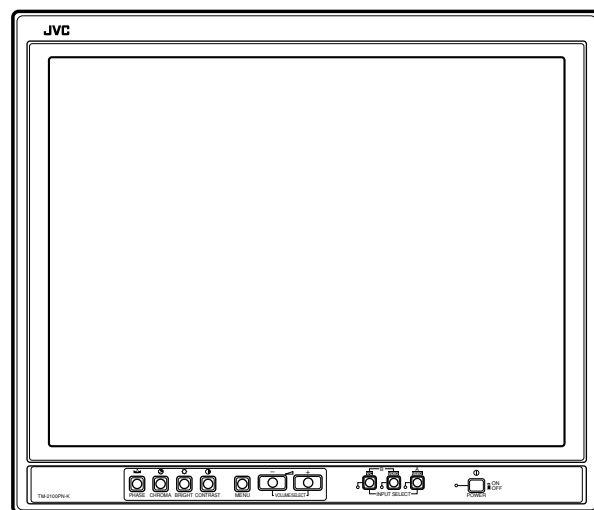

LCT0054-002A-H



Thank you for purchasing this JVC colour video monitor. Before using it, read and follow all instructions carefully to take full advantage of the monitor's capabilities.

SAFETY PRECAUTIONS

In order to prevent any fatal accidents caused by misoperation or mishandling the monitor, be fully aware of all the following precautions.

WARNINGS

To prevent fire or shock hazard, do not expose this monitor to rain or moisture. Dangerous high voltages are present inside the unit. Do not remove the back cover of the cabinet. When servicing the monitor, consult qualified service personnel. Never try to service it yourself.

Machine Noise Information Ordinance 3. GSGV, January 18, 1991: The sound pressure level at the operator position is equal or less than 70 dB(A) according to ISO 7779.

**WARNING : THIS APPARATUS
MUST BE EARTHED.**

PRECAUTIONS

- Use only the power source specified on the unit.
- When not using this unit for a long period of time, or when cleaning it, be sure to disconnect the power plug from the AC outlet.
- Do not allow anything to rest on the power cord. And do not place this unit where people will tread on the cord. Do not overload wall outlets or power cords as this can result in a fire or electric shock.
- Avoid using this unit under the following conditions:
 - in extremely hot, cold or humid places,
 - in dusty places,
 - near appliances generating strong magnetic fields,
 - in places subject to direct sunlight,
 - in badly ventilated places,
 - in automobiles with doors closed
- Do not cover the ventilation slots while in operation as this could obstruct the required ventilation flow.
- When dust accumulates on the screen surface, clean it with a soft cloth.
- Unplug this unit from the AC outlet and refer servicing to qualified service personnel under the following conditions:
 - when the power cord is frayed or the plug is damaged,
 - if liquid has been spilled into the unit,
 - if the unit has been dropped or the cabinet has been damaged,
 - when the unit exhibits a distinct change in performance.
- Do not attempt to service this unit yourself as opening or removing covers may expose you to dangerous voltage or other hazards. Always refer servicing to qualified service personnel.
- When replacement parts are required, have the service personnel verify in writing that the replacement parts he/she uses have the same safety characteristics as the original parts. Use of manufacturer's specified replacement parts can prevent fire, shock, or other hazards.
- Upon completion of any servicing or repair work to this unit, please ask the service personnel to perform the safety check described in the manufacturer's service literature.
- When this unit reaches the end of its useful life, improper disposal could result in a picture tube implosion. Ask qualified service personnel to dispose of this unit.

SCREEN BURN

- It is not recommended to keep a certain still image displayed on screen for a long time as well as displaying extremely bright images on screen. This may cause a burning (sticking) phenomenon on the screen of cathode-ray tube. This problem does not occur as far as displaying normal video playback motion images.



POWER CONNECTION

WARNING

Do not cut off the main plug from this equipment.

If the plug fitted is not suitable for the power points in your home or the cable is too short to reach a power point, then obtain an appropriate safety approved extension lead or adapter or consult your dealer.

If nonetheless the mains plug is cut off, remove the fuse and dispose of the plug immediately, to avoid a possible shock hazard by inadvertent connection to the main supply.

If a new main plug has to be fitted, then follow the instruction given below:

WARNING:

THIS APPARATUS MUST BE EARTHED.

IMPORTANT.

The wires in the mains lead on this product are coloured in accordance with the following cord:

Green-and-yellow	: Earth
Blue	: Neutral
Brown	: Live

As these colours may not correspond with the coloured making identifying the terminals in your plug, proceed as follows:

The wire which is coloured green-and-yellow must be connected to the terminal which is marked with the letter E or the safety earth symbol (⊕) or coloured green or green-and-yellow.

The wire which is coloured blue must be connected to the terminal which is marked with the letter N or coloured black.

The wire which is coloured brown must be connected to the terminal which is marked with the letter L or coloured red.

When replacing the fuse, be sure to use only a correctly rated approved type, re-fit the fuse cover.

IF IN DOUBT — CONSULT A COMPETENT ELECTRICIAN.

How To Replace The Fuse

Open the fuse compartment with the blade screwdriver, and replace the fuse.

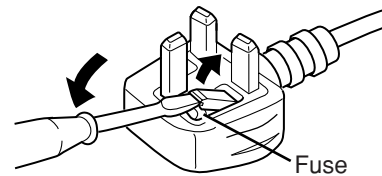

CONTENTS

SAFETY PRECAUTIONS	2
CONTROLS AND FEATURES	4
HOW TO HANDLE BASIC OPERATIONS	6
HOW TO USE THE MENU FUNCTIONS	7
HOW TO INITIALISE THE SETTING	10
BASIC CONNECTION EXAMPLE	11
TROUBLESHOOTING	13
SPECIFICATIONS	14

CONTROLS AND FEATURES

FRONT VIEW

<Front Panel>

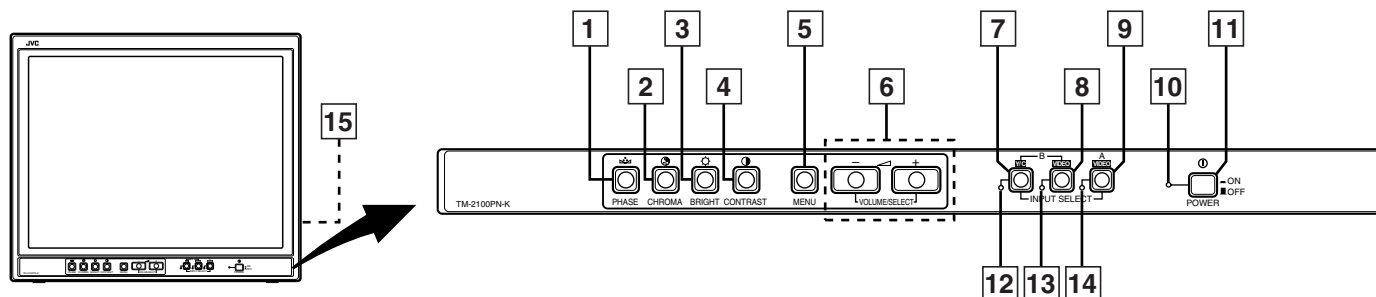

1 Phase button [PHASE]

Press this button to set the picture hue adjustment mode. Adjust the value with the VOLUME/SELECT buttons. Also used as a control button in the menu function mode.

2 Chroma button [CHROMA]

Press this button to set the picture colour density adjustment mode. Adjust the value with the VOLUME/SELECT buttons. Also used as a control button in the menu function mode.

3 Brightness button [BRIGHT]

Press this button to adjust picture brightness. Adjust the value with the VOLUME/SELECT buttons. Also used as a control button in the menu function mode.

4 Contrast button [CONTRAST]

Press this button to adjust picture contrast. Adjust the value with the VOLUME/SELECT buttons. Also used as a control button in the menu function mode.

5 Menu button [MENU]

Displays and exits the <MENU> screen. Pressing the PHASE button with the Menu button depressed will display the <SET-UP MENU> screen.

6 Volume/Select buttons [VOLUME/SELECT - +]

Adjusts the speaker volume. Also used as a control button in the menu function mode.

7 Input B (Y/C) button [INPUT SELECT B]

Selects the video signal input to the VIDEO B (Y/C) terminal (mini DIN 4 pin connector) and the audio signal input to the AUDIO B terminal (RCA connector) on the rear panel. When selected, the input B (Y/C) indicator  lights.

8 Input B (VIDEO) button [INPUT SELECT B]

Selects the video signal input to the VIDEO B terminal (BNC connector) and the audio signal input to the AUDIO B terminal (RCA connector) on the rear panel. When selected, the input B (VIDEO) indicator  lights.

9 Input A (VIDEO) button [INPUT SELECT A]

Selects the video signal input to the VIDEO A terminal (BNC connector) and the audio signal input to the AUDIO A terminal (RCA connector) on the rear panel. When selected, the input A (VIDEO) indicator  lights.

10 Power indicator

Lights in green when the power is ON.

Lit : When the power is on.

Unlit : When the power is off.

11 Power switch [POWER]

Press this switch to turn the power on or off.

ON : Power is turned on.

OFF : Power is turned off.

12 Input B (Y/C) indicator

Lights in green when the Input B (Y/C) is selected.

13 Input B (VIDEO) indicator

Lights in green when the Input B (VIDEO) is selected.

14 Input A (VIDEO) indicator

Lights in green when the Input A (VIDEO) is selected.

15 Speaker

A built-in speaker is located inside the right side panel when the monitor is viewed from the front.



REAR VIEW

<Rear Panel>

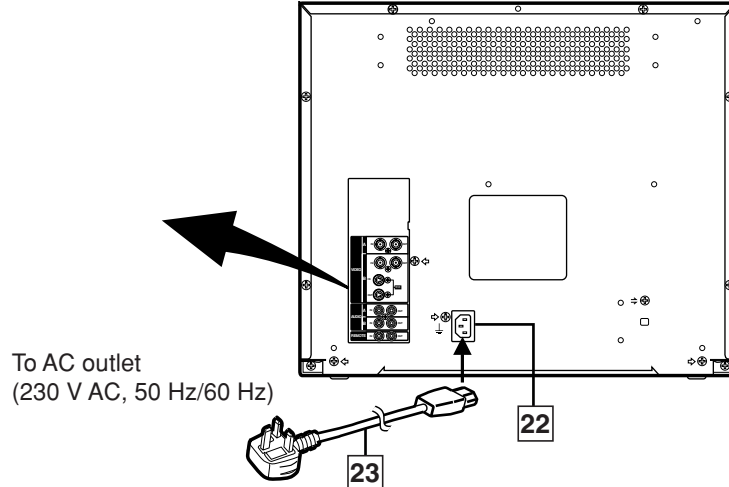
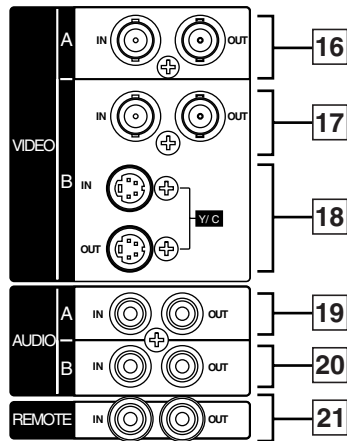

16 Video A terminals [VIDEO A IN/OUT]

Video signal input (IN) and output (OUT) terminals. The output terminal is bridge-connected.

IN : Video signal input terminal

OUT : Bridge-connected video signal output terminal

Notes:

- * For corresponding audio signals, use the AUDIO A terminals [19].
- * Also refer to the BASIC CONNECTION EXAMPLE on pages 11 and 12.

17 Video B terminals [VIDEO B IN/OUT]

Video signal input (IN) and output (OUT) terminals. The output terminal is bridge-connected.

IN : Video signal input terminal

OUT : Bridge-connected video signal output terminal

Notes:

- * For corresponding audio signals, use the AUDIO B terminals [20].
- * Also refer to the BASIC CONNECTION EXAMPLE on pages 11 and 12.

18 Video B (Y/C) terminals [VIDEO B Y/C IN/OUT]

Y/C (S-Video) signal input (IN) and output (OUT) terminals. The output terminal is bridge-connected.

IN : Y/C-separated (S-video) signal input terminal

OUT : Bridge-connected Y/C-separated (S-video) signal output terminal

Notes:

- * For corresponding audio signals, use the AUDIO B terminals [20].
- * Also refer to the BASIC CONNECTION EXAMPLE on pages 11 and 12.

19 Audio A terminal [AUDIO A IN/OUT]

Input (IN) and output (OUT) terminals for the audio signal corresponding the VIDEO A terminals [16]. The output terminal is bridge-connected.

IN : Audio signal input terminal

OUT : Bridge-connected audio signal output terminal

Notes:

- * For corresponding video signals, use the VIDEO A terminal [16].
- * Also refer to the BASIC CONNECTION EXAMPLE on pages 11 and 12.

20 Audio B terminals [AUDIO B IN/OUT]

Input (IN) and output (OUT) terminals for the audio signals corresponding to the VIDEO B terminals [17] or VIDEO B (Y/C) terminals [18]. The output terminal is bridge-connected.

IN : Audio signal input terminal

OUT : Bridge-connected audio signal output terminal

Notes:

- * For corresponding video signals, use the VIDEO B terminals [17] or VIDEO B (Y/C) terminals [18].
- * Also refer to the BASIC CONNECTION EXAMPLE on pages 11 and 12.

21 Remote terminals [REMOTE IN/OUT]

Input (IN) and output (OUT) terminals for external control. The output terminal is bridge-connected. External control is available either to select the ASPECT RATIO or to select ON or OFF in BRIGHTNESS P.S. function mode. Set the external control in the <SET-UP MENU> screen mode.

External control functions	External control switch	
	Open circuit (open)	Short circuit (short)
ASPECT RATIO	4-3 (4:3)	16-9 (16:9)
BRIGHTNESS P.S.	OFF	ON

Note:

- * Also refer to the BASIC CONNECTION EXAMPLE on pages 11 and 12.

22 AC Inlet [AC IN]

Power input connector. Connect the provided AC power cord [21] to an AC outlet (230 V AC, 50 Hz/60 Hz).

23 Power cord

Connects the provided power cord (230 V AC, 50 Hz/60 Hz) to the AC IN connector.



HOW TO HANDLE BASIC OPERATIONS

BASIC OPERATION

1. Press the **POWER** switch to turn on the power.

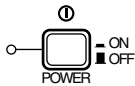

ON : Power turns ON. (Power indicator: lit)
OFF : Power turns OFF. (Power indicator: unlit)

2. Press the **INPUT SELECT** button to choose input.

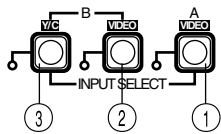

Selects video/audio signals input to terminals on the rear panel.

INPUT SELECT button	Terminals on the rear panel	
	Video signal input	Audio signal input
① Input A (VIDEO)	VIDEO A terminal	AUDIO A terminal
② Input B (VIDEO)	VIDEO B terminal	AUDIO B terminal
③ Input B (Y/C)	VIDEO B (Y/C) terminal	

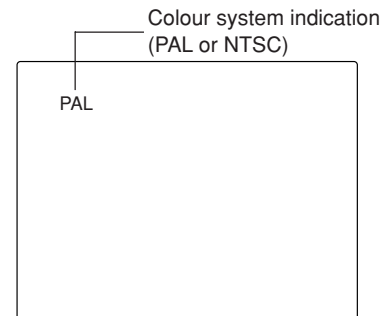

With regard to Colour system indication

- With the COLOR SYSTEM setting set to AUTO mode, when you turn on the power or select inputs, the colour system indication appears for about 3 seconds on the screen while PAL or NTSC signals are being detected. It does not appear when receiving B/W signal or when no signal is input. See page 7 for COLOR SYSTEM setting.

3. Press the **VOLUME/SELECT** buttons to adjust the speaker volume.



Press this button to display the speaker volume level on the screen.

+ : The Built-in speaker volume is increased. (00 → 50)

- : The Built-in speaker volume is decreased. (50 → 00)

* Screen indication will disappear about 10 seconds after operating.

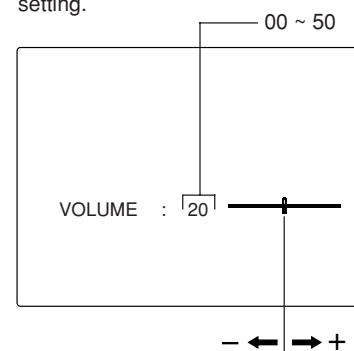

PICTURE ADJUSTMENT

1. Press select button corresponding to the item you want to adjust.

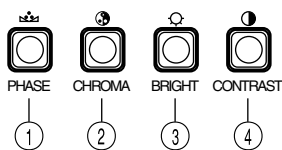

The item you select is displayed on the screen.

- ① PHASE (☉) : Phase control
- ② CHROMA (⊕) : Chroma control
- ③ BRIGHT (☀) : Brightness control
- ④ CONTRAST (●) : Contrast control

2. Adjust with the **VOLUME/SELECT** buttons.



Items	VOLUME/SELECT button	
	-	+
PHASE (Phase)	reddish	greenish
CHROMA (Chroma)	lighter	deeper
BRIGHT (Brightness)	darker	brighter
CONTRAST (Contrast)	lower	higher

* Screen indication will disappear about 10 seconds after operating.

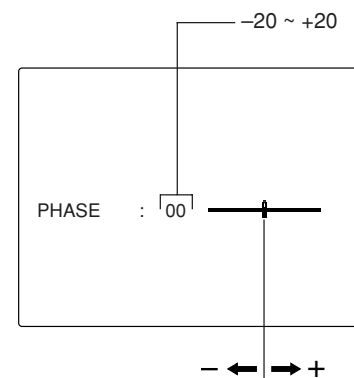

Notes:

- Phase control is effective only in the NTSC colour system mode.
- Chroma control is not effective when receiving B/W or when no signal is input.
- When the Chroma control is set to level “-20”, the picture turns monochrome.
- “NO EFFECT” is displayed (For about 3 seconds) when your selected function has no effect.



HOW TO USE THE MENU FUNCTIONS

DISPLAY AND SELECTION IN THE <MENU> SCREEN MODE (SETTING)

You can set the following menu items.
Set them depending on your needs.

- SHARPNESS
- COLOR TEMP.
- COLOR SYSTEM
- ASPECT RATIO
- BRIGHTNESS P.S.

1. Press the MENU button.



The <MENU> screen is displayed.

2. Press the PHASE () or CHROMA () button to select MENU items.



A selection mark (▶) is put next to the selected item.

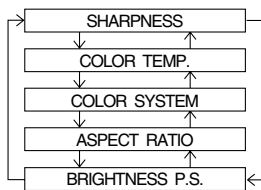

Front panel button	Function displayed	Contents
PHASE ()	▼	Forwards selection mark (▶)
CHROMA ()	▲	Reverses selection mark (▶)

3. Press the VOLUME/SELECT buttons to set.



Front panel button	Function displayed	Contents
VOLUME/SELECT (+)	+	Increases (to max. value)
	▶	Forwards the setting value
VOLUME/SELECT (-)	-	Decreases (to min. value)
	◀	Reverses the setting value

Menu items	Purpose	Setting range
SHARPNESS	Picture sharpness	00 ↔ +1 ↔ +2 ↔ +3 ↔ +4 ↔ +5
COLOR TEMP.	Colour temperature of white balance	6500 ↔ 9300
COLOR SYSTEM	Colour system	AUTO ↔ NTSC ↔ AUTO ↔ PAL
ASPECT RATIO	Aspect ratio	4 - 3 ↔ 16 - 9
BRIGHTNESS P.S.	Brightness Peak Suppressor function	OFF ↔ ON

* Normally set the COLOR SYSTEM to the AUTO mode. If reception in the AUTO mode is not good, set it to the exclusive mode (NTSC or PAL) corresponding to the received colour system.

4. If you want to set the other menu items, repeat procedures 2 and 3.

5. Press the MENU button to quit.



Front panel button	Function displayed	Contents
MENU	EXIT	Quits (or Releases) the <MENU> screen

<MENU> screen

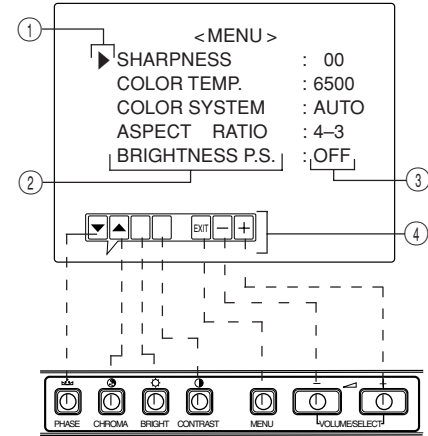

<Front panel button>

- ① Selection mark (▶): Indicates the menu item you select.
- ② Menu item: Menu items you can select.
- ③ Setting display: Indicates the current settings (value).
- ④ Function display: The functions of the front panel buttons (7 buttons on the left.) correspond to the function displayed.

Function displayed	Contents
▼	Forwards the menu item
▲	Reverses the menu item
-	Lowers the adjustment value (to the minimum)
+	Raises the adjustment value (to the maximum)
▶	Forwards the setting value
◀	Reverses the setting value
EXIT	Exits the <MENU> screen

Notes:

- BRIGHTNESS P.S. (or B.P.S.) stands for Brightness Peak Suppressor. This function is used to suppress (cut) the white peak portion of the picture, so as to reduce the picture's burning on the screen (cathode ray tube).
- When the BRIGHTNESS P.S. (or B.P.S.) function is ON, the suppressed white peak portion (for example, the lit part of a fluorescent lamp) seems to be blurred. If required, lower the setting for the B.P.S. LEVEL in the <SET-UP MENU> screen mode, or turn off the BRIGHTNESS P.S. function.
- When the screen aspect ratio is set to 16-9 (16:9) the picture will be vertically reduced.
- If REMOTE is displayed in the ASPECT RATIO or BRIGHTNESS P.S. setting values in the <MENU> screen, REMOTE SELECT is set to "ASPT" or "B.P.S." in the <SET-UP MENU> screen. In this case, it is not possible to adjust the setting ranges for ASPECT RATIO and BRIGHTNESS P.S. If you need to make adjustments, use the external control function or turn off the REMOTE SELECT setting.



HOW TO USE THE MENU FUNCTIONS (cont'd)

DISPLAY AND SELECTIONS IN THE <SET-UP MENU> MODE (SETTING)

You can set the following set-up menu items.

- H. POSITION
- V. POSITION
- WHITE BALANCE
- CONTROL LOCK
- B.P.S. LEVEL
- REMOTE SELECT

Notes:

- Parameters for H. POSITION and V. POSITION can be set separately depending on the video input (Input A (VIDEO), Input B (VIDEO) or Input B (Y/C)) selected by the input select buttons on the front panel.
Select the required video input with the input select buttons on the front panel in advance.
- WHITE BALANCE can be set individually at 6500 or 9300 for the colour temperature value.
Set COLOR TEMP. to the value 6500 or 9300 in the <MENU> screen in advance.

1. While pressing the MENU button, press the PHASE () button.

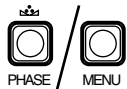

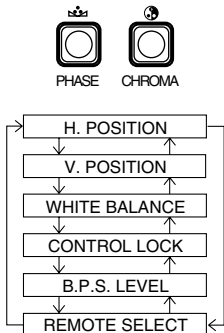

The <SET-UP MENU> screen is displayed.

2. Press the PHASE () or CHROMA () button to select the desired menu item.



A selection mark (▶) is put next to the selected item.

Front panel button	Function displayed	Contents
PHASE ()	▼	Forwards selection mark (▶)
CHROMA ()	▲	Reverses selection mark (▶)

3. Press the VOLUME/SELECT buttons to set.



Front panel button	Function displayed	Contents
VOLUME/SELECT (+)	+	Increases (to max. value)
	▶	Forwards the setting value
VOLUME/SELECT (-)	CUTO	Selects CUT OFF setting screen
	-	Decreases (to min. value)
	◀	Reverses the setting value
	DRV	Selects DRIVE setting screen

Note:

- For the WHITE BALANCE setting, select the CUT OFF or DRIVE setting screen, then select the buttons (PHASE/CHROMA/BRIGHT) corresponding to the function indicated (R/G/B).

<SET-UP MENU> screen

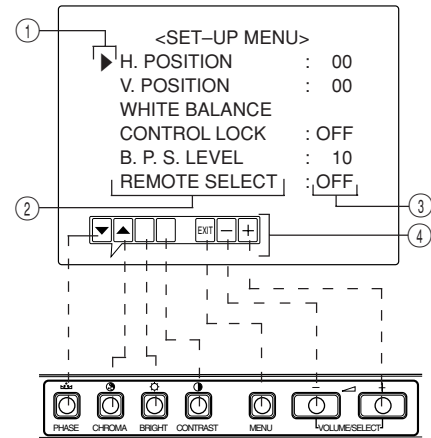

<Front panel button>

- ① **Selection mark (▶):** Indicates the menu item you select.
- ② **Menu item:** Menu items you can select.
- ③ **Setting display:** Indicates the current settings (value).
- ④ **Function display:** The functions of the front panel buttons (7 buttons on the left.) correspond to the function displayed.

Function displayed	Contents
▼	Forwards the menu item
▲	Reverses the menu item
-	Lowers the adjustment value (to the minimum)
+	Raises the adjustment value (to the maximum)
▶	Forwards the setting value
◀	Reverses the setting value
EXIT	Exits the <SET-UP MENU> screen (release)
DRV	Selects DRV adjustment
CUTO	Selects CUT OFF adjustment
R	Adjusts red signal level
G	Adjusts green signal level
B	Adjusts blue signal level
DISP	Turns the ON-SCREEN display on or off. (This function is effective only in the DRIVE or CUT OFF adjustment mode.)



HOW TO INITIALISE THE SETTING

SCREEN DISPLAY AND SELECTIONS IN THE <SET-UP MENU> RESET MODE

You can set <MENU> and <SET-UP MENU> screen items, picture adjustment items and the volume level to their factory-set (initial) values.

1. Press the Power (ⓐ) Switch to turn the power OFF (■).



2. While pressing both MENU button and PHASE (ⓑ) button, press the Power (ⓐ) switch to turn the power ON (■).



The <SET-UP MENU> RESET screen is displayed.

Note:

- The <SET-UP MENU> PRESET screen will not be displayed if the MENU or PHASE buttons are pressed for a very short time. Keep pressing them until the display screen appears.

3. Setting

● Initialisation is required.



Press the CONTRAST (ⓑ) button.
* Initialisation is completed, and the <SET-UP MENU> RESET screen disappears.

● Initialisation is not required.



Press the VOLUME/SELECT [+] or [-] button.
* Initialisation is aborted, and the <SET-UP MENU> RESET screen disappears.

<SET-UP MENU> RESET screen

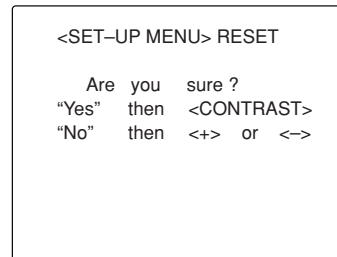

Initial settings

Sorts	Functions (Items)	Initialisation (setting)
<MENU> screen	SHARPNESS	00
	COLOR TEMP.	6500
	COLOR SYSTEM	AUTO
	ASPECT RATIO	4-3
	BRIGHTNESS P.S.	OFF
<SET-UP MENU> screen	H. POSITION	00
	V. POSITION	00
	WHITE BALANCE	
	R. CUT OFF	00
	G. CUT OFF	00
	B. CUT OFF	00
	R. DRIVE	00
	G. DRIVE	00
	B. DRIVE	00
	CONTROL LOCK	OFF
B.P.S. LEVEL	10	
REMOTE SELECT	OFF	
Picture adjustment	PHASE	00
	CHROMA	00
	CONTRAST	00
	BRIGHT	00
Volume	VOLUME	20

BASIC CONNECTION EXAMPLE

Notes:

- * Before connecting your system, make sure that all units are turned off.
- * The illustration below shows some examples of different connections. Terminal connections may differ depending on the component connected. Be sure to refer to the instructions provided with the unit(s) you are connecting.
- * Each pair of input (IN) and output (OUT) terminals are bridge-connected.
- * If you're not connecting any equipment to a bridged output (OUT) terminal, be sure not to connect any other cables to the bridged output (OUT) terminal as this will cause the terminating resistance switch to open (auto terminate function).
- * When making a bridge connection, connect the input (IN) and output (OUT) terminals on the monitor to separate video components.
(For example, if both terminals are connected to the same VCR, resonance may occur except during playback. This is caused by the same video signal "looping" between the VCRs, and is not a malfunction.)
- * Select the video input (Input A (VIDEO), Input B (Y/C) or Input B (VIDEO)) with the INPUT SELECT button on the front panel.
- * The ASPECT RATIO or BRIGHTNESS P.S. function can be controlled via the REMOTE terminal. To do this, set REMOTE SELECT in the <SET-UP MENU> mode. (Refer to pages 8 and 9.)

VIDEO A Connection Example (Select Input A (VIDEO) button)

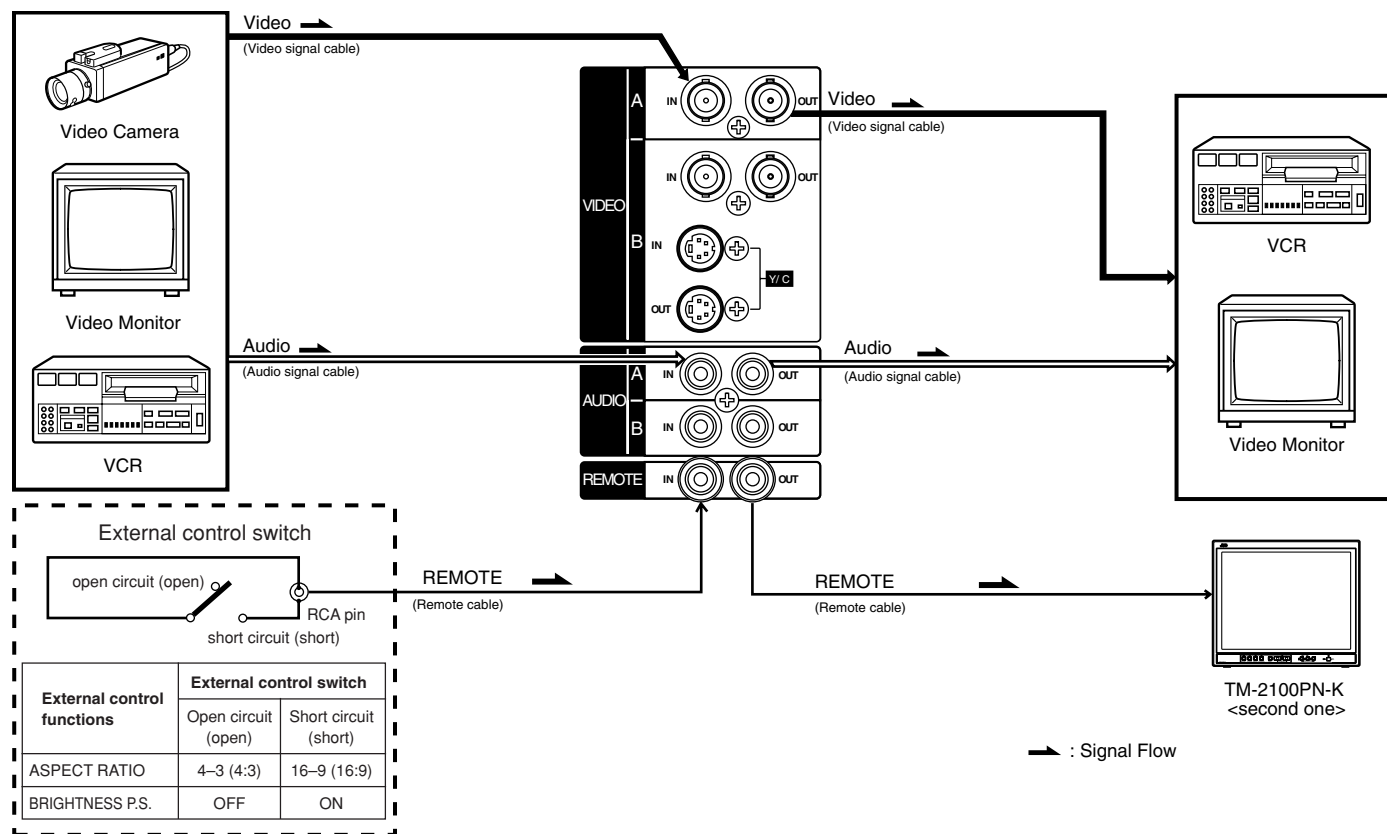



BASIC CONNECTION EXAMPLE (cont'd)

VIDEO B (VIDEO) Connection Example (Select Input B (VIDEO) button)

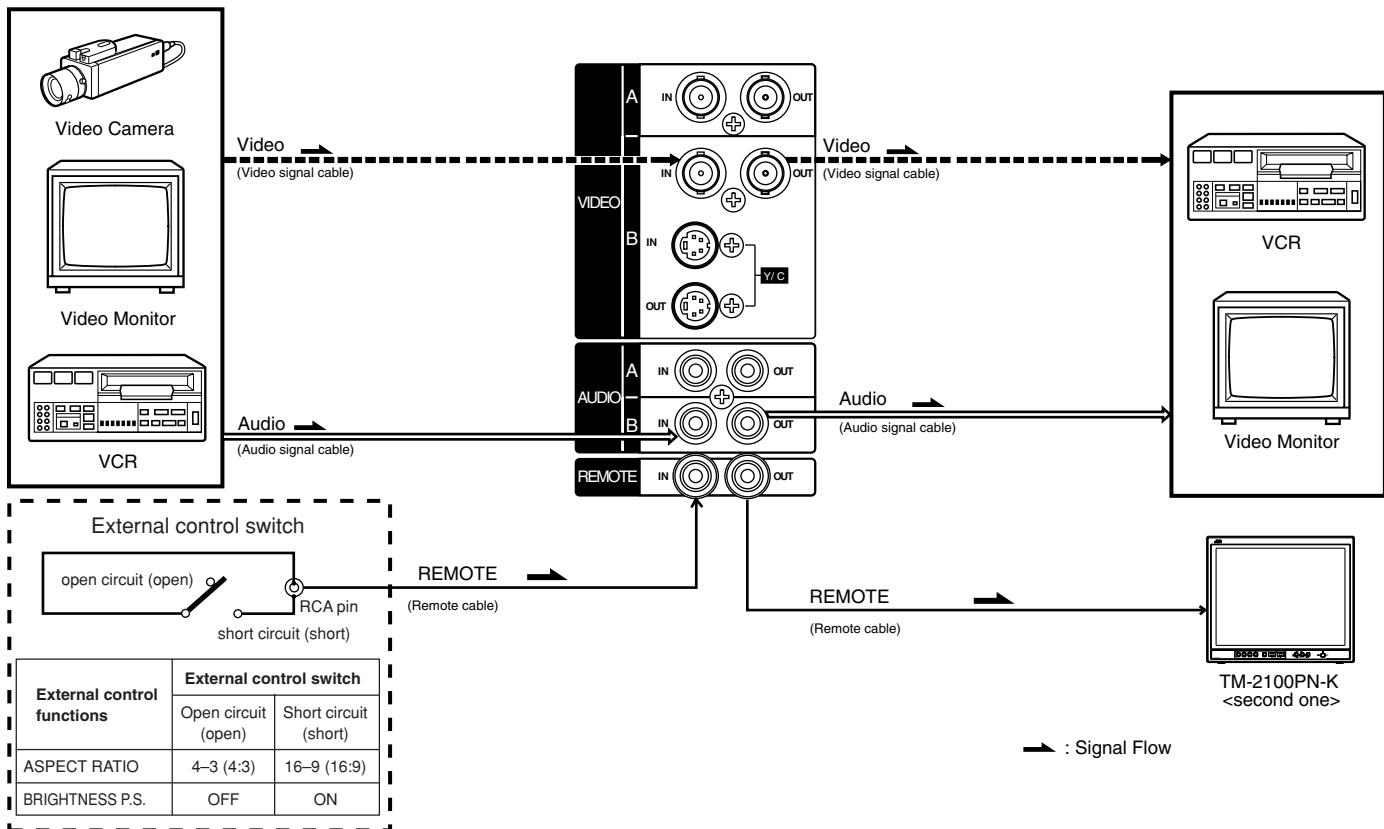

VIDEO B (Y/C) Connection Example (Select Input B (Y/C) button)

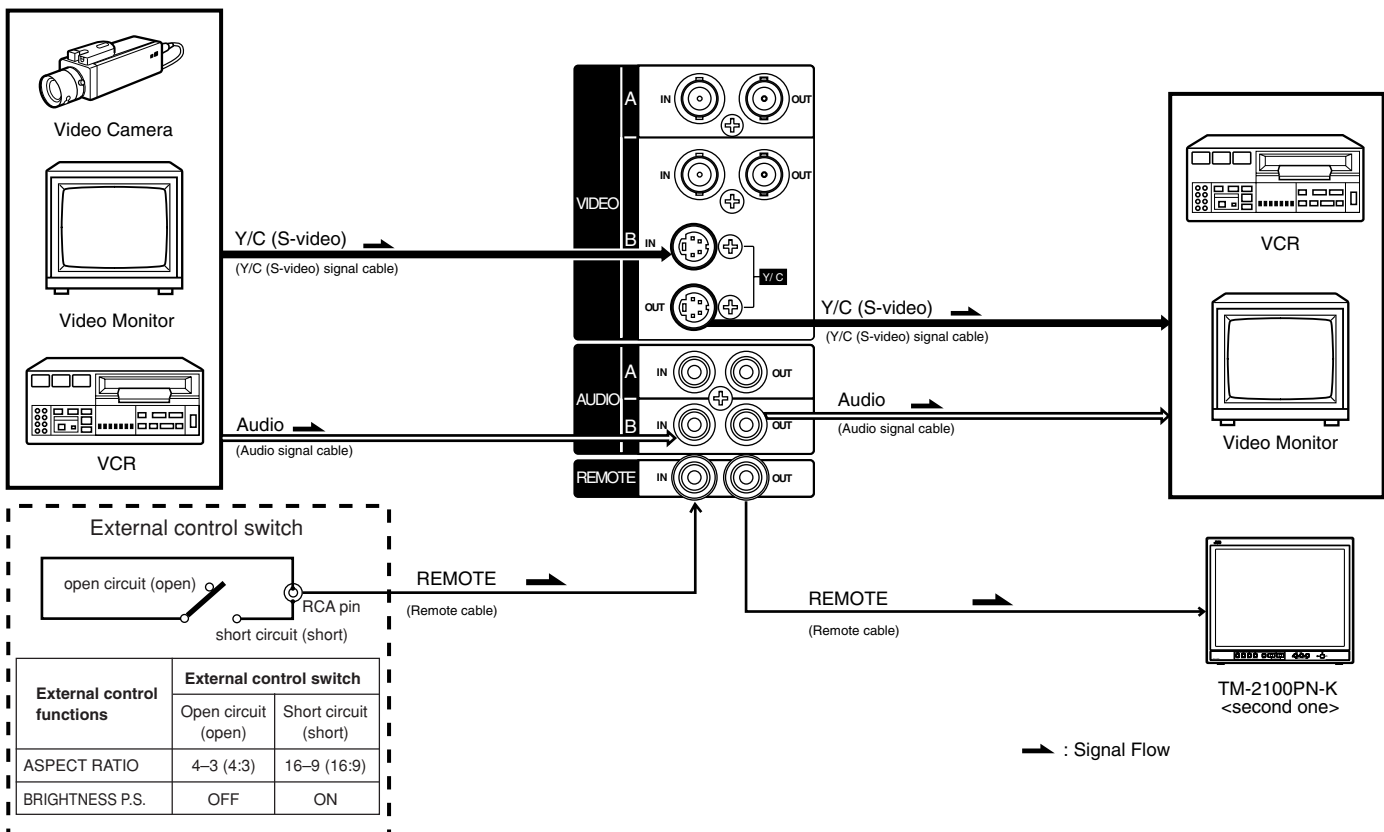



TROUBLESHOOTING

Solutions to common problems related to your monitor are described here. If none of the solutions presented here solves the problem, unplug the monitor and consult a JVC-authorized dealer or service centre for assistance.

Problems	Points to be checked	Measures (Remedy)
No power supply.	Is the power plug loosened or disconnected?	Firmly insert the power plug.
No picture with the power on.	Is the video signal output from the connected component?	Set the connected component correctly.
	Is the input signal selected properly?	Select the required video signal input with the Input select button. (See page 6.)
	Is the video cable disconnected?	Connect the video signal cable firmly. (See pages 11 and 12.)
No sound.	Is the audio signal output from the connected component?	Set the connected component correctly.
	Is the volume output set to minimum?	Adjust the speaker volume with the VOLUME/ SELECT buttons. (See page 6.)
	Is the audio cable disconnected?	Connect the audio signal cable firmly. (See pages 11 and 12.)
Shaking picture.	Is the monitor close to a device generating a strong magnetic field?	Move the device away from the monitor until the picture stabilises.
No colours, wrong colour, or dark picture.	Is the colour system selected properly?	Set the COLOR SYSTEM in the <MENU> screen mode to [AUTO] mode. (See page 7.)
	Has the picture control setting (CONTRAST, BRIGHT, CHROMA or PHASE) been changed?	Set each picture control to the standard setting. (See page 6.)
Unnatural, irregularly coloured, or distorted picture.	Is the monitor close to a speaker, magnet or any other device generating a strong magnetic field?	Move the device away from the monitor and turn the monitor's power off. Wait at least 30 minutes, then turn the power on again.
Dark stripes appear at the top and bottom of the screen, picture vertically squeezed.	Is the aspect ratio set to 16:9?	Set the ASPECT RATIO in the <MENU> screen mode to [4 : 3 (4 - 3)] (See page 7.) When controlling externally, ASPECT RATIO should be set to [4 : 3 (4-3)]. (See pages 11 and 12.)
White peak portion of the picture (for example, the lit part of a fluorescent lamp) is dark, unclear, and the colour is blurred.	Is the BRIGHTNESS P.S. function set to ON?	Set the BRIGHTNESS P.S. function in the <MENU> screen mode to OFF. (See page 7.) When controlling externally, BRIGHTNESS P.S. function should be set to OFF. (See pages 11 and 12.)
Front panel button does not function.	Are the operation buttons on the front panel locked? (Has CONTROL LOCK function set to ON?)	Set the CONTROL LOCK to OFF in the <SET-UP MENU> screen mode. (See pages 8 and 9.)

The following are not malfunctions:

- When a bright still image (such as a white cloth) is displayed for a long period, it may appear to be coloured. This is due to the structure of the cathode ray tube and will be deleted when another image is displayed.
- You experience a mild electric shock when you touch the picture tube. This phenomenon is due to a normal buildup of static electricity on the CRT and is not harmful.
- The monitor emits a strange sound when the room temperature changes suddenly. This is only a problem if an abnormality appears on the screen as well.



SPECIFICATIONS

MODEL		TM-2100PN-K
Type		Colour video monitor
Colour system		PAL, NTSC (3.58)
Picture tube		54 cm measured diagonally, flat-square type, 90° deflection, in-line gun, vertical line trio type (phosphor stripe pitch 0.69 mm)
Effective screen size		Width 406.4 mm Height 304.8 mm Diagonal 508 mm
Scanning frequency		H : 15.734 kHz (NTSC), 15.625 kHz (PAL) V : 59.94 Hz (NTSC), 50 Hz (PAL)
Horizontal resolution		450 TV lines or more (Y/C input mode)
Input terminals	VIDEO A	Composite video: 1 line, BNC connector x 2, 1 V(p-p), 75 Ω negative sync (bridge connection possible, auto termination)
	VIDEO B	Composite video: 1 line, BNC connector x 2, 1 V(p-p), 75 Ω negative sync (bridge connection possible, auto termination)
		Y/C-separated: 1 line, mini-DIN 4-pin connector x 2 Y: 1.0 V(p-p), 75 Ω C: 0.286 V(p-p), 75 Ω (NTSC), 0.3 V(p-p), 75 Ω (PAL) (bridge connection possible, auto termination)
	AUDIO A	1 line (monaural), RCA pin x 2, 0.5 V(rms), high-impedance (bridge connection possible)
	AUDIO B	1 line (monaural), RCA pin x 2, 0.5 V(rms), high-impedance (bridge connection possible)
	REMOTE	1 line, RCA pin x 2 (bridge connection possible)
Audio power output		1 W (monaural)
Built-in speaker		8 cm round x 1, impedance of 8 Ω
Environmental conditions		Operation temperature: 0 – 40 °C Operation humidity: 20 – 80% (non-condensing)
Power requirements		230 V AC, 50 Hz/ 60 Hz
Power consumption		0.72A (230 V AC)
Dimensions		Width 476 mm Height 407.5 mm Depth 492 mm
Weight		28.5 kg
Accessory		AC power cord (2 m) x 1

* Illustrations used in this manual are for explanatory purposes only. The appearance of the actual product may differ slightly.

* Dimensions and weight are approximate.

* E. & O. E. Design and specifications subject to change without notice.



■ Dimensions

Unit : mm

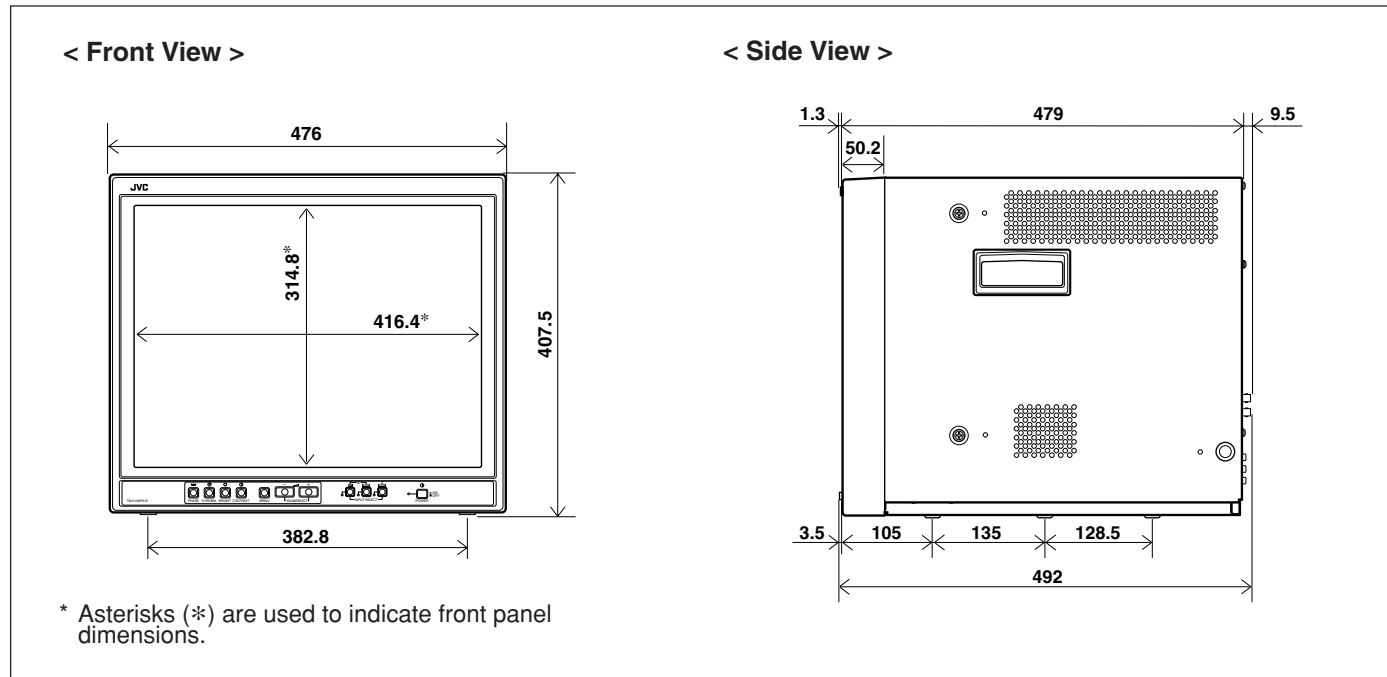

■ Y/C (Mini DIN 4 pin) terminal specification

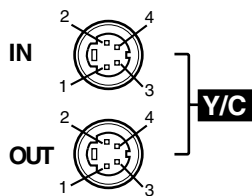

Pin No.	Signal
1	GND (Y)
2	GND (C)
3	Y
4	C





TM-2100PN-K COLOUR VIDEO MONITOR



JVC
VICTOR COMPANY OF JAPAN, LIMITED

© 2002 VICTOR COMPANY OF JAPAN, LIMITED

 Printed in Thailand
0702-Y-U-JMT

