

Cooker

BK 6340 Y

BEKO

Please read this first!

Dear Customer,

With this unit you have chosen a device of advanced technology and top quality.

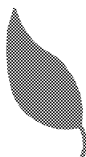

The unit was produced in modern enterprises corresponding to environmental standards.

This manual is part of the equipment. The instructions will help you to operate the unit quickly and safely.

- Upon delivery, please check that the unit is not damaged. If you note any transport damage, please contact immediately your point of sale and do not take the unit into operation!
- Before you connect and start using the unit, please read this manual and all enclosed documents. Please note in particular the safety instructions.
- Keep all documents so that you can refer to the information again later on. Please keep your receipt for any possible cases of warranty.
- When you pass on the unit to another person, please provide all documents with it.

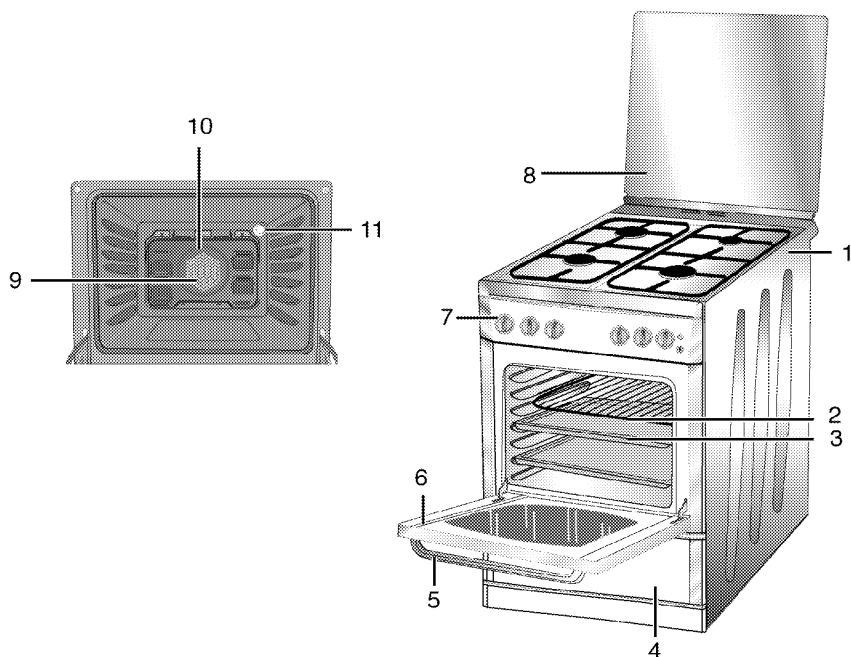

Table of Contents

1 GENERAL INFORMATION	4	First cleaning of the product	14
Overview	4	Initial heating	14
Technical Data	5	4 HOW TO USE THE HOB	15
Accessories supplied with the unit	6	General information on cooking	15
2 SAFETY INSTRUCTIONS	7	How to use hobs	15
Explanation of safety instructions	7	5 HOW TO OPERATE THE OVEN 16	
Basic safety instructions	7	General information on baking, roasting and grilling	16
Safety for child	8	How to use the electric oven	16
Safety when working with gas	8	Operating modes	16
Safety when working with electricity	9	Cooking times table	17
Intended use	9	6 MAINTENANCE AND CARE	18
Tips for saving energy	9	General information	18
Disposal	10	How to clean the hob	18
Packaging material	10	Cleaning the control panel	18
Old equipment	10	Cleaning the oven	18
Future transportation	10	Exchange oven lamp	19
3 INSTALLATION	11	Troubleshooting	19
Preparations	11		
Installation and connection	11		
Initial operation	14		

1 GENERAL INFORMATION

Overview



- | | | | |
|---|----------------|----|--------------------------------|
| 1 | Burners' plate | 7 | Control panel |
| 2 | Wire shelf | 8 | Top lid |
| 3 | Tray | 9 | Fan motor (behind steel plate) |
| 4 | Bottom part | 10 | Ring heater |
| 5 | Handle | 11 | Lamp |
| 6 | Front door | | |

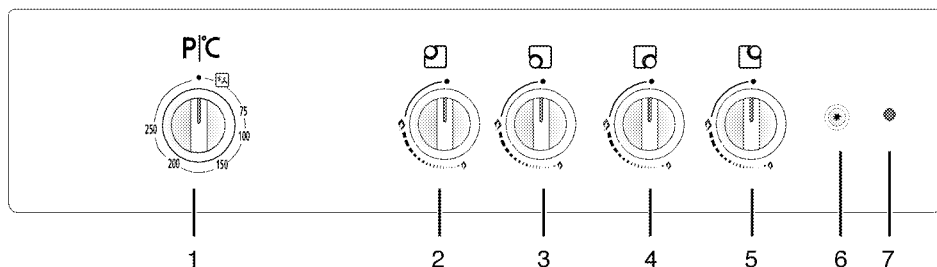

- | | | | |
|---|--------------------------|---|-----------------------------|
| 1 | Function knob | 5 | Auxiliary burner Rear right |
| 2 | Normal burner Rear left | 6 | Ignition button |
| 3 | Normal burner Front left | 7 | Thermostat lamp |
| 4 | Rapid burner Front right | | |

Technical Data

GENERAL	
Outer dimensions (height/width/depth)	850 mm/600 mm/600 mm
Voltage/frequency	220 V ~ 50 Hz
Total electric consumption	2.2 kW
Fuse protection	min. 16 A
Cable type / cross section	H05VV-FG 3 x 1 mm ²
Cable length	max. 2 m
Gas device category	II _{2H 3B/P}
Gas type/pressure	LPG G 30/28-30 mbar
Total gas consumption	7.9 kW
Conversion to gas type/pressure [§]	NG G 20/20 mbar
HOB	
Burners	
Rear left	Normal burner
Power	2000 W
Front left	Normal burner
Power	2000 W
Front right	Rapid burner
Power	2900 W
Rear right	Auxiliary burner
Power	1000 W
OVEN/GRILL	
Main oven	Fan oven
Energy efficiency class [#]	C
Inside illumination	15–25 W

[#] Basis: In electrical ovens, the data on energy labels are in conformity with EN 50304. Values were determined under standard load and convection/hot air (if available). Heating mode with an energy efficiency rating specified by EN 50304 is determined in accordance with below priority order depending on functions (modes) availability on the product. 1- Eco fan heating, 2-Slow cooking, 3-Fan heating (hot air), 4-Top and bottom heat with convection air, 5-Top and bottom heating.

Accessories supplied with the unit

Baking tray

Can be used for pastries, frozen foods and big roasts.

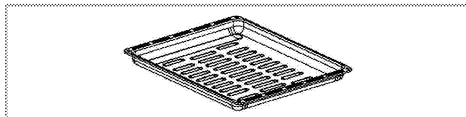

Deep roasting tray

Can be used for pastries, big roasts, foods with liquid content and during grilling as dripping pan.

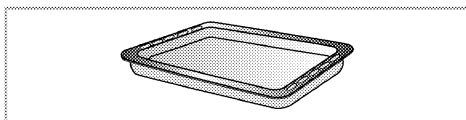

Wire shelf

Can be used for roasting and as deposit for baking, roasting and casserole dishes.

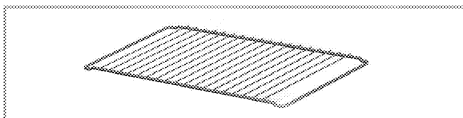

Coffee pot adaptor

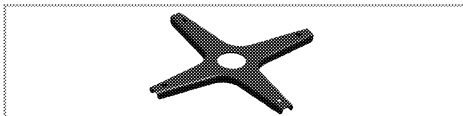

Can be used for a coffee pot.

2 SAFETY INSTRUCTIONS

Explanation of safety instructions

The following types of safety instructions and information are used in this manual. They can be distinguished by the symbol and the initial signal word.



DANGER

High risk of personal injury.

Non-observance may or will cause serious injuries or death.



CAUTION

Risk of personal injury.

Non-observance may or will cause minor or medium injuries.



NOTICE

Risk of material damage.

Non-observance may or will cause damage on the unit or other objects.



Important

Tip for the user.

Useful information on how to use the unit. No injury risk information.

Basic safety instructions

- Manufacturer reserves its right to make changes in the technical specifications in order to improve the product quality without any prior notice. Figures included in this manual are for schematic purpose only and may not match exactly with your product. Values stated on the markings of the product or in other printed documents supplied with the

product are obtained under laboratory conditions as per relevant standards. These values may vary according to the usage of the product and ambient conditions.

- This appliance is not intended for use by persons (including children) with reduced physical, sensory or mental capabilities, or lack of experience and knowledge, unless they have been given supervision or instruction concerning use of appliance by a person responsible for their safety.

Children should be supervised to ensure that they do not play with the appliance.

- Do not take the unit into operation if it is defective or shows any visible damage.
- Do not carry out any repairs or modifications on the unit. However, you may remedy some malfunctions; see *Troubleshooting*, page 19.
- Be careful when using alcoholic drinks in your dishes. Alcohol evaporates in high temperatures and may cause fire since it will catch fire when it gets in contact with hot surfaces.
- Do not heat the closed food containers and glass jars. Pressure that may build-up in the jar can cause it to burst.
- Ensure that no flammable materials are adjacent to the product as the sides become hot during use.
- Do not leave empty pots or pans on plates that are switched on. They might get damaged.
- Since it may be hot, do not leave plastic or aluminum dishes on the

surface of appliance. These kind of dishes should not be used to keep food either.

- Do not close the lid before the hob has cooled down sufficiently.

In order to avoid any spillage from leaking down the back or into the oven, you must wipe the surface of the the lid before opening upright.

- Do not place baking trays, dishes or aluminium foil directly onto the bottom of the oven. The heat accumulation might damage the bottom of the oven.
- Product may be hot when it is in use. Never touch the hot burners, inner sections of the oven, heating elements and etc. Keep children away!
- Always use heat-resistant gloves when putting or removing the dishes into/from your oven.
- Rear surface of the oven gets hot when it is in use. Gas / Electric connection should not contact to the rear surface, otherwise connections may get damaged. Do not squeeze the connection cables between the hot oven door and frame. Do not route the connection cables over the hot cooking section. Otherwise, cable insulation may melt and cause fire as a result of short circuit.
- Check all controls on the appliances are switched off after use.



Important

Call the authorised service for installation of the appliance to be used. After this procedure, guarantee period will be started.

Safety for child

- Accessible parts of the appliance will become hot whilst the appliance is in

use and until the appliance has cooled, children should be kept away.

- Do not store any items above the appliance that children may reach.
- The packaging materials will be dangerous for children. Kept away the packaging materials from children. Please dispose of all parts of the packaging according to environmental standards.
- When the door is open, do **not** load any heavy object on it and do **not** allow children sitting on. It may cause overturning or door hinges might get damaged.

Safety when working with gas

- Any works on gas equipment and systems may only be carried out by authorised qualified persons.
- Prior the installation, be sure that the conditions of local distribution (gas type and gas pressure) and the adjustment of the appliance are compatible.
- This appliance is not connected to a combustion products evacuation device. It shall be installed and connected in accordance with current installation regulations. Particular attention shall be given to the relevant requirements regarding ventilation; See *Preparations, page 11*
- The use of a gas-cooking appliance produces heat and humidity in the space where it is located. You should assure a good ventilation of the kitchen: keep open the natural ventilation exits, or install a mechanic ventilation device (hood).
- Gas appliances and systems must be regularly checked for proper

functioning. Please arrange for annual maintenance.

- Clean the gas burners regularly. The flames should be blue and burn evenly.
- Good combustion is required in gas appliances. In case of incomplete combustion, carbon monoxide (CO) might develop. Carbon monoxide is a colourless, odourless and very toxic gas, which has lethal effect even in very small doses.
- Request information about gas emergency telephone numbers and safety measures in case of gas smell from you local gas provider.

What to do when you smell gas



DANGER

Risk of explosion and poisoning!

Do not use open fire and do not smoke.

Do not operate any electric switches (e.g. light switch or door bell).

Do not use a telephone or mobile phone.

1. Close all valves on gas appliances and gas meters.
2. Open doors and windows.
3. Check all tubes and connections for tightness. If you still smell gas leave the flat.
4. Warn the neighbours.
5. Call the fire-brigade. Use a telephone outside the house.

Safety when working with electricity

- Any works on electric equipment and systems may only be carried out by authorized qualified persons.
- In case of any damage, switch off the unit and separate it from the mains supply. For this purpose, switch off the fuse.
- Be sure fuse current value is suitable to cooker current.

Intended use

The unit is designed for domestic use only. Commercial use is not admissible.

This product should not be used for heating purposes.

The manufacturer shall not be liable for any damage caused by improper use or handling errors.

The unit can be used for defrosting, baking, roasting and grilling food.

Tips for saving energy

The following tips will help you to use your appliance in an ecological way and to save energy:

- Use dark colored and enamel coated caps, since the heat transmission will be better.
- While cooking your meals, perform a preheating operation if it is advised in the user manual or cooking description.
- During cooking, do not open the oven door frequently.
- Try to cook more than one type of meal within the oven at the same time

(You can cook two different meals at the same time by locating cooking bowls on the same grill shelf). It will be suitable to cook more than one meal after each other. The oven will already be hot.

- Defrost the frozen meals before cooking them within the oven.
- You can save energy by closing your electrical oven a few minutes before the cooking time (The oven door should not be opened).
- Use pots/pans with lids for cooking. Without lid, the current consumption may be up to four times higher.
- Prefer the burner which is suitable to the saucepan base. Always choose the correct size of saucepans for your meals. For larger caps more energy is needed.

Disposal

Packaging material



DANGER

Risk of suffocation by the packaging materials!

Keep children away from the packaging materials.

The packaging material and transport locks are made from materials that are not harmful to the environment. Please dispose of all parts of the packaging according to environmental standards. This is beneficial to the environment and saves precious raw materials.

Old equipment



This product bears the selective sorting symbol for waste electrical and electronic equipment (WEEE). This means that this product must be handled pursuant to European Directive 2002/96/EC in order to be recycled or dismantled to minimize its impact on the environment. For further information, please contact your local or regional authorities.

Electronic products not included in the selective sorting process are potentially dangerous for the environment and human health due to the presence of hazardous substances.

Future transportation



NOTICE

Do not place other items on the top of the appliance. The appliance must be transported upright.

Store the appliance's original box and transport the appliance in its original carton. Follow the guidance marks that are printed on the carton.



Important

Verify the general appearance of your equipment by identifying possible damages during the transportation.

Secure the caps and pan supports with adhesive tape.

To prevent the wire shelf and tray inside the oven from damaging the oven door, place a strip of cardboard onto the inside of the oven door that lines up with the position of the trays. Tape the oven door to the side walls.

If you do not have the original carton

Pack the appliance in bubble wrap or thick cardboard and tape it securely in order to prevent damage during transportation.

3 INSTALLATION

Preparations

The kitchen floor must be able to carry the weight of the unit plus the additional weight of cookware and bakeware and food; see *Technical Data, page 5*.

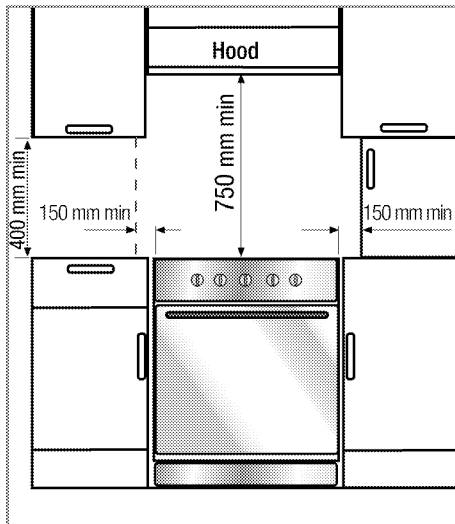

- A safety distance must be left between the unit and the kitchen walls and furniture. See figure (values in mm).
- The unit corresponds to device class 1, i.e. it may be placed with the rear and **one** side to kitchen walls, kitchen furniture or equipment of any size. The kitchen furniture or equipment on the **other** side may only be of the same size or smaller.
- Any kitchen furniture next to the unit must be heat-resistant (up to 100 °C min.).

Room ventilation

The air for combustion is taken from the room air and the exhaust gases are emitted directly into the room.

Good room ventilation is essential for safe operation of your unit. If there is no window or door available for room ventilation, an extra ventilation must be installed.

Room size	Ventilation opening
smaller than 5 m ³	min. 100 cm ²
5 m ³ bis 10 m ³	min. 50 cm ²
greater than 10 m ³	not required
In the cellar or basement	min. 65 cm ²

Installation and connection



Important

Do not install the unit next to refrigerators or freezers. The heat emitted by the unit will lead to an increased energy consumption of cooling units.

- For installation the appliance must be connected in accordance with all local gas and/or electrical regulations.
- Carry the unit with at least two persons.



NOTICE

Material damage!

The door handle must not be used for lifting or moving the unit.

- The unit must be placed directly on the floor. It must not be placed onto a base or a pedestal.

Connection to the gas supply



DANGER

Risk of explosion or poisoning by unprofessional installation.

The unit may be connected to the gas distribution system only by an authorized qualified person.



DANGER

Risk of explosion!

Before starting any work on the gas installation, please shut the gas supply.

- Pressure and type of the gas supplied from the local distribution center must correspond to the data specified on the rating plate or gas type indication label of the unit.



NOTICE

Your cooker adjusted for LP gas.

Connecting the gas hose

- If necessary, interchange the sharp hose at the rear of your oven tip with the plug by selecting a suitable place on basis of the location of the gas bottle.

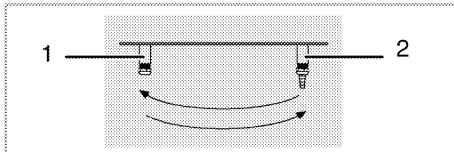

1 Plug

2 Hose nozzle

- Have your appliance connected in a way that it will be close to the gas connection and avoid gas leakage.
- Plastic hose to be used must not be longer than 125 cm.
- Install the clamp to the hose. Soak one end of the hose (15 mm inner diameter) into boiling water for one minute to soften it.
- Then, slip the softened end of the hose completely onto the sharp hose end of your appliance. Finally, tighten the clamp completely by a screwdriver.

- Repeat the same procedure for the other end of the hose and complete the gas bottle connection.
- Never forget to make the gas leakage control.



DANGER

Risk of explosion and suffocation!

LPG bottles must not be stored in the house.

- If you need to use your appliance later with a different type of gas, you must consult the authorised service for the related conversion procedure.

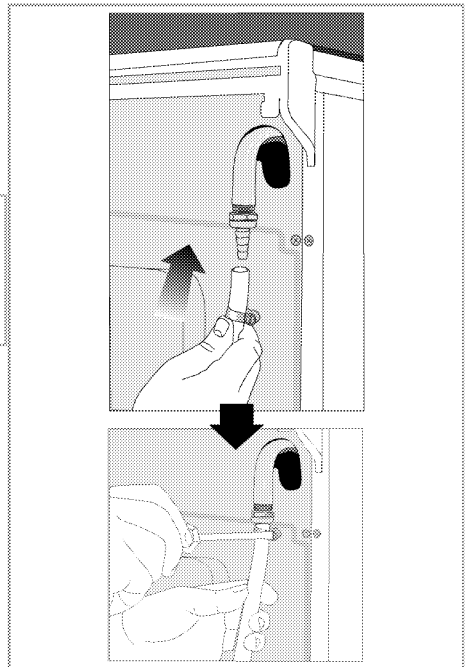

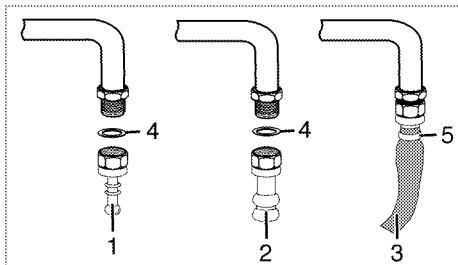

- 1 Hose nozzle-LPG
- 2 Hose nozzle-NG
- 3 Safety hose
- 4 O-ring (seal)
- 5 Clamp

Leakage control at the connection part

- Make sure that all knobs on the unit are turned off. Make sure that the gas supply is open. Prepare soapy foam and apply it onto the connection edge of the hose for gas leakage control.
- Soapy part will froth if there is a gas leakage. In this case, inspect the gas connection once again.

Important

Never use a match or lighter to make the gas leakage control.



DANGER Risk of explosion by damage of the safety tube!

The safety tube must not be clamped, bent or squeezed or come into contact with hot parts of the unit.

Connection to the mains supply



Important This appliance must be earthed!

Our company shall not held responsible for any damage caused by the utilisation of the product without ground socket.



DANGER Risk of electric shock, short circuit or fire by unprofessional installation!

The unit may be connected to the mains supply only by an authorized qualified person and the appliance is only guaranteed after the correct installation.



DANGER Risk of electric shock, short circuit or fire by damage of the supply cord!

The supply cord must not be clamped, bent or squeezed or come into contact with hot parts of the unit.

If the supply cord is damaged, it must be replaced by a qualified electrician.

- The mains supply data must correspond to the data specified on the rating plate of the unit. The rating plate is either seen when the door or the lower cover is opened or it is located at the rear wall of the unit depending on the unit type.
- The supply cable of the product must correspond to the specifications; see technical data table *Technical Data*, page 5.



Important The plug should be easily accessible after installation (but not above the hob).

Plug the supply cord into the socket.



DANGER

Risk of electric shock!

Before starting any work on the electrical installation, please disconnect the product from the mains.

- Push unit to the kitchen wall.
- To align the unit with the worktop, adjust the feet turning right or left hand as required.

Final check

1. Check electrical functions.
 2. Open gas supply.
 3. Check gas installations for secure fitting and tightness.
 4. Ignite burners and check appearance of the flame.
-



Important

The flames should be blue and burn smoothly. If the flames appear yellowish, check secure position of the burner cap or clean the burner.

Initial operation

First cleaning of the product



NOTICE

The surface might get damaged by some detergents or cleaning materials.

Do not use aggressive detergents, cleaning powder/milk or any sharp objects.

1. Remove all packaging materials.

2. Wipe the surfaces of the product with a damp cloth or sponge and dry with a cloth.

Initial heating



WARNING

Hot surfaces may cause burns!

Do not touch the hot surfaces of the unit. Keep children away from the unit and use oven gloves.



Important

Smell and smoke may emit during first heating. Ensure well ventilation.

Any production residues or conservation layers must be burnt before the first use. Heat up the device for about 30 minutes and then switch it off.

Electric oven

1. Take all baking trays and racks from the oven.
2. Close oven door.
3. Select the highest temperature with the thermostat knob; see *How to use the electric oven, page 16*.
4. Heat approximately 30 minutes.
5. Switch off oven; see *How to use the electric oven, page 16*

4 HOW TO USE THE HOB

General information on cooking



DANGER

Risk of fire by overheated oil!

When you heat oil, do not leave it unattended.

Never try to extinguish the fire with water! When oil has caught fire, immediately cover the pot or pan with a lid and remove it from the hob.

- Ensure handles of pans can not accidentally be caught or knocked and do not get heated by adjacent heating zones.

Cooking with gas

- The size of the pot and the size of the gas flame should match each other. Adjust the gas flames so that they do not go beyond the bottom of the pot and place the pot onto the pot support in a central position.

How to use hobs

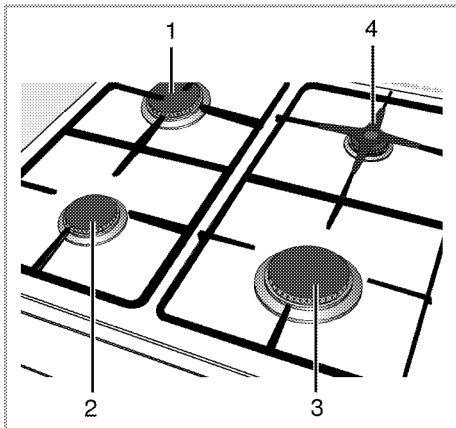

- 1 Normal burner 18-20 cm

- 2 Normal burner 18-20 cm
3 Rapid burner 22-24 cm
4 Auxiliary burner 12-18 cm is list of advised diameter of pots to be used on related burners.

The large flame symbol corresponds to the highest cooking power, the small flame symbol corresponds to the lowest cooking power. In off position (top) the gas supply to the plates is locked.

Ignite the gas burners



The gas burners are ignited by means of the ignition button.

1. Keep hob control knob pressed.
2. Turn anticlockwise to the large flame symbol.
3. Press ignition button and release it again. Repeat the process until the emanating gas is ignited.
4. Adjust the desired cooking power.

Switch off the gas burners

Turn hob control knob to off position (top).



DANGER

Risk of deflagration by gas that is not ignited!

Do not press the knob for longer than 15 seconds if there was no ignition.

Wait for one minute and then repeat the ignition process.

5 HOW TO OPERATE THE OVEN

General information on baking, roasting and grilling



DANGER

Risk of scalding by hot steam!

When the oven is in use or shortly afterwards, open the door at first only a little bit so that the steam can escape.

Tips for baking

- Use non-sticking coating appropriate metal plates or aluminum containers or heat-resistant silicone moulds.
- Make best use of the space on the rack.
- It is recommended to place the baking mould in the middle of the rack.
- Keep the oven door closed.

Tips for roasting

- Seasoning with lemon juice and black pepper will improve the cooking performance when cooking a whole chicken, turkey or a large piece of meat.
- Meat with bones takes about 15 to 30 minutes longer before it is cooked than a roast of the same size without bones.
- You should calculate about 4 to 5 minutes cooking time per centimeter height of the meat.
- Let meat rest in the oven for about 10 minutes after the cooking time. The juice is better distributed all over the roast and does not run out when the meat is cut.
- Fish in a fire-resistant dish should be placed on the rack at the medium or lower level.

How to use the electric oven

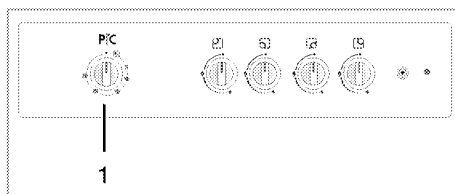

1 Function knob

Select temperature and operating mode

1. Set the function knob to the desired temperature.

» The oven heats up to the adjusted temperature and maintains it. During heating, temperature lamp stays on.

Switch off electric oven

Turn function knob to off position (top).

Operating modes

The order of operating modes shown here might deviate from the arrangement on your unit.

Defrosting/cooling



The oven is not heated. Only oven lamp plus fan (in the rear wall) are on. Frozen food is defrosted gently at room temperature, cooked food is cooled.

Other positions are for cooking; select the suitable temperature for your food type.

Cooking times table



Important

The values specified have been determined in the lab. The values suitable for you may deviate from these values.

Baking and roasting



Important

Level 1 is the **bottom** level in the oven.

Food	Dish	Insertion level &	Temperature (°C)	Cooking time (min.)
Cake	Bread mould 24 ... 26 cm	4	170 ... 180	20 ... 30
Ring cake	Cake mould 18 ... 22 cm	2	170 ... 180	30 ... 40
Cookies	Baking tray	4	170 ... 190	20 ... 30
Flaky pastry	Baking tray	4	180 ... 190	20 ... 30
Brioche	Baking tray	4	160 ... 180	20 ... 30
Pies	Baking tray	4	180	35 ... 45
Yeast dough	Roasting tray	4	180	25 ... 35
Savory pies	Baking tray	4	180 ... 190	20 ... 30
Choux pastry	Baking tray	4	180 ... 190	35 ... 45
Lasagne	Oven dish	4	170 ... 180	35 ... 45
Pizza	Baking tray	4	200 ... 220	15 ... 20
Roast beef	Baking tray	4	15 min. 250 *	90 ... 120
Lamb shoulder	Baking tray	4	15 min. 250 *	65 ... 80
Roast chicken	Baking tray	4	15 min. 250 *	55 ... 65
Turkey (5.5 kg)	Baking tray	4	25 min. 220 *	170 ... 220
Fish	Baking tray	4	200	15 ... 20
& for two levels: 4 + 6 for three levels: 2 + 4 + 6			* then 150	

6 MAINTENANCE AND CARE

General information



DANGER
Risk of electric shock!

Cut the electricity before cleaning appliance to avoid an electric shock.



DANGER
Hot surfaces may cause burns!

Allow the unit to cool down before you clean it.



NOTICE
The surface might get damaged by some detergents or cleaning materials.
Do not use aggressive detergents, cleaning powder/milk or any sharp objects.

Clean the appliance thoroughly after each use; in this way it will be possible to remove cooking residuals more easily, thus avoiding these from burning the next time the product is used.

No special cleaning agents are required for cleaning the unit. It is recommended to use warm water with washing liquid, a soft cloth or sponge and use a dry cloth for drying.

Do not use any abrasive cleaning materials!

Do not use any harsh abrasive cleaners, or hard metal scrapers to clean the glass lid as they may scratch the surface. This may destroy the glass.



Important
Do not use steam cleaners for cleaning.

How to clean the hob

Gas hobs

1. Remove pot supports and burner caps and clean them.
2. Clean the hob.
3. Refit burner caps and check that they are securely positioned.
4. Refit pot supports.

Cleaning the control panel



NOTICE
Damage of the control panel!
Do not remove the control knobs for control panel cleaning.

Clean control panel and control knobs.

Cleaning the oven

No oven cleaner or any other special cleaning agent is required for cleaning the oven. It is recommended to wipe the oven with a damp cloth while it is still warm.

Clean oven door

Don't use any harsh abrasive cleaners or sharp metal scrapers for cleaning the oven door; these agents may scratch the surface and destroy the glass.

Exchange oven lamp



DANGER
Hot surfaces may cause burns!

Make sure that the device is switched off and cooled down in order to avoid the risk of an electrical shock.

The oven lamp is a special heat-resisting (T 300 °C) electric light bulb; see *Technical Data, page 5*. Oven lamps can be obtained from service agent.

1. Switch off the current.
2. Unscrew glass cover.

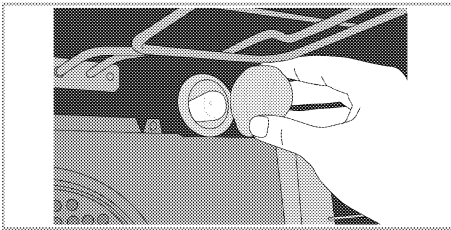

3. Unscrew oven lamp and replace it by a new one.
4. Refit the glass cover.

Troubleshooting



DANGER
Risk of electric shock, short circuit or fire by unprofessional repairs!

Repairs on the unit must be carried out by the technical service or a qualified electrician.



DANGER
Risk of explosion or poisoning by unprofessional repair.

Repairs on the unit must be carried out by the technical service or a qualified technician.

Normal operating conditions

- Smoke and smell may emit for a couple of hours during the first operation.
- It is normal that steam escapes during operation.
- When the metal parts are heated, they may expand and cause noise.

You can solve the following problems yourself. **Before you call the technical service, please check the following points.**

Electrical equipment

Malfunction/problem	Possible cause	Advice/remedy
The unit does not work.	The fuse is defective or deactivated.	Check fuses in the fuse box. If necessary, replace or reactivate them.
	Product's plug can not be connected to the grounded socket.	Check the plug connection.
Oven light is not on.	Oven lamp is defective.	Replace oven lamp.
	No current.	Check fuses in the fuse box. If necessary, replace or reactivate them.

Malfunction/problem	Possible cause	Advice/remedy
Oven does not heat.	Function knob and/thermostat knob are not set.	Set function knob and thermostat knob.
	If the product has a timer, the timer can not be set.	Set the time.
	No current.	Check mains supply and fuse box.

Gas

Malfunction/problem	Possible cause	Advice/remedy
No ignition spark is produced.	No current.	Check fuses in the fuse box.
No gas is emitted.	Main gas tap is closed.	Open gas tap.
	Safety tube is bent.	Install safety tube without bends.
Burners do not burn smoothly or not at all.	Burners are dirty.	Clean burner parts.
	Burners are not dry.	Dry burner parts.
	Burner cap is not securely positioned.	Position burner correctly.
	Gas tap is closed.	Open gas tap.
	Gas container is empty (in case of LPG connection).	Replace gas container.

If the problem has not been solved:

1. Separate unit from the mains supply (deactivate or unscrew fuse).
2. Call the technical service.