

# 10" Tilting Arbor Saw

## High quality and feature loaded.

- Magnetic motor starter with thermal overload and no-voltage protection.
- Full cabinet with motor cover for sawdust containment.
- Built-in storage for miter gage, rip fence and blade wrench.
- Extra-large cast-iron table with extension wings provides ample support for large work.
- Integral T-slot grooves prevent miter gage from falling during wide cut-off operations.
- Convenient up-front blade raising and tilting controls for safe, easy operation.

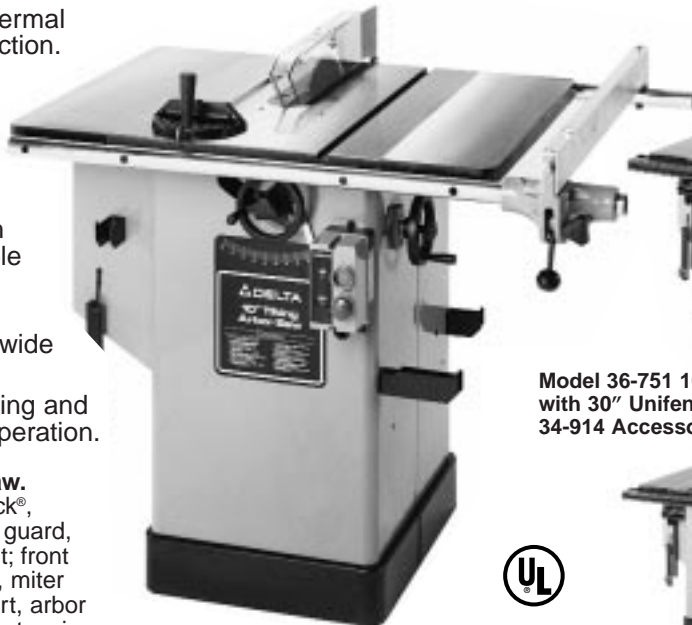

**Model 36-755 10" Tilting Arbor Saw**



**Model 36-751 10" Tilting Arbor Saw with 30" Unifence Saw Guide and 34-914 Accessory Table Board.**



**Model 36-752 10" Tilting Arbor Saw with 52" Unifence Saw Guide and 34-998 Accessory Table and Shelf Boards.**

**Model 36-755 10" Tilting Arbor Saw.**

Includes basic machine with Jet-Lock®, Micro-Set® rip fence; see-thru blade guard, splitter and anti-kickback attachment; front graduated guide bar, rear guide bar, miter gage, 10" dia. saw blade, table insert, arbor and motor pulleys, V-belt, (2) table extension wings, motor cover; 2HP, 230V, single phase, 60 Hz., TEFC motor; motor starter and instruction manual.

**Model 36-751 10" Tilting Arbor Saw with 30" Unifence® Saw Guide.**

Same as Model 36-755 above less Jet-Lock®, Micro-Set® rip fence with front and rear guide bars and (1) table extension wing, but with Unifence® Saw Guide which includes fence, carriage assembly, front guide bar, table frame, legs and mounting hardware. Less table board.

**Model 36-752 10" Tilting Arbor Saw with 52" Unifence® Saw Guide.**

Same as Model 36-755 above less Jet-Lock®, Micro-Set® rip fence with front and rear guide bars and (1) table extension wing, but with Unifence® Saw Guide which includes fence, carriage assembly, front guide bar, table frame, legs, shelf support brackets and mounting hardware. Less table and shelf boards.



**Cuts stock 3 1/8" thick;** a full 2 1/8" at 45° blade tilt. 2 HP motor delivers plenty of power for fast, efficient cutting.



**Unique "table top located" adjusting screws** for accurate setting of 45° and 90° positive blade stops.

## SPECIFICATIONS

**Motor** ..... 2 HP, 230V, 60 Hz., single phase

**Blade:**

Diameter ..... 10" (254 mm)

Arbor ..... 5/8" (16 mm)

Speed ..... 4000 rpm

**Capacity:**

Max. depth of cut 90° ..... 3 1/8" (79 mm)

Max. depth of cut 45° ..... 2 1/8" (54 mm)

Max. rip R of blade ..... 25" (635 mm)

Max. rip L of blade ..... 15 1/2" (394 mm)

Max. rip R of blade w/30" Unifence Saw Guide ..... 30" (762 mm)

Max. rip R of blade w/52" Unifence Saw Guide ..... 52" (1321 mm)

Max. rip L of blade w/30" or

52" Unifence Saw Guide ..... 8 3/4" (222 mm)

Table in front of saw blade at

max. cutting height ..... 12 1/4" (311 mm)

Max. width of dado ..... 1 3/16" (21 mm)

**Table:**

Size w/extension wings ..... 36" x 27" (914 x 686 mm)

Size w/ext. wing and 30" Unifence Saw Guide ..... 62 1/2" x 27" (1588 x 686 mm)

Size w/ext. wing and 52" Unifence Saw Guide ..... 78 1/2" x 27" (1994 x 686 mm)

Height ..... 34 1/4" (870 mm)

Miter gage groove ..... 3/8" x 3/4" (10 x 19 mm)

**Overall Dimensions:**

Width ..... 45" (1143 mm)

Width w/30" Unifence Saw Guide ..... 67 1/2" (1715 mm)

Width w/52" Unifence Saw Guide ..... 83" (2108 mm)

Depth ..... 32" (813 mm)

Height ..... 39" (991 mm)

**Weight:** Model 36-755 ..... 288 lbs. (131 kg)

Model 36-751 ..... 290 lbs. (132 kg)

Model 36-752 ..... 293 lbs. (133 kg)

# 10" Contractor's Saw®

## New Series 2000 10" Contractor's Saws take woodworking into the next century.

- Series 2000 10" Contractor's Saws are available with your choice of the UniRip Fence, Unifence®, Precision Saw Guide or Biesemeyer Saw Fence systems.
- New UniRip T-Square style fence (model 36-444 only) offers up to 30" of right-hand cutting capacity. Provides additional stock support in front of the blade and includes built-in T-slots for adding jigs or other accessories.
- Each Series 2000 10" Contractor's Saw comes with a new sturdy steel stand that features an integral dust chute for improved dust collection and built-in storage for rip fence, miter gage and blade wrenches.
- Maximum 3 1/8" depth of cut at 90°; 2 1/8" at 45° for clean cutting of standard stock sizes.
- Patented Auto-Set® T-Slot miter gage with adjustable stops at 90° and 45° positions for accurate straight and angle cutting.
- Integral T-slot table grooves prevent miter gage from falling during wide cut-off operations.
- Extra-large table provides ample support for large work.
- Unique "table top located" adjusting screws for accurate setting of 45° & 90° positive blade stops.
- Large on/off paddle switch is positioned near the top of the table for quick access.
- Convenient up-front blade raising and tilting controls for safe, easy operation.
- Heavy-duty 1 1/2 HP induction motor delivers plenty of extra power and speed for the toughest cutting jobs.



Model 36-444  
10" Contractor's Saw®

Model 36-445  
10" Contractor's Saw®  
with 30" Unifence  
Saw Guide



**Model 36-444 10" Contractor's Saw®.** Includes basic machine with two table extension wings, stand, belt and pulley guard, see-thru blade guard with splitter and anti-kickback attachment, miter gage, UniRip fence with front and rear guide bars, 10" saw blade, V-belt, arbor and motor pulleys plus 1 1/2 HP, 115/230V, single phase motor.

**Model 36-445 10" Contractor's Saw® with 30" Unifence® Saw Guide.** Same as model 36-444 but with one table extension wing and 30" Unifence® Saw Guide which includes front and rear guide bars, table support legs and mounting hardware. Less table board.

**Model 36-440 10" Contractor's Saw® with 29" Precision Saw Guide.** Same as model 36-444 but with one table wing extension and 29" Precision Saw Guide which includes fence, carriage assembly, front guide rail, table frame and mounting hardware. Less table board and legs.

**Model 36-450 10" Contractor's Saw® with 50" Precision Saw Guide.** Same as model 36-444, but with one table extension wing and 50" Precision Saw Guide which includes fence, carriage assembly, front guide rail, table frame, table support legs and mounting hardware. Less table board.



Model 36-440  
10" Contractor's  
Saw® with  
29" Precision  
Saw Guide

# 10" Contractor's Saw®

**Model 36-460 10" Contractor's Saw® with 28" Biesemeyer T-Square® Home Shop Saw Fence System.** Same as model 36-444, but with one table extension wing and 28" Biesemeyer T-Square® Home Shop Saw Fence System which includes T-Square fence, front and rear rails, guide tube and mounting hardware. Less table board and legs.

**Model 36-470 10" Contractor's Saw® with 40" Biesemeyer T-Square® Home Shop Saw Fence System.** Same as model 36-444, but with one table extension wing and 40" Biesemeyer T-Square® Home Shop Saw Fence System which includes T-Square fence, front and rear rails, table support legs, guide tube and mounting hardware. Less table board.

**Model 36-480 10" Contractor's Saw® with 52" Biesemeyer T-Square® Home Shop Saw Fence System.** Same as model 36-444, but with one table extension wing and 52" Biesemeyer T-Square® Home Shop Saw Fence System which includes T-Square fence, front and rear rails, table support legs, guide tube and mounting hardware. Less table board.

**Model 36-490 10" Contractor's Saw® with 30" Biesemeyer T-Square® Commercial Saw Fence System.** Same as model 36-444, but with one table extension wing and 30" Biesemeyer T-Square® Commercial Saw Fence System which includes T-Square fence, front and rear rails, guide tube and mounting hardware. Less table board and legs.



**Model 36-480  
10" Contractor's Saw®  
with 52" Biesemeyer  
T-Square® Home Shop  
Saw Fence System**



**Model 36-490  
10" Contractor's Saw®  
with 30" Biesemeyer  
T-Square® Commercial  
Saw Fence System**

## SPECIFICATIONS

**Motor** ..... 1½ HP, 115/230V, 60 Hz., single phase

**Blade:**

Diameter..... 10" (254 mm)  
Arbor..... 5/8" (16 mm)  
Speed ..... 3000 rpm

**Capacities:**

Max. depth of cut ..... 3 1/8" (79 mm)  
Max. depth of cut at 45° ..... 2 1/8" (54 mm)  
Max. rip to right of blade for:  
Model 36-444 ..... 30" (762 mm)  
Model 36-445 ..... 30" (762 mm)  
Model 36-440 ..... 29" (737 mm)  
Model 36-450 ..... 50" (1270 mm)  
Model 36-460 ..... 28" (711 mm)  
Model 36-470 ..... 40" (1016 mm)  
Model 36-480 ..... 52" (1321 mm)  
Model 36-490 ..... 30" (762 mm)  
Max. rip to left of blade for:  
Model 36-444 ..... 13 1/2" (343 mm)  
Model 36-445 ..... 8 3/4" (222 mm)  
Models 36-440, 36-450, 36-460, 36-470, 36-480 and 36-490 ..... 12" (305 mm)  
Table in front of saw at  
max. depth of cut ..... 12 1/4" (311 mm)  
Max. width of dado ..... 1 3/16" (21 mm)

**Table:**

Size ..... 20" x 27" (508 x 686 mm)  
Size with extension wings ..... 40" x 27" (1016 x 686 mm)  
Size with extension wing and:  
Unifence table board ..... 62" x 27" (1575 x 686 mm)  
29" Precision Saw Guide table board ..... 54" x 27" (1372 x 686 mm)  
50" Precision Saw Guide table board ..... 78" x 27" (1981 x 686 mm)  
28" Biesemeyer T-Square Home Shop Saw Fence System ..... 52" x 27" (1321 x 686 mm)  
40" Biesemeyer T-Square Home Shop Fence System ..... 64" x 27" (1626 x 686 mm)  
52" Biesemeyer T-Square Home Shop Fence System ..... 76" x 27" (1930 x 686 mm)  
30" Biesemeyer T-Square Commercial Saw Fence System ..... 54" x 27" (1372 x 686 mm)  
Miter gage groove ..... 3/8" x 3/4" (10 x 19 mm)  
Height on steel stand ..... 34 1/4" (185 mm)

**Overall Dimensions:**

Height (on steel stand) ..... 39" (991 mm)  
Width with wings and guide bar ..... 57" (1448 mm)  
Width with wing and:  
Model 36-445 ..... 62" (1575 mm)  
Model 36-440 ..... 59" (1499 mm)  
Model 36-450 ..... 80" (2032 mm)  
Model 36-460 ..... 58" (1473 mm)  
Model 36-470 ..... 70" (1778 mm)  
Model 36-480 ..... 82" (2083 mm)  
Model 36-490 ..... 60" (1524 mm)  
Depth Model 36-444 ..... 42" (1067 mm)  
Models 36-445, 36-440 and 36-450 ..... 43" (1092 mm)  
Models 36-460, 36-470 and 36-480 ..... 36" (914 mm)  
Model 36-490 ..... 42" (1067 mm)  
**Weight:**  
Model 36-444 ..... 220 lbs. (99 kg)  
Model 36-445 ..... 248 lbs. (112 kg)  
Model 36-440 ..... 245 lbs. (111 kg)  
Model 36-450 ..... 266 lbs. (120 kg)  
Model 36-460 ..... 267 lbs. (121 kg)  
Model 36-470 ..... 275 lbs. (125 kg)  
Model 36-480 ..... 282 lbs. (128 kg)  
Model 36-490 ..... 286 lbs. (130 kg)



# 10" Contractor's Saw® II

**Solid construction and quality features make this saw one smooth operator.**

- Powerful 1½ HP, single phase induction motor provides the power to handle any cutting operation.
- Auto-Set® T-Slot miter gage has adjustable stops at 45° and 90° for precision straight and angle cutting jobs.
- Rack and worm gear blade elevating mechanism raises and lowers blade smoothly and easily.
- See-through blade guard with splitter and anti-kickback fingers promotes operator safety.
- Accessory dust collector connector mounts to saw carriage for attaching a dust collection system right at the source of dust and chips.
- Large on/off paddle switch.

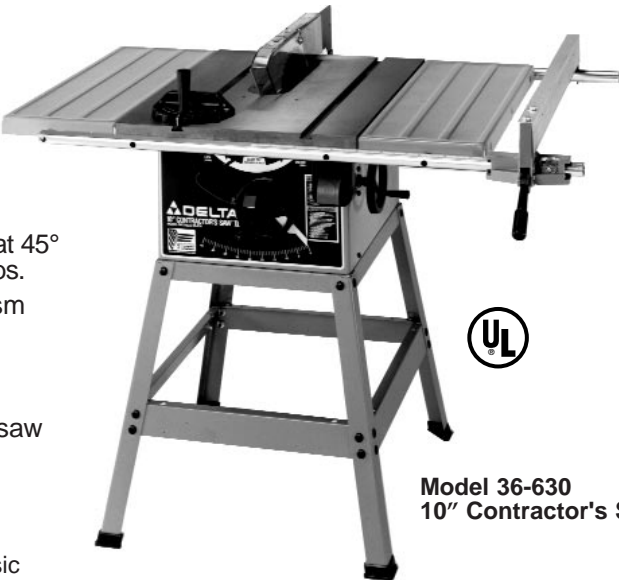

**Model 36-630  
10" Contractor's Saw® II**

**Model 36-630 10" Contractor's Saw® II.** Includes basic machine with 1½ HP, single phase motor, blade guard, splitter and anti-kickback fingers, Jet-Lock® rip fence, guide bars, Auto-Set® miter gage, 10" saw blade, table insert, arbor pulley, motor pulley, V-belt, two extension wings, steel leg stand and instruction manual.

**Model 36-640 10" Contractor's Saw® II with Precision Saw Guide.** Same as above less Jet-Lock® rip fence with front and rear guide bars and one table extension wing, but with 29" Precision Saw Guide, carriage assembly, front guide rail, table frame, mounting hardware and instruction manual. Less table board.



**Model 36-640 10" Contractor's Saw II  
with 29" Precision Saw Guide**



**Cast iron 20" x 27" table** with T-slotted miter gage grooves and two extension wings.



**Self-aligning Jet-Lock® Micro-Set® rip fence** glides on chrome-plated rails.

## SPECIFICATIONS

<b>Motor</b> .....	1½ HP, 115/230V, single phase, 60 Hz.
<b>Blade:</b>	
Diameter .....	10" (254 mm)
Arbor .....	5/8" (16 mm)
Speed .....	3000 rpm
<b>Capacity:</b>	
Maximum depth of cut at 90° .....	3 1/8" (79 mm)
Maximum depth of cut at 45° .....	2 1/8" (54 mm)
Maximum rip to right of blade:	
Model 36-630 .....	24" (610 mm)
Model 36-640 .....	29" (737 mm)
Maximum rip to left of blade .....	12 1/4" (311 mm)
Table in front of saw blade at max. cut .....	12 1/4" (311 mm)
Maximum width of dado .....	1 3/16" (21 mm)

<b>Table:</b>	
Size .....	20" x 27" (508 x 686 mm)
Size with extension wings .....	40" x 27" (1016 x 686 mm)
Height .....	35 1/2" (902 mm)
T-slotted miter gage grooves .....	3/8" x 3/4" (10 x 19 mm)
<b>Overall Dimensions:</b>	
Length:	
Model 36-630 .....	44" (1118 mm)
Model 36-640 .....	42" (1067 mm)
Width:	
Model 36-630 .....	48" (1219 mm)
Model 36-640 .....	59" (1499 mm)
Height:	
Model 36-630 .....	40" (1016 mm)
Model 36-640 .....	40 1/2" (1029 mm)
<b>Weight:</b>	
Model 36-630 .....	188 lbs. (85 kg)
Model 36-640 .....	202 lbs. (92 kg)

# 10" Table Saw

The home shop saw that combines power with precision T-square® accuracy.

- Powerful 15 amp. motor provides 5500 rpm blade speed.
- Full 22¼" x 38¾" table with extension wings provides ample work support for ripping large panels.
- Maximum 3⅛" depth of cut at 90°, 2⅞" at 45° blade tilt. Rips to the center of a 4' panel.
- T-Square® Fence System for precision accuracy.
- See-thru blade guard with anti-kickback fingers.
- Miter gage with 45° R&L and 90° stops for accurate angle cutting.
- T-slot miter gage grooves hold miter gage beyond table.

**Model 36-600 10" Table Saw.** Includes basic machine with 15 amp., 115V, single phase motor, stand, miter gage, T-Square rip fence, table insert, see-thru blade guard with splitter and anti-kickback fingers, 10" carbide-tipped saw blade, wrench and instruction manual.



**Model 36-600  
10" Table Saw**



**Full 22¼" x 38¾" table** with extension wings and T-slot grooves provides ample work support for ripping large panels.



**Miter gage** has positive stops at 45° and 90° for accurate angle cutting. Compound angles can be achieved by tilting blade.



**Saw can be converted** for moulding operations with accessory cutterhead and table insert.



**Cut dados in any width** up to 1⅜" simply by mounting accessory dado and table insert.

## SPECIFICATIONS

**Motor** ..... 15 amp., 115V, 60 Hz.

**Blade:**

Diameter of Arbor ..... 5/8" (16 mm)

Speed ..... 5500 rpm

Diameter of Blade ..... 10" (254 mm)

**Capacity:**

Max. depth of cut at 90° ..... 3⅛" (79 mm)

Max. depth of cut at 45° ..... 2⅞" (54 mm)

Table distance in front of blade at

1" depth of cut ..... 11¾" (298 mm)

Max. width of dado ..... 1⅜" (21 mm)

Max. rip to right of blade ..... 27" (686 mm)

**Table:**

Size ..... 22¼" x 20¾" (565 x 518 mm)

Size with both extension wings ..... 22¼" x 38¾" (565 x 975 mm)

Height on stand ..... 34 7/8" (886 mm)

Miter gage groove ..... 3/8" x 3/4" (10 x 19 mm)

**Overall Dimensions:**

Height ..... 40" (1016 mm)

Width ..... 51" (1295 mm)

Depth ..... 35½" (902 mm)

**Weight** ..... 145 lbs. (66 kg)

# Sidekick® 8¼" Builder's Saw®

## The Builder's Saw that's got it all.

- Cuts 2¼" at 90°; 1⅝" at 45° blade tilt—enough capacity to cut dimensional 2 x 4 lumber.
- Diecast aluminum table, with integral outfeed work support and T-slot miter gage grooves, measures a full 26" x 20".
- Miter gage with adjustable positive stops at 90° and 45° R&L for accurate straight and angle cutting.
- Self-aligning rip fence with single control handle and easy-to-read English/Metric rip scale.
- Carbide-tipped 8¼" dia. x 18 ATB saw blade included as standard equipment.
- Built-in holders and compartments for miter gage, cord, rip fence, blade guard, extra blade and wrench set storage.

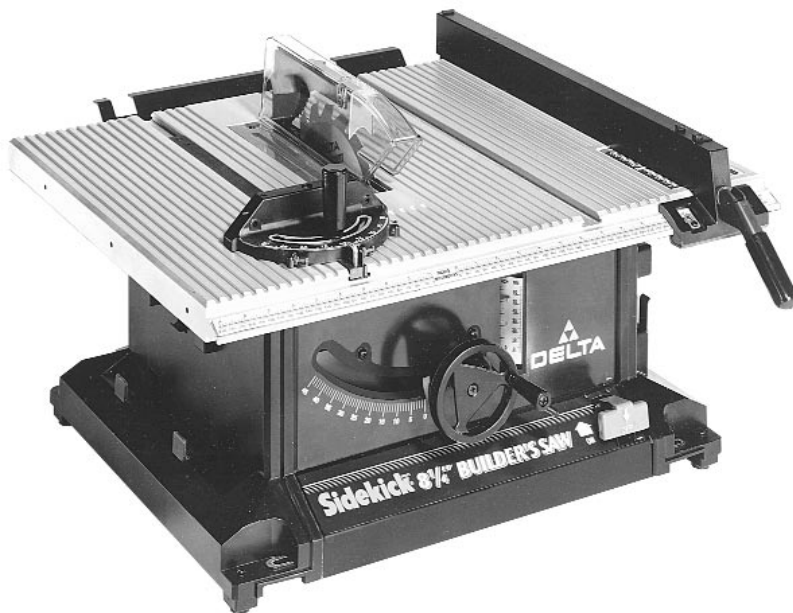

**Model 36-275 Sidekick® 8¼" Builder's Saw®.** Includes basic machine with 15 amp., 120V, 60 Hz. motor; rip fence, miter gage, see-through blade guard with splitter and anti-kickback fingers, carbide-tipped 8¼" dia. x 18 ATB saw blade, table insert, wrenches and instruction manual.



**Model 36-275  
Sidekick® 8¼" Builder's  
Saw®**



**Integral outfeed work support** handles large panels and long stock; slides in, out of the way, when not in use.



**T-slot grooves** hold miter gage securely beyond front of table, preventing it from falling during wide cut-off operations.



**Built-in holders and compartments** for out-of-the-way miter gage, rip fence, blade guard, extra blade and wrench set storage; easier accessibility when needed.



**Convenient carrying handle** and cord holder bracket for safe and easy transport from job to job.

## SPECIFICATIONS

**Motor** ..... 15 amp., 120V, single phase, 60 Hz.

**Blade:**

Diameter ..... 8¼" (210 mm)

Arbor ..... ⅝" (16 mm)

Speed ..... 4500 rpm

**Capacity:**

Maximum depth of cut at 90° ..... 2¼" (57 mm)

Maximum depth of cut at 45° ..... 1⅝" (41 mm)

Maximum rip to right of blade ..... 12" (305 mm)

Table in front of blade at 1" depth of cut ..... 8" (203 mm)

Maximum width of dado ..... 1⅜" (21 mm)

**Table:**

Size ..... 26" x 20" (660 x 508 mm)

with accessory extension wing ..... 32" x 20" (813 x 508 mm)

Height ..... 12⅛" (308 mm)

T-slot ..... ⅜" x ¾" (10 x 19 mm)

**Overall Dimensions:**

Height ..... 15⅞" (403 mm)

Width ..... 26" (660 mm)

Depth ..... 25⅜" (645 mm)

**Weight** ..... 48½ lbs. (22 kg)



# 10" Bench Saw

## Big saw capacity in an economical package.

- Lightweight for portability; goes where you go, when you need it.
- Ample capacity to cut 3" at 90°; 2½" at 45°.
- Powered by a heavy duty 13 amp., 115V motor for dependability.
- Rip fence locks front and rear to maintain accuracy at the cut.
- Blade tilting and height control knobs are up-front for convenience.
- Self-aligning rip fence aligns and locks itself parallel to blade with single control lever.
- Big 17¼" x 26" table provides ample support for large ripping operations.
- Removable on-off switch to prevent unauthorized use.
- Convenient holder for out-of-the-way miter gage storage.
- See-thru blade guard with integral splitter and anti-kickback fingers for operator safety.



**Model 36-540  
10" Bench Saw**

**Model 36-540 Type 2 10" Bench Saw.** Includes basic machine with 13 amp., 115V, 60 Hz. motor; rip fence, miter gage, see-thru blade guard with splitter and anti-kickback fingers, 10" carbide-tipped saw blade, standard table insert, blade wrenches and instruction manual.

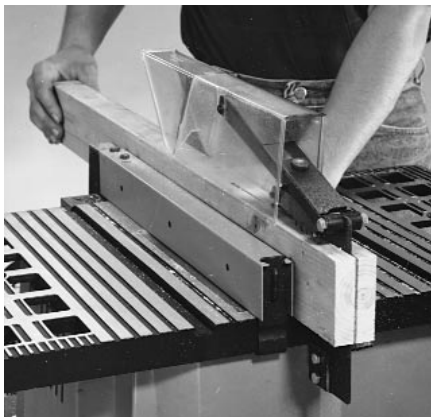

**Cuts stock 3" thick at 90°**, offers full 2½" cutting capacity at 45° blade tilt.



**T-slot table groove** prevents miter gage from falling during wide cut-off operations.



**Model 36-545 10" Bench Saw with Stand.** Same as above, but with steel stand.

## SPECIFICATIONS

**Motor** ..... 13 amp., 115V, single phase, 60 Hz.

**Blade:**

Diameter ..... 10" (254 mm)  
 Arbor ..... 5/8" (16 mm)  
 Speed ..... 4700 rpm

**Capacity:**

Max. depth of cut at 90° ..... 3" (76 mm)  
 Max. depth of cut at 45° ..... 2½" (64 mm)  
 Max. rip to right of blade ..... 9 7/8" (252 mm)  
 Max. width of cut-off at 1" depth of cut  
     with T-slot miter gage ..... 10" (254 mm)  
 Max. width of dado ..... ½" (13 mm)

**Table:**

Size ..... 17¼" x 26" (438 x 660 mm)  
 T-slot ..... 3/16" x 5/8" (5 x 16 mm)

**Overall Dimensions:**

Model 36-540 ..... 15"H x 26"W x 24"D (381 x 660 x 610 mm)  
 Model 36-545 ..... 39"H x 26"W x 24"D (991 x 660 x 610 mm)

**Weight:**

Model 36-540 ..... 40 lbs. (18 kg)  
 Model 36-545 ..... 51 lbs. (23 kg)

# Sidekick® Saw Stand

**Adds sturdy support and complete job-site mobility.**

- Holds Delta 8¼" and 10" Bench Saws as well as most other competitive models.
- Storage slots hold rip fence out of the way when not in use.
- Two-year limited warranty.

**Model 50-170 Sidekick® Saw Stand.** Includes stand, folding legs, fence guide rail, 13" diameter wheels, hardware and instruction manual.



**Model 50-170 Sidekick® Saw Stand.**  
Sidekick 8¼" Builder's Saw not included.



**Precision fence and guide rail** included for ripping operations to the right and left of saw blade.



**Folds flat** for storing or transporting from job to job.



**The Sidekick Saw Stand** helps you move your bench saw quickly and easily.



**Large 13" diameter wheels** for quick, easy movement—even up steps.

## SPECIFICATIONS

**Overall Dimensions:**

Length ..... 73" (1854 mm)  
 Width ..... 27" (686 mm)  
 Height ..... 35½" (902 mm)

**Opening Size:** ..... 22¼" x 23" (565 x 584 mm)

**Weight: (without saw)** ..... 65 lbs. (29 kg)

**Rip Capacity (to right of blade):**

With Model 36-275 Sidekick 8¼" Builder's Saw ..... 27" (686 mm)

Note: Rip capacity may vary according to your bench saw model.

## ACCESSORIES

**No. 50-171 Rear Outfeed Work Support.** Provides an additional 12" of stock support.



# Deluxe Sawbuck® Frame and Trim Saw

Try it once and you won't be able to get along without it.

- Perfect for crosscuts up to 16" at 90°, 12" at 45° on hard and soft woods, vinyl and aluminum siding.
- Saw head miterers and tilts for angle and compound cutting operations.
- Large 29<sup>13</sup>/<sub>16</sub>" miter scale has 1/4" between degree markings for easy reading with positive stops at 0°, 22<sup>1</sup>/<sub>2</sub>° and 45° R and L including a special 31.62° position for cutting crown mouldings.
- Exclusive SMC construction eliminates table rust and corrosion; steel guide bars are Nitrotec™ treated for rust-free, smooth gliding operation.
- Powerful 15 amp. gear driven motor features an electric brake that automatically stops blade in seconds after the switch trigger is released.

**Model 33-055 Deluxe Sawbuck® Frame and Trim Saw.** Includes basic machine with 15 amp., 115V, 25-60 Hz., AC motor with electric automatic brake, 6 foot cord, leg set, blade guard with retractable leaf guard, 8" diameter crosscut saw blade, blade wrench and instruction manual.



**Model 33-055  
Deluxe Sawbuck®  
Frame and Trim Saw**



**Special 31.62° miter stop and 33.85° bevel setting** facilitates compound cutting standard 52°/38° crown moulding.



**Table is made of an entirely new reinforced polyester resin compound** that prevents warping, springing and rusting. Cutting head is supported at both ends by corrosion-proof steel guide rails.

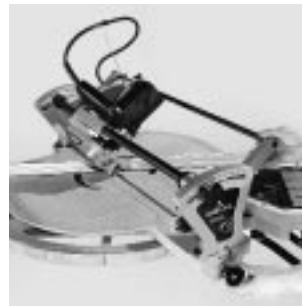

**Set-up is simple and fast.** Table rotates with track arm for mitering. Motor tilts around common table-level pivot point for beveling.

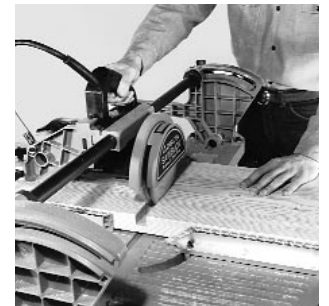

**Deluxe Sawbuck accommodates** accessory 6" diameter stackable type dado head to cut grooves up to 1<sup>3</sup>/<sub>16</sub>" wide.

## SPECIFICATIONS

<b>Motor</b> .....	15 amp., 115V, 25-60 Hz., AC
<b>Brake</b> .....	Electric, automatic
<b>Blade:</b>	
Diameter .....	8" (203 mm)
Arbor .....	5/8" (16 mm)
Speed .....	5500 rpm
<b>Capacity:</b>	
Cut-Off at 90° .....	16" (406 mm)
Cut-Off at 45° .....	12" (305 mm)
Depth of cut at 90° .....	2 <sup>3</sup> / <sub>4</sub> " (70 mm)
Depth of cut at 45° .....	1 <sup>3</sup> / <sub>4</sub> " (44 mm)
Dado .....	1 <sup>3</sup> / <sub>16</sub> " (21 mm) Width using 6" Diameter Stackable Type

<b>Cutting Head Height Adj.</b> .....	1 <sup>1</sup> / <sub>4</sub> " (32 mm) max.
<b>Table:</b>	
Diameter of cutting surface .....	28 <sup>1</sup> / <sub>2</sub> " (724 mm)
Extension on both sides of table .....	11 <sup>3</sup> / <sub>4</sub> " (298 mm)
Overall length .....	52" (1321 mm)
Height .....	35 <sup>1</sup> / <sub>4</sub> " (895 mm)
Fences .....	23" (584 mm) R & L of Blade
<b>Positive Stops:</b>	
Miter .....	0°, 22 <sup>1</sup> / <sub>2</sub> °, 31.62° & 45° R & L
<b>Overall Dimensions</b> .....	37" x 67 <sup>1</sup> / <sub>2</sub> " x 47" (940 x 1715 x 1194 mm)
<b>Weight</b> .....	96 lbs. (44 kg)

# Sidekick® 10" Sliding Compound Miter Saw

Packed with features that place it on the cutting edge.

- Cuts 11½" at 90° and 8" at 45° miter; 3⅝" depth of cut at 90° and 2" at 45° bevel.
- Powerful 15 amp. motor provides plenty of cutting power.
- Built-in arbor lock for easy blade changes.
- Standard-equipped stand features built-in left and right table extensions, with stock stops and wrench storage, that total 59" in length.
- Carbide-tipped 10" dia. x 40 ATB saw blade included as standard equipment.
- Electric blade brake automatically stops blade in seconds.
- Dust bag collects fine dust and chips for cleaner work environment.
- Extra long 10' cord for increased on-the-job mobility.



**Model 36-250 Sidekick® 10" Sliding Compound Miter Saw**

**Model 36-250 Sidekick® 10" Sliding Compound Miter Saw.** Includes basic machine with 15 amp., 120V, 60 Hz. motor; 10' 3-conductor cord with ground-type plug, electric blade brake, carbide-tipped 10" dia. x 40 ATB saw blade, base mounting feet, stand with table extensions and stock stops, work clamp, retractable saw blade guard, dust bag, wrench and instruction manual.



**Quick-action miter lock** eliminates use of traditional screw locks for faster miter setting.



**Patented stand folds quickly** for carrying saw easily; removes for bench mounting.



**One-piece die-cast aluminum table** has dual rod, linear ball bearing guide system for precision cutting.

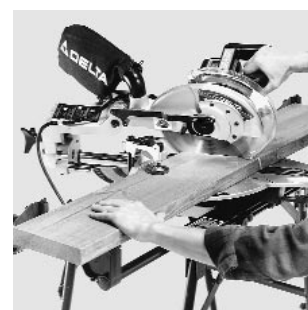

**Work clamp** secures stock, preventing material shifting for increased cutting accuracy and operator safety.

## SPECIFICATIONS

<b>Motor</b> .....	15 amp., 120V, 60 Hz.
<b>Blade:</b>	
Diameter .....	10" (254 mm)
Arbor .....	5/8" (16 mm)
Speed .....	5000 rpm
<b>Capacity:</b>	
Cut-off at 90° .....	11½" (305 mm)
Cut-off at 45° miter .....	8" (203 mm)
Depth of cut at 90° .....	3⅝" (92 mm)
Depth of cut at 45° bevel .....	2" (51 mm)
<b>Table:</b>	
Diameter of cutting surface .....	19" (483 mm)
<b>Fence:</b>	
Length .....	19" (483 mm)
Fence length with extensions .....	59" (1499 mm)

<b>Positive miter stops</b> .....	0°, 22½° 31.62° & 45°, R&L
<b>Bevel stops</b> .....	0° and 45° L
<b>Overall Dimensions with Stand and Table Extensions:</b>	
Height .....	54½" (1384 mm)
Width .....	59" (1499 mm)
Depth .....	25½" (648 mm)
<b>Without Stand:</b>	
Height .....	25¾" (654 mm)
Width .....	28½" (724 mm)
Depth .....	25" (635 mm)
<b>Weight with Stand</b> .....	56 lbs. (25 kg)

# Sidekick® 10" Sliding Compound Miter Saw

A powerful, portable compound slide saw built for today's job sites.

- Powerful 15 amp. motor handles the toughest cutting jobs.
- Die-cast aluminum table with large, easy-to-read English/Metric miter scale.
- Dual rod, linear ball-bearing guide system provides precision cutting performance.
- Secondary left and right fence supports to handle thick workpieces or long stock.
- Patented base mounts on job site 2 x 4's for fast, easy on-site setup.
- Quick-action miter lock is designed for faster miter settings.
- Handy work clamp prevents stock from shifting to maintain cutting accuracy.

**Model 36-240 Delta Sidekick 10" Sliding Compound Miter Saw.** Includes basic machine with 15 amp., 120V motor, 10-ft. 3-conductor cord with grounding plug, electric blade brake, carbide-tipped 10" dia. saw blade, work clamp, retractable blade guard, dust bag, wrench and instruction manual.



**Model 36-240 Sidekick® 10" Sliding Compound Miter Saw**



**Patented base fits over 2 x 4's** for setting up shop anywhere around the job site.



**Built-in head lock** keeps saw head in place for transporting safely from job to job.



**Designed for large cutting capacity**, this saw cuts stock up to 3<sup>5</sup>/<sub>8</sub>" deep and up to 2" deep when positioned at a 45° bevel.



**Large, easy-grip handle** is positioned horizontally for better operating control and to reduce operator fatigue.

## SPECIFICATIONS

**Motor** ..... 15 amp., 120V, 60 Hz.

**Blade:**

Diameter ..... 10" (254 mm)  
 Arbor ..... 5/8" (16 mm)  
 Speed ..... 5000 rpm

**Capacity:**

Cut-Off at 90° ..... 11 1/2" (292 mm)  
 Cut-Off at 45° Miter ..... 8" (203 mm)  
 Depth of Cut at 90° ..... 3 5/8" (92 mm)  
 Max. Depth of Cut at 45° Bevel ..... 2" (51 mm)

**Table:**

Diameter of Cutting Surface ..... 19" (483 mm)

**Fence:**

Length ..... 19" (483 mm)  
 Fence Length with Supports ..... 26" (660 mm)

**Positive Miter Stops** ..... 0°, 22 1/2°, 31.62° & 45° R & L

**Bevel Stops** ..... 0° and 45° L

**Overall Dimensions:**

Length ..... 26" (660 mm)  
 Width ..... 27" (686 mm)  
 Height ..... 19" (483 mm)

**Weight** ..... 51 lbs. (23 kg)





# Sidekick® 10" Compound Miter Saw

From crosscuts to compounds—this one's got all the angles covered.

- Powerful 15 amp., motor provides plenty of power for tough cutting jobs.
- Electric blade brake automatically stops saw blade in seconds.
- Bevel scale for quick, easy blade tilt settings with adjustable positive stops at 0° and 45° L.
- Built-in arbor lock for easy, single wrench blade changes.
- Work clamp to securely hold stock for more accurate cutting.
- Convenient lock handle vertically clamps the rotating table at the selected miter setting; lessening distortion or variances in miter settings common to table edge locking systems.
- Lubricated-for-life ball bearings at vital wear points to assure trouble-free performance with less maintenance.
- High-quality steel 10" diameter, 40T carbide-tipped blade included as standard equipment.

**Model 36-210 Sidekick® 10" Compound Miter Box.** Includes basic machine with 15 amp., 120V, 60Hz. motor; 5' 3-conductor cord with grounding type plug, electric blade brake, 10" diameter carbide-tipped saw blade, retractable blade guard, dust bag, work clamp, wrench and instruction manual.



**Model 36-210 Sidekick® 10" Compound Miter Box**



**Aggressive 15 amp. motor** develops plenty of power to crosscut a nominal 2x6 or 4x4 at 90°; miter 2x4 flat or on edge at 45° R&L.



**Versatile tilting blade** allows you to bevel cut a nominal 2 x 6 at 45°, compound angle cut a 2x4 at 45° miter and 45° bevel cutting position.



**Patented trigger-controlled miter indexing mechanism** facilitates quick, easy and accurate selection of 0°, 22½° and 45° R & L miter settings.

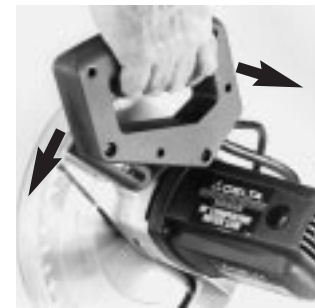

**Multi-position handle** is vertically adjustable for operator preference, comfort and convenience. Provides better control; lessens operator fatigue.

## SPECIFICATIONS

<b>Motor</b> .....	15 amp., 120V, 60 Hz.
<b>Blade:</b>	
Diameter .....	10" (254 mm)
Arbor .....	5/8" (16 mm)
Speed .....	5000 rpm
<b>Capacity:</b>	
Crosscut .....	5 5/8" x 2 1/2" (143 x 64 mm)
	3 1/2" x 3 1/2" (89 x 89 mm)
Miter at 45° R & L .....	4" x 2 1/2" (102 x 64 mm)
	3 1/2" x 2 1/2" (89 x 64 mm)
Bevel at 45° L .....	5 5/8" x 1 5/8" (143 x 41 mm)
Compound 45° x 45° .....	4" x 1 5/8" (102 x 41 mm)

<b>Fence Size R &amp; L</b> .....	2 1/2" x 8 1/2" (64 x 216 mm)
<b>Table:</b>	
Diameter .....	10 3/8" (264 mm)
Sides .....	3 3/4" (95 mm)
Miter Stops .....	0°, 22 1/2° and 45° R & L
Bevel Stops .....	0° and 45° L
<b>Overall Dimensions:</b>	
Height .....	20" (508 mm)
Width .....	18 1/4" (464 mm)
Depth .....	28" (711 mm)
<b>Weight</b> .....	30 lbs. (14 kg)

# Sidekick® 10" Motorized Miter Box

**A true cutting friend that will help cut those big jobs down to size.**

- Powerful 12 amp. motor provides plenty of power for tough cutting jobs.
- Electric blade brake automatically stops saw blade in seconds.
- Lightweight aluminum alloy construction—weighs only 30 pounds. Easily carried from job to job.
- Extra-wide one-piece fence for maximum support of extra-wide materials.
- Efficient dust collection system with strategically positioned baffle and dust spout, collects up to 80% of all fine dust particles and wood chips.
- Patented base design for either bench or job site 2x4 sawhorse mounting.
- Built-in arbor lock for easy, single wrench blade changes.
- See-through blade guard covers blade at all times, automatically retracts as cut is being made.

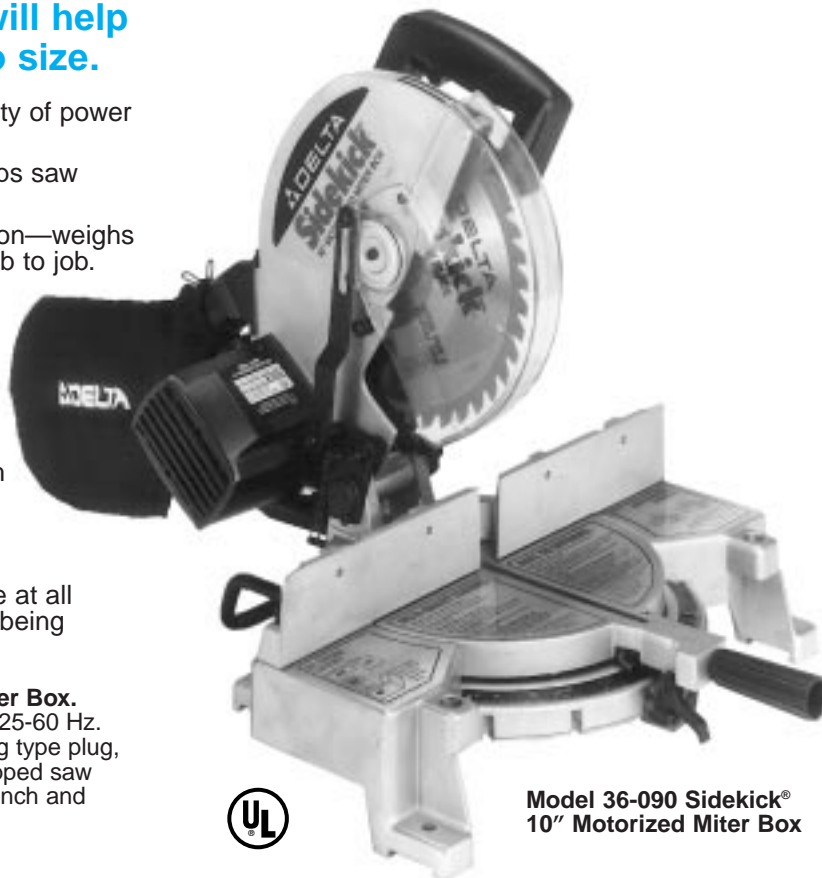

**Model 36-090 Sidekick® 10" Motorized Miter Box**



**Model 36-090 Sidekick® 10" Motorized Miter Box.** Includes basic machine with 12 amp., 120V, 25-60 Hz. motor; 6 foot 3-conductor cord with grounding type plug, electric blade brake, 10" diameter carbide-tipped saw blade, retractable blade guard, dust bag, wrench and instruction manual.



**Multi-position D-handle control.** Vertically adjustable, for operator preference, comfort and convenience. Provides better control for easier, more efficient cutting with less operator fatigue regardless of working height.



**Trigger-controlled miter indexing mechanism.** Facilitates quick, easy and accurate selection of 0°, 22½° and 45° R&L settings. Easy-to-read scale for in-between angles is accurate to ½ of a degree.



**Exclusive poly-v belt drive system.** Unique rear-mounted motor delivers plenty of power and speed to a separate, independent saw arbor through an extra-wide poly-v belt drive. Runs quieter; eliminates costly repairs of gear driven systems.



**Big cutting capacity.** Crosscuts a nominal 2x6 or 4x4; miter a 2x4, flat or on edge, at 45°—all in a single pass, using a 10" diameter blade and without having to adjust the fence.

## SPECIFICATIONS

<b>Motor</b> .....	12 amp., 120V, 25-60 Hz.
<b>Blade:</b>	
Diameter .....	10" (254 mm)
Arbor .....	5/8" (16 mm)
Speed .....	6000 rpm
<b>Capacity:</b>	
Crosscut Max. WxH .....	5½" x 2½" (140 x 64 mm)
Max. HxW .....	3½" x 3½" (89 x 89 mm)
Miter at 45° R&L Max. WxH .....	3⅞" x 2½" (98 x 64 mm)
Max HxW .....	3½" x 2½" (89 x 64 mm)
Miter at 22½° R&L Max. WxH .....	5" x 2½" (127 x 64 mm)
Max HxW .....	3½" x 3¼" (89 x 83 mm)

<b>Fence size R&amp;L</b> .....	2½" x 8⅝" (64 x 219 mm)
<b>Table:</b>	
Diameter .....	10⅝" (262 mm)
Sides .....	3¾" (95 mm)
<b>Miter Stops</b> .....	0°, 22½° & 45° R&L
<b>Overall Dimensions:</b>	
Height .....	24" (610 mm)
Width .....	18" (437 mm)
Depth .....	20" (508 mm)
<b>Weight</b> .....	30 lbs. (14 kg)



# 10" Compound Miter Saw

Efficiently handles bevel and compound angle cutting jobs in addition to big capacity miter and square cuts.

- Double insulated construction for operator safety.
- D-handle design with trigger switch for positive control; lock-out button to prevent accidental starts.
- Electric brake automatically stops blade in seconds.
- Built-in arbor lock for easy single wrench blade changes.
- Automatic retracting see-through blade guard.
- Dust bag to collect fine dust particles and wood chips.
- Replaceable cut-through table insert for optimum chipbreaking.

**Model 36-220 10" Compound Miter Saw.** Includes basic machine with 15 amp., 120V, 60 Hz. motor; cord with 2-prong plug; electric blade brake, 10" diameter saw blade, retractable blade guard, dust bag, work supports, clamp and stock stop, wrench and instruction manual.

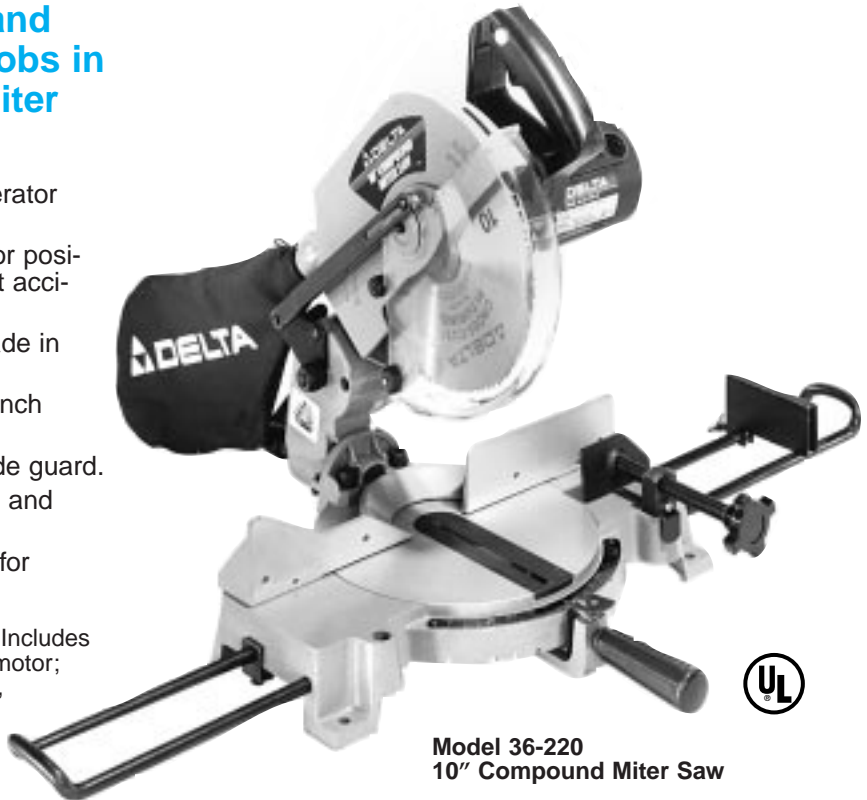

**Model 36-220  
10" Compound Miter Saw**



**Aggressive 15 amp. motor** develops plenty of power to crosscut standard 2 x 6 or 4 x 4 stock at 90°; miter a 2 x 4 at 45°.



**Bevel cuts at full 1 3/4" x 5 3/4"** at 45° blade tilt compound angle cuts 1 3/4" x 4 1/8" at its maximum 45° miter and bevel cutting position.



**Extra-wide fence** for extra support with a work clamp to securely hold the workpiece, assures accurate cutting; simplifies compound angle cutting crown moulding.



**Work supports** for cutting extra-long material, with a stock stop to facilitate repetitive cut-off work are included as standard equipment.

## SPECIFICATIONS

<b>Motor</b> .....	15 amp., 120V, 60 Hz.
<b>Blade:</b>	
Diameter .....	10" (254.0 mm)
Arbor .....	5/8" (15.8 mm)
Speed .....	4900 rpm
<b>Capacity with Fence in Front Position:</b>	
Crosscut .....	2 3/4" x 5 1/8" (70 x 130 mm) 3 1/2" x 4" (89 x 102 mm)
Miter 45° R&L .....	2 3/4" x 3 1/2" (70 x 89 mm)
Bevel 45° L .....	1 3/4" x 5 1/8" (44 x 130 mm)
Compound 45° x 45° .....	1 3/4" x 3 1/2" (44 x 89 mm)
<b>Capacity with Fence in Rear Position:</b>	
Crosscut .....	2 3/4" x 5 3/4" (70 x 146 mm) 3 1/2" x 4 5/8" (89 x 117 mm)
Miter 45° R&L .....	2 3/4" x 4 1/8" (70 x 105 mm)
Bevel 45° L .....	1 3/4" x 5 3/4" (44 x 146 mm)
Compound 45° x 45° .....	1 3/4" x 4 1/8" (44 x 105 mm)

<b>Fence Size:</b>	
Left .....	3" x 7 1/2" (76 x 191 mm)
Right .....	2 1/2" x 8" (64 x 203 mm)
<b>Table:</b>	
Diameter .....	10 1/2" (267 mm)
Sides .....	3 3/4" (95 mm)
<b>Bevel Positive Stops</b> .....	0° and 45° L
<b>Miter Stops</b> .....	0°, 15°, 22 1/2°, 30° and 45° R & L
<b>Overall Dimensions</b> .....	20 1/2" x 38 1/2" x 20 1/2" (521 x 978 x 521 mm)
<b>Weight</b> .....	49 lbs. (22 kg)



# 10" Power Miter Saw

**Power. Capacity. Portability. Everything you could ask for in a miter saw!**

- Convenient miter indexing control with positive stops at 0°, 22½° and 45° R&L. Easy-to-read scale for in-between angles is accurate to ½°.
- Extra-wide one-piece fence for maximum support of wide materials.
- See-through blade guard covers blade at all times; automatically retracts as cut is being made.
- Electric blade brake automatically stops blade in seconds.
- Pre-drilled base holes for easy bench mounting.

**Model 36-070 10" Power Miter Saw.** Includes basic machine with 13 amp., 120V, 60 Hz. motor; 6' 3-conductor cord with ground-type plug, electric blade brake, 10" dia. saw blade, retractable saw blade guard, dust bag, wrenches and instruction manual.



**Model 36-070  
10" Power Miter Saw**



**13 amp., 5200 rpm motor** provides plenty of power and speed for tough cutting jobs.



**Crosscuts a nominal 2 x 6 or 4 x 4 at 90°.** Miter a 2 x 4 flat or on edge in a single pass, at 45°.



**Constructed of a lightweight aluminum alloy**—weighs only 28 lbs. for easy carrying from job to job.

## SPECIFICATIONS

<b>Motor</b> .....	13 amp., 120V, 60 Hz.	<b>Fence Size R&amp;L</b> .....	2½" x 7⅞" (64 x 200 mm)
<b>Blade:</b>		<b>Table:</b>	
Diameter .....	10" (254 mm)	Diameter .....	11" (279 mm)
Arbor .....	⅝" (16 mm)	Sides .....	3¼" (83 mm)
Speed .....	5200 rpm	Miter stops .....	0°, 22½° and 45° R&L
<b>Capacity:</b>		<b>Overall Dimensions:</b>	
Crosscut .....	5¾" x 2¼" (146 x 57 mm)	Height .....	20¼" (514 mm)
	3¾" x 3¾" (95 x 95 mm)	Width .....	17¾" (451 mm)
Miter at 45° R&L .....	4⅞" x 2¼" (105 x 57 mm)	Depth .....	32" (81 mm)
	3½" x 3⅛" (89 x 79 mm)	<b>Weight</b> .....	28 lbs. (13 kg)



# 8 1/4" Compound Miter Saw

## The straightforward answer to angle cutting.

- Full 9 amp. motor powers through crosscuts up to 2 1/8" x 5 1/8" thick.
- Large 11" diameter table has positive ball detents at 0°, 15°, 22 1/2°, 30° and 45° right and left. Bevel scale has stops at 0° and 45° for quick setting of common compound angles.
- Nominal 15 3/4 lb. weight makes it perfect for moving around the workshop or the job site.
- Articulating blade guard continuously adjusts to cover the blade as it's raised and lowered.
- Built-in arbor lock for easy, single wrench blade changes.
- Replaceable cut-through table insert for optimum chipbreaking.
- Equipped with an electric brake that automatically stops blade in seconds.

**Model 36-040 8 1/4" Compound Miter Saw.** Includes basic machine with 9 amp., 115V, 60 Hz., universal motor, 7' cord with 2-prong plug; automatic electric blade brake, 8 1/4" diameter saw blade, retractable blade guard, dust bag and instruction manual.



**Model 36-040**  
**8 1/4" Compound Miter Saw**



**Compound angle and bevel** cutting is easy and accurate.



**Blade tilts 0° to 45° left** for bevel and compound angle cutting.



**Accurately cuts stock 2" thick** and a full 5" wide.



**Positive detents on table** facilitate miter cutting.

## SPECIFICATIONS

**Motor** ..... 9 amp., 115V, 60 Hz., AC

**Blade:**

Diameter ..... 8 1/4" (210 mm)

Arbor ..... 5/8" (16 mm)

Speed ..... 5200 rpm

**Capacity:**

Crosscut ..... 2 1/8" x 5 1/8" (54 x 130 mm)

Miter 45° R & L ..... 2 1/8" x 3 1/2" (54 x 89 mm)

Bevel 45° L ..... 1 1/2" x 5 1/8" (38 x 130 mm)

Compound 45° R & L w/45° ..... 1 1/2" x 3 1/2" (38 x 89 mm)

**Table:**

Diameter of cutting surface ..... 11" (279 mm)

Extension on sides ..... 2" (51 mm)

Bevel positive stops ..... 0° and 45° L

Miter ball detent stops ... 0°, 15°, 22 1/2°, 30° and 45° Right and Left

**Overall Dimensions** ..... 14 1/2" x 15 1/4" x 16"

(368 x 387 x 406 mm)

**Weight** ..... 15 3/4 lbs. (7 kg)

**Double insulated construction for operator safety.**

# 'kickstand Portable Work Stand

Helps make good tools even better by increasing their mobility and performance level.

- Designed to accommodate Delta Model 36-040, 36-070, 36-075, 36-090, 36-210 and 36-220 miter saws and compound miter saws. Can also be adapted to hold other bench top tools.
- Fence and table extension provide additional work support, lessening material shifting and tipping.
- Stock stop allows for repetitive cut-off and dimensioning jobs.
- Adjustable roller work supports help maintain proper stock alignment and make handling extra-long stock a one-man job.
- Rugged 13" diameter wheels maneuver easily around the job site even up and down steps.
- Portable work stand folds quickly and easily for storing or rolling to the next job.

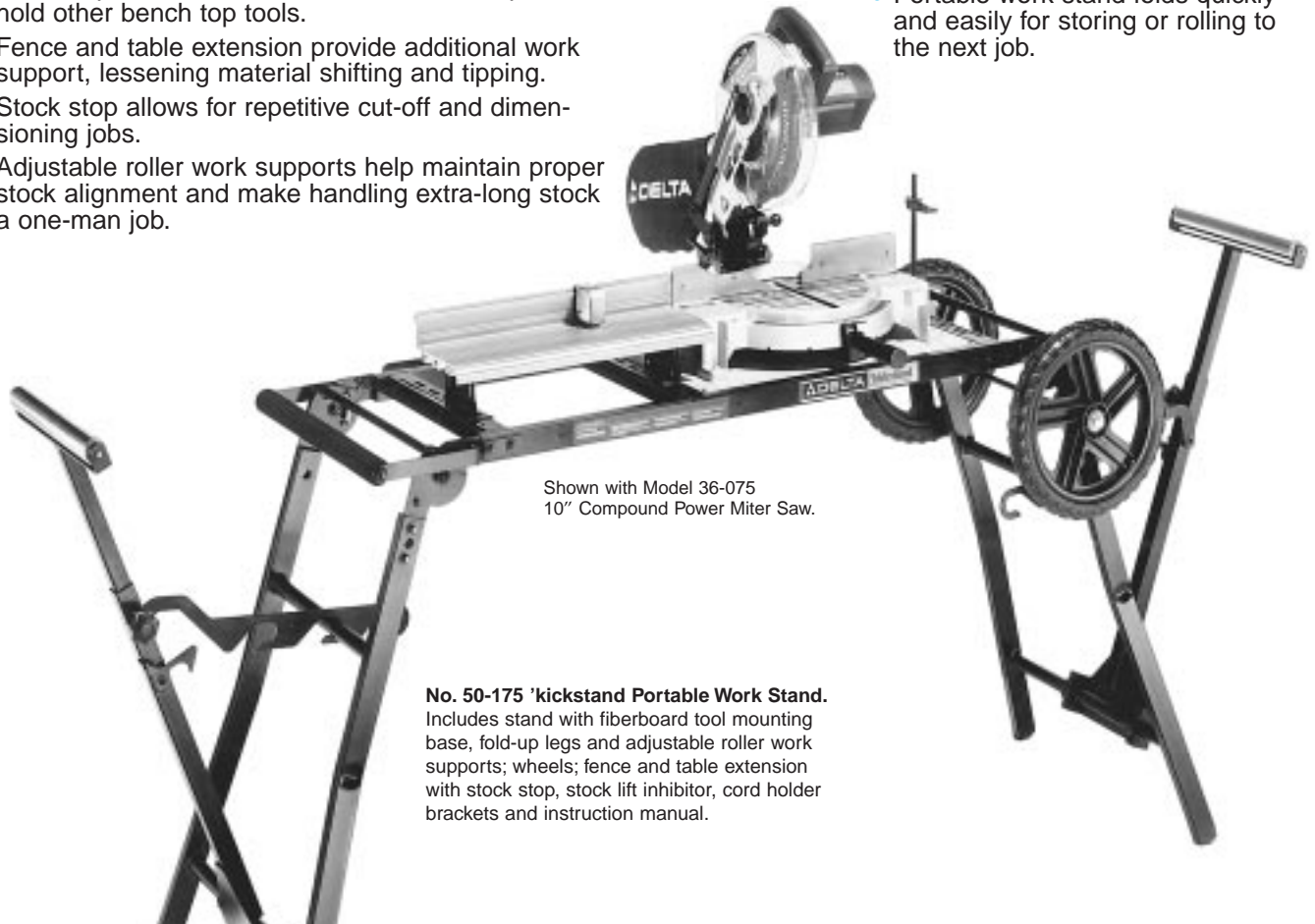

Shown with Model 36-075  
10" Compound Power Miter Saw.

**No. 50-175 'kickstand Portable Work Stand.**  
Includes stand with fiberboard tool mounting base, fold-up legs and adjustable roller work supports; wheels; fence and table extension with stock stop, stock lift inhibitor, cord holder brackets and instruction manual.



**Unique stock lift inhibitor** for safety. Prevents the cut-off workpiece from lifting up, and falling off the table, after the cut, when working with extra-long materials.



**Built-on cord holder bracket** for convenient, out-of-the-way cord storage. Bracket arm swivels for quick, easy cord removal – no unwinding necessary.



**Stock stop is included** to facilitate repetitive cut-off and dimensional jobs.



**Adjustable roller work supports** help maintain correct stock alignment; make handling extra-long materials a one-man operation.

## SPECIFICATIONS

**Overall Dimensions:**

Width ..... 114" (2896 mm)  
 Depth ..... 21" (533 mm)  
 Height ..... 42" (1067 mm)

**Weight** ..... 63 lbs. (29 kg)

# 14" Abrasive Cut-Off Saw

The saw with the mettle to handle your toughest metal-cutting jobs.

- Fold-down cutting head with locking chain and carrying handle for safe, easy transport.
- Switch can be padlocked to prevent unauthorized use.
- Extra-long 12-foot cord for on-the-job mobility
- Heavy-duty helical gear drive plus ball and needle bearing construction for smooth, efficient transmission of power.
- Heavy-duty steel base with foot pads for stable operation and less vibration.
- Full grip handle design for positive operating control.
- Built-in arbor lock for easy single wrench abrasive wheel changes.
- Sturdy metal wheel guard for operator safety.

**Model 20-140 14" Abrasive Cut-Off Saw.** Includes basic machine with 15 amp., 115V motor, 12-foot cord and grounding-type plug, work clamp, 14" abrasive wheel, wheel guard, wrench and instruction manual.



No. 20-140  
14" Abrasive Cut-Off Saw



**Powerful 15 amp. motor** provides plenty of power and speed to "gang cut" metal studs and perform other tough metal-cutting jobs.



**Work clamp secures workpiece** for operator safety; swivels 45° during angle cutting operations.



**Large 14" diameter x 1/8" abrasive wheel** cuts most types of ferrous materials; provides long-lasting performance.

## SPECIFICATIONS

<b>Motor</b> .....	15 amp., 115V, 60 Hz.
<b>Abrasive Wheel:</b>	
Diameter .....	14" (356 mm)
Arbor Hole .....	1" (25 mm)
Speed .....	3900 rpm
<b>Cutting Capacity at 90° (Using Vise):</b>	
Round .....	4 <sup>3</sup> / <sub>4</sub> " (121 mm)
Rectangular .....	2 <sup>1</sup> / <sub>2</sub> " x 9 <sup>1</sup> / <sub>2</sub> " (64 x 241 mm)
Square .....	4 <sup>1</sup> / <sub>4</sub> " x 4 <sup>1</sup> / <sub>4</sub> " (108 x 108 mm)

<b>Overall Dimensions:</b>	
Length .....	22" (559 mm)
Width .....	12" (305 mm)
Height .....	25 <sup>1</sup> / <sub>2</sub> " (648 mm)
<b>Weight</b> .....	38 lbs. (17 kg)



# 12" Radial Saw

## Built for capacity with versatility.

- Unique turret arm action permits saw blade to rotate 360° above work table.
- Built-in mechanical brake stops blade in seconds.
- The rigid channel cast iron frame and heavy column are virtually distortion-proof for perfect alignment and continued accuracy.
- Full 3¾" depth of cut at 90°, 2½" at 45° blade tilt. Crosscuts 14⅜" in a single pass.
- Precision indexing with positive stops for 90° and 45° miter cuts is precision machined for lifetime accuracy.

### Model 33-890 12" Radial Saw with 2 HP Motor for Single Phase Operation.

Includes basic machine with 230V, 60 Hz., 3450 rpm motor; on-off, key lock switch and overload protection, set of legs, automatic mechanical brake, blade guard with anti-kickback attachment, retractable leaf guard, 12" combination blade and wrenches.

### Model 33-891 12" Radial Saw with Low Voltage Control.

Same as 33-890 except with 24V at on-off, key lock switch, magnetic starter, transformer and overload protection (LVC).

### Model 33-892 12" Radial Saw with 2 HP Motor and Low Voltage Control for Three Phase Operation.

Includes basic machine with 200-230/460V, 60 Hz., 3450 rpm motor, 24V at on-off, key lock switch, magnetic starter, transformer and 3-leg overload protection (LVC), set of legs, mechanical brake, blade guard with anti-kickback attachment, retractable leaf guard, 12" combination blade and wrenches.



**Model 33-890  
12" Radial Saw**



**Unique "Turret Arm" Action.** Permits saw blade to rotate a full 360° above work table—gives full table capacity for left and right hand miters.



**Powerful Motor with Mechanical Brake.** 2 HP motor develops up to 4 HP peak under heavy workloads. Mechanical brake that's built into motor, stops blade automatically in seconds, after switch is turned off. This eliminates excessive blade coasting enabling production schedules to be maintained.

## SPECIFICATIONS

### Motor:

Horsepower ..... 2 HP  
Speed ..... 3450 rpm

### Blade:

Diameter (supplied) ..... 12" (305 mm)  
Arbor ..... ⅝"—12 L.H. Acme (16 mm)

### Capacity:

Max. depth of cut  
(less leaf guard) ..... 3¾" (95 mm)  
(with leaf guard) ..... 3¾" (95 mm)  
Dado Capacity ..... 1⅜" (21 mm)

Max. depth of cut at 45° bevel,  
(less leaf guard) ..... 2½" (64 mm)  
(with leaf guard) ..... 1¼" (32 mm)  
Crosscut ..... 14⅜" (365 mm)  
Rip ..... 24¼" (616 mm)  
Bevel Positive Stops ..... 0°, 45° and 90°  
Miter Positive Stops ..... 90° and 45° R & L  
Table Size ..... 25½" x 30" (635 x 762 mm)

**Overall Dimensions** ..... 30" x 32" x 63½"  
(762 x 813 x 1612 mm)

**Weight** ..... 300 lbs. (136 kg)

# Deluxe 10" Radial Saw

## A workshop workhorse.

- Powerful 1½ HP capacitor start motor develops up to 2¾ HP.
- Built-in automatic blade brake stops blade in seconds.
- Big 3" depth of cut at 90° and 45° miter: full 2¼" at 45° bevel.
- Rips 24" wide and crosscuts 12¾".
- Cast iron track and column support assures strength and continued accuracy.
- Up-front controls, including blade elevating crank, for greater operator convenience.
- Extra-large 24¾" x 42" table provides ample work support.
- Built-in provisions for complete adjustment and alignment of all moving parts to maintain new saw cutting accuracy for life of machine.

**Model 33-990 Deluxe 10" Radial Saw.** Includes basic machine with stand, 1½ HP, single phase, 115/230V, 60 Hz., 3450 rpm motor; automatic blade brake, 10" saw blade and blade wrenches.



**Model 33-990  
10" Radial Saw**

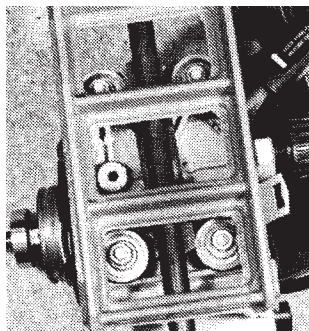

**Ball bearing roller head** for smooth cutterhead travel and effortless operation.



**Positive bevel and miter stops** at commonly used angle positions.



**Features a dual shaft** (threaded 5/8"-12LH and 1/2"-20RH) for maximum utilization of accessories.

## SPECIFICATIONS

**Motor:** ..... 1½ HP, 115/230V, 60 Hz.  
 Speed ..... 3450 rpm  
 Arbor ..... 5/8"-12 LH,  
 Rear shaft 1/2"- 20 RH

**Blade:**  
 Diameter ..... 10" (254 mm)  
 Arbor Hole ..... 5/8" (16 mm)

**Capacity:**  
 Max. depth of cut ..... approx. 3" (76 mm)  
 Max. depth of cut  
 at 45° bevel ..... approx. 2¼" (57 mm)

Crosscut ..... 12¾" (324 mm)  
 Rip ..... 24" (610 mm)  
 Dado Capacity ..... 1¾" (21 mm)  
 Bevel Positive Stops ..... 0°, 45° and 90°  
 Miter Positive Stops ..... 0°, 45° R & L  
 Table Size ..... 42" x 24¾" (1067 x 629 mm)

**Overall Dimensions:**

Width ..... 42" (1067 mm)  
 Depth ..... 37" (940 mm)  
 Height (on stand) ..... 53" (1346 mm)  
**Weight** ..... 178 lbs. (81 kg)

# Saw Fence Systems

The Delta Unifence® Saw Guide and Biesemeyer Commercial Fence Systems offer precision accuracy and large cutting capacities.

**Delta's premium five-star fences feature:**

- Easy-gliding fence body to handle quick repetitive cut-off work, precision ripping and squaring cuts.
- Three-point locking system and hairline pointer with built-in steel tape to assure fence is parallel to blade and accurate to within 1/64 of an inch.
- Ripping capability both to the right and left of blade.
- The elimination of a hand held tape.
- Universal mounting for attaching to almost any table saw.



**Delta Unifence® Saw Guide**

- Extruded, anodized aluminum construction for protection against corrosion and superior surface wear.
- Available in 30", 52" and 96" right-hand rip capacities for cutting a variety of panel sizes.
- Versatile two-position fence lets the operator use the fence two ways: vertically for normal size stock or large panel work, and horizontally for trimming laminates or ripping thin stock. Easily adjusts in seconds.

**Unifence Saw Guide.** Includes fence, carriage assembly, front guide bar, table frame, shelf support brackets (with 36-906 and 36-909 only), legs (extra set with 36-909), and mounting hardware. Less table and shelf boards.

- No. 36-905** ..... 30" Capacity
- No. 36-906** ..... 52" Capacity
- No. 36-909** ..... 96" Capacity

## SPECIFICATIONS

**Capacities:**

Rip to right ..... 30", 52" or 96" (762, 1321 or 2438 mm)  
 Rip to left ..... 8 3/4" (222 mm)

**Fence:**

Length:  
 52" and 96" systems ..... 43" (1092 mm)  
 30" systems ..... 34" (864 mm)  
 Height (vert./horiz. post) ..... 3 1/2"; 1/2" (89; 13 mm)  
 Adj. above table surface (vert./horiz. post) ..... 1/8"; 1/4" (3; 6 mm)  
 Guide bar overall length ..... 62", 83" or 128"  
 (1575, 2108 or 3251 mm)

**Scale Calibration** ..... 1/32" (.8 mm)



**Biesemeyer Commercial Fence System**

- Built to last with a combination of 9-ply Finland Birch and high-impact laminates that are hand-fitted to solid steel angle iron and tubing.
- Your choice of fence systems with 50" or 30" right-hand and 12" left-hand cutting capacity for handling most cutting jobs.
- Additional cutting capacities are available—up to 122" to the right and 48" to the left—for extra large cutting operations.

**Biesemeyer Commercial Saw Fence System.** Includes T-Square fence, front and rear guide rails, front guide tube, legs (with 78-900 and 78-904 only) and mounting hardware. For even more capacity, fence system may be special ordered with up to 122" of cutting capacity to the right of blade and up to 48" to the left.

- No. 78-900** ..... 50L12, White
- No. 78-904** ..... 50L12, Gray\*
- No. 78-910** ..... 30L12, White
- No. 78-907** ..... 30L12, Gray\*

\* Gray Biesemeyer Fence Systems feature mounting holes exclusively for Delta table saws. White Biesemeyer Fence Systems are universal and feature mounting holes for a variety of manufacturers' table saws.

## SPECIFICATIONS

**Capacities:**

Rip to right:  
 50L12 ..... 50" (1270 mm)  
 30L12 ..... 30" (762 mm)  
 Rip to left ..... 12" (305 mm)

**Fence:**

Length ..... 42" (1067 mm)  
 Height ..... 2 1/2" (64 mm)  
 Guide tube ..... 84"; 64" (1234; 1626 mm)

**Scale Calibration** ..... 1/32" (.8 mm)

## ACCESSORIES

**No. 78-940 T-Square® Auxiliary Fence.** For Biesemeyer T-Square Home Shop Saw Fence Systems. Includes fence with clamps to quickly mount fence to existing T-Square Fence Systems for moulding and shaping operations. White.



# Saw Fence Systems

Get a professional edge with the Biesemeyer Home Shop Fence System or the Delta Precision Saw Guide.



### Biesemeyer T-Square® Home Shop Fence System

- Ruggedly constructed of 9-ply Finland Birch and high impact laminates that are hand-fitted to solid steel angle iron and tubing for years of use.
- Choose from standard 28", 40" and 52" right-hand cutting capacities with 12" of left-hand capacity.
- If you need additional capacity, all home shop fence system models may be ordered with a full 24" of left-hand cutting capacity.

### Biesemeyer T-Square® Home Shop Fence System.

Includes T-Square fence, front and rear guide rails, front guide tube, legs ( 78-931, 79-012, 78-935 and 79-016 only) and mounting hardware. All home shop fence system models may be ordered with up to a full 24" of additional left-hand cutting capacity.

<b>No. 78-930</b> .....	28L12, White
<b>No. 79-010</b> .....	28L12, Gray*
<b>No. 78-931</b> .....	40L12, White
<b>No. 79-012</b> .....	40L12, Gray*
<b>No. 78-935</b> .....	52L12, White
<b>No. 79-016</b> .....	52L12, Gray*

**No. 78-941 T-Square® Auxiliary Fence.** For Biesemeyer T-Square® Home Shop Saw Fence Systems. Includes fence with clamps to quickly mount fence to existing T-Square Fence Systems for moulding and shaping operations. White.

\* Gray Biesemeyer Fence Systems feature mounting holes exclusively for Delta table saws. White Biesemeyer Fence Systems are universal and feature mounting holes for a variety of manufacturers' table saws.

## SPECIFICATIONS

### Capacities:

Rip to right:	
28L12 .....	28" (711 mm)
40L12 .....	40" (1016 mm)
52L12 .....	52" (1321 mm)
Rip to left .....	12" (305 mm)

### Fence:

Length .....	36" (914 mm)
Height .....	2½" (64 mm)
Guide tube .....	58", 70" or 82" (1473,1778 or 2083 mm)
Scale calibration .....	¼" (1.6 mm)



### Delta Precision Saw Guide

- Extruded, anodized aluminum body for corrosion resistance and long-lasting wear.
- Your choice of 29" and 50" rip capacities to the right of the blade for a variety of panel-cutting capacities.
- Easily adjustable, two-position fence allows the operator to use fence either vertically for ripping nominal size stock or horizontally for trimming laminates or ripping thin stock.

**Delta Precision Saw Guide.** Includes fence, carriage assembly, front guide rail, table frame, table support brackets, legs (No. 36-924 only) and mounting hardware.

<b>No. 36-921</b> .....	29" Capacity
<b>No. 36-924</b> .....	50" Capacity

## SPECIFICATIONS

### Model 36-921

#### Capacities:

Rip to right .....	29" (737 mm)
Rip to left .....	11" (279 mm)

#### Fence:

Length .....	32" (813 mm)
Height (vert./horiz. post) .....	2¾"; ½" (70; 13 mm)
Adj. above table surface (vert./horiz. post) .....	¼"; ⅜" (6; 10 mm)
Guide bar overall length .....	58" (1473 mm)

**Scale calibration** ..... ½" (.8 mm) up to 12", ¼" (1.6 mm) over 12"

### Model 36-924

#### Capacities:

Rip to right .....	50" (1270 mm)
Rip to left .....	11" (279 mm)

#### Fence:

Length .....	32" (819 mm)
Height (vert./horiz. post) .....	2¾"; ½" (70; 13 mm)
Adj. above table surface (vert./horiz. post) .....	¼"; ⅜" (6; 10 mm)
Guide bar overall length .....	79" (2007 mm)

**Scale calibration** ..... ½" (.8 mm) up to 12", ¼" (1.6 mm) over 12"

**To order custom Biesemeyer accessories, please call Biesemeyer Manufacturing toll-free at 1-800-782-1831 for the dealer nearest you.**

### Industrial Carbide-Tipped Circular Saw Blades

Designed, engineered and manufactured to uncompromising quality standards for optimum cutting performance and maximum service life. Check their many fine features:

- Fine-grain carbide tips, highly resistant to wear.
- Chrome alloy steel body, balanced for running accuracy.
- Expansion slots to dissipate heat; prevent warping. With copper rivet inserts to

reduce noise level. ● Tips silver brazed to body, impact tested to guarantee set. ● Tooth clearance angle precision-ground for smoothness.

### Four Popular Tooth Designs

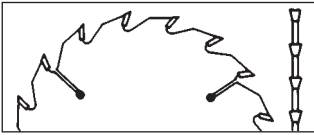

**Flat Top Grind (FT).** Generally, for cutting material with grain. Larger gullets on this type blade accept greater chip loads; permit higher feed rates. Excellent for ripping on either single or multi rip machines where speed of cut is more important than quality of cut. Teeth with square or flat top shape act as chisels, cutting material with chisel-like action. Also serve as rakers to clean out the cuttings or chips.

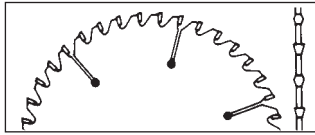

**Triple Chip & Flat Grind (TC&F).** Two shapes of teeth—alternate triple-edge and flat top design for dual action cutting. Triple-edge teeth chip down center of kerf; flat top raker teeth follow to clean out material from both sides. TC&F blades with negative hook angle are recommended for cutting non-ferrous metals. Negative hook angle prevents climbing; gives you total control over the feed rate.



**Alternate Top Bevel & Raker (ATB&R).** Excellent for cutting operations both with and/or across the grain. Achieves a fairly high level of quality over wide range of cuts. Two sets of shearing-action alternate left and right top bevel teeth followed by a raking action flat top tooth with large round gullet to facilitate chip removal.

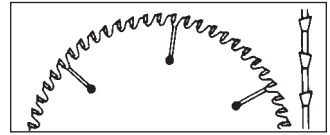

**Alternate Top Bevel Grind (ATB).** For across the grain cutting and/or cut-off and trimming operations on undefined grain work. Top bevel shaped teeth sever the material with shearing action alternately left and right. Given a choice, the ATB blade with the higher number of teeth will produce the higher quality of finish cut.

### Select the right blade with the appropriate tooth design for the material to be cut on your particular job!

To use the chart below: First refer to the proper machinery section. Next, find the blade with the highest rating under the material column that best applies to your work. If you are looking for a general purpose blade, look for consistent ratings under the materials you work with most. Or—refer to the far right hand column for the best finish rating for type of cut.

Catalog Number	Blade Description	Material													Application		
		Plate	Kerf	Hook	Bore	Hardwood	Softwood	Plywood	Compositions	1-Sided Laminates	2-Sided Laminates	Non-ferrous Metal	Tile/Asbestos	Solid Plastic	Hard Fiber/Paper	Rip	Trim Cut With Grain

#### Miter Boxes, Sawbuck, Radial Saw and Other Pendulum Type Saws

35-593	8" x 48 TC&F	.079	.110	-6°	5/8"	10	10	8	8	10	10	10	8	10	8		F	F
35-600	9" x 72 TC&F	.086	.118	-6°	5/8"	10	10	8	8	10	10	10	8	10	8		F	F
35-619	10" x 60 TC&F	.094	.118	-6°	5/8"	9	9	7	8	9	9	9	7	9	7		F	F
35-625	10" x 80 TC&F	.094	.118	-6°	5/8"	10	10	8	8	10	10	10	8	10	8		F	F
35-646	12" x 60 TC&F	.102	.126	-6°	5/8"	9	9	7	8	9	9	9	7	9	7		F	F
35-654	12" x 80 ATB	.086	.126	-6°	1"	9	9	7	9	10	10	na	na	na	8		F	F
35-655	12" x 96 TC&F	.095	.142	5°	5/8"	7	7	10	10	9	8	na	na	5	7	F	F	F

#### Circular Saws

35-590	8" x 48 TC&F	.079	.110	5°	5/8"	8	8	5	5	6	4	10	5	10	5		F	F
35-591	8" x 24 ATB/SB	.079	.118	10°	5/8"	10	10	8	8	8	5	na	na	4	4	M	M	F
35-592	8" x 64 ATB	.079	.118	8°	5/8"	6	6	10	10	9	8	na	na	7	10		M	M
35-594	8" x 48 ATB	.079	.118	5°	5/8"	7	8	8	9	10	7	na	na	na	7		M	F
35-603	9" x 24 ATB	.079	.118	15°	5/8"	8	8	8	7	7	4	na	na	na	7	M	M	M
35-604	9" x 64 ATB	.079	.118	10°	5/8"	6	6	9	10	9	8	na	na	8	10		M	M
35-606	9" x 40 ATB&R	.086	.126	15°	5/8"	10	10	8	8	na	na	na	na	na	na	M		
35-611	10" x 18 FT	.086	.118	20°	5/8"	10	10	8	8	na	na	na	na	na	na	M	F	
35-612	10" x 24 ATB/SB	.086	.126	20°	5/8"	10	10	8	8	8	6	na	na	na	5		M	F
35-613	10" x 40 ATB	.086	.126	12°	5/8"	8	8	9	9	7	6	na	na	na	na		M	M
35-614	10" x 48 ATB	.086	.126	12°	5/8"	9	9	10	10	8	7	na	na	na	na		F	F
35-616	10" x 60 ATB	.086	.126	12°	5/8"	7	8	8	9	10	7	na	na	na	7		M	F
35-617	10" x 50 ATB&R	.086	.126	15°	5/8"	10	10	8	8	na	na	na	na	na	na	F	F	F
35-618	10" x 60 TC&F	.086	.126	12°	5/8"	8	7	8	8	5	3	na	10	na	10		M	F
35-620	10" x 72 ATB	.086	.126	8°	5/8"	9	8	7	5	10	7	na	3	3	na		M	M
35-623	10" x 80 ATB	.086	.126	8°	5/8"	5	6	8	10	9	4	na	na	na	10		M	F
35-624	10" x 80 TC&F	.086	.126	10°	5/8"	5	5	7	7	9	10	na	na	10	na		F	F
35-641	12" x 24 FT	.095	.142	20°	1"	10	10	8	8	na	na	na	na	na	na	M	F	
35-642	12" x 36 ATB/SB	.095	.142	15°	1"	10	10	8	8	8	6	na	na	4	6		M	M
35-644	12" x 48 ATB	.095	.142	15°	1"	7	7	9	9	7	6	na	na	na	na		M	M
35-645	12" x 60 TC&F	.095	.142	10°	1"	10	10	10	9	10	9	na	10	na	9			
35-648	12" x 96 TC&F	.095	.142	10°	1"	5	5	7	7	9	10	na	na	10	na		F	F
35-649	12" x 96 ATB	.095	.142	10°	1"	5	6	7	10	9	4	na	na	na	9		F	M
35-656	12" x 60 ATB	.126	.173	10°	5/8"	9	9	9	8	8	7	na	na	na	8		F	F
35-657	12" x 60 ATB&R	.086	.126	15°	1"	10	10	8	8	na	na	na	na	na	na	F	F	F

#### Special High-Performance Blades (30° alternate top bevel shaped teeth) for Chip-Free Cutting of Melamine, Coreboard; Laminates and Other Man-made Materials

35-741	8" x 64 ATB	.079	.118	-6°	5/8"	6	6	10	10	10	10	na	na	na	10		F	F
35-742	10" x 80 ATB	.086	.126	-6°	5/8"	6	6	10	10	10	10	na	na	na	10		F	F
35-633	10" x 80 TC&F	.086	.126	0°	5/8"	na	na	7	10	8	8	na	na	8	8			

Blade descriptions contain the following information: the first number is the blade diameter followed by the number of saw teeth and letters indicating tooth configuration.

- FT: Flat Top Grind
- TC&F: Triple Chip & Flat Grind
- ATB: Alternate Top Bevel Grind
- ATB&R: Alternate Top Bevel & Raker
- SB: Safety Blade Design with Chip Inhibitor

The tooth designs listed above are explained in detail on the previous page.

F = Fine  
M = Medium

Ten (10) rating indicates blade works best cutting that type of material.

## Sidekick® Carbide-Tipped Circular Saw Blades



Featuring high-grade tungsten carbide tips — one of the hardest cutting materials known to man. Delta Sidekick Series blades will last up to 75 times longer than steel blades before requiring resharpening.

The tungsten carbide tips are individually brazed to high quality steel blanks, carefully checked for uniformity of fit with clearance angles precision ground for smoothness.

Each step in their manufacturing process is carefully monitored to make Delta Sidekick Series Carbide-Tipped Blades the best you can buy.

Cat. No.	Description	Plate	Kerf	Hook	Bore	Application
35-000	6 1/2" x 40 ATB	.060	.105	0°	5/8"	Sidekick Frame & Trim Saw. For cutting all types of wood when a finish cut is desired.
35-001	6 1/2" x 18 ATB	.060	.105	0°	5/8"	Sidekick Frame & Trim Saw. For fast cutting all types of wood.
35-005	6 1/2" x 18 ATB	.060	.105	15°	5/8"	Rip: For fast cutting all types of wood.
35-006	6 1/2" x 40 ATB	.060	.105	15°	5/8"	General Purpose: For cutting all types of wood when a finish cut is desired.
35-010	7 1/4" x 16 ATB	.060	.105	15°	5/8"	Rip: For fast cutting all types of wood.
35-011	7 1/4" x 24 ATB	.060	.105	20°	5/8"	Combination: For cutting all types of wood when a fine cut is desired.
35-012	7 1/4" x 40 ATB	.060	.105	15°	5/8"	Crosscut: For cutting all types of wood when a finish cut is desired.
35-021	8" x 40 TC&F	.070	.110	0°	5/8"	Sawbuck, Miter & Radial Saw: For cutting all types of wood, plastics & non-ferrous metals.
35-020	8 1/4" x 24 ATB	.060	.105	15°	5/8"	Combination: For cutting all types of wood when a fine cut is desired.
35-025	8 1/4" x 18 ATB	.060	.105	15°	5/8"	Rip: For fast cutting all types of wood.
35-026	8 1/4" x 32 ATB	.060	.105	15°	5/8"	Combination: For cutting all types of wood when a fine cut is desired.
35-027	8 1/4" x 35 ATB&R	.070	.110	15°	5/8"	Combination: For cutting all types of wood when a fine cut is desired.
35-030	10" x 30 ATB	.070	.125	15°	5/8"	Rip: For fast cutting all types of wood.
35-031	10" x 40 ATB	.070	.125	15°	5/8"	Combination: For cutting all types of wood when a fine cut is desired.
35-040	10" x 40 ATB	.070	.125	0°	5/8"	Miter Saws & Radial Saw. For cutting all types of wood, plastics & non-ferrous metals.
35-032	10" x 50 ATB&R	.070	.125	15°	5/8"	Combination: For cutting all types of wood when a fine cut is desired.
35-033	10" x 60 ATB	.070	.125	10°	5/8"	Crosscut: For cutting all types of wood when a finish cut is desired.
35-034	10" x 60 TC&F	.070	.125	0°	5/8"	Miter Saws & Radial Saw. For cutting all types of wood, plastics & non-ferrous metals.
35-035	10" x 80 ATB	.070	.125	10°	5/8"	Finish: For cutting all types of wood when a finish cut is desired.
35-056	12" x 40 ATB	.135	.090	15°	1"	Sidekick 12" Compound Miter Saw. For rough framing all types of wood.
35-058	12" x 72 ATB	.135	.090	5°	1"	Sidekick 12" Compound Miter Saw. For cutting all types of wood when a finish cut is desired.

\* With Diamond Knockout

## Dado Head Sets

Recommended For:	Catalog No.	Description	Size Outside Blades	Size Inside Chippers	Arbor Dia.	Capacity
10" Bench Saw	36-515	Dado Head Set	(2) Hollow Ground 6" dia. x 1/8" thick	(1) 1/8" thick (2) 1/16" thick	5/8"	1/8" - 1/2"
 Sidekick® 8 1/4" Builder's Saw 8 1/4" Builder's Saw Deluxe Sawbuck 10" Tilting Arbor Saw 10" Contractor's Saw 10" Contractor's Saw II 10" Deluxe Radial Saw 10" Table Saw	34-334	Economy Dado Set	(2) Flat Ground 6" dia. x 1/8" thick	(4) 1/8" thick (1) 1/16" thick	5/8"	1/8" - 13/16"
	35-550	Carbide-Tipped Dado Head Set	(2) Carbide-Tipped 6" dia. x 1/8" thick	(4) 1/8" thick (1) 1/16" thick	5/8"	1/8" - 13/16"
	35-530	Carbide-Tipped Dado Head Set Anti-Kickback Design	(2) Carbide-Tipped 6" dia. x 1/8" thick	(4) 1/8" thick (1) 1/16" thick	5/8"	1/8" - 13/16"
	35-535	Carbide-Tipped Anti-Kickback Design Dado Head Set	(2) Carbide-Tipped 8" dia. x 1/8" thick	(4) 1/8" thick (1) 1/16" thick	5/8"	1/8" - 13/16"
10" Deluxe Radial Saw 12" Radial Saw	35-535	Carbide-Tipped Anti-Kickback Design Dado Head Set	(2) Carbide-Tipped 8" dia. x 1/8" thick	(4) 1/8" thick (1) 1/16" thick	5/8"	1/8" - 13/16"
Most 10" Circular Saws* Including XL-10 Table Saw	35-825	Carbide-Tipped Adjustable Dado	7" diameter		5/8"	1/4" - 13/16"

\*Not recommended for the Deluxe Sawbuck, 8 1/4" Builder's Saw or the Sidekick® 8 1/4" Builder's Saw.

## Table Inserts

Model	Standard	Dado	Moulding	Model	Standard	Dado	Moulding
10" Tilting Arbor Saw	34-154	34-254*	34-453	10" Table Saw	34-678	34-672	34-673
10" Contractor's Saw	34-154	34-254*	34-453	Sidekick 8 1/4" Builder's Saw	36-278	36-276	—
10" Contractor's Saw II	34-154	34-254*	34-453	10" Bench Saw	36-516	36-517	—
XL-10 Table Saw	34-678	34-672	—				

\* Replace No. 34-254 with No. 34-264 Dado Insert for 7" and 8" Dados.

## Sanding Attachments, Discs and Sleeves

Recommended For:	Cat. No.	Sanding Attachments	Cat. No.	Sanding Discs and Sleeves
All 10" Circular Saws	34-574	9" Dia. Sanding Disc Attachment, 5/8" Arbor	34-588	Self Adhesive 9" Dia. Sanding Discs, (2) 60G Coarse and (2) 120G Fine
Deluxe 10" Radial Saw	33-853	Sanding Drum Attachment 3" Dia. x 3", 1/2"—20 RH Thread (Includes (1) Sleeve)	46-103 46-104 46-105	3" Dia. x 3" Abrasive Sleeve, (1) 40G Coarse, Garnet 3" Dia. x 3" Abrasive Sleeve, (1) 50G Coarse, Garnet 3" Dia. x 3" Abrasive Sleeve, (1) 50G Coarse, Aluminum Oxide
	33-854	Sanding Drum Attachment 1 3/4" Dia. x 2", 1/2"—20RH Thread (Includes (1) Sleeve)	46-106 46-107	1 3/4" Dia. x 2" Abrasive Sleeve, (1) 40G Coarse, Garnet 1 3/4" Dia. x 2" Abrasive Sleeve, (1) 60G Medium, Garnet



## Moulding Cutterhead Knives

Can be used with all Delta Moulding Cutterheads

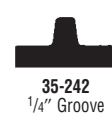
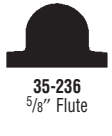
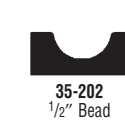
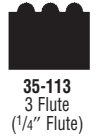
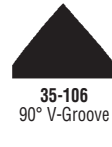

## Moulding Cutterhead Sets

	Recommended for:	Catalog Number	Description	Dia.	Arbor	Arbor w/ bushing	Includes:
	10" Tilting Arbor Saw	34-562	Moulding Cutterhead	4"	5/8"	1/2"	Cutterhead only
	10" Contractor's Saw	34-821	Basic Moulding Cutterhead and Knife Set	4"	5/8"	1/2"	34-562 Cutterhead, 34-521 Wrench and 35-102 Set of Knives
	10" Contractor's Saw II 10" Table Saw 10" & 12" Radial Saws	34-813 (shown)	Heavy Duty Moulding Cutterhead and Knife Set	4"	5/8"	1/2"	34-562 Cutterhead, 34-521 Wrench 35-102, 35-103, 35-221 and 35-222 Cutterhead Knives

## Tenoning Accessories



**No. 34-182 Tenoning Jig.** Simplifies cutting tenons and other wood joints on your table saw. Fits left and right-tilting table saws with

- 3/8" x 3/4" miter gage grooves. Handles stock up to 3 1/4" thick.
- Full grip-feed handles for positive operating control; user safety
- Adjustable 90° positive stop for accurate repetitive cuts
- 90° to 45° back stop with adjustable 90° positive stop for secure support of angular stock
- Multi-position control levers for convenient easy adjustment; better locking leverage
- Extra-large crank handle for fast, easy clamping of work

- Width-of-cut control with fine thread adjustment knob and adjustable positive stop for precision accurate settings and cutting repeatability
  - Built-in provisions for adjustment and alignment to maintain cutting accuracy
- No. 34-172 Tenoning Attachment.** Simplifies operation of cutting tenons for mortise and tenon joints. Stock can be fed with one hand—far removed from saw blade(s). Handles stock up to 2 3/4" thick. Base plate included. 30 lbs.

## Roller Table and Roller Stands

Auxiliary work supports for handling large panels, long and wide stock on table saws, radial saws, jointers, planers and other machines.

### No. 50-299 Roller Table.

With five 1 1/2" dia. x 12" ball bearing supported rollers. Adjustable in height from 25" to 42 1/2". Features base leveling screws for stable four-point contact. Adequately supports up to 250 lbs.

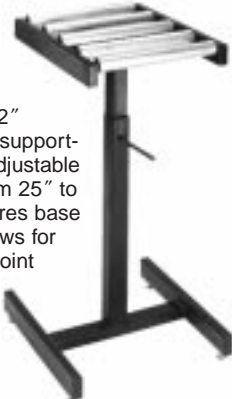

### No. 50-298 Roller Stand.

With 1.9" dia. x 12" ball bearing supported roller and dual widely-spaced base structure for stability. Adjustable in height from 25" to 42 1/2". Folds flat for storage. Adequately supports up to 250 lbs.



### No. 34-632 Roller Stand.

Full 2 1/2" dia. x 17 1/2" roller. Adjustable in height from 26 1/4" to 43 1/2". Four-footed cast-iron base for stability. Adequately supports up to 200 lbs.

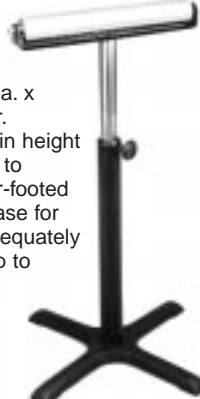

### No. 50-300 Roller Stand.

Full 1 1/4" dia. x 12" ball bearing supported roller. Adjustable in height from 24" to 43 1/2". Folds flat for storage. Adequately supports up to 200 lbs.



## Deluxe Uniguard® Blade Guard System With Splitter and Anti-Kickback Fingers



**No. 34-976 Uniguard® Blade Guard.** Fits Delta 10" Tilting Arbor Saw (shown), Delta Unisaw and Delta 10" Contractor's Saws with 30" or 52" Unifence Saw Guide or just about any other table saw.

- Fixed splitter maintains correct alignment with saw blade at all times. Tilts with saw arbor for angle cutting.
- Removable splitter for non-thru cutting; permits cut-through operations without removal.
- Clear see-through Lexan® split basket shields.

**No. 34-976 Uniguard® Blade Guard.** With splitter and anti-kickback fingers. Includes table mounting bracket, support arm with extension, basket arms, Lexan® shields, switch support arm, lamp mounting bracket, storage basket and push stick and instruction manual.

**No. 78-953 Uniguard Strap Kit.** Kit replaces the rear angle rail of Biesemeyer 30" and 50" Commercial Fence Systems and Home Shop Fence Systems up to 52" for mounting the Delta Uniguard Blade Guard. Mounting hardware included.

## Biesemeyer T-Square® Table Saw BladeGuard System

**No. 78-960 Biesemeyer T-Square® BladeGuard System.** Compatible with Biesemeyer 50L12 Nos. 78-900, 78-904, 78-935 and 79-016 saw fence systems. Fits fence systems 40" to 62".



- Permits cut-through operations without removal.
- Ceiling mounted and floor mounted models also available.

**NOTE:** For fence systems over 62", BladeGuard systems may be custom ordered. Call Biesemeyer Manufacturing toll-free at 1-800-782-1831 for the dealer nearest you.

**No. 78-960 Biesemeyer T-Square® BladeGuard System.** With T-arm assembly, blade guard, splitter, installation bracket, mounting hardware and instruction manual.

**No. 78-955 Biesemeyer T-Square® BladeGuard System.** Same as 78-960 except for fence systems 40" and under.

**No. 78-954 Biesemeyer Plate for Unifence.**

Allows you to mount the Biesemeyer No. 78-955 or 78-960 BladeGuard System to either the Delta 30" or 52" Unifence. Plate is designed to fit newer square table support legs only.

**No. 78-966 Biesemeyer Dust Collection Kit.** Use with 78-960 or 78-955 Biesemeyer T-Square systems to provide dust collection capability to tablesaws. Clear Lexan provides the operator with a view of the entire work area from all angles.

## For 10" Circular Saws



**No. 34-555 Sliding Table Attachment.**

Increases the job capacity of Delta Unisaws, 10" Tilting Arbor Saws, 10" Contractor's Saws and Heavy Duty Wood Shaper. Handles stock up to 25½" wide with the fence at 90°; 28" wide with the fence at 45° and 36" wide when fence is placed at the rear of the machine. Includes adjustable stock stop. 78 lbs.

**No. 50-302 Outfeed Table.** Two-piece laminated table provides added support for maintaining proper stock alignment and preventing material shifting and tipping. Includes 31" x 34" folding table and outboard leg that fold out of the way when not in use. Fits Delta Unisaw® Tilting Arbor Saws and may be easily adapted to fit most other comparable cabinet-type table saws. Mounting hardware included.

**No. 34-171 Spacer Collars.** Set of two: ¼" and ⅜" widths with ⅝" arbor hole. For spacing-saw blades to cut tenons in one pass. 1 lb.

**No. 34-779 Miter Gage.** For straight and angle work. Has ⅜" x ¾" x 18" guide bar. Adjustable positive stops at 90° and 45° positions. Accommodates No. 34-568 Clamp Attachment.

**No. 34-895 Auto-Set® Miter Gage.** For straight and angle operations. Has ⅜" x ¾" x 18" guide bar and pivoting work support with pointer and calibrations reading through 120° swing. Adjustable, positive stops at 90° and 45° positions. Accommodates No. 34-568 Clamp Attachment. 3½ lbs.

**No. 34-568 Clamp Attachment for Miter Gage.** Holds work securely for accurate miter and cut-off operations. Complete with clamp bar, front and rear posts and two sliding clamp screws and blocks. For use with No. 34-895 Miter Gage. 1½ lbs.

**No. 34-873 Extra Clamp Screw and Block Only.** For use with No. 34-568 Clamp Attachment ½ lb.

## For 10" Tilting Arbor Saw

**No. 78-962 Biesemeyer T-Square® Anti-Kickback Snap-In Spreader.** Complete with spring-loaded anti-kickback fingers. 6 lbs.

† **No. 50-278 Mobile Base.** Adds roll-away portability to 10" Tilting Arbor Saw.

† **NOTE:** For 10" Tilting Arbor saw equipped with 52" Unifence Saw Guide, also order No. 50-284 Mobile Base Extension. For saws equipped with 30" Unifence Saw Guide, also order No. 50-285 Base Extension

## For 10" Contractor's Saw®, 10" Contractor's Saw® II & 10" Tilting Arbor Saw

**No. 34-914 Table Board.** For 36-905 Unifence. With laminate coating. Size 27" x 32".

**No. 34-998 Table and Shelf Boards.** For use with 36-906 52" Unifence. 27" x 48". Laminated.

**No. 36-624 Table Board.** For use with No. 36-905 30" Unifence. 27" x 32" Medium density fiberboard.

**No. 34-878 Cut-Off Fence.** 10½" long for repetitive cut-off work.

**No. 36-625 Table Board and Shelf.** For use with No. 36-924 50" Precision Saw Guide. Large 27" x 48" table.

**No. 36-907 52" Unifence Rail.**

**No. 36-908 52" Unifence Less Rail.**

**No. 36-925 Table Board.** For use with No. 36-921 29" Precision Saw Guide. Measures 27" x 30".

**No. 36-926 Fence Leg Assembly.** Provides extra support for No. 36-925 table.

**No. 78-951 Adjustable Steel Support Legs.** Provides extra support for extension table. White.

**No. 78-952 Adjustable Steel Support Legs.** Same as above, except in gray.

**No. 78-929 Right Extension Table.** For use with No. 78-930 and 79-010 Biesemeyer 28" T-Square® Home Shop Fence Systems. 27" x 22". White.

**No. 43-349 Single Cast Iron Extension Wing.** Single solid cast iron extension wing measures 27" x 8". Attaches to either side of table.

**No. 34-545 Cast Iron Extension Wing Pair.** A set of two solid cast iron extension wings. Each wing measures 27" x 8".

### For 10" Contractor's Saw®, 10" Contractor's Saw® II & 10" Tilting Arbor Saw (cont'd)

**No. 78-934 Right Extension Table.** For use with No. 78-931 and 79-012 Biesemeyer 40" T-Square® Home Shop Fence Systems. 27" x 34". White.

**No. 78-938 Right Extension Table.** For use with No. 78-935 and 79-016 Biesemeyer 52" T-Square® Home Shop Fence System. 27" x 46". White.

**No. 78-928 Rear Support Table.** Adds an additional 4' x 4' of work support. White.

**No. 78-925 Right Extension Table.** For use with No. 78-900 and 78-904 Biesemeyer 50" T-Square® Commercial Fence Systems. 27" x 44". White.

**No. 78-927 Right Extension Table.** For use with No. 78-907 Biesemeyer 30" Commercial Fence System. 27" x 24" White.

**No. 34-472 Extra Long Guide Bars.** Permit ripping to center of 100" panel. 22 lbs.

**No. 34-896 Aluminum Body Jet-Lock® Micro-Set® Rip Fence.** 20 lbs.

**No. 34-412 "See-Thru" Splitter-Mounted Blade Guard.** Complete with spring-loaded anti-kickback fingers. 6 lbs.

**No. 36-659 Arbor Nut Assembly.** Two-piece arbor nut set provides convenient installation and removal of the flange and arbor nut.

### For 10" Contractor's Saw® & 10" Contractor's Saw® II



**No. 50-176 Dust Bag.**

Mounts easily to the underside of Delta 10" Contractor's Saw and 10" Contractor's Saw II for collecting dust and chips.

**No. 50-390 Outfeed Support Table Kit.** For Delta 34-444 and 34-445 10" Contractor's Saws. Includes mounting hardware and instructions for assembling your own folding outfeed support table. Less Support table.

**No. 50-393 Outfeed Support Table Board.** For use with 50-390 Outfeed Support Table Kit. Table board provides an additional 15<sup>3</sup>/<sub>4</sub>" of work support. Medium density fiberboard.

### For 10" Contractor's Saw®

**No. 34-965 Belt Guard.** Encloses entire V-belt and motor pulley, preventing small pieces of stock from striking and damaging the belt or pulley during operation. 4 lbs.

**No. 78-963 Biesemeyer T-Square® Anti-Kickback Snap-In Spreader.** Complete with spring-loaded anti-kickback fingers. 6 lbs.

### For 10" Contractor's Saw® (cont'd)



**No. 34-278 Switch Kit.** Replaces toggle switch with large, up-front paddle switch.

**No. 50-220 Dust Connector.** Attaches to underside of saw mounted to No. 50-314 Stand. 5" dia. outlet. Includes mounting screws.

† **No. 50-277 Mobile Base.** Adds roll-away portability to 10" Contractor's Saw.

† **NOTE:** For saws equipped with 30" Unifence Saw Guide, also order No. 50-285 Mobile Base Extension.

### For 10" Contractor's Saw® II

**No. 36-633 Dust Collector Connector.** Mounts directly to saw carriage. 4" dia. outlet.

**No. 36-634 Mounting Hook Kit.** Includes brackets to hold miter gage, rip fence and wrenches.



† **No. 50-286 Mobile Base.** Adds roll-away portability to 10" Contractor's Saw II.

**No. 78-964 Biesemeyer T-Square® Anti-Kickback Snap-In Spreader.** Complete with spring-loaded anti-kickback fingers. 6 lbs.

† **NOTE:** For saws equipped with 30" Unifence Saw Guide, also order No. 50-285 Mobile Base Extension.

### For 10" Table Saws (36-600 and 34-670)



**No. 50-391 Outfeed Support Table Kit.** Includes mounting hardware and instructions for assembling your own folding outfeed support table. Less Support table.

**No. 50-394 Outfeed Support Table Board.** For use with 50-391 Outfeed Support Table Kit. Table board provides an additional 14" of work support. Medium density fiberboard.

**No. 36-601 T-Square Fence System.** Upgrade your Model 34-670 10" Table Saw with our newest precision fence system. Includes rails and mounting hardware.

**No. 50-279 Mobile Base.** Adds roll-away portability to 10" Table Saws.

### For Sidekick® 8<sup>1</sup>/<sub>4</sub>" Builder's Saw®

**No. 36-276 Dado Head Table Insert.**

**No. 36-277 Steel Stand.** Converts bench saw to floor model machine.

**No. 36-278 Table Insert.**

**No. 36-279 Extension Kit.** Includes one 6<sup>1</sup>/<sub>4</sub>" x 20" extension wing with for use on the right or left side. With mounting hardware.

### For 10" Table Saw (34-670)

**No. 34-674 Drive Belt.** For replacement use on model 34-670 10" Table Saw.

### For 10" Bench Saw



**No. 36-541 Extension Kit.** Includes one 16" x 8" die cast aluminum extension wing with mounting hardware to increase work support surface to a full 17<sup>1</sup>/<sub>4</sub>" x 34".



**No. 36-519 Steel Stand.** Converts bench saw to table saw height of 39".

### For All Table Saws

**No. 11-400 Getting the Most Out of Your Table Saw.** Contains a wealth of information – the many jobs you can handle, types of operations that can be performed using accessories, safety considerations and lots more.





### For Sidekick® Frame & Trim Saw

**No. 33-059 Table Extension.** With mounting parts. Facilitates cutting extra-long stock.

**No. 33-058 Work Clamp.** Securely holds work for more accurate cutting.

### For Sidekick® Motorized Miter Box

**No. 36-092 Drive Belt.** For replacement use.



**No. 36-221 Work Clamp.** Securely holds work for more accurate cutting.

**No. 50-330 Universal Stand.** Converts unit to floor model machine.

**No. 50-287 Mobile Base.** Adds roll-away portability to stand-mounted machine.

### For 10" Power Miter Saw and 10" Compound Power Miter Saw

**No. 36-221 Work Clamp.** Securely holds work for more accurate cutting.

### For 10" Motorized Miter Box

**No. 34-085 Drive Belt.** For replacement use on 10" motorized miter box.

**No. 34-084 Dust Bag.** Collects fine wood dust and chips.

### For Deluxe Sawbuck® Frame and Trim Saw

**No. 33-052 3-Ft. Fence Extension & Support.**

**No. 33-053 Leg Set.** Included as standard equipment with 33-055 Sawbuck. Includes fold-up legs with two 7<sup>5</sup>/<sub>16</sub>" dia. wheels and mounting hardware.

### For 8<sup>1</sup>/<sub>4</sub>" Compound Miter Saw

**No. 36-044 Dust Bag.** Collects dust and chips.

**No. 50-330 Universal Stand.** Converts unit to floor model machine.

**No. 50-287 Mobile Base.** Adds roll-away portability to 50-330 stand-mounted machine.

### For 10" Compound Miter Saw

**No. 36-222 Dust Bag.** Collects dust and chips.

### For 14" Abrasive Cut-Off Saw

**No. 20-152 14" Dia. x 7<sup>1</sup>/<sub>64</sub>" Abrasive Cut-Off Wheels.** 1" arbor hole. Reinforced type. For cutting ferrous metal materials. Package of 5.

### For 10" and 12" Miter Saws & 10" Slide Saws

**Biesemeyer® T-Square® Miter Saw Table Systems.** Make most motorized miter saws more accurate and productive.



**No. 78-802 2' Miter Table.** For 10" Miter Saws.

**No. 78-804 4' Miter Table.** For 10" Miter Saws.

**No. 78-806 6' Miter Table.** For 10" Miter Saws.

**No. 78-808 8' Miter Table.** For 10" Miter Saws.



**No. 79-803 3' Miter Table.** For 12" Saws & 10" Slide Saws.

**No. 79-804 4' Miter Table.** For 12" Saws & 10" Slide Saws.

**No. 79-806 6' Miter Table.** For 12" Saws & 10" Slide Saws.

**No. 79-808 8' Miter Table.** For 12" Saws & 10" Slide Saws.

**No. 78-990 Outside/Cut-off Miter Stop.** For precision cutting to the outside of the miter. Dual hairline pointer.

**No. 78-994 Inside/Cut-off Miter Stop.** For precision cutting to the inside of the miter. Dual hairline pointer.

### For 10" and 12" Miter Saws, 10" Sliding Compound Miter Saws and 10" and 12" Radial Saws

**Biesemeyer® T-Square® Precision Table Sets.** Feature 8' of cutting capacity to the left and 6' to the right.

**No. 78-980 Table Set.** 12" table width.

**No. 78-981 Table Set.** 16" table width.



**No. 78-989 Biesemeyer® T-Square® Dual Pointer Cut-Off Saw Stop.** Precise to 1/64th inch.

### For 10" and 12" Miter Saws, 10" Sliding Compound Miter Saws and 10" and 12" Radial Saws

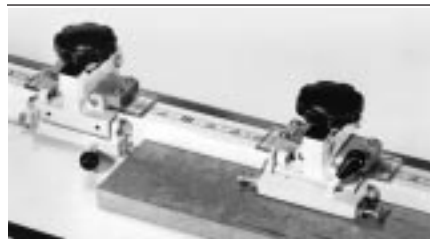

**No. 78-992 Biesemeyer® T-Square® Dual Pointer Flip Stop.** For repetitive cutting operations. Fits any standard 1<sup>5</sup>/<sub>8</sub>" high fence.

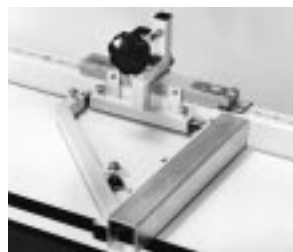

**Biesemeyer® T-Square® Cut-Off Gang Stops.**

**No. 78-987.** For 12" table width.

**No. 78-988.** For 16" table width.

**No. 33-594 Retractable Leaf Guard.** For 12" blade guard. 2 lbs.

**Adhesive-Backed Measuring Tapes.**

Easy-to-read 12-ft. and 6-ft. tapes are designed for use with Biesemeyer T-Square Universal Miter Saw Table Systems, Cut-Off Saw Stops, Flip-Stops and Cut-Off Gang Stops. Available in English only or English/Metric versions that read right-to-left or left-to-right.

Cat. No.	Description
79-056	12' R 1/2" English/Metric*
79-057	12' L 1/2" English/Metric*
79-061	12' R 1/2" English
79-062	12' L 1/2" English
79-064	12' R 3/4" English/Metric*
79-065	12' L 3/4" English
79-066	12' R 3/4" English
79-067	6' R 3/4" English/Metric*
79-068	6' R 3/4" English
79-069	6' R 1/2" English
79-070	6' L 1/2" English
79-071	6' L 1/2" English/Metric*
79-072	6' R 1/2" English/Metric*

\* English/Metric Tapes cannot be used in conjunction with No. 78-990 and 78-994 T-Square inside and outside miter stops.

### For 10" and 12" Radial Saws

**No. 33-619 One 4 ft. long roller extension table with four 18" rollers.** Increase the length of infeed or outfeed tables. Your material always moves in a straight line on a level table.

**No. 33-967 Moulding/Shaping Guard.** For use when shaping or moulding on 12" radial saw.

**No. 33-851 Shaper Cutter Adapter.** 5/8"—12 LH thread. For mounting 1/2" hole. For 1/2" hole, 3-lip shaper cutters.

**No. 50-283 Mobile Base.** Adds roll-away portability to 10" Radial Saw mounted on 33-972 steel legs.

**No. 33-551 Cutterhead Return Attachment.** Helps speed up production. Returns cutterhead automatically out of the way, behind guide fence after cut. 4 1/4 lbs.

**No. 11-403 Getting the Most Out of Your Radial Saw Book.** With a special chapter on the Motorized Miter Box.