



[COMPOSITIONS][™]
O V E R T U R E

Model OVTR 1
3-Way Full-Range Bookshelf Speakers

Owner's Manual

OVTR 1 Part #331252-001 – 120 Vac Only



	CAUTION RISK OF ELECTRIC SHOCK DO NOT OPEN	
<p>CAUTION: TO REDUCE THE RISK OF ELECTRIC SHOCK, DO NOT REMOVE COVER (OR BACK). NO USER-SERVICEABLE PARTS INSIDE. REFER SERVICING TO QUALIFIED SERVICE PERSONNEL.</p>		

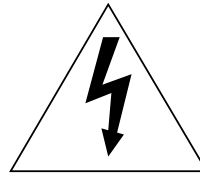

The lightning flash with arrowhead symbol, within an equilateral triangle, is intended to alert the user to the presence of uninsulated “dangerous voltage” within the product’s enclosure that may be of sufficient magnitude to constitute a risk of electric shock to persons.



The exclamation point within an equilateral triangle is intended to alert the user to the presence of important operating and maintenance (servicing) instructions in the literature accompanying the product.

THIS INFINITY PRODUCT IS DESIGNED FOR (USA) 120 VOLT USE ONLY! FOR DETAILED SAFETY PRECAUTIONS, PLEASE SEE THE ENCLOSED LEAFLET “IMPORTANT SAFETY INSTRUCTIONS” (P/N 330100-001).

**OVTR 1
Front**

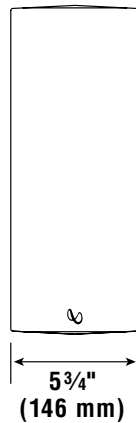

**OVTR 1
Side**

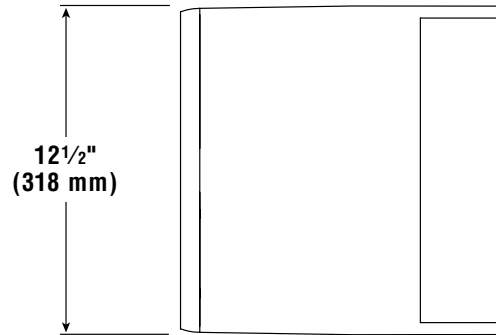

**OVTR 1
Top**

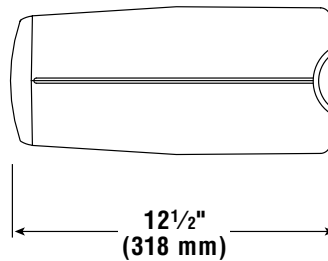

COMPOSITIONS OVERTURE
OVTR 1
OVERALL DIMENSIONS

3-WAY BOOKSHELF SPEAKERS WITH INTEGRATED POWERED SUBWOOFERS...

ABOUT THIS MANUAL...

PARTS LIST...

TOOLS AND SUPPLIES (NOT ENCLOSED)...

INTRODUCTION

The Infinity Compositions Overture OVTR 1 speaker system is a super-compact, 3-way, full-range bookshelf or stand-mounted speaker with an integral powered subwoofer. The OVTR 1 is ideal for use where space is at a premium. With its wide bandwidth and uniform response, it excels in the accurate reproduction of music, but its high efficiency and ability to produce realistic sound levels with minimal amplifier power make it equally suited for use in the finest home theater system.

To start enjoying your new pair of Compositions Overture OVTR 1 speakers, first read and then perform all instructions listed in this manual, as well as those found in the owner's manuals of associated components in your audio system. Also, please read the enclosed Important Safety Instructions for detailed safety precautions. Save all instructions for future reference. These speakers are covered by a limited five-year warranty (see the back cover), so save the bill of sale to protect your purchase and aid in any service-related questions.

UNPACKING THE SPEAKERS

Finish unpacking the speaker box. Be careful lifting the speakers, since they are heavier than they appear. If you suspect damage from transit, report it immediately to your dealer and/or delivery service. Keep the shipping cartons and packing materials for future use. Open the accessory pack and verify the following contents:

- ◆ (2) Molded Feet (For Vertical Placement)
- ◆ (4) Small Self-Adhesive Feet (For Horizontal Placement)
- ◆ (4) Large Self-Adhesive Feet (For Horizontal Placement)
- ◆ (2) Grilles
- ◆ (4) Spare 2AG 3A SB 250V Fuses
- ◆ Owner's Manual (P/N 331214-001) and Warranty Registration Card

You may also need the following tools and supplies:

- ◆ High-quality speaker wire (also see *Wiring The System* on page 6)
- ◆ Wire strippers
- ◆ Small flat-blade screwdriver (for fuse replacement, if needed)
- ◆ Spade terminals (optional)

PLANNING YOUR SYSTEM

STEREO PLACEMENT...

Before deciding where to place your Compositions Overture OVTR 1 speakers, survey your room and keep the following points in mind:

- ◆ The OVTR 1 includes a side-firing woofer that requires a minimum 2" (25mm) clearance from an object, shelf, or wall, whether placed vertically or horizontally, on a bookshelf or stand (see Figure 1).

NOTE: The stand must be large enough to fully support the speaker.

- ◆ For vertical placement, make sure the woofers are facing toward or away from each other. For stability, install the enclosed feet (see *Installing Feet and Grilles* on page 5).
- ◆ For best results, try placing the speakers closer together than the distance to the listening area.
- ◆ Refer to Figure 2 when placing speakers for best bass level and stereo image (also see *Operating The System* on page 7).

Figure 1. Compositions Overture OVTR 1 speakers can be positioned vertically or horizontally for placement on a shelf or stand. Make sure the side-firing woofer is at least 2" away from an adjacent object, shelf, or wall.

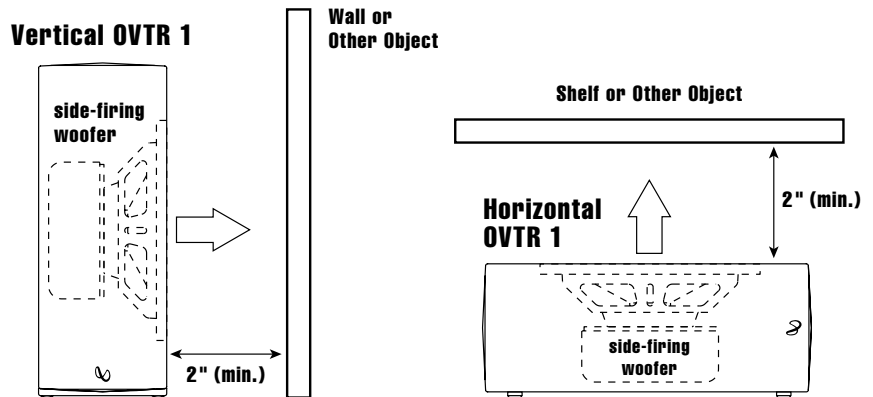
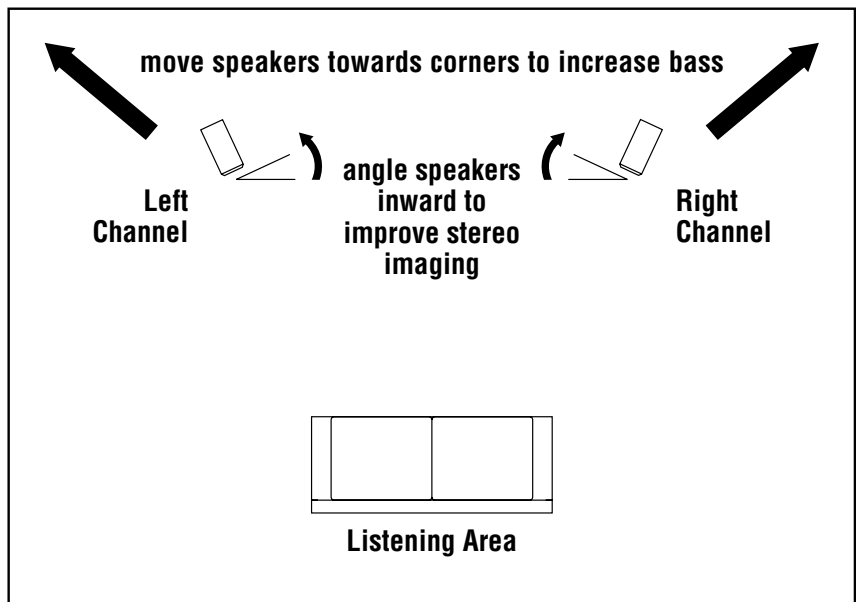

Figure 2. Experiment with speaker placement to obtain the best bass level and stereo imaging in your room.



HOME THEATER PLACEMENT...

PLANNING YOUR SYSTEM (CONT'D)

Compositions Overture OVTR 1 speakers are also suitable for use in reproducing home theater sound, as shown in Figure 3:

- ◆ For front left and right channels, place one OVTR 1 speaker on the left and another on the right, on bookshelves or stands, along either side of the television monitor.
- ◆ For surround left and right channels, place one OVTR 1 speaker on the left and another on the right, on bookshelves or stands, behind the listening area.
- ◆ For center channel use, place one OVTR 1 speaker in the horizontal position on top of or below the television monitor.
- ◆ Since the speakers are magnetically shielded, you can set them in very close without worrying about the field distorting the TV picture.

NOTE: Contact your local Infinity dealer about adding a subwoofer to your system for deep bass impact on sound effects and music.

Figure 3. Compositions Overture OVTR 1 speakers are suitable for use in a home theater system.

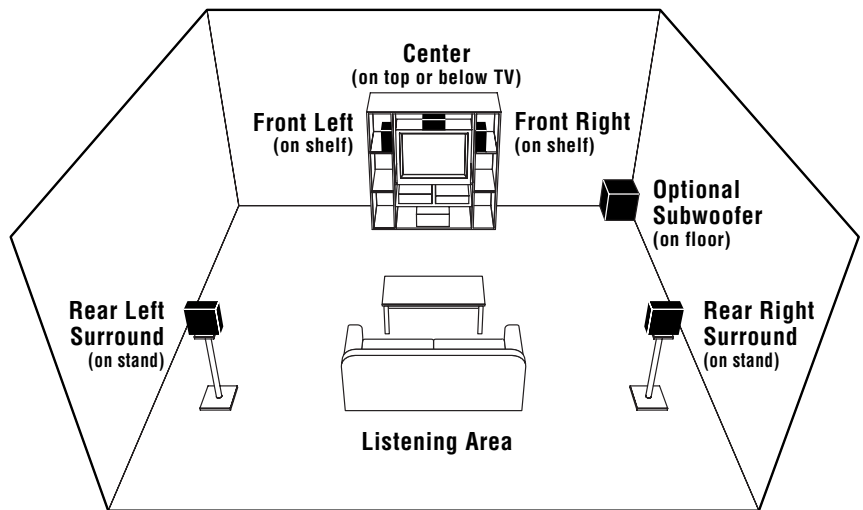

INSTALLING FEET AND GRILLES

Compositions Overture OVTR 1 speakers include two types of feet for vertical or horizontal placement on a shelf, table, or speaker stand.

VERTICAL PLACEMENT...

To insure proper woofer firing, temporarily position the speakers so that the woofer grilles face each other. On each molded foot, peel the backing from the self-adhesive tape and press each foot into its respective slot, as shown in Figure 4. Insert a grille into each speaker, so the logo is nearest the foot. Flip each speaker over and place them in your system.

Figure 4. This illustration shows how to install a molded foot for the vertical placement of a Compositions Overture OVTR 1 speaker.

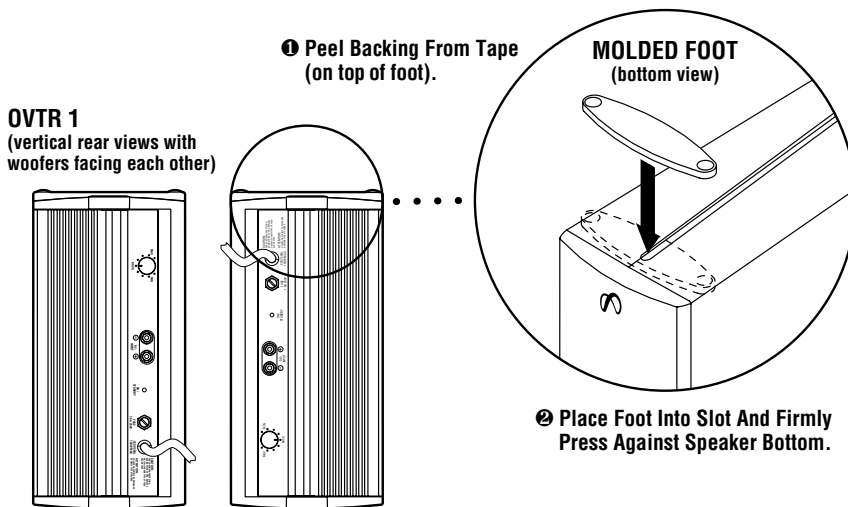

HORIZONTAL PLACEMENT...

Place two small self-adhesive feet on each speaker bottom, as shown in Figure 5. Depending on where you plan to put the speaker (e.g., TV top), place two large self-adhesive feet 4 to 6 inches away (refer to Figure 5). Insert a grille into each speaker, so the logo is nearest the foot. Flip each speaker over and place them in your system.

Figure 5. This illustration shows how to install self-adhesive feet for the horizontal placement of a Compositions Overture OVTR 1 speaker.

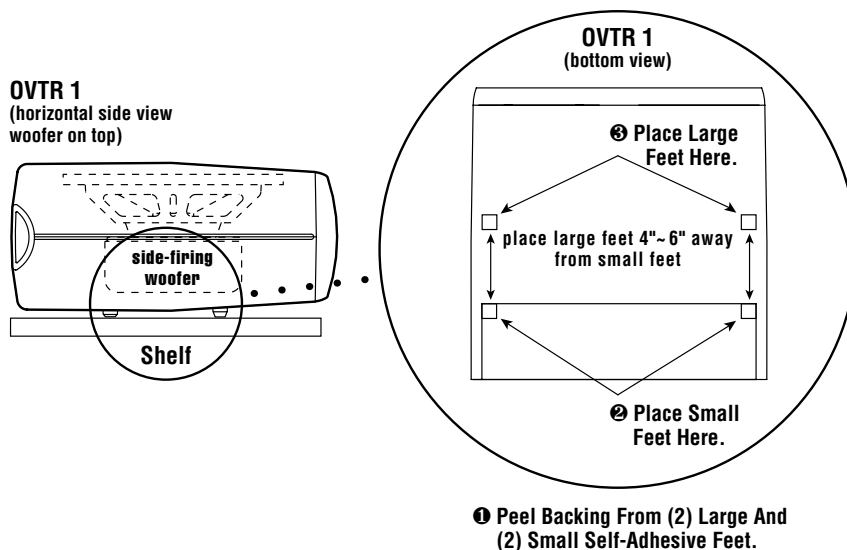

TURN OFF ALL POWER...

IMPORTANT!

IMPORTANT!

WIRING THE SYSTEM

After placing the speakers, you are ready to connect your system. First turn off all audio system power. Use high-quality speaker wire to make your connections. For speaker connections, use #18 gauge speaker wire (or #16 for runs over 25 feet) with polarity coding. The side of the wire with a ridge or other coding is usually considered negative polarity (i.e., -). Also, consult the owner's manuals that were included with your amplifier, receiver, or television to confirm connection procedures.

If your system includes a Dolby® Surround Pro Logic® or AC-3® preamplifier or A/V receiver, set the center-channel mode to NORMAL. This will route the low frequencies (below 100Hz) away from the center-channel speaker to the front left and right speakers.

Observe polarities when making speaker connections, as shown in Figures 6 and 7 below. Connect each + terminal on the back of the amplifier, receiver, or television to the respective + (red) terminal on each OVTR 1 speaker. Similarly, connect the (black) terminals in the same way.

Do not reverse polarities (i.e., + to - or - to +) when making connections. Doing so will cause poor imaging and diminished bass response.

Figure 6. Compositions Overture OVTR 1 speakers feature gold-plated terminals that can be connected in several different ways, e.g., spade terminals, and direct wiring (as shown here).

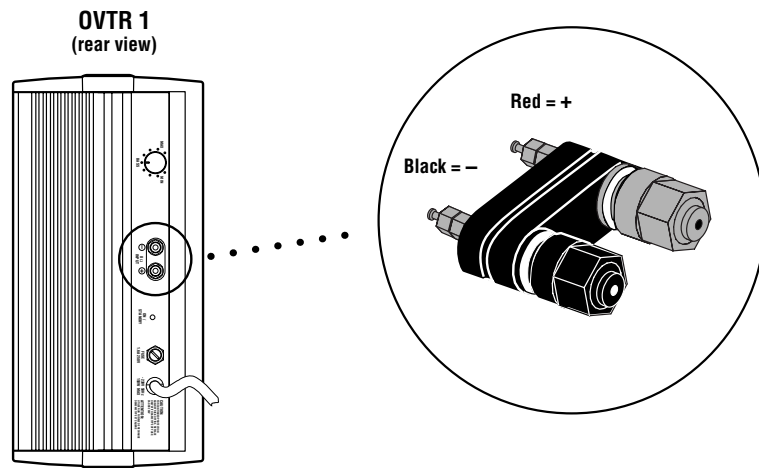

CONNECTING SPEAKERS DIRECTLY TO WIRES

Figure 7. Wiring diagram shows polarity connections for one channel of a stereo or home theater system.

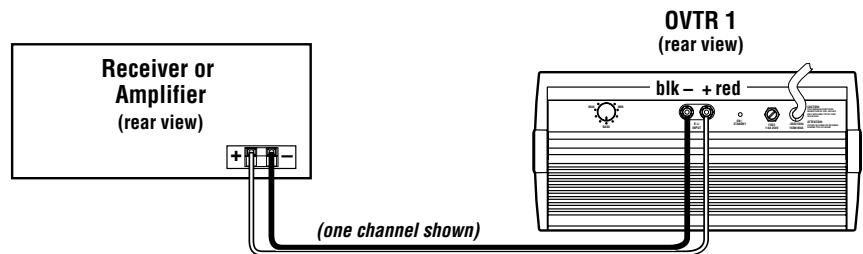

OPERATING THE SYSTEM

For your convenience, the system is fitted with a power on/off switch. Once the system is turned on, it will automatically go into a standby mode. Once an audio signal is present, the system will automatically turn on. It will revert to standby (drawing only 7 watts) when audio is absent for a minimum of 90 minutes. A dual-color “Power On” LED (see Figure 8 below) glows red when the amplifier is in the standby mode and green when the amplifier is on.

If you plan to leave for an extended period of time (e.g., vacation), switch the system off (or unplug the AC power cord).

IMPORTANT!

This product is designed for (USA) 120 Vac use only. Do not connect it to any other line voltages.

IMPORTANT!

This product is fitted with a 3-prong grounded power cord. Do not use without ensuring the outlet is grounded.

POWER ON...

1. After speaker wiring has been completed, connect each speaker's AC power cord to the nearest AC receptacle. You should see an LED illuminate, indicating the amplifier is on (see Figure 8 below). If not, verify the AC outlet is delivering power or refer to *Troubleshooting* on page 9.
2. Check the speakers for playback by first setting the audio system volume control for a minimum level, and then applying power to your system. Play a favorite music or video segment and increase the volume control to a comfortable level.

NOTE: You should hear balanced audio reproduction across the entire frequency spectrum. If not, check all wiring connections and refer to the “Troubleshooting” section on page 9 for more help.

CHECKING PLAYBACK...

Figure 8. Located on each OVTR 1's rear panel are a BASS level control and a dual-color “Power On” LED.

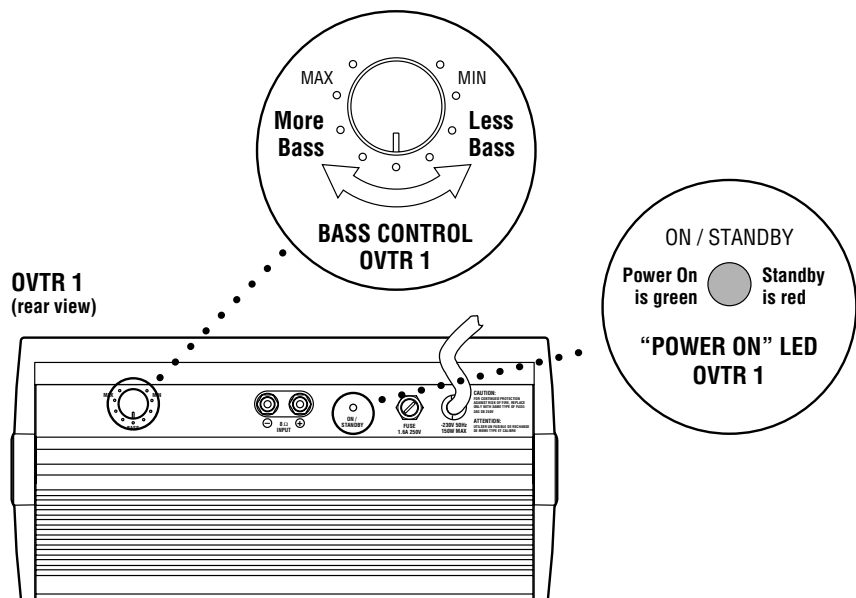

JUDGING BASS LEVEL...

OPERATING THE SYSTEM (CONT'D)

3. Listen to a variety of music selections and note the bass level. If you feel there is too much bass, you can reduce it by adjusting the BASS control from the “normal” center-detent position towards the MIN setting (see Figure 8 on previous page). Conversely, if you want more bass output, rotate the level control towards the MAX setting.

NOTE: The amount of bass you hear will be affected by a number of different factors, including the room's size and shape, the construction materials used to build the room, the listener's position relative to the speakers, and the position of the speakers in the room. If there is too much bass, move the speakers away from nearby walls. Conversely, if you want more bass, place the speakers closer to the walls (also see Figure 1 on page 3).

4. For safety reasons, the side grille is bonded in place. Please do not attempt to remove. Potential shock hazard.

REPLACING THE FUSE

Compositions Overture OVTR 1 speakers each use a built-in fuse to protect the subwoofer amplifier. To replace a fuse with a new one (see enclosed spare), perform the following procedure:

1. Switch off the speaker and unplug the power cord. Then turn the speaker around to access the fuse holder on the rear panel (refer to Figure 9 below).
2. Using a small flat-blade screwdriver, place the tip in the indent and turn the fuse cap counterclockwise.
3. Remove the old fuse and replace it with a new one having the same value and rating, a 2AG 3A SB 250V fuse.
4. Insert the cap holding the new fuse into the holder and turn clockwise to lock it.
5. Rotate the speaker to its original position. Then plug the speaker's AC power cord back into the nearest AC outlet.

IMPORTANT!

Do not substitute the blown fuse with another fuse value or rating. Doing so will void the warranty.

Figure 9. The OVTR 1's fuse is located on the rear panel next to the AC power cord.

OVTR 1
(rear view)

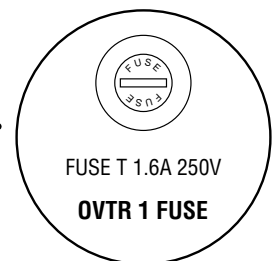
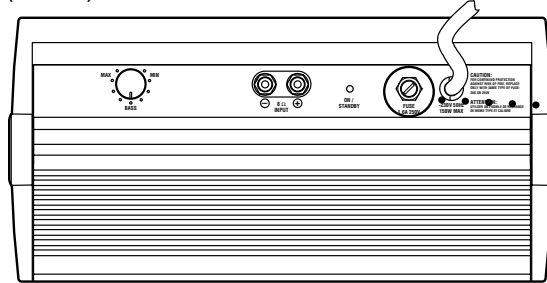

CARE OF YOUR SPEAKER SYSTEM

The dark grey metallic finish does not require any routine maintenance. When needed, use a soft cloth, dampened with water only, to remove any fingerprints or to wipe off dust. Clean the grille by gentle vacuuming or with a damp cloth.

NOTE: Do not use any cleaning products or polishes on the cabinet or grille.

For maximum acoustic transparency, the grille uses a lightweight structure that needs to be handled with care for removal. To remove the grille, gently pull on the corners to unfasten the frame from the cabinet. To replace it, make sure to align the frame pins first and then gently snap the frame into place. Never force the grille frame onto the cabinet.

TROUBLESHOOTING*

SYMPTOM	CAUSE	SOLUTION
Bass is too loud	Bass reinforcement in room	Move speakers away from walls
	Bass level is too high	Rotate BASS control toward "1" (see page 8)
Bass sounds distorted	Subwoofer amplifier has reached maximum output	Turn down volume control on receiver or preamplifier
	Bass level on preamp/receiver is set too high	Set bass and treble flat; use controls sparingly
Distortion with volume control near minimum	Defective receiver or preamplifier; shorted speaker wires	Repair defective receiver or preamplifier
Distortion on music or effects peaks (e.g., pops or noise)	Dynamic sound track causes subwoofer to "bottom" out	Turn down master volume control to lower overall range
	Tone controls are set too high	Set bass and treble flat; use controls sparingly
Buzz, hum, or crackle when connecting wires	Connecting wires with power on causes transient signal spikes	Connect wires only when audio system power is off
No sound from system; power LED not on	Power cord not connected; no AC power	Connect AC power cord; speaker check AC outlet
	Blown fuse	Check or replace fuse (see page 8)

**If you need further assistance, contact your local Infinity retail dealer.*

PERFORMANCE DATA

DRIVE UNITS

AMPLIFIER

(BUILT-IN POWER AMPLIFIER FOR
LOW-FREQUENCY SECTION)

DIMENSIONS

(also see inside front cover)

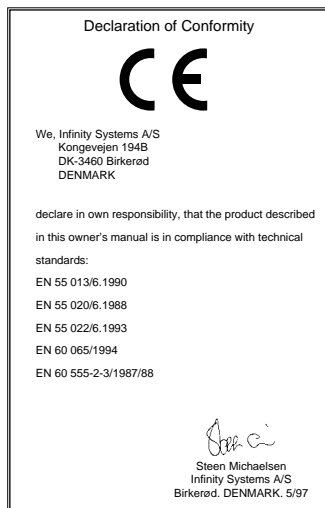

SPECIFICATIONS – OVTR 1

Frequency Range:	35 ~ 20,000Hz
Sensitivity:	92dB spl @ 1 m/2.83 V (anechoic conditions)
Impedance:	8 Ω nominal
Maximum Peak Output:	108dB (spl on program)
Amplifier Requirements:	Recommended for use with amplifiers 10 ~ 100 W (@ 8 Ω)
Low Frequency:	One 8" (200 mm) high-efficiency, ultra-linear, long-throw, magnetically- shielded woofer
Mid Frequency:	Two 4" (100 mm) high-efficiency, magnetically-shielded, mid-range drivers
High Frequency:	One 1" (25 mm) soft-dome, high-efficiency, neodymium magnet, magnetically- shielded tweeter
Crossover Frequencies:	300 and 3,000Hz
Peak Output:	250 VA
Power Supply:	120 V~ 60Hz
Power Consumption:	150 W (maximum), 7 W (standby)
Width:	5 $\frac{3}{4}$ " (146 mm)
Height:	12 $\frac{1}{2}$ " (318 mm)
Depth:	12 $\frac{1}{2}$ " (318 mm)
Weight:	28.5 lb or 12.95 kg (each)

LIMITED FIVE-YEAR WARRANTY

Who is protected by the warranty?

Your Infinity warranty protects the original retail purchaser and all subsequent owners for a period of five (5) years (parts and labor) for all speaker components, and one (1) year (parts and labor) for all electronics, from any failure as a result of an original manufacturing defect so long as:

(1) your Infinity loudspeakers were purchased within the fifty states of the U.S.A. or by military personnel from an authorized military outlet and (2) the original dated bill of sale is presented whenever service is required during the warranty period. This warranty does not apply to products purchased elsewhere; other purchasers should contact their local Infinity distributor for warranty information.

What does the Infinity warranty cover?

Except as specified below, this warranty covers all defects in original materials and workmanship. The following are not covered: damage caused by accident, misuse, abuse, neglect, product modification; damage occurring during shipment, damage caused by failure to follow instructions in the owner's manual, including failure to perform recommended periodic or routine maintenance; damage resulting from repairs by someone not authorized by Infinity; claims based upon any misrepresentations by the sellers; and any Infinity product on which the serial number has been altered, defaced or removed.

Who pays for what?

During the period of this warranty, subject to the above conditions, Infinity will pay all of the labor and material expenses to repair a warrantable defect.

How can warranty service be obtained?

In the event that your Infinity loudspeaker should require service, you should first contact the Infinity dealer from whom the product was purchased or, if this is not practical, contact Infinity directly (ATTN: Customer Service) at 20630 Nordhoff Street, Chatsworth, CA 91311 (818) 407-0228. We may direct you to an authorized service center for Infinity products or ask you to send them to us for repair. In either case, you will have to present your original bill of sale to establish warranty coverage.

Do not send your speaker to us without prior authorization from our Customer Service Department. You are responsible for transporting your product to either Infinity or an authorized service center and for payment of all shipping charges; however, Infinity will pay the return shipping charges (in the event you return the product to us) if the repairs are covered by warranty. If you experience difficulty in transporting your product or are in need of packing materials, please advise us and we may be able to suggest alternative procedures and/or provide adequate packing materials.

LIMITATION OF IMPLIED WARRANTIES: All implied warranties, including fitness for a particular purpose and merchantability are limited in duration to the length of the warranty period for your product.

LIMITATION OF INCIDENTAL OR CONSEQUENTIAL DAMAGES: Infinity is not responsible for an incidental or consequential damage of any kind. Our liability is limited to the repair or replacement, at our option, of a defective product.

Some states do not allow limitations on how long an implied warranty lasts and/or do not allow the exclusion of incidental or consequential damages, so the above limitations or exclusions may not apply to you. This warranty gives you specific legal rights and you may also have other rights which vary from state to state.

NOTE: *In the event that there is a difference between this warranty and the provisions in any advertisements, product brochure or packaging cartons, the terms of this warranty will prevail.*

Infinity constantly strives to update and improve existing products, as well as create new ones. Therefore the specifications and construction details in this and related Infinity publications are subject to change without notice.

© 1997 Infinity Systems Inc., 80 Crossways Park West, Woodbury, NY 11797 USA
(516) 496-3400 • FAX (516) 496-4868

Infinity is a registered trademark of Infinity Systems, Inc. Compositions is a trademark of Infinity Systems, Inc. Dolby, Pro Logic, and AC-3 are trademarks of Dolby Laboratories Licensing Corp.