

Compact Disc Recorder

Operating Instructions

Owner's Record

The model and serial numbers are located on the rear of the unit. Record the serial number in the space provided below. Refer to them whenever you call upon your Sony dealer regarding this product.

Model No. _____ Serial No. _____



RCD-W500C/W100

WARNING

To reduce the risk of fire or electric shock, do not expose this apparatus to rain or moisture.

To prevent fire, do not cover the ventilation of the apparatus with newspapers, table-cloths, curtains, etc. And don't place lighted candles on the apparatus.

To prevent fire or shock hazard, do not place objects filled with liquids, such as vases, on the apparatus.

This appliance is classified as a CLASS 1 LASER product. This marking is located on the rear exterior.

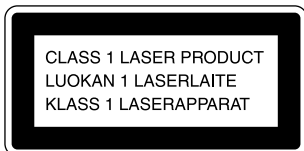

CAUTION – CLASS 1M INVISIBLE LASER RADIATION WHEN OPEN AND INTERLOCK DEFEATED. DO NOT VIEW DIRECTLY WITH OPTICAL INSTRUMENTS.

The following caution label is located inside the apparatus.



Don't throw away the battery with general house waste, dispose of it correctly as chemical waste.

NOTICE FOR THE CUSTOMERS IN THE UNITED KINGDOM

A moulded plug complying with BS1363 is fitted to this equipment for your safety and convenience.

Should the fuse in the plug supplied need to be replaced, a fuse of the same rating as the supplied one and approved by ASTA or BSI to BS1362, (i.e., marked with ⚡ or ⚡ mark) must be used.

If the plug supplied with this equipment has a detachable fuse cover, be sure to attach the fuse cover after you change the fuse. Never use the plug without the fuse cover. If you should lose the fuse cover, please contact your nearest Sony service station.

For the customers in the U.S.A.

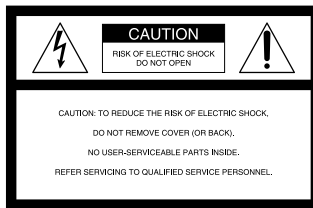

This symbol is intended to alert the user to the presence of uninsulated "dangerous voltage" within the product's enclosure that may be of sufficient magnitude to constitute a risk of electric shock to persons.



This symbol is intended to alert the user to the presence of important operating and maintenance (servicing) instructions in the literature accompanying the appliance.

CAUTION

You are cautioned that any changes or modifications not expressly approved in this manual could void your authority to operate this equipment.

WARNING

This equipment has been tested and found to comply with the limits for a Class B digital device, pursuant to Part 15 of the FCC Rules. These limits are designed to provide reasonable protection against harmful interference in a residential installation. This equipment generates, uses, and can radiate radio frequency energy and, if not installed and used in accordance with the instructions, may cause harmful interference to radio communications. However, there is no guarantee that interference will not occur in a particular installation. If this equipment does cause harmful interference to radio or television reception, which can be determined by turning the equipment off and on, the user is encouraged to try to correct the interference by one or more of the following measures:

- Reorient or relocate the receiving antenna.
- Increase the separation between the equipment and receiver.
- Connect the equipment into an outlet on a circuit different from that to which the receiver is connected.
- Consult the dealer or an experienced radio/TV technician for help.

As the laser beam used in this unit is harmful to eyes, do not attempt to disassemble the cabinet. Refer servicing to qualified personnel only.

For the customers in Canada

This Class B digital apparatus complies with Canadian ICES-003.

CAUTION

TO PREVENT ELECTRIC SHOCK, DO NOT USE THIS POLARIZED AC PLUG WITH AN EXTENSION CORD, RECEPTACLE OR OTHER OUTLET UNLESS THE BLADES CAN BE FULLY INSERTED TO PREVENT BLADE EXPOSURE.

Table of Contents

Getting Started

Unpacking	6
Hooking Up the System	6
This Unit Can Use the Following Discs	7

Basic Operations

Playing a CD	8
Playing a disc with MP3 files	9
Using the Display	13
Locating a Specific Track	15
Locating a Particular Point in a Track	16
Playing Tracks/Discs Repeatedly (Repeat Play)	17
Playing in Random Order (Shuffle Play)	18
Creating Your Own Program (Program Play)	19

Recording/Editing

Before Recording	20
Synchro-Recording a CD to CD-R or CD-RW	22
Recording on a CD-R or CD-RW Manually	25
Adjusting the Recording Level	27
Marking Track Numbers While Recording	28
Fading In and Out recording (Rec Fader)	29
Finalizing a CD-R or CD-RW	29
Unfinalizing a CD-RW	30
Erasing Tracks of a CD-RW	31
Labeling Tracks/Discs	32
Useful Tips for Recording	33

Additional Information

Using the Setup Menu	35
Messages	36
Self-diagnosis Function	37
System Limitations	38
Troubleshooting	38
Specifications	Back cover

Welcome

Thank you for purchasing this Sony Compact Disc Recorder. Before operating the unit, please read this manual thoroughly and retain it for future reference.

About This Manual

The instructions in this manual are for 2 models: RCD-W500C and RCD-W100.

RCD-W500C is the model used for illustration purposes.

Conventions

- Instructions in this manual describe the controls on the unit. You can also use the controls on the remote if they have the same or similar names as those on the unit.
- The following icon is used in this manual:



Indicates that you can do the task using the remote.

Precautions

On safety

- Should any solid object or liquid fall into the cabinet, unplug the unit and have it checked by qualified personnel before operating it any further.
- The use of optical instruments with this product will increase eye hazard.

On power sources

- Before operating the unit, check that the operating voltage of the unit is identical with your local power supply. The operating voltage is indicated on the nameplate at the rear of the unit.
- The unit is not disconnected from the AC power source (mains) as long as it is connected to the wall outlet, even if the unit itself has been turned off.
- If you are not going to use the unit for a long time, be sure to disconnect the unit from the wall outlet. To disconnect the AC power cord, grasp the plug itself; never pull the cord.
- AC power cord must be changed only at the qualified service shop.

On condensation in the unit

If the unit is brought directly from a cold to a warm location, or is placed in a very damp room, moisture may condense on the lenses inside the unit. Should this occur, the unit may not operate properly. In this case, remove the CD, CD-R, or CD-RW and leave the unit turned on for about an hour until the moisture evaporates.

On handling discs

- To keep the disc clean, handle it by its edge. Do not touch the surface.
- Do not stick adhesive papers or tapes onto the disc.



- If there is glue or a similar substance on the disc, remove it completely before using the disc.

On storage

- Do not expose the disc to direct sunlight or heat sources such as hot air ducts, nor leave it in a car parked in direct sunlight as there can be a considerable rise in temperature inside the car.
- Store discs in their cases. Do not store discs either stacked horizontally or standing vertically without their cases.

On cleaning

- Fingerprints or dust on the disc may cause poor sound reproduction or sound dropout.
- Before playing a disc, clean it with a cleaning cloth. Wipe the disc from the center out.



- If the disc is still dirty after being wiped with a cleaning cloth, wipe it again with a slightly moistened cloth. Then wipe off the residual moisture with a dry cloth.
- Do not use solvents such as benzene, thinner, commercially available cleaners, or antistatic spray intended for vinyl LPs.

Note on discs

With the following kinds of discs, you may experience a reading failure or noise when recorded to a CD-R or CD-RW.

- Discs with adhesive labels attached to them
- Irregularly shaped discs (for example, heart or star shaped)
- Discs with heavy printing on only one section (may effect the balance of the disc in the disc tray)
- Old discs
- Scratched discs
- Dirty discs
- Warped discs

Note on High-Speed Synchro-Recording

When recording a CD, certain conditions may cause the sound to dropout, noise in the recording, or even unwanted tracks on the CD-R or CD-RW. If this happens, clean the CD as described in “On cleaning” above, and record to the CD-R or CD-RW using normal speed Synchro-Recording only.

Note on CD-R or CD-RW playback

Playback of a CD-R or CD-RW recorded by a CD-R or CD-RW recorder may not be possible depending on the recording conditions (e.g., dirty disc, etc.). Also, please note that you need to finalize a CD-R or CD-RW before playing it back on DECK A of this unit or a system other than the one used to make the recording. (Finalizing is a process to complete the recording.) After finalizing a CD-R, you can play it in any conventional CD player. However, depending on the state of the recording, the sound may skip during playback. After finalizing a CD-RW, you can play it in a CD-RW compatible player only.

Music discs encoded with copyright protection technologies

This product is designed to playback discs that conform to the Compact Disc (CD) standard. Recently, various music discs encoded with copyright protection technologies are marketed by some record companies. Please be aware that among those discs, there are some that do not conform to the CD standard and may not be playable by this product.

Unpacking

Check that the following items are included:

- Audio connecting cords
- Phono plug × 2 (red/white) ↔ Phono plug × 2 (red/white) (2)
- Remote commander (remote) (1)
- R6 (size AA) batteries (2)

Inserting batteries into the remote

You can control the unit using the supplied remote.

Insert two R6 (size AA) batteries by matching the ⊕ and ⊖ ends on the batteries to the markings inside the compartment. When using the remote, point it at the remote sensor  on the unit.

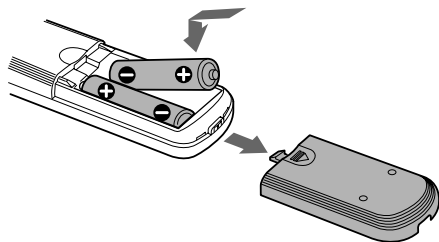

Tip

With normal use, the batteries should last for about six months. When the remote no longer operates the unit, replace both batteries with new ones.

Notes

- Do not leave the remote near an extremely hot or humid place.
- Do not drop any foreign object into the remote casing, particularly when replacing the batteries.
- Do not expose the remote sensor to direct light from the sun or lighting apparatus. Doing so may cause a malfunction.
- If you don't use the remote for an extended period of time, remove the batteries to avoid possible damage from battery leakage and corrosion.

Hooking Up the System

This section describes how to hook up the unit to an amplifier. Be sure to turn off the power of each component before making the connections.

Connecting the unit to an amplifier

Connect the amplifier to the ANALOG IN/OUT jacks using the audio connecting cords (supplied), making sure to match the color-coded pins to the appropriate jacks on the components: red (R) to red and white (L) to white. Be sure to make connections firmly to prevent hum and noise.

Audio connecting cords (supplied) (2)

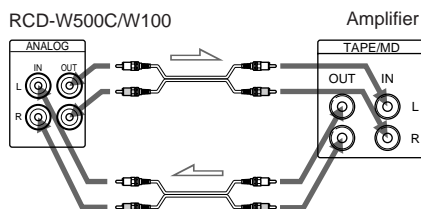
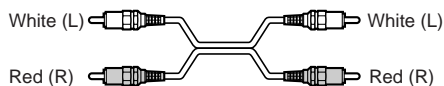

 : Signal flow

Connecting the unit to a digital component

Connect a component such as digital amplifier, CD player, DAT deck, or MD deck through the DIGITAL OPTICAL IN/OUT jacks (S/PDIF square type) with a optical digital cord (not supplied). Be sure to insert the plug until it clicks into place.

Optical digital cord (not supplied)



Connecting the AC power cord

Connect the AC power cord to a wall outlet.

Notes

- Install this system so that the power cord can be unplugged from the wall socket immediately in the event of trouble.
- Be sure to place the player on a flat, horizontal place. If the player is left on a slanted position, it may cause a malfunction or damage the player.

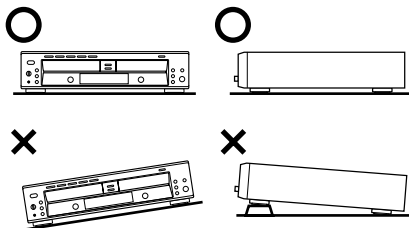

- If the following occurs during CD playback or recording, a reading error may occur or noise may be produced in the recorded results:
 - The disc tray or other part of the system is bumped.
 - The system is placed on an uneven or soft surface.
 - The system is located near a speaker, door, or other source of vibration.

This Unit Can Use the Following Discs

The unit can use three types of discs as follows:

Audio CDs



Discs with these logos can be played by both DECK A (the CD player section) and DECK B (the CD-R or CD-RW recording section) of the unit.



Audio CD-R



Discs with this logo are **recordable only one time**. When you finalize the disc (page 29), you can play it in either DECK A (the CD player section) or DECK B (the CD-R or CD-RW

recording section), or any conventional CD player (you may not be able to play it in some CD players), including home, car, and portable models. (An unfinalized disc can be played only in DECK B.) When you buy a CD-R, please note that you must buy an audio CD-R. A CD-R designed for computer use will not work in this unit.

Audio CD-RW



Discs with this logo are **recordable, and also re-writable**. When you finalize the disc (page 29), you can play it in either DECK A (the CD player section) or DECK B (the CD-R or CD-

RW recording section), and CD-RW compatible players. They will not play back in most current CD players unless the player is CD-RW compatible. (An unfinalized disc can be played only in DECK B.) When you buy a CD-RW, please note that you must buy an audio CD-RW. A CD-RW designed for computer use will not work in this unit.



This logo means that an unit is compatible with Audio CD-R and Audio CD-RW (both Audio CD-R and Audio CD-RW can be used).

Note

On this player, you can play MP3 files on DECK A only. For details, see “Playing a disc with MP3 files” on page 11.

Playing a CD

This unit has two decks.

In this manual, the CD player section is just called DECK A, and the CD-R and CD-RW recording section is called DECK B.

When using the remote, set DECK A/DECK B to DECK A to operate DECK A (the CD player section), or to DECK B to operate DECK B (the CD-R or CD-RW recording section).

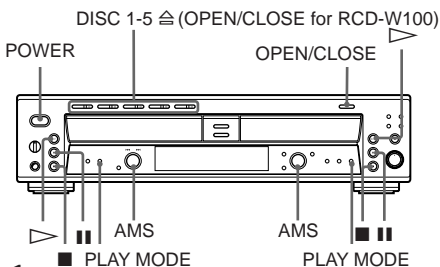

- 1 Turn on your amplifier and adjust the volume to the minimum.
- 2 Set your amplifier's input selector to select this unit.
- 3 Press POWER.
- 4 Press OPEN/CLOSE (or one of the DISC 1-5 buttons) and place a disc on the inner circle of DECK A (or B). Press OPEN/CLOSE (or the button) again to close the disc tray.



With the label side up

- 5 For DECK A of RCD-W500C, press PLAY MODE repeatedly to select the Continuous play mode.

When you select	The unit plays
ALL DISCS	All discs in the unit consecutively in the order of the disc number.
1 DISC/ ALBUM	Only one disc you have selected.

6 Press ▷.

The unit starts playing. Adjust the volume on the amplifier.

To	Do the following:
Stop playback	Press ■.
Pause playing	Press ■. Press the button again or press ▷ to resume playing.
Select the disc (for DECK A of RCD-W500C)	Press one of the DISC 1-5 buttons.
Go to the next disc (for DECK A of RCD-W500C)	Press DISC SKIP on the remote.
Go to the next track	Turn AMS* clockwise while the ALBUM SELECT indicator in the display is turned off (or press ► on the remote).
Go to the beginning of the current track or the preceding track	Turn AMS counterclockwise while the ALBUM SELECT indicator in the display is turned off (or press ◀ on the remote).
Remove the disc	Press OPEN/CLOSE (or the button), whichever contains the disc you want to remove after stopping play.

*AMS: Automatic Music Sensor

Tips

- You can start playing from a specific track in step 6.
 - 1 Turn AMS while the ALBUM SELECT indicator in the display is turned off (or press ◀/▶ or the number buttons on the remote) to select the track you want to play (see "Using the Display" on page 13 for details about the displayed information).
 - 2 Press ▷.
- You can remove or load discs while playing the other deck. Press OPEN/CLOSE (or the button) of the deck that is not currently playing to open that tray, and remove or load a disc.
- The DISC 1-5 button indicator lights orange when the disc is in the tray. The indicator lights to green when the disc is selected (RCD-W500C only).
- You can connect headphones to the PHONES jack on the front panel. Turn the PHONE LEVEL control to adjust the volume.
- You can replace any discs in the other disc trays while playing a disc in DECK A of RCD-W500C. Press the button of the deck that is not currently playing to open that tray, and remove or load a disc (Exchange function).

Notes

- You cannot play both decks simultaneously. If you start playing a disc while playing a disc on another deck, the playback of former deck stops.
- You can play unfinalized CD-Rs or CD-RWs only in DECK B. For the detailed explanation about finalizing, see “Finalizing a CD-R or CD-RW” on page 29.
- Be sure to close the disc trays when the unit is not in use to prevent dust and dirt from entering and prevent damage to the disc tray.
- When you turn on the unit, you will hear some mechanical noise from the unit. This is not a malfunction.
- The play mode setting is canceled when you turn the unit off.

Playing a disc with MP3 files

About MP3 files

MP3 (MPEG 1 Audio Layer-3) is a standard technology and format for compressing a sound sequence. The file is compressed to about 1/10 of its original size. Sounds outside the range of human hearing are compressed while the sounds we can hear are not compressed.

Playback of some MP3 files may not be possible, depending on the encoding.

The encoding method (i.e., the bit rate selected for encoding) will affect the sound quality of the MP3 files created. The bit rate typically used for MP3 files is 128 kbps.

About ID3 tag

ID3 tag is the text information (track title, album title, artist name, etc.) stored in the MP3 files.

Notes on discs

You can play MP3 files recorded on CD-ROMs, CD-Rs (recordable CDs), and CD-RWs (rewritable CDs). The disc must be in the ISO 9660*¹ level 1 or level 2 format, or Joliet or Romeo in the expansion format. You can use a disc recorded in Multi Session*².

*¹ISO 9660 Format

The most common international standard for the logical format of files and folders on a CD-ROM.

There are several specification levels. In Level 1, file names must be in the 8.3 format (no more than eight characters in the name, no more than three characters in the extension “.MP3”) and in capital letters. Folder names can be no longer than eight characters. There can be no more than eight nested folder levels. Level 2 specifications allow file names up to 31 characters long. Each folder can have up to 8 trees. For Joliet or Romeo in the expansion format, make sure of the contents of the writing software, etc.

*²Multi Session

This is a recording method that enables adding of data using the Track-At-Once method. Conventional CDs begin at a CD control area called the Lead-in and end at an area called Lead-out. A Multi Session CD has multiple sessions, with each Lead-in to Lead-out segment regarded as a single session. CD-EXTRA: A format in which CD-DA (audio) data are recorded in the tracks of session 1 and computer data in the tracks of session 2. Mixed CD: A format in which computer data are recorded in the first track and CD-DA (audio) data in the following tracks within a session.

Notes

- With formats other than ISO 9660 level 1, folder names or file names may not be displayed correctly.
- When naming, be sure to add the file extension “.MP3” to the file name.
- If you add the extension “.MP3” to a file other than MP3, the unit cannot recognize the file properly and will generate random noise that could damage your speakers.
- The following discs take a longer time to start playback.
 - a disc recorded with a complicated tree structure.
 - a disc recorded in Multi Session.
 - a disc to which data can be added (non-finalized disc).

Cautions when playing a disc that is recorded in Multi Session

CD-DA (audio) data or MP3 files stored on a Multi Session CD may be subject to some restrictions on playback.

- If the disc begins with a CD-DA session, it is recognized as a CD-DA (audio) disc, and playback continues until an MP3 session is encountered.
- If the disc begins with an MP3 session, it is recognized as an MP3 disc, and playback continues until a CD-DA (audio) session is encountered.
- The playback range of an MP3 disc is determined by the tree structure of files produced by analyzing of the disc.
- A disc with a mixed CD format will be recognized as a CD-DA (audio) disc.

The playback order of the MP3 files
The playback order of the folders and files is as follows:

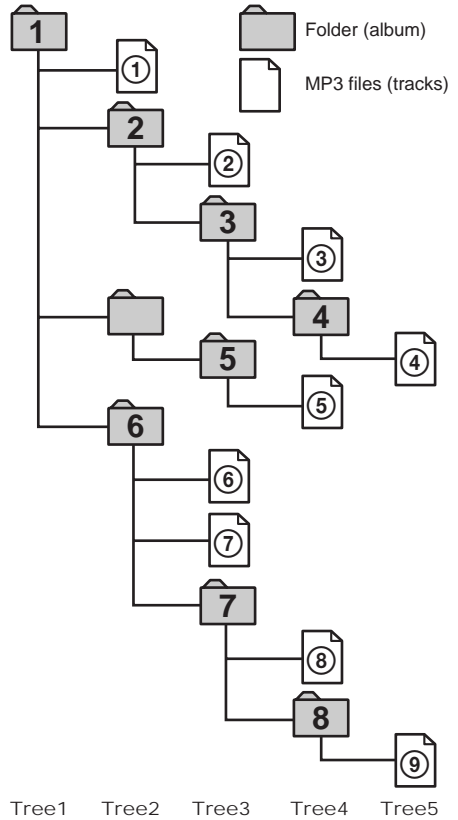

Notes

- This player cannot read the MP3 files if the file name does not end with the extension “.mp3”.
- Folders that do not include MP3 files are skipped.
- When you insert a disc with many trees, it takes a longer time to start playback. We recommend that you make only one or two trees for each disc.
- Maximum total number of MP3 files and folders is 300, and maximum number of folders is 150 (including root folder and empty folders).
- If the maximum number of folders or MP3 files is exceeded, the additional folders/MP3 files are not recognized. For example, if you insert the disc with 151 folders, the player reads only 150 folders.
- The CD player can play MP3 files in folders nested up to 8 layers deep in the folder tree.

Tip

To specify a desired playback order, before the folder or file name, input the order by number (e.g., "01", "02"), then record contents onto a disc. (The order differs depending on the writing software.)

Note on playback of MP3 files

Depending on the encoding/writing software, recording device, or the recording media used at the time an MP3 file is recorded, you may encounter such problems as disabled playback, sound interruptions, and noise.

Playing a disc with MP3 files (DECK A only)

This system lets you play discs with MP3 files.

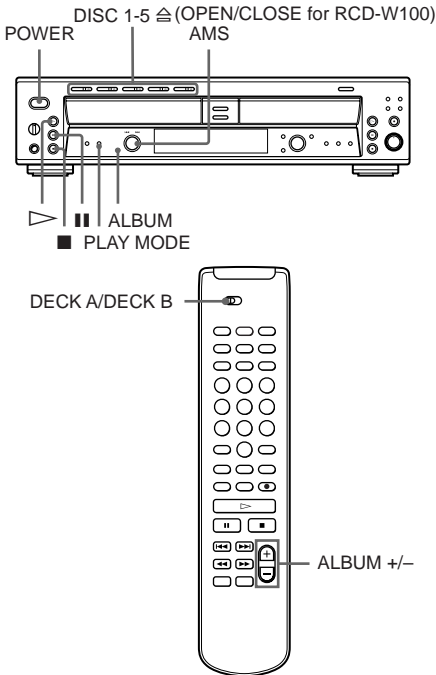

- 1 Turn on your amplifier and adjust the volume to the minimum.
- 2 Set your amplifier's input selector to select this unit.
- 3 Press POWER.
- 4 Press OPEN/CLOSE (or one of the DISC 1-5 \triangle buttons for RCD-W500C) and place a disc. Press OPEN/CLOSE (or \triangle) again to close the disc tray.



With the label side up



- 5 Press PLAY MODE repeatedly to select the Continuous play mode.

When you select	The unit plays
ALL DISCS	All discs in the unit consecutively in the order of the disc number.
1 DISC	Only one disc you have selected.
ALBUM*	All MP3 files in the selected album on the selected disc.

* When a disc that contains no album is played with "ALBUM" selected, the disc is played in the same way as 1 DISC mode.



- 6 To select an album, press ALBUM until the ALBUM SELECT indicator in the display lights up, then turn AMS until the album you want appears (or press ALBUM +/- on the remote).
- 7 Press \triangle .
The unit starts playing. Adjust the volume on the amplifier.

continued

To	Do the following:
Stop playback	Press ■.
Pause playing	Press ■. Press the button again or press ▷ to resume playing.
Select the disc (for DECK A of RCD-W500C)	Press one of the DISC 1-5 buttons.
Go to the next disc (for DECK A of RCD-W500C) 	Press DISC SKIP on the remote.
Go to the next track	Turn AMS* clockwise while the ALBUM SELECT indicator in the display is turned off (or press ►► on the remote).
Go to the beginning of the current track or the preceding track	Turn AMS counterclockwise while the ALBUM SELECT indicator in the display is turned off (or press ◀◀ on the remote).
Go to the next album	Turn AMS clockwise while the ALBUM SELECT indicator in the display is turned on (or press ALBUM + on the remote).
Go back to the preceding album	Turn AMS counterclockwise while the ALBUM SELECT indicator in the display is turned on (or press ALBUM – on the remote).
Remove the disc	Press OPEN/CLOSE (or ) , whichever contains the disc you want to remove after stopping play.

* AMS: Automatic Music Sensor

Tips

- The function of AMS control changes according to the ALBUM SELECT indicator in the display. When the indicator is off, the AMS control selects tracks. When the indicator lights up, the AMS control selects albums. Press ALBUM to turn the ALBUM SELECT indicator on or off.
- You can start playing from a specific track in step 7.
 - 1 Turn AMS while the ALBUM SELECT indicator in the display is turned off (or press ◀◀/►► or the number buttons on the remote) to select the track you want to play (see “Using the Display” on page 13 for details about the displayed information).
 - 2 Press ▷.
- You can remove or load discs while playing the other deck. Press OPEN/CLOSE (or ) of the deck that is not currently playing to open that tray, and remove or load a disc.
- The DISC 1-5 button indicator lights orange when the disc is in the tray. The indicator lights green when the disc is selected (RCD-W500C only).
- You can connect a headphone to the PHONES jack on the front panel. Turn the PHONE LEVEL control to adjust the volume.
- You can replace any discs in the other disc trays while playing a disc in DECK A of RCD-W500C. Press  of the deck that is not currently playing to open that tray, and remove or load a disc (Exchange function).

Notes

- You can play unfinalized CD-Rs or CD-RWs only in DECK B. For the detailed explanation about finalizing, see “Finalizing a CD-R or CD-RW” on page 29.
- Be sure to close the disc trays when the unit is not in use to prevent dust and dirt from entering and prevent damage to the disc tray.
- When you turn on the unit, you will hear some mechanical noise from the unit. This is not a malfunction.
- You may not be able to play certain MP3 files.
- “0:00” appears when skipping a portion of ID3 ver.2 tag. The skipping time depends on the size of the ID3 ver.2 tag.

Using the Display

You can check information about the disc using the front panel display.

When using the remote, set DECK A/DECK B to DECK A to operate DECK A, or to DECK B to operate DECK B.

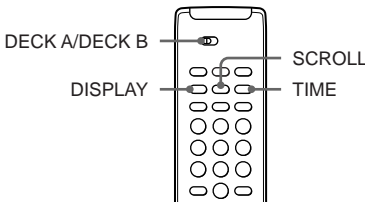
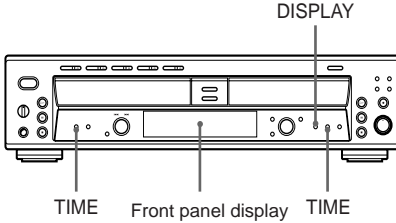

Changing the display

Press DISPLAY while the unit is stopped or playing. Each time you press the button, you can change the display as follows:

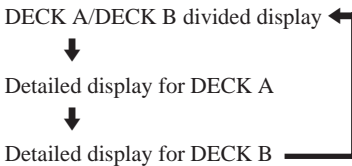

DECK A/DECK B divided display

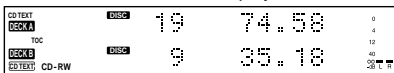

Detailed display for DECK A

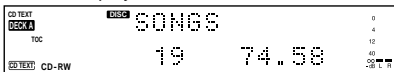

Detailed display for DECK B



Tips

- When either of the detailed displays are selected, the disc, track, and album titles are displayed as follows:
 - The disc or album title appears whenever the unit is stopped.
 - The title of the current track appears when a track is playing.

To label a disc and its tracks, see “Labeling Tracks/ Discs” on page 32.

- You can scroll disc or track titles that do not fit entirely into the display. Press SCROLL on the remote to see the rest of the title. Press SCROLL again to pause scrolling, and again to continue scrolling.
- When you put a CD containing a CD text in the disc tray, “CD TEXT” lights up in the display.

Note

For MP3 files, some characters cannot be displayed. These characters are displayed as a space or the system’s original character.

Display while the unit is stopped

The information appears as follows:

DECK A

When you place a CD/CD-R/CD-RW:
The total track number and total playing time

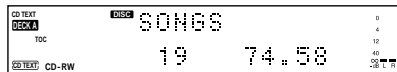

When you place a disc with MP3 files:
The total number of MP3 files in the album



Tip

The disc title and total number of albums are displayed just after the unit reads TOC information of MP3 files.

Notes

- The total playing time is not displayed for MP3 files.
- The ID3 tag is not displayed for MP3 files.
- Maximum total number of MP3 files and folders is 300, and maximum number of folders is 150 (including root folders and empty folders). If the maximum number of folders or MP3 files is not exceeded, the additional folders/MP3 files are not recognized.

continued

DECK B

When you placed an unfinalized CD-R or CD-RW in DECK B, you can also check the remaining recordable time by pressing TIME. The information appears as follows:

The total track number and total playing time

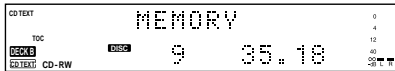

The remaining recordable time of the disc (only the unfinalized CD-R or CD-RW)

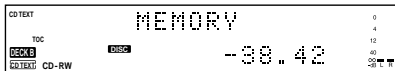

Display while playing

Press TIME repeatedly while the unit is playing. Each time you press the button, the display for any deck that has a disc inside changes as follows:

DECK A

The track number and playing time

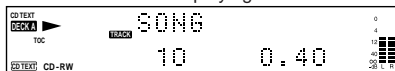

The track number and remaining time of the track currently being played

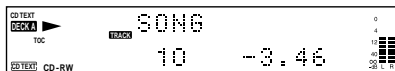

The total remaining time of the disc (in Continuous play mode)

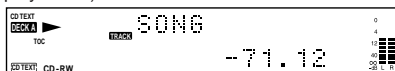

Tips

- When displaying track titles for MP3 files, this player gives preference to file information in the following order: ID3 ver.1 tag, ID3 ver.2 tag, MP3 file name. However, the information is not displayed in this way depending on the disc.
- When the ID3 tag is displayed for MP3 files, "ID3" lights up. The ID3 tag is consisted of the track title, album title, and artist name.

Notes

- The remaining time does not appear for MP3 files.
- The level meter does not appear when playing MP3 files.

DECK B

The track number and playing time



The track number and remaining time of the track currently being played

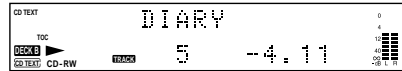

The total remaining time of the disc (in Continuous play mode)

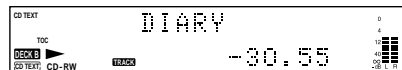

Display while recording

Press TIME repeatedly while recording. Each time you press the button, the display for DECK B changes as follows:

The track number and recording time of the track currently being recorded

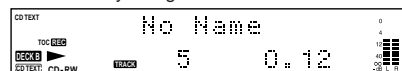

The total remaining time of the CD-R or CD-RW

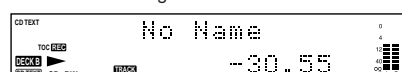

Display for disc information of DECK B

The indicators show which type of recordable disc is in the disc tray, and whether the recordable disc has been already finalized.

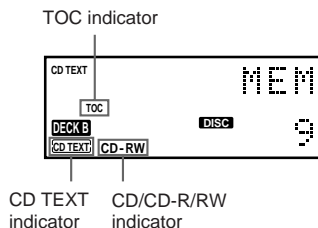

The CD/CD-R/RW indicator

When you put a CD or finalized CD-R in the disc tray, "CD" lights up.

When you put an unfinalized CD-R in the disc tray, "CD-R" lights up.

When you put a CD-RW disc in the disc tray, "CD-RW" lights up.

The TOC indicator

When you put an unfinalized CD-R or CD-RW in the disc tray, "TOC" lights up.

For details on finalizing, refer to page 29, and page 30 for unfinalizing.

The CD TEXT indicator

When you put a CD containing a CD text in the disc tray, "CD TEXT" lights up.

When "CD TEXT" is framed in red in the display of DECK B, CD TEXT information is not recorded. In this case, finalize the disc to record the information.

If you remove the disc or turn off the power before finalizing, CD TEXT information is erased.

If you try to open the disc tray before finalizing, "TEXT Edited" appears. You can open the disc tray if you press OPEN/CLOSE while the message is displayed.

Locating a Specific Track

You can quickly locate any track while playing a disc by using the AMS (Automatic Music Sensor) dial on the deck, ◀◀ and ▶▶ buttons on the remote, or number buttons on the remote.

When using the remote, set DECK A/DECK B to DECK A to operate DECK A, or to DECK B to operate DECK B.

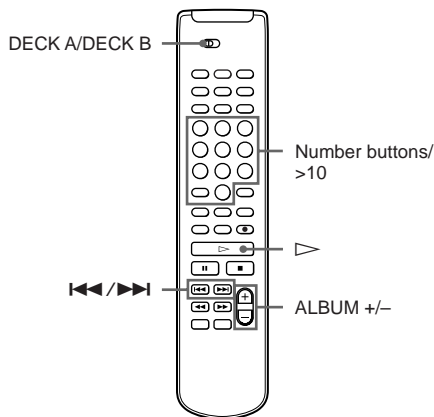
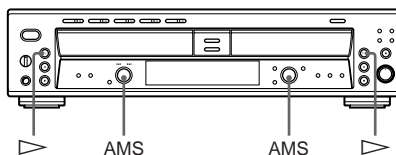

continued

To locate	Do the following:
The next or succeeding tracks	During playback, turn AMS clockwise while the ALBUM SELECT indicator in the display is turned off (or press ►► on the remote repeatedly) until you find the track.
The beginning of the current or preceding tracks	During playback, turn AMS counterclockwise while the ALBUM SELECT indicator in the display is turned off (or press ◀◀ on the remote repeatedly) until you find the track.
The next or succeeding album	Turn AMS clockwise while the ALBUM SELECT indicator in the display is turned on (or press ALBUM + on the remote).
The beginning of the preceding album	Turn AMS counterclockwise while the ALBUM SELECT indicator in the display is turned on (or press ALBUM - on the remote).
A specific track number or track name directly	In stop mode, turn AMS while the ALBUM SELECT indicator in the display is turned off (or press ◀◀/►► on the remote repeatedly) until you find the track number or track name, and press ▷.

Tip

To pause playing at the beginning of a track, turn AMS while the ALBUM SELECT indicator in the display is turned off (or press ◀◀/►► on the remote) after pausing playback.

Playing directly using the number buttons

You can playback a track directly by using the number buttons. Press the track number you want to play. When you select a track number over 10, press >10 first, then the corresponding number buttons.

Example:

To enter number 15, press >10, then 1 and 5.

Locating a Particular Point in a Track

You can locate a particular point in a track during playback or playback pause.

When using the remote, set DECK A/DECK B to DECK A to operate DECK A, or to DECK B to operate DECK B.

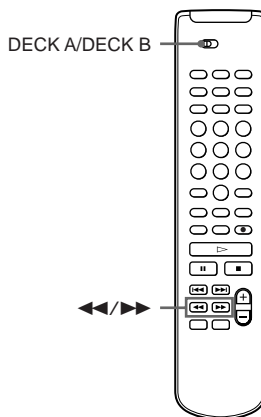

To locate a point	Do the following
While monitoring the sound	During playback, press and hold ◀◀ or ►► on the remote until you find the point.
While observing the display	During pause, press and hold ◀◀ or ►► on the remote until you find the point. You will not hear the sound during operation.

Tip

“-Over-” appears if the disc reaches the end. Turn AMS counterclockwise (or press ◀◀ or ◀◀ on the remote).

Note

Tracks that are only a few seconds long may be too short to scan using the search function. For such tracks, it is better to play the disc at normal speed.

Playing Tracks/Discs

Repeatedly (Repeat Play)

You can play tracks repeatedly in any play mode.

When using the remote, set DECK A/DECK B to DECK A to operate DECK A, or to DECK B to operate DECK B.

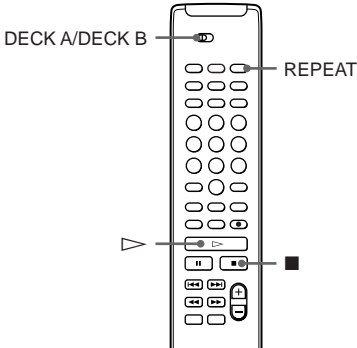

Repeating only the current track

While the track you want to repeat is being played, press REPEAT repeatedly until “REPI” lights up.

To stop Repeat Play

Press .

To cancel Repeat Play

Press REPEAT repeatedly until “REP” and “REPI” goes off.

Notes

- When the unit has repeated tracks in the same play mode five times, playback stops.
- When “ALL DISCS SHUF” (page 18) is selected, you cannot play all tracks on the disc repeatedly (for DECK A of RCD-W500C).
- The Repeat Play mode is canceled when you turn the unit off.

Repeating all tracks on the disc

Press REPEAT repeatedly until “REP” lights up in the display, and then press .

The unit repeats the discs/tracks/MP3 files as follows:

When the disc is played in	The deck repeats
ALL DISCS Continuous play (pages 8, 11)	All tracks on all discs.
1 DISC Continuous play (pages 8, 11)	All tracks on the current disc.
ALBUM (page 11)	All MP3 files of the current album.
1 DISC SHUF (for DECK A of RCD-W500C)/ SHUF (for DECK B of RCD-W500C and DECK A/B of RCD-W100) (page 18)	All tracks on the current disc in random order.
ALBUM SHUF (for DECK A) (page 18)	All MP3 files of the current album in random order.
Program Play (page 19)	All the same program.

Playing in Random Order (Shuffle Play)

You can have the unit “shuffle” tracks and play them in random order.

When using the remote, set DECK A/DECK B to DECK A to operate DECK A, or to DECK B to operate DECK B.

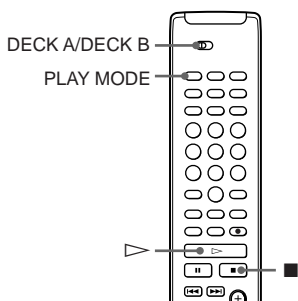
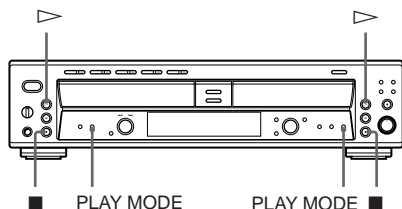

- 1 While the unit is stopped, press **PLAY MODE** repeatedly to select the Shuffle mode as follows:

When you select	The unit plays
ALL DISCS SHUF (for DECK A of RCD-W500C)	All tracks on all discs in random order.
1 DISC SHUF (for DECK A of RCD-W500C)	All tracks on the current disc in random order.
SHUF (for DECK B of RCD-W500C and DECK A/B of RCD-W100)	All tracks on the disc in random order.
ALBUM SHUF (for DECK A)	All MP3 files of the current album in random order.

- 2 Press .

“” appears in the display while the unit is “shuffling” the tracks, and the track is played.

To stop Shuffle Play

Press .

To cancel Shuffle Play

While the unit is stopped, press **PLAY MODE** until “SHUF” goes off.

Tip

To play from the beginning of the current track again, turn AMS counterclockwise while the **ALBUM SELECT** indicator is turned off (or press  on the remote). You cannot go back to tracks that have already been played.

Notes

- If “ALL DISCS SHUF” is selected in the “REP” setting, “REP” is cancelled (for DECK A of RCD-W500C).
- You cannot change the **PLAY MODE** during playback.
- You can use “ALBUM SHUF” only for discs with MP3 files.
- The play mode setting is canceled when you turn the unit off.

Creating Your Own Program (Program Play)

You can specify the playback order of the tracks and MP3 files on a disc to create your own programs containing up to 25 steps.

When using the remote, set DECK A/DECK B to DECK A to operate DECK A, or to DECK B to operate DECK B.

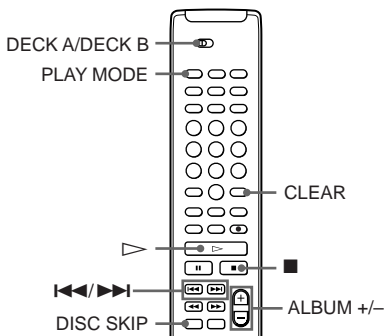
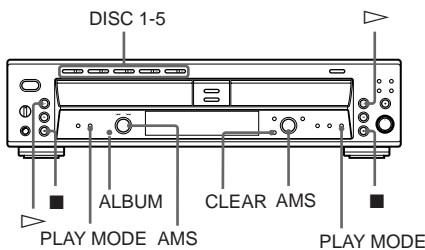

1 While the unit is stopped, press **PLAY MODE** repeatedly until “PGM” lights up in the display.

2 For **DECK A** of **RCD-W500C**, press one of the **DISC 1-5** buttons (or **DISC SKIP** on the remote) to select the desired disc number.

3 Turn **AMS** (or press **◀▶** on the remote) to select the desired track number, then press **AMS** (or **PLAY MODE**).

To program MP3 files, press **ALBUM** until **ALBUM SELECT** indicator in the display lights up, then turn **AMS** (or press **ALBUM +/-** on the remote) to select the desired album title.

Press **ALBUM** until **ALBUM SELECT** indicator in the display turns off, turn **AMS** (or press **◀▶** on the remote) to select the desired track number, then press **AMS** (or **PLAY MODE**).

4 To program additional tracks, repeat step 3 (steps 2 to 3 for **DECK A** of **RCD-W500C**).

5 Press **▷** to start **Program Play**.

The unit starts playing tracks in the programmed order.

To program all tracks on the selected disc (**DECK A** of **RCD-W500C** only) or album (**DECK A** only) After displaying the first track number in step 3, turn **AMS** counterclockwise (or press **◀◀** on the remote) to select “AL” instead of a track number. (You cannot program all tracks on the disc for MP3 files.)

To stop **Program Play**

Press **■**.

To cancel **Program Play**

Press **PLAY MODE** repeatedly until “PGM” goes off.

To erase the last programmed track

Press **CLEAR**. (Press **CLEAR** on the remote for **DECK A**.) Each time you press the button, the last programmed track is erased.

Tips

- You can also select the track number using the number buttons on the remote in step 3 above.
- The program remains even after **Program Play** ends. When you press **▷**, you can play the same program again.
- To check the total number of the programmed tracks, press **TIME** while the unit is stopped.

Notes

- You cannot create a program containing tracks from both **DECK A** and **DECK B**.
- “Step Full!” appears in the display when you program over 25 steps. Erase the unnecessary tracks to enter other tracks.
- The program is erased when you turn the unit off.
- If the total time of the program exceeds 99 minutes 59 seconds, “--:--” appears in the display.
- You cannot change the **PLAY MODE** during playback.
- If you program an MP3 track, “--:--” appears in the display. (The total playing time does not appear for MP3 files.)

Before Recording

About recordable discs

- A recordable disc is an audio CD-R or Audio CD-RW with the following logo.



- Audio CD-Rs are recordable only one time. Audio CD-RWs are recordable for multiple times. See page 7 for details.

About finalization

- Finalization is a final editing process that allows recorded CD-Rs and CD-RWs to be played in other players.
- Once a CD-R has been finalized, the recorded material cannot be changed. The recorded material on a CD-RW can be altered even after finalizing it. See page 29 for details.
- Unfinalized discs can only be played back on DECK B of this unit. See page 7 for details.

About the Serial Copy Management System

- The Serial Copy Management System allows you to make only a single copy of a digitally recorded source. This unit conforms to the Serial Copy Management System.
- You cannot perform a digital recording from a digitally recorded CD-R or CD-RW. In this case, make analog recording.

About recording MP3 files

- MP3 files are converted to audio CD format before being recorded to the disc. Thus the amount of data may increase too much to record on a single disc.
- As this unit recognizes the copyright information for MP3 files, there are following restrictions.
 - You can perform only Normal speed Synchro-Recording. You cannot make a manual recording.
 - The digital data is converted to analog data, then recorded. You cannot make direct digital recordings.
 - You cannot adjust the recording level.
- The minimum length of CD-DA is 4 seconds. Therefore, the number of tracks made by the Synchro-Recording may differ from the original disc.
- When recording from DECK A to DECK B, the play and record times shown in the display may be different. This does not affect the recording.

Automatic conversion of digital sampling rates

A built-in sampling rate converter automatically converts the sampling frequency of various digital sources to the 44.1 kHz sampling rate. This allows you to monitor and record sources such as 32 kHz or 48 kHz DAT tape or satellite broadcasts.

Types of Recording

The following types of recordings are possible, depending on the audio source. For details on each operation, see the reference pages.

		Automatic Finalization	Additional Recording	CD-TEXT Copy	Recording Level
When recording from DECK A					
Make-Disc Synchro-Recording*¹ (Make Disc On) Record all tracks on the selected disc in the original order.	High-Speed Synchro-Recording*² (page 23) Record in high-speed. You cannot hear the sound while recording.	○	×* ³	○	Same as original
	Normal speed Synchro-Recording (page 24) Record in normal speed while monitoring the sound.				
Synchro-Recording (Make Disc Off) Record from one disc (or several discs for RCD-W500C) in the order you want. You can also record in programmed order.	High-Speed Synchro-Recording*²	×	○	×	
	Normal speed Synchro-Recording				
Manual Recording (page 25) Record by selecting or editing the tracks manually.		×	○	×	Adjustable with menu operation
When recording from the component connected to the DIGITAL OPTICAL IN jack					
Manual Recording (page 25)		×	○	×	Adjustable with menu operation
When recording from the component connected to the ANALOG IN jack					
Manual Recording (page 25)		×	○	×	Adjustable with REC LEVEL

*¹ Set “Make Disc” in the Setup Menu to “On” beforehand (page 35).

*² Even if you select High-Speed Synchro-Recording, the recording speed automatically changes to normal speed in the following cases.

- When the disc contains Serial Copy Management System information.
- When the play mode of DECK A is “PGM”.
- When the disc in DECK A contains MP3 files.

*³ Be sure to use a blank disc (that has not been recorded).

continued

Tips

- To play the recorded CD on DECK A or another CD player, perform finalization (page 29).
- To record your favorite tracks from the CDs in DECK A, make a program (page 19).
- If the track marks are not marked properly while making an analog recording from an external component, see page 28.
- To record from several discs, see page 25.

Notes on recording

- You cannot record over existing material. The unit automatically starts recording from the end of any existing material.
- Make sure that the remaining recordable time on the CD-R or CD-RW is longer than the playing time of a source CD, especially if you want to record all the tracks.
- If a message appears in the display, refer to “Messages” on page 36.
- Recording automatically stops if recording is paused for more than about 3 minutes.

Note on a copy protection

Some commercial CD may contain a copy protection code that will prevent the disc from being recorded. In this case, “Cannot Copy” and either “C12” or “C41” will appear alternately in the display.

Do not move the unit or disconnect the unit from power source in the following situation. Recording may not complete successfully.

- When “Finalize,” “Unfinalize,” “Erase,” or “OPC” appears in the display:
The unit is currently updating the table of contents (TOC).
- When “PMA Writing” appears in the display:
The unit is currently updating the track information.

Synchro-Recording a CD to CD-R or CD-RW

You can easily make digital recordings from a CD to a CD-R or CD-RW. Before recording, see page 20.

There are 2 types of Synchro-Recording.

Make-Disc Synchro-Recording (Make Disc On)

Records a CD in the original order of its track number regardless of the selected play mode, and finalizes the disc. Be sure to use a disc that has not been recorded. (“Blank Disc” should appear in the display when you put the disc in DECK B.)

To use Make-Disc Synchro-Recording, set “Make Disc” in the Setup Menu to “On” beforehand (page 35).

- CD text (if contained in the disc) is recorded automatically. You can label the disc name or track name (up to 70 characters each, and 40 tracks per disc).

Note

When DECK A is in the Program mode, Make-Disc Synchro-Recording is canceled regardless of the Setup Menu setting.

Synchro-Recording (Make Disc Off)

- After recording, you must finalize the disc. Until the disc is properly finalized, it cannot be played on any CD players. See “Finalizing a CD-R or CD-RW” on page 29.
- CD text contained in the disc is not automatically recorded on the disc. To label tracks/discs, see “Labeling Tracks/Discs” (page 32).

Notes

- You cannot pause recording in Synchro-Recording.
- If Repeat Play is selected, it is automatically canceled.
- If Shuffle Play is selected, it is automatically canceled.
- The following functions do not work while Synchro-Recording:
 - Silent Pause function
 - Level Sync function
 - Manual Track Making function
 - Fade-in, Fade-out recording
 - Recording level adjustment (the recording level is set to the same as original disc)
- During Synchro-Recording, the Direct Recording function is turned on regardless of the Setup Menu setting.
- When copying a disc digitally recorded under control of the Serial Copy Management System (SCMS), the unit automatically select the analog recording. High speed recording changes to normal speed recording. For details on SCMS, see page 20.
- When copying a commercial music CD contains copy protection code, the unit automatically select the analog recording. High speed recording changes to normal speed recording.
- SBM function is available only for analog recordings (page 34).
- You cannot stop recording when finalizing in Make-Disc Synchro-Recording.

High-Speed Synchro-Recording

You can easily make digital recordings from a CD to a CD-R or CD-RW, faster than normal speed Synchro-Recording. You cannot monitor the recorded signal while recording. To use Make-Disc Synchro-Recording, set “Make Disc” in the Setup Menu to “On” beforehand (page 35).

When using the remote, set DECK A/DECK B to DECK B.

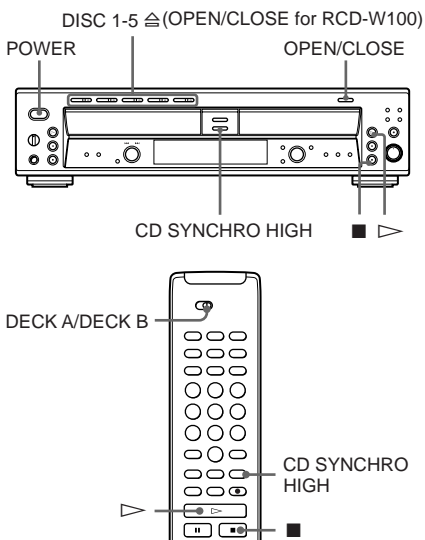

- 1 Press **POWER**.
- 2 Press **OPEN/CLOSE** of **DECK B** and place a recordable CD-R or CD-RW on the disc tray. Press **OPEN/CLOSE** of **DECK B** again to close the disc tray.

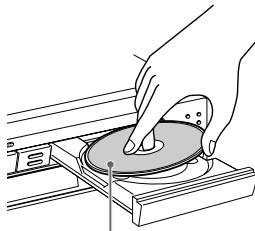

With the label side up

“TOC Reading” appears. The unit starts to read the TOC (Table of Contents) data and shows the type of the disc on the deck in the display.

continued

3 Press OPEN/CLOSE on DECK A (one of the DISC 1-5 $\hat{=}$ buttons for RCD-W500C) and place a CD on the disc tray. Press OPEN/CLOSE (or $\hat{=}$) on DECK A again to close the disc tray.

When you perform Make-Disc Synchro-Recording, the current disc in DECK A is used to record.

When you perform Synchro-Recording, you can choose the disc which you want to record, and the play mode.

If you select "ALL DISCS" even though you want to record only one disc, discs you did not intend to record may be recorded.

4 Press CD SYNCHRO HIGH.

DECK B stands by for recording, and DECK A stands by for playing.

5 After "New Track" appears in the display, press \blacktriangleright on DECK B to start recording.

High-Speed Synchro-Recording starts. DECK A and DECK B automatically stop after recording.

To stop recording

Press \blacksquare .

Notes

- When you make Synchro-Recording in programmed order, the recording speed automatically changes to Normal speed. You can perform only Normal speed Synchro-Recording.
- If you select "ALL DISCS" even though you want to record only one disc, discs you did not intend to record may be recorded.

Normal speed Synchro-Recording

The disc is recorded at the same speed as the playing CD. You can hear the sound during recording. To use Make-Disc Synchro-Recording, set "Make Disc" in the Setup Menu to "On" beforehand (page 35).

When using the remote, set DECK A/DECK B to DECK B.

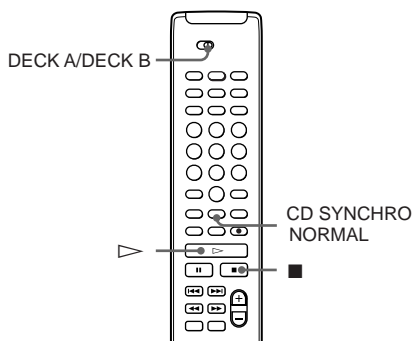
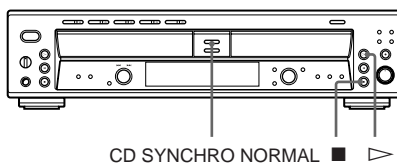

1 Do steps 1 to 3 of "High-Speed Synchro-Recording" on page 23.

2 Press CD SYNCHRO NORMAL.

DECK B stands by for recording, and DECK A stands by for playing.

When you place a CD-R or CD-RW in the deck, the unit optimizes itself for the best possible recording and "OPC" appears temporarily in the display.

If "Not Blank" appears, make sure that the blank disc is placed correctly.

3 After “New Track” appears in the display, press **▷** on DECK B to start recording.

Synchro-Recording starts. DECK A and DECK B will automatically stop after recording.

To stop recording

Press **■**.

To record only your favorite CD tracks

You can record only your favorite CD tracks using Program Play. Between steps 1 and 2, perform steps 1 to 4 of “Creating Your own Program (Program Play)” (page 19).

Note

When Program Play is selected, you cannot perform Make-Disc Synchro-Recording.

To record from several discs (RCD-W500C only)

In step 1, set the play mode to “ALL DISCS” or “PGM” and program the discs you want to record, then proceed to step 2.

Notes

- When the play mode is set to “ALL DISCS”, the recording starts from the disc whose indicator lights in green. Then the following discs are recorded. (After Disc 5, Disc 1 is selected).
- If you select “ALL DISCS” even though you want to record only one disc, discs you did not intend to record may be recorded.

Recording on a CD-R or CD-RW Manually

You can start recording from the end of the existing material. Before recording, see page 20.

When using the remote, set DECK A/DECK B to DECK B.

- After recording, you must finalize the disc. Until the disc is properly finalized, it cannot be played on any CD players. See “Finalizing a CD-R or CD-RW” on page 29.

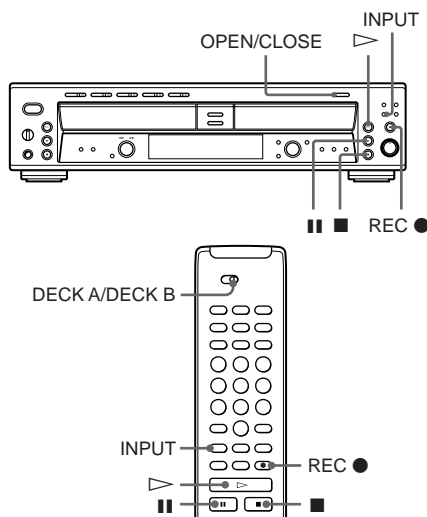

- 1 Turn on the amplifier and the sound source, and then select the sound source on the amplifier.
- 2 Press OPEN/CLOSE of DECK B and place a recordable CD-R or CD-RW on DECK B. Press OPEN/CLOSE again to close the disc tray.



With the label side up

3 Press INPUT repeatedly to select the input connector.

To record through	Turn on the indicator
DIGITAL OPTICAL IN	OPT*
ANALOG IN	ANALOG*

* If a disc is playing on DECK A, stop playback.

To record the disc in DECK A, turn off “OPT” and “ANALOG.”

4 Press REC ●.

DECK B stands by for recording.

5 Adjust the recording level, if necessary.

For details, see “Adjusting the Recording Level” on page 27.

6 Press ▷.

7 Start playing the sound source you want to record.

To pause recording

Press ■. To resume recording, press the button again or press ▷.

Note

Whenever you pause recording, a new track number is added. If you paused recording while recording, the track number increases by one and recording continues on the new track when recording is resumed.

To stop recording

Press ■.

“PMA Writing” appears while updating the information of the disc before stopping the recording.

To play from the beginning of the disc after recording

1 Press ■ again while the unit is stopped.

2 Press ▷.

The unit starts playing from the first track.

Notes

- If you press REC ● during recording, you can add a track number (page 28). The track must be longer than 4 seconds.
- When recording from more than one disc manually, the silence between tracks may increase when changing discs. To prevent this, use Synchro-Recording. (RCD-W500C only)
- This unit uses the Serial Copy Management System, which allows only first-generation digital copies to be made of premastered software via the unit’s digital input. Therefore you may not be able to record a CD-R or CD-RW digitally through the DIGITAL OPTICAL IN jack, depending on the content being recorded.
- Because of the restriction of the Serial Copy Management System (SCMS), you may not be able to make digital recordings. In this case, use analog recording through the ANALOG IN jack when you record from other units. Or use Synchro-Recording when you record from DECK A. (The recording mode is automatically changed to analog recording.)
- You cannot make manual recordings of MP3 files.
- While recording the source with “OPT” or “ANALOG” selected, you cannot play a disc on DECK A.

Adjusting the Recording Level

Adjusting the recording level for digital recording

You can adjust the recording level using the Setup Menu. (For details, see “Using the Setup Menu” on page 35.)

When using the remote, set DECK A/DECK B to DECK B.

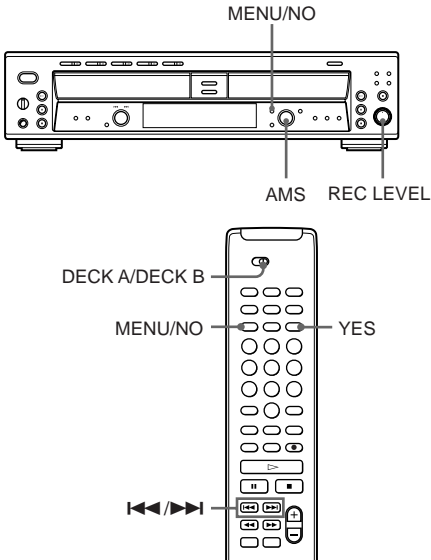

- 1 Do steps 1 to 4 of “Recording on a CD-R or CD-RW Manually” on page 25.
- 2 Play the portion of the sound source with the strongest signal level.
- 3 Press MENU/NO.
- 4 Turn AMS (or press **◀▶** on the remote) to select the program source.

To select	Display
DECK A	DECK A Lvl
a component connected to the DIGITAL OPTICAL IN jack	Optical Lvl

- 5 Press AMS (or YES).

- 6 While monitoring the sound, turn AMS (or press **◀▶** on the remote) to adjust the recording level, then press AMS (or YES).

Adjust the recording level within a range of $-\infty$ dB to +18 dB, so that the OVER indication of the peak level meters does not light red.

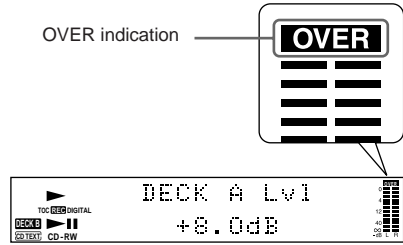

- 7 Press MENU/NO.
- 8 Stop playing the sound source.
- 9 To start recording, do steps 6 and 7 of “Recording on a CD-R or CD-RW Manually” on page 25.

Note

You cannot change the digital optical output level even if you adjust the recording level for digital recording.

Adjusting the recording level for analog recording

Turn the REC LEVEL control on the front panel. Adjust the recording level so that the OVER indication on the peak level meters does not light up.

Note

You can adjust the recording level while recording, not while playing a disc in DECK B.

- 5 Press AMS (or YES).

Marking Track Numbers While Recording

You can mark track numbers either manually or automatically. By marking track numbers at specific points, you can quickly locate the points later using the AMS Function or Editing Functions.

When using the remote, set DECK A/DECK B to DECK B.

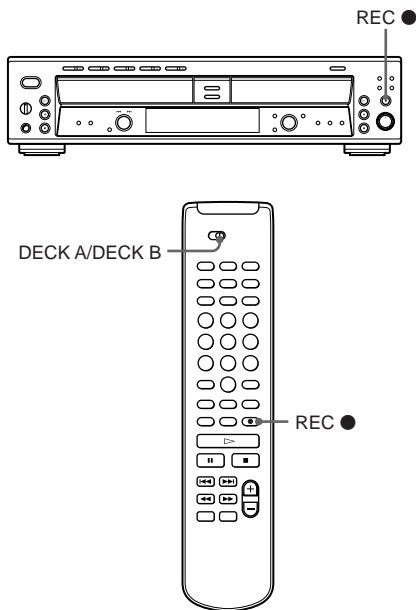

Marking track numbers automatically (Track Marking Function)

The unit adds track marks differently in the following cases:

- When you make a Synchro-Recording (page 22)
The unit marks track numbers automatically under the control of DECK A.
- When recording from DECK A, or from a CD or MD connected through the DIGITAL OPTICAL IN jack (with "OPT" selected by the INPUT button)
The unit marks track numbers automatically according to the information contained in the source being recorded. However, the unit may not automatically mark track numbers when recording from some CD players and multi disc players.
- In all other cases

When "Track Mark" is set to "LSync" in Setup Menu, the unit marks a new track number whenever the signal drops to the specified level* or below for about 1.5 seconds or longer, then rises to a specified level.

* The initial setting is -50 dB.

To turn off the Track Mark Function
While the unit is stopped, set "Track Mark" in Setup Menu to "Off." For details, see "Using the Setup Menu" (page 35).

To change the trigger level for Track Marking Function (Level Sync function)
While the unit is stopped, select "LSync Lvl" in the Setup Menu and set the level between -72 dB and -20 dB. For details, see "Using the Setup Menu" (page 35).

Marking track numbers manually

You can mark track numbers at any time while recording. Press REC ● at the point you want to add a track mark.

Notes

- You cannot mark track numbers manually during Synchro-Recording.
- Track length must be at least 4 seconds to mark track numbers manually.

Fading In and Out recording (Rec Fader)

You can gradually increase the recording level at the beginning of a recording (fade-in recording) or decrease the recording level at the end of a recording (fade-out recording).

This function is convenient when you do not want the track to start or end abruptly.

Before using the remote, set DECK A/DECK B to DECK B.

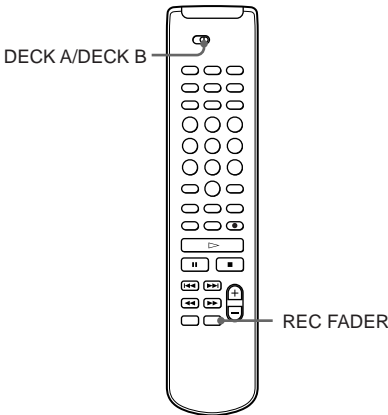

Notes

- Fading lasts for 5 seconds.
- You cannot change the digital optical output level even if you make fade-in/fade-out recording.

Fade-in recording

During recording pause, press REC FADER at the point where you want to start fade-in recording.

“Fade In” flashes in the display, and recording starts.

Fade-out recording

During recording, press REC FADER at the point where you want to start fade-out recording.

“Fade Out” flashes in the display, and the unit fades out and changes to recording pause.

Finalizing a CD-R or CD-RW

Finalizing completes the recording of a disc. It enables you to play the disc on DECK A of this unit or other players. (The CD-RW compatible player for CD-RW playback.) When a recording is finished, a CD-R or CD-RW must be finalized. Once that is done, a CD-R cannot be added or erased to. CD-RWs are locked once they are finalized, and must be unfinalized to permit additional recording or erasure.

When using the remote, set DECK A/DECK B to DECK B.

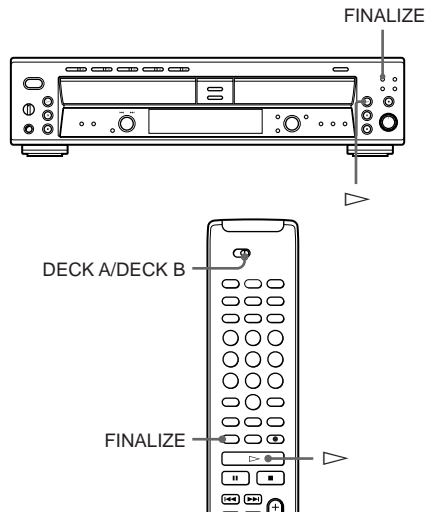

1 Place a CD-R or CD-RW that has not been finalized in DECK B.

Make sure that “TOC” appears in the display. If a finalized CD is loaded, “TOC” does not appear.

2 Press FINALIZE while the unit is stopped.

Finalizing enters standby mode.

continued

3 Press \triangleright (or YES).

Finalizing starts. During finalizing, “Finalize” appears in the display and the remaining time for finalizing (may not be accurate) appears. When the finalizing process is finished, the total track number and total playing time appears in the display and the TOC (red) indicator goes off.

Notes

- Once the finalizing process starts, you cannot stop in the middle of the process.
- Do not turn off the unit or disconnect the unit from the power source in the middle of the finalizing process. Recording will not be complete successfully, and you will not be able to play back the recorded tracks.
- An unfinalized disc can be played back only in DECK B.
- You cannot finalize the disc while playing a disc on DECK A.

Unfinalizing a CD-RW

A finalized CD-RW is neither recordable nor rewritable. If you want to add new tracks or erase tracks, you must first unfinalize the disc.

When using the remote, set DECK A/DECK B to DECK B.

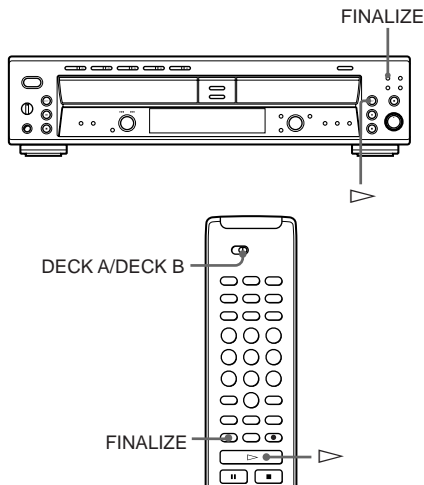

1 Place a finalized CD-RW in DECK B.

Make sure that “TOC” does not appear in the display. If an unfinalized CD is loaded, “TOC” appears.

2 Press FINALIZE while the unit is stopped.

Unfinalizing enters standby mode.

3 Press \triangleright (or YES).

Unfinalizing starts. During unfinalizing, “Unfinalize” appears in the display and the remaining time for unfinalizing (may not be accurate) appears. When the unfinalizing process is finished, the total track number and the total playing time appears in the display and the TOC (red) indicator lights up.

Notes

- Once the unfinalizing process was started, you cannot stop in the middle of the process.
- Do not turn off the unit or disconnect the unit from the power source in the middle of the unfinalizing process.
- If the disc contains CD-TEXT information stored on the disc before unfinalizing, it will be erased when the disc tray is opened or when the power is turned off.
- You cannot unfinalize the disc while playing a disc on DECK A.

Erasing Tracks of a CD-RW

You can erase tracks recorded on a CD-RW. This process starts with the last track on the disc.

Before erasing the track, make sure that the disc is not finalized. If the disc is finalized, follow the instructions for “Unfinalizing a CD-RW” (page 30).

When using the remote, set DECK A/DECK B to DECK B.

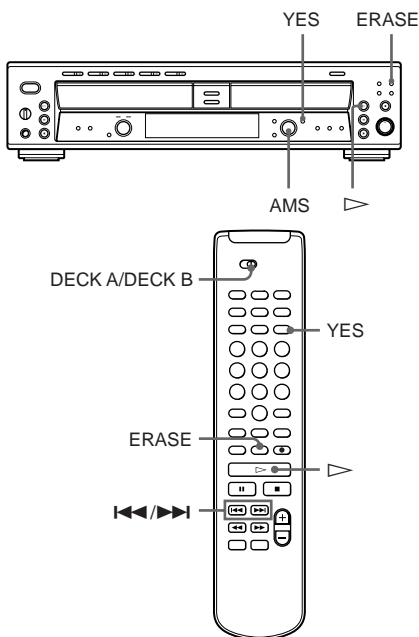

4 Turn AMS (or press **I◀◀/▶▶I** on the remote) to select the first track you want to erase.

5 Press **▷** (or YES).

Erasing starts from the last track. During erasing, “Tr Erase” appears in the display and the remaining time for erasing the last track (may not be accurate) appears. When this process is finished, the total track number and the total playing time appears in the display.

To erase all tracks

1 Place a CD-RW that has not been finalized in DECK B.

2 Press ERASE repeatedly until “Disc Erase?” appears in the display while the unit is stopped.

3 Press **▷** (or YES).

Erasing starts. During erasing, “Disc Erase” appears in the display and the remaining time of erasing (may not be accurate) appears. When the entire disc is erased, “Blank Disc” appears.

Notes

- Once the erasing process has started, you cannot stop in the middle of the process.
- You can erase only from the last track.
- Do not turn off the unit or disconnect the unit from the power source in the middle of the erasing process.
- You cannot erase tracks while playing a disc on DECK A.

1 Place a CD-RW that has not been finalized in DECK B.

Make sure that “TOC” appears in the display. If a finalized CD is loaded, “TOC” does not appear.

2 Press ERASE while the unit is stopped.

“Tr Erase?” appears in the display.

3 Press YES.

The last track is selected.

To erase only the last track, go to step 5.

Labeling Tracks/Discs



You can create titles for tracks/discs for a recorded CD-R or CD-RW with capital and small letters, numbers, and symbols. You can enter a disc name of up to 70 characters, and a track name of up to 70 characters per track, for 40 tracks per disc.

Label the track/disc before finalizing it. You cannot label the track/disc on a finalized disc.

After labeling, you must finalize the disc before you remove the disc or turn off the unit.

Otherwise, the titles will be cleared.

When using the remote, set DECK A/DECK B to DECK B.

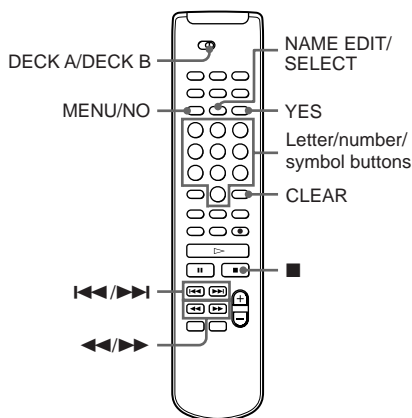

1 Place a CD-R or CD-RW disc that has not been finalized in DECK B.

2 Press NAME EDIT/SELECT while the unit is stopped.

"Name In?" appears in the display.

3 Press YES.

4 Press <</>> to select the disc or track you want to label.

When you label the disc name, select "Disc," and when you label the track name, select the track number.

5 Press YES.

A flashing cursor appears.

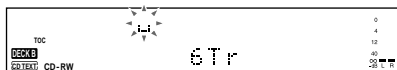

6 Press NAME EDIT/SELECT repeatedly to select the character type as follows:

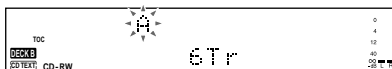

To select	Display
Capital letters and symbols*	Selected AB
Small letters and symbols*	Selected ab
Numbers	Selected 12

* You can use the following symbols in titles:

' - / , . () : ! ? & + < > _ = " ; # \$ % @ * `

To enter a space, press 10/0.

7 Press a letter/number/symbol button to enter a character.



To enter a number, press the number button you want.

To enter a letter or symbol,

1 Press the corresponding letter button repeatedly until the letter or symbol you want flashes. You can also enter a letter or symbol by pressing <</>> repeatedly. To select the symbol, press >> repeatedly after flashing "".

2 Press >>.

8 Repeat steps 6 and 7 until you have entered the entire title.

If you enter an incorrect character, press << or >> until the incorrect character starts flashing.

Press CLEAR to erase the incorrect character, then enter the correct one.

9 Press YES.

"Complete !" appears in the display for a few seconds and the track or disc is labeled. Finalize the disc before you remove the disc or turn off the unit. Otherwise, the titles will be cleared.

To cancel labeling
Press MENU/NO or ■.

Changing an existing title

- 1 Do steps 1 to 5 in “Labeling Tracks/ Discs” (page 32) to select the title you want to change.
- 2 Press and hold CLEAR until the current title is erased.
- 3 Do steps 6 to 8 of “Labeling Tracks/ Discs” (page 32) to enter the new title.
- 4 Press YES.

“Complete !” appears in the display for a few seconds and the track or disc is labeled.

Useful Tips for Recording

When using the remote, set DECK A/DECK B to DECK B.

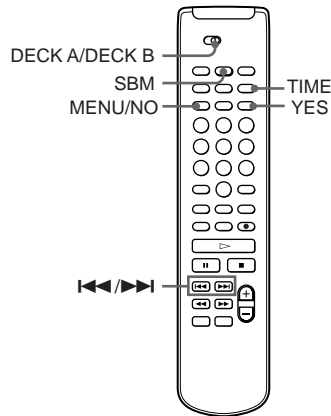
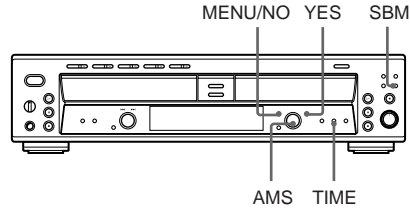

Checking the remaining recordable time on the CD-R or CD-RW

Press TIME repeatedly.

- Each time you press the button while the unit is stopped, the display alternates between total disc playing time and remaining recordable time on the CD-R or CD-RW (page 13).
- Each time you press the button while recording, the display alternates between the recording time of the current track and the remaining recordable time on the CD-R or CD-RW (page 14).

continued

Using the Silent Pause function

If there has been no sound input for about 30 seconds during recording, the unit pauses recording.

If the unit continues pausing for about 3 minutes after the Silent Pause Function activated, recording stops automatically.

Note that this function does not activate if the unit is Synchro-Recording from a CD on DECK A.

Tip

You can turn off the Silent Pause Function. For details, see "Using the Setup Menu" (page 35).

Using the Post Gap function

You can insert the silence of 2 seconds between the songs, when recording more than two tracks at once. The silence is inserted in the following situations.

- When recording is stopped.
- When the disc of DECK A changes to the next disc during Synchro-Recording (RCD-W500C only).

To use the function of adding Post Gap

Set "Post Gap" of the setup menu to "On" when the unit is stopped. For details, see "Using the Setup Menu" on page 35.

Using the SBM (Super Bit Mapping) function

When performing analog recordings (recording from ANALOG IN jack, or synchro-recording MP3 files), the SBM function enables you to record the equivalent of 24-bit high quality sound by mapping the initial 24-bit A/D conversion to 16-bit without reducing the sound quality. This is made possible by incorporating a noise-shaping filter in the 24-bit A/D converter of this unit, which has a frequency range designed to cover the range of human hearing.

Press SBM. The indicator lights up.

When you press the button again, the function is canceled and the indicator turns off.

Notes

- You cannot change the setting while recording.
- When performing digital recordings (recording from DIGITAL OPTICAL IN jack, or recording from DECK A), the SBM function is automatically canceled.

Recording the original sound from the program source (Direct Recording)

You can record audio as it is when recording a digital signals with 44.1 kHz sampling rates without going through the device's internal circuits. Set "Direct" in the Setup Menu to "On". For details, see "Using the Setup Menu" on page 35.

Notes

- When recording digital signals with sampling rates other than 44.1 kHz, the signal will automatically pass through the device's internal sampling rate converter before recording, even when "Direct" is set to "On".
- The recording level is set to the setting adjusted in the Setup Menu.
- During Synchro-Recording, the Direct Recording function works regardless of the Setup Menu setting.

Using the Setup Menu

You can make various settings on this unit by using the Setup Menu.

When using the remote, set DECK A/DECK B to DECK B.

- 1 Press **MENU/NO**.
- 2 Turn **AMS** (or press **◀▶** on the remote) to select the setup item, and press **AMS** (or **YES**).
- 3 Turn **AMS** (or press **◀▶** on the remote) to set the item, and press **AMS** (or **YES**).
- 4 Press **MENU/NO**.

To initialize an item's parameter
Press **CLEAR** after step 2.

Notes

- The menus you can use while the unit is stopped, playing, or recording differ.
- The setting is stored in memory even if you turn off the unit or disconnect the power.

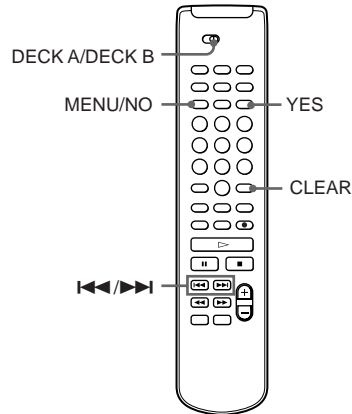
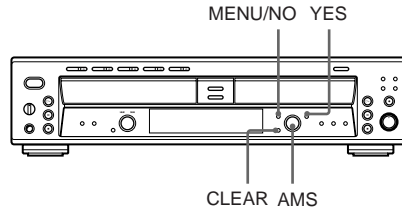

Menu items

Setup item	Function (reference page)	Parameters (Initial setting)
Make Disc	Sets whether Make-Disc Synchro-Recording is performed when using the CD SYNCHRO NORMAL or CD SYNCHRO HIGH buttons (page 22).	On/Off (Off)
DECK A Lvl	Adjusts the input level from DECK A (page 27).	-∞ dB to +18 dB (0.0 dB)
Optical Lvl	Adjusts the input level from the DIGITAL OPTICAL IN jack (page 27).	-∞ dB to +18 dB (0.0 dB)
Track Mark	Sets the Track Marking Function (page 28).	LSync/Off (LSync)
LSync Lvl	Changes the trigger level for Track Marking Function (page 28).	-72 dB to -20 dB in 2 dB increments (-50 dB)
Silent Pause	Sets the Silent Pause Function (page 34).	On/Off (On)
Direct	Sets the Direct Recording Function (page 34).	On/Off (Off)
Post Gap	Sets the function to add Post Gap (page 34).	On/Off (Off)

Messages

The following table explains the messages that appear in the display.

Message	Explanation
Blank Disc	A blank CD-R/CD-RW you have just bought or a CD-RW you have entirely erased is in the unit.
Check Disc	You are trying to record or edit a finalized disc or CD. Or you are trying to edit a CD-R.
Complete!	Editing has been completed successfully.
Data Disc	You are trying to record or edit a non audio CD-R/CD-RW. • Insert an audio CD-R/CD-RW.
Disc Full!	There is not enough time left on the CD-R/CD-RW or there are no recordable tracks available to complete a planned recording.
Erase	The ERASE function is operating.
Ex-Change (RCD-W500C only)	During CD playback, you remove and insert another CD.
Fade In	The FADE IN REC function is operating.
Fade Out	The FADE OUT REC function is operating.
Finalize	The FINALIZE function is operating.
Incomplete!	Editing has not completed successfully due to vibration of the unit or a dirty or scratched disc.
Initialize	The unit does not memorize the Setup Menu settings or the previous playback state.
Name Full!	The number of characters used for the track or disc names is beyond the maximum.
-NO DISC-	There is no disc in the unit.
No Name	There is no title.
Message	Explanation
Not Blank	You have tried the Make-Disc Synchro-Recording, with a disc that is not blank. • Use a blank disc for the Make-Disc Synchro-Recording.
OPC	OPC: Optimum Power Control The unit is optimizing itself for best possible sound.
OPC Over	The number of times OPC recording has been performed 90 times. • Stop the recording and finalize the disc.
-Over-	The playback of the last track is over. • Turn AMS counterclockwise (or press ◀◀ or ◀ on the remote).
PMA Writing	PMA: Program Memory Area A disc's information is being updated.
Push STOP!	You operate the unit not in the STOP mode. • Stop the unit, and then operate the unit again.
-Retry-	Recording or editing has been tried again.
Step Full!	The number of programmed tracks has reached the limit, and you cannot program any more tracks. • Before you program a new track, erase the current program and restart a new program procedure.
TEXT Edited	A disc whose text has been edited but has not been finalized is inserted, and OPEN/CLOSE has been pressed. • Finalize the disc, and then press OPEN/CLOSE to remove the disc. If you want to remove the disc before finalizing it, press OPEN/CLOSE again while "TEXT Edited" is displayed.
Unfinalize	The UNFINALIZE function is operating.

Self-diagnosis Function

When the self-diagnosis function is activated to prevent the player from malfunctioning, three character service numbers in a combination with a message appears in the display. In this case, check the following table.

Message	Explanation
C12/ Cannot Copy	<p>You are trying to record a disc that cannot be played back in DECK-A or with an external device, such as CD-ROM or VIDEO CD.</p> <ul style="list-style-type: none">• Remove the disc, and then insert a music CD for playback.
C13/ Rec Error	<p>Recording has not been completed successfully because of vibration.</p> <ul style="list-style-type: none">• Relocate the unit in a place free of vibration and restart the recording again. <p>The disc you try to record is excessively dirty (such as oil-stained or finger marked) or scratched. Or the disc is not normal.</p> <ul style="list-style-type: none">• Replace the disc with another one and restart the recording again.
C14/ TOC Error	<p>The unit did not read the TOC information.</p> <ul style="list-style-type: none">• Insert other discs.
C41/ Cannot Copy	<p>The sound source you are trying to record is a copy of a commercial music software. Or you are trying to record on a CD-R/CD-RW digitally.</p> <ul style="list-style-type: none">• Because of the restriction of the Serial Copy Management System, you cannot record copies of commercial music software or MP3 files on DECK A. Neither can you digitally record from a CD-R/CD-RW.• Use analog recording through the ANALOG IN jack when you record from other units. Or use Synchro-Recording when you record from DECK A. (The recording mode is automatically changed to analog recording.)

C71/
Din Unlock

If this message is displayed momentarily, this is not an error. It is caused by the digital signal during recording.

During recording of a digital sound source, the connecting cable has been disconnected or the player of the sound source has turned off.

- Connect the cable or turn on the digital player.

System Limitations

“TOC Reading” appears in the display for a long time

Regardless of the disc, “TOC Reading” appears in the display of DECK B longer than in that of DECK A. This is because, DECK B is a CD-R/RW writer and reads various version information while setting optimum recording condition.

Limitations when recording over an existing track

- The correct remaining recording time may not be displayed.
- The remaining recording time may be inaccurately displayed relative to the total recorded time.
- You can record up to 99 tracks.

Note

When you turn on the unit, you will hear some mechanical noise from the unit. This is not a malfunction.

Troubleshooting

If you experience any of the following difficulties while using the unit, use this troubleshooting guide to help you remedy the problem.

DECK A (the CD player section)

The player does not start playing.

- Insert a disc.
 - Place the disc properly.
 - Clean the disc (page 4).
 - Place the disc with the label side up.
 - Moisture condensation has formed inside the unit. Take the disc out and leave the unit turned on for about an hour until the moisture evaporates (page 4).
 - Press POWER to turn the unit on.
-

DECK A (MP3 playback)

MP3 files cannot be played back.

- You cannot play MP3 files on DECK B.
 - Recording was not performed according to the ISO 9660 level 1 or level 2 format, or the Joliet or Romeo in the expansion format.
 - The file extension “.MP3” is not added to the file name.
 - Files are not stored in MP3 format.
-

MP3 files take longer to play back than others.

- The following discs take a longer time to start playback.
 - a disc recorded with complicated tree structure.
 - a disc recorded in Multi Session.
 - a disc to which data can be added (non-finalized disc).
-

DECK B (the CD-R and CD-RW recording section)

The unit does not operate or operates poorly.

- The CD-R or CD-RW may be damaged. Replace the disc.
-

The player does not start playing.

- Place the CD-R or CD-RW with the label side up.
 - Moisture has formed inside the unit. Take the disc out and leave the unit in a warm place for several hours until the moisture evaporates (page 4).
 - Press POWER to turn the unit on.
 - Replace the CD-R or CD-RW with one that has been recorded.
-

The player does not start recording.

- The CD-R or CD-RW is finalized. Unfinalize (for CD-RW only) the disc (page 30) and try again.
 - Make connections properly to the sound source (page 6).
 - The sound source is not connected to the selected input connector. Select the correct input using the INPUT button (page 26).
 - The recording level is set too low. Adjust the recording level properly (page 27).
 - There has been a power failure or the AC power cord has been disconnected during recording. Data recorded to that point may be lost.
-

The sound has a lot of static.

Strong magnetism from a television or a similar device is interfering with operations. Move the unit away from any sources of strong magnetism.

Other

No sound is output.

- Make the connections properly (page 6).
 - Operate the amplifier properly.
 - When using the headphones, turn PHONE LEVEL to turn up the output level.
-

The remote does not operate the unit.

- Make sure that there are no obstacles between the unit and the remote.
 - Point the remote at the remote sensor on the unit.
 - Replace the batteries in the remote.
-

When you turn on the unit, you will hear some mechanical noise from the unit. This is not a malfunction.

After you have attempted the prescribed corrective actions

If the unit still does not operate properly, or if other problems not described above occur, turn off the unit, unplug it from the power outlet for a few minutes, then reinsert the plug into the power outlet.

Should any problem persist even after reinserting the power plug, consult your nearest Sony dealer.

Specifications

DECK A (the CD player section)

System	Compact disc digital audio system
Laser	Semiconductor laser ($\lambda = 780 \text{ nm}$) Emission duration: continuous
Playable discs	CD, CD-R, CD-RW
Frequency response	20 Hz – 20,000 Hz ($\pm 0.5 \text{ dB}$)
Signal to Noise Ratio	Over 98 dB during play
Wow and flutter	Below measurable limit

DECK B (the CD-R and CD-RW recording section)

System	Compact disc digital audio system
Laser	Semiconductor laser ($\lambda = 780 \text{ nm}$) Emission duration: continuous
Playable discs	CD, CD-R, CD-RW
Recordable discs	CD-R, CD-RW (for Audio)
Frequency response	20 Hz - 20,000 Hz ($\pm 0.5 \text{ dB}$)
Signal to Noise Ratio	Over 98 dB during play
Wow and flutter	Below measurable limit

Inputs

ANALOG IN (Phono jacks)	Impedance: 47 kilohms Rated input: 500 mVrms Minimum input: 250 mVrms
----------------------------	--

DIGITAL OPTICAL IN

(Square optical connector jack)	Optical wavelength: 660 nm
---------------------------------	-------------------------------

Outputs

ANALOG OUT (Phono jacks)	Rated output: 2 Vrms Load impedance: over 10 kilohms
-----------------------------	--

DIGITAL OPTICAL OUT

(Square optical connector jack)	Wavelength: 660 nm Rated output: -18 dBm
---------------------------------	---

PHONES (Stereo phone jack)	Load impedance: 32 ohms Rated output: 12mW
-------------------------------	---

General

Power requirements	
North American model:	120 V AC, 60 Hz
European model:	230 V AC, 50/60 Hz
Power consumption	25 W
Dimensions (approx.) (w/h/d) incl. projecting parts and control	430 × 108 × 399 mm (17 × 4 ³ / ₈ × 15 ³ / ₄ inch)
Mass (approx.)	RCD-W500C: 6.8 kg (15 lbs) RCD-W100: 6.0 kg (13 lbs 4 oz)

Supplied accessories	See page 6.
----------------------	-------------

Design and specifications are subject to change without notice.