



Quick Response Swing with Remote Control



Model Number: B0323, B3002

Please keep this instruction sheet for future reference, as it contains important information.

Adult assembly is required.

Tools needed for assembly: Phillips Screwdriver and Scissors (both not included).

Requires four "D" (LR20) **alkaline** batteries for swinging and sound operation; three "AA" (LR6) **alkaline** batteries for sound 'n lights tray operation; and three "AAA" (LR03) **alkaline** batteries for remote operation (all batteries not included).

Maximum Weight Limit: 24 lbs. (10.9 kg).

IMPORTANT! The maximum weight limit for this product is 24 lbs. If your child weighs less than 24 lbs., but is really active and appears to be able to climb out of the swing, immediately discontinue its use.

Discover what's possible™... www.fisher-price.com

WARNING

- To prevent falls, never use with an active child who may be able to climb out of the seat.
- Never leave child unattended.
- To prevent injury or death from falls or sliding out, always use restraint system. Never rely on the tray to restrain child.

CAUTION

This product contains small parts in its unassembled state. Adult assembly is required.

Occasionally a consumer may experience a problem with one of our products. If this should happen, please call us toll-free, rather than return this product to the store. Usually, we can solve the problem over the telephone or send you replacement parts. Please call Fisher-Price® Consumer Relations, toll-free at **1-800-432-5437**, 8 AM - 6 PM EST Monday through Friday. Hearing-impaired consumers using TTY/TDD equipment, please call 1-800-382-7470.

Or, write to:
Fisher-Price®
Consumer Relations
636 Girard Avenue
East Aurora, New York 14052

Parts

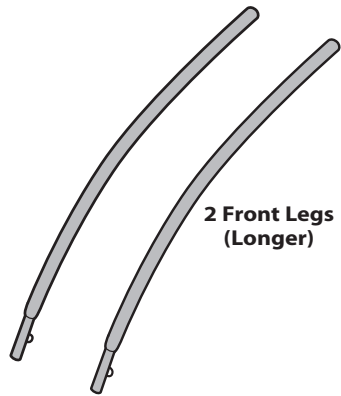

2 Front Legs (Longer)

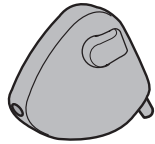

Housing

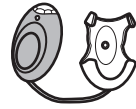

Remote Control and Holder



2 Accessory Bins



Motor Housing

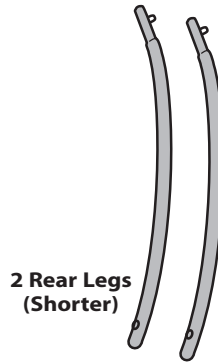

2 Rear Legs (Shorter)

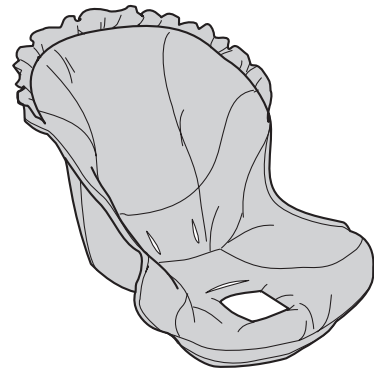

Pad

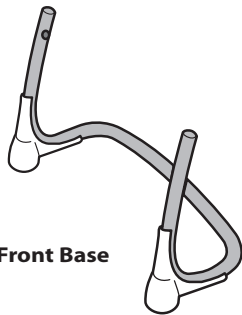

Front Base

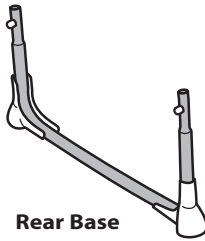

Rear Base

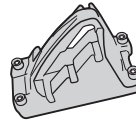

Bracket

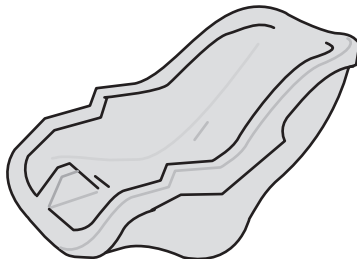

Seat with Restraint

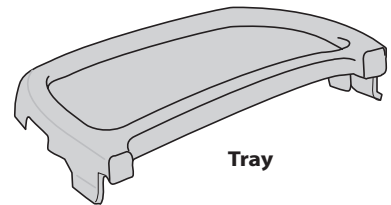

Tray



2 Seat Wire Caps

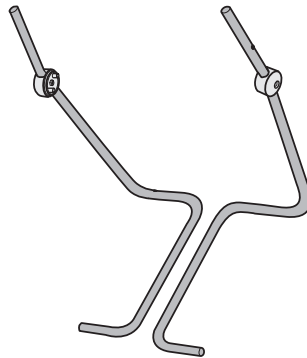

2 Seat Tubes



Seat Wire

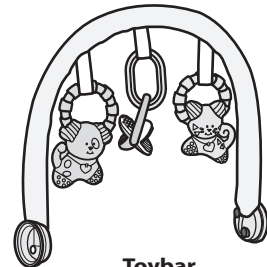

Toybar



3.5mm x 1.25cm Screw - 4 Shown Actual Size

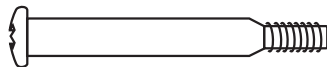

M4 Bolt - 1 Shown Actual Size

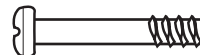

M4 Screw - 4 Shown Actual Size



#8 x 1 1/4" Screw - 6 Shown Actual Size

Assembly

IMPORTANT! Before assembly, inspect this product for damaged hardware, loose joints, missing parts or sharp edges. DO NOT use if any parts are missing or broken. Contact Fisher-Price® for replacement parts and instructions if needed. Never substitute parts.

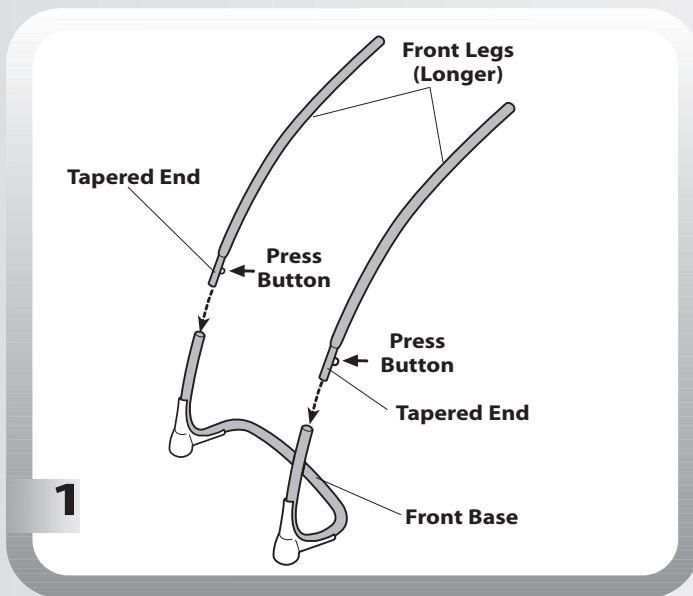

- Place the front base on a flat surface.
- Position a front leg (longer) so that the tapered end is downward, as shown.
- While pressing the button on one of the front legs, insert it into the front base. Push down on the front leg until the button “snaps” into the hole in the front base.
- Repeat this procedure to assemble the other front leg to the front base.

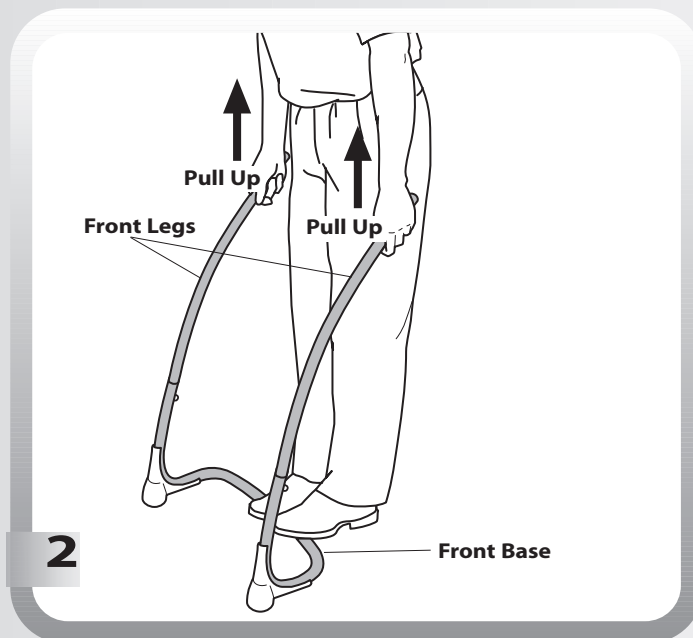

- While standing on the front base, pull the front legs up. The front legs should **remain secured** to the front base. If you can remove the front legs, you have not assembled them correctly to the front base. Reread and repeat assembly step 1.

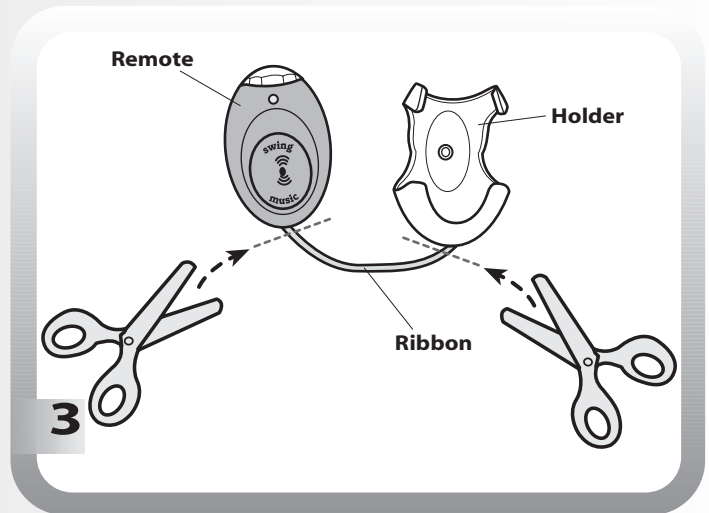

- Using scissors, remove the ribbon connecting the remote and the holder.

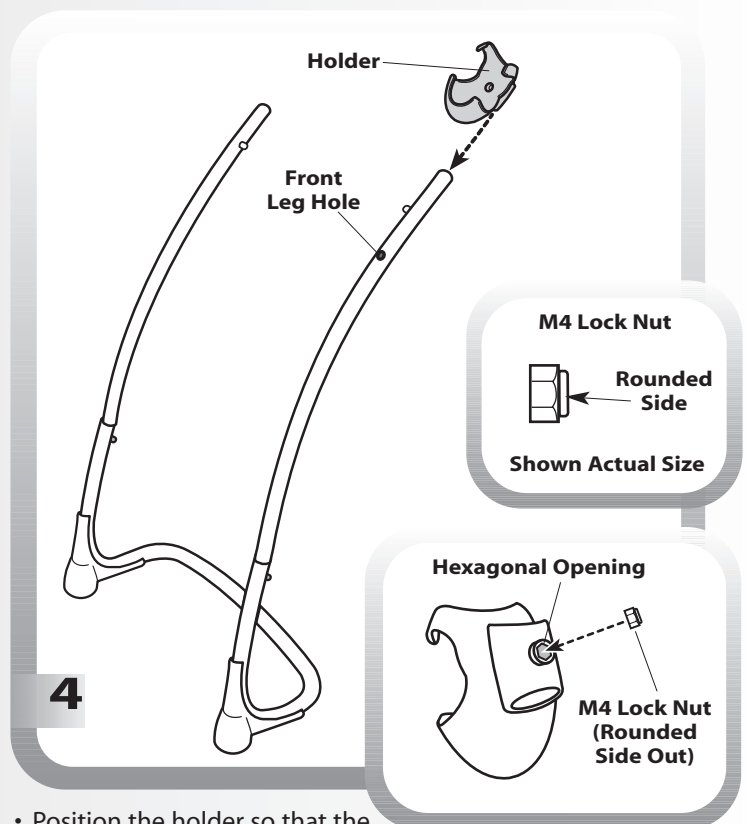

- Position the holder so that the open end faces forward, as shown.
- Slide the holder onto the front leg with a hole.

Hint: An M4 lock nut has been assembled to the holder at the factory. During shipment of this product, it may have fallen out. Check to be sure there is a lock nut in the hexagonal opening on the holder. If it has fallen out, fit the lock nut back into the hexagonal opening. Make sure the rounded side of the lock nut faces out.

Assembly

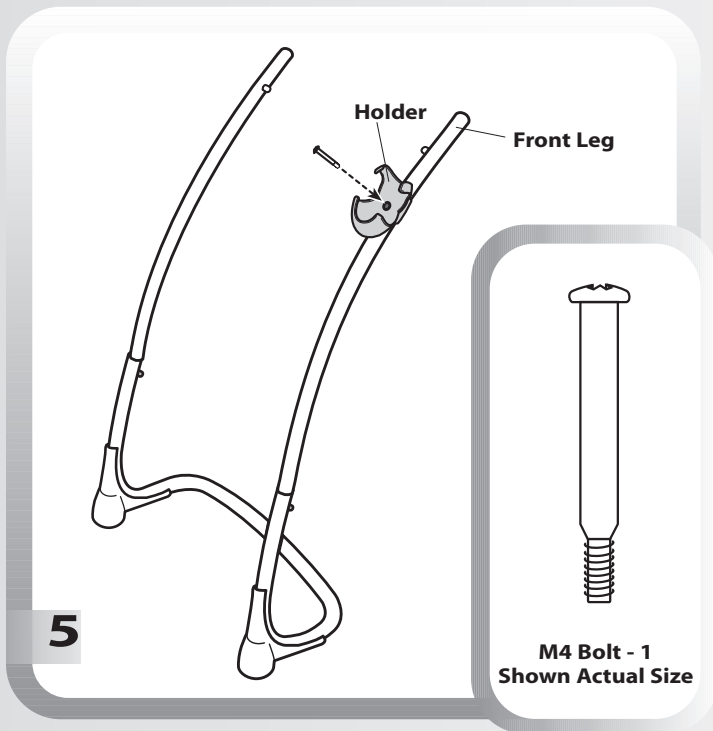

- Position the holder so that the hole in the holder aligns with the hole in the front leg.
- Insert the M4 bolt through the holder, front leg and into the lock nut.
- Tighten the bolt with a Phillips screwdriver. Do not over-tighten.

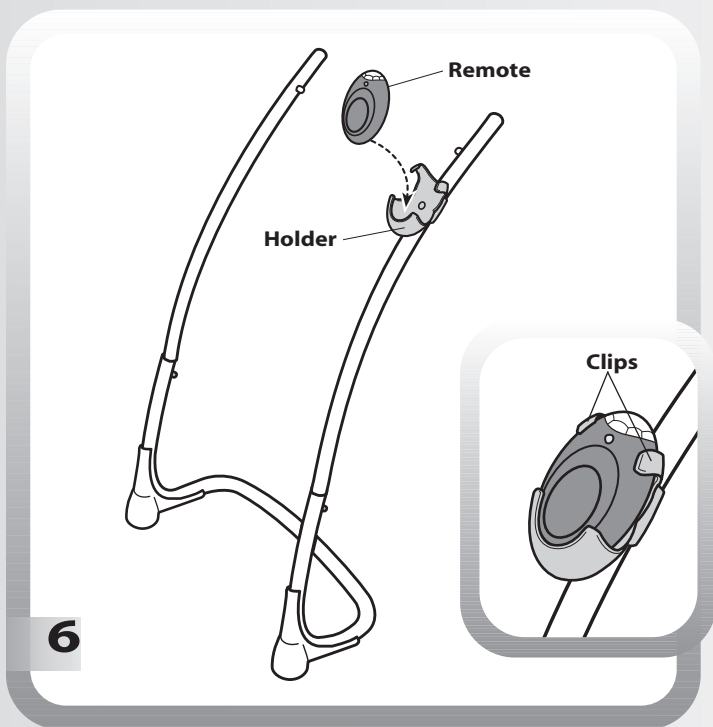

- Fit the bottom of the remote into the cupped portion of the holder.
- Push to “snap” the top of the remote under the holder clips.

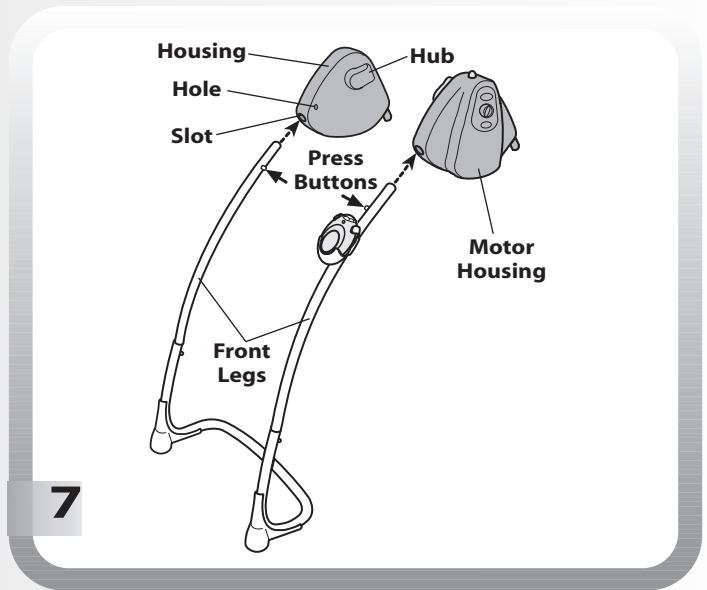

- Position the housing so that the hub is inward.
- While pressing the button on the top of a front leg, insert it into the housing slot, as shown. Push the front leg until the button “snaps” into the hole in the housing.
- Repeat this procedure to assemble the motor housing to the other front leg.
- Pull the front legs down to be sure they are secure in the housings. If you can remove them, you have not assembled them correctly. Please re-read and repeat this assembly step.

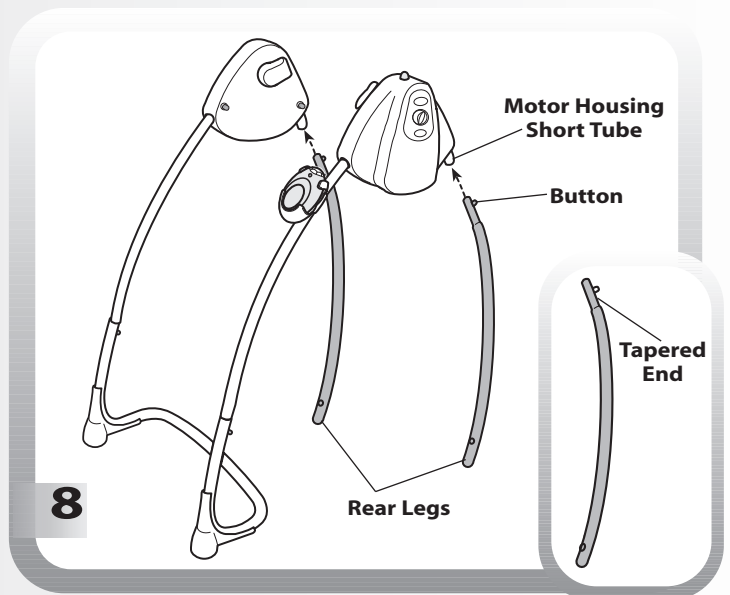

- Position a rear leg so that the tapered end is upright.
- While pressing the button on the top of the rear leg, insert it into the housing short tube, as shown. Push the rear leg until the button “snaps” into the hole in the short tube.
- Repeat this procedure to assemble the other rear leg to the motor housing short tube.
- Pull the rear legs down to be sure they are secure in the housings. If you can remove them, you have not assembled them correctly. Please re-read and repeat this assembly step.

Assembly

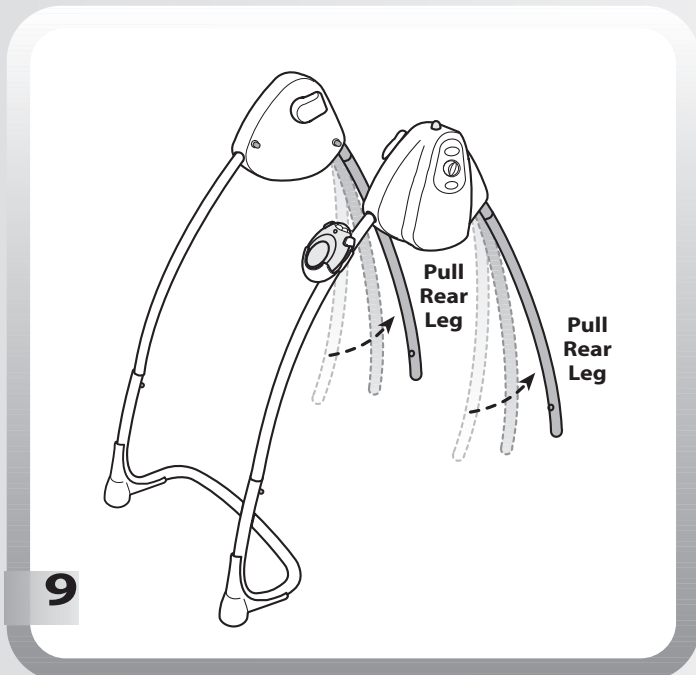

- Pull both rear legs out until they “snap” into place.

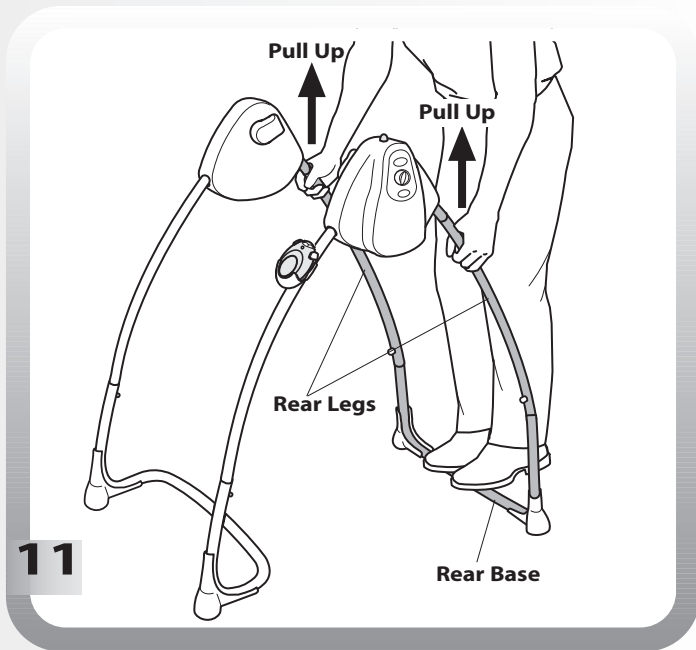

- While standing on the rear base, pull the rear legs up. They should remain secured to the rear base. If you can remove the rear legs, you have not assembled them correctly to the rear base. Reread and repeat assembly step 10.
- Set the frame assembly aside for Assembly step 21.

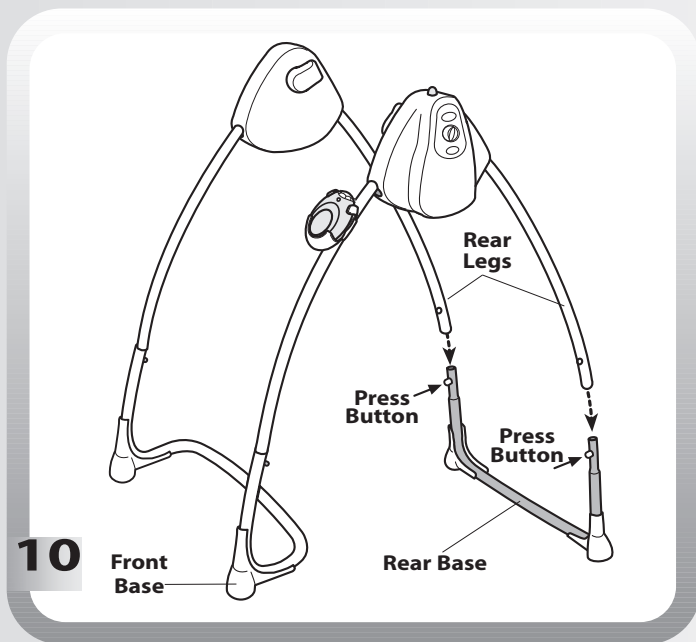

- Place the rear base on a flat surface so that the buttons face the front base.
- While pressing the buttons on each side of the rear base, fit the rear legs onto the rear base. Push the rear legs down until the buttons on the rear base “snap” into the holes in each rear leg.

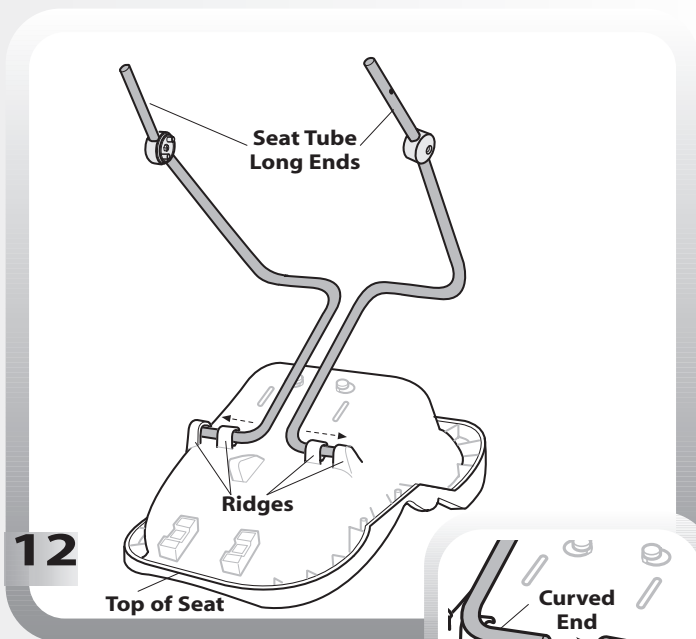

- Position the seat face down, with the top of the seat facing you.
- Position a seat tube so that the long end is upright and toward you and the curved end is toward the outside edge of the seat.
- Insert the curved end of the seat tube through the holes in the ridges on the seat back.
- Repeat this procedure to assemble the other seat tube to the seat.

Assembly

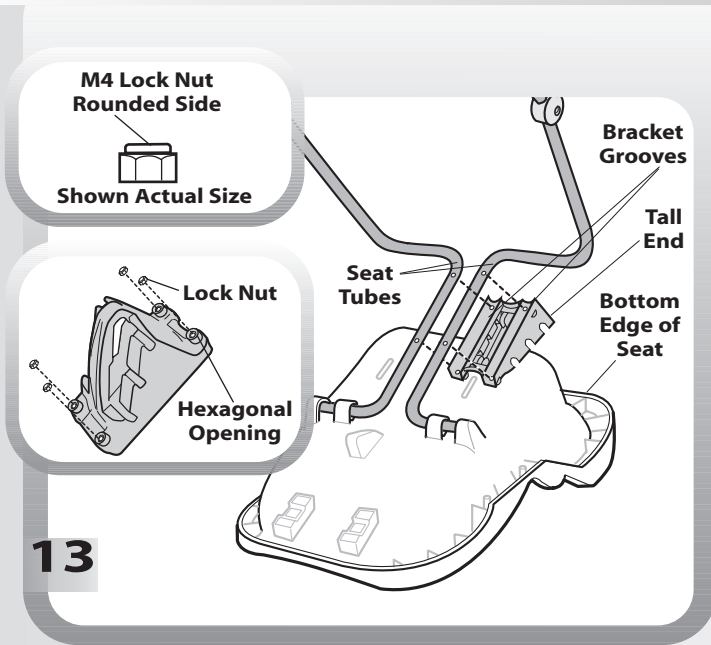

13

- Position the bracket so that the tall end is toward the bottom edge of the seat.

Hint: The M4 lock nuts have been assembled to the bracket at the factory. During shipment of this product, they may have fallen out. Check to be sure there is a lock nut in each hexagonal opening on the bracket. If one (or more) has fallen out, fit the lock nut into a hexagonal opening in the bracket. Make sure the rounded side of the lock nut is facing up.

- Fit the grooves on the bracket to the seat tubes, as shown.

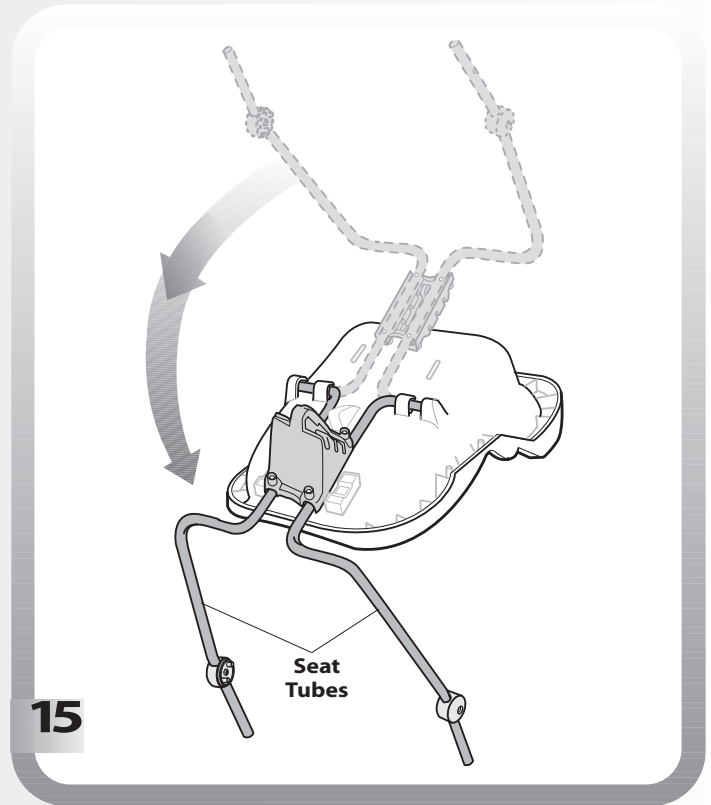

15

- Rotate the seat tubes down.

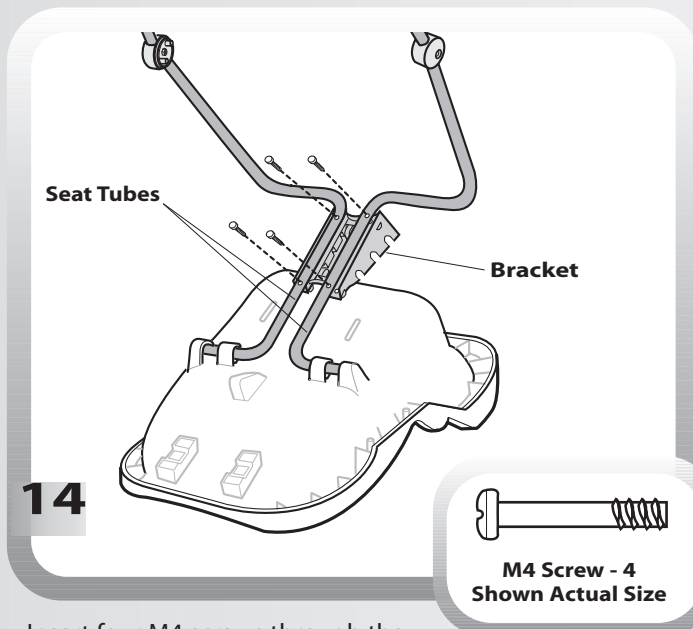

14

- Insert four M4 screws through the seat tubes, bracket and into the lock nuts.
- Tighten the screws with a Phillips screwdriver. Do not over-tighten.

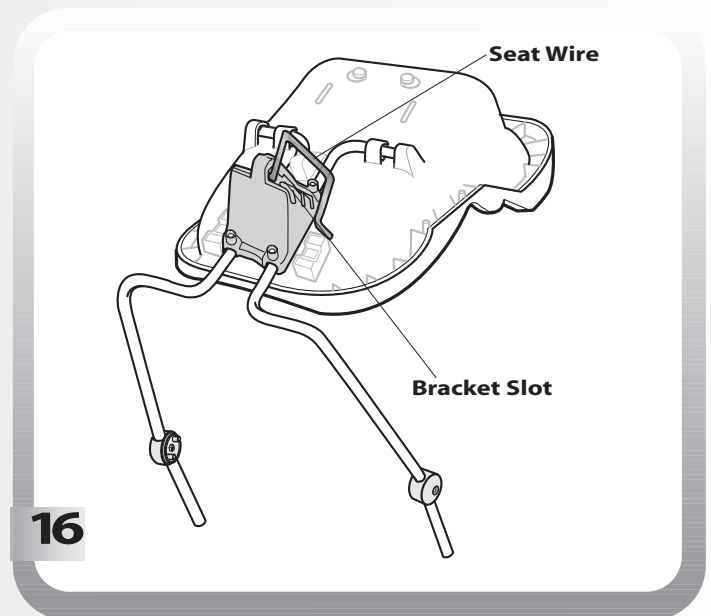

16

- Fit the seat wire through the slot in the bracket as shown.

Assembly

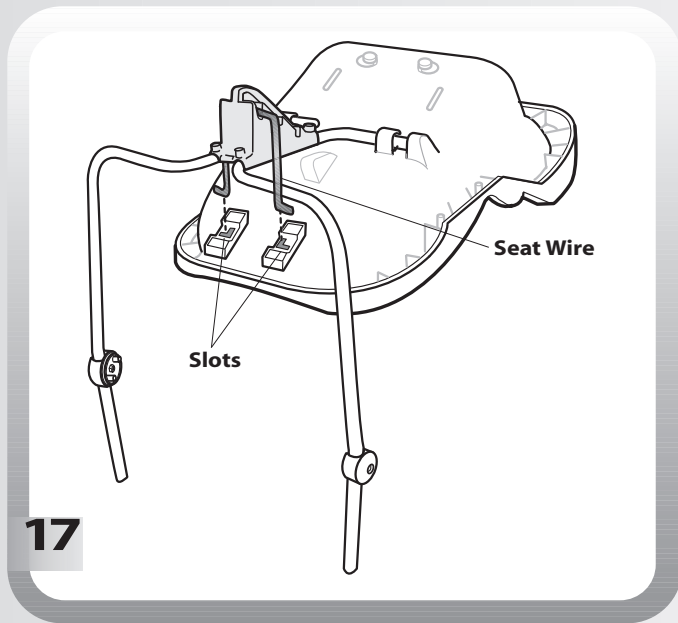

17

- Lift the seat tubes slightly.
- With the seat wire hanging down, insert the ends of the seat wire through the slots in the seat, as shown.

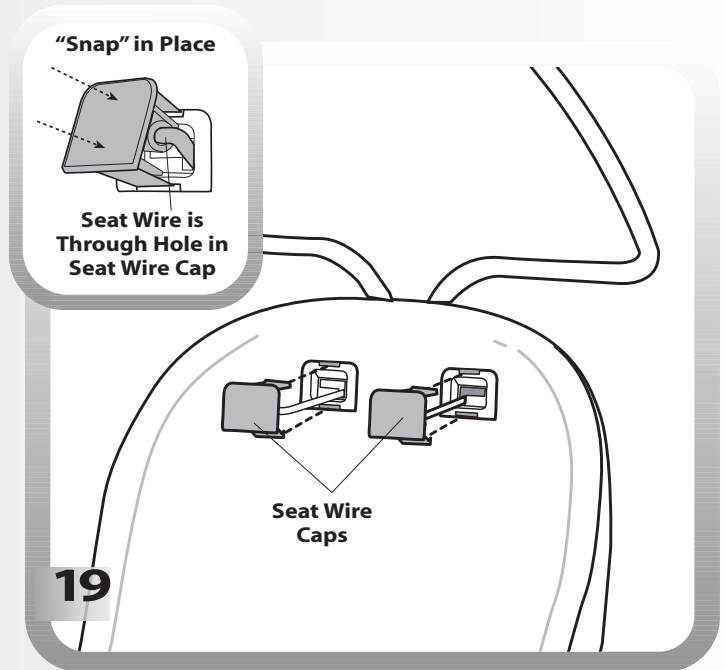

19

- Press to **“snap”** the seat wire caps into place.

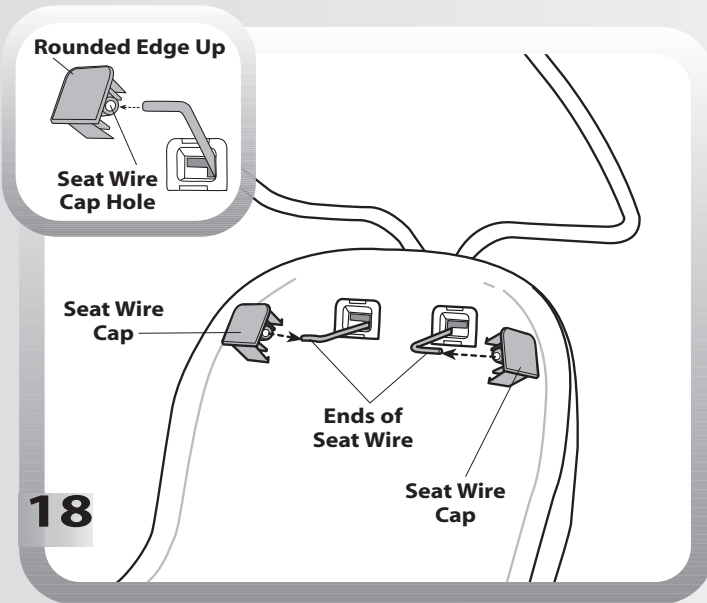

18

- While holding the seat wire in place, carefully turn the seat around so that the front of the seat faces you.
- Position the seat wire cap so that the rounded edge is upright.
- Fit each end of the seat wire through the hole in each seat wire cap.

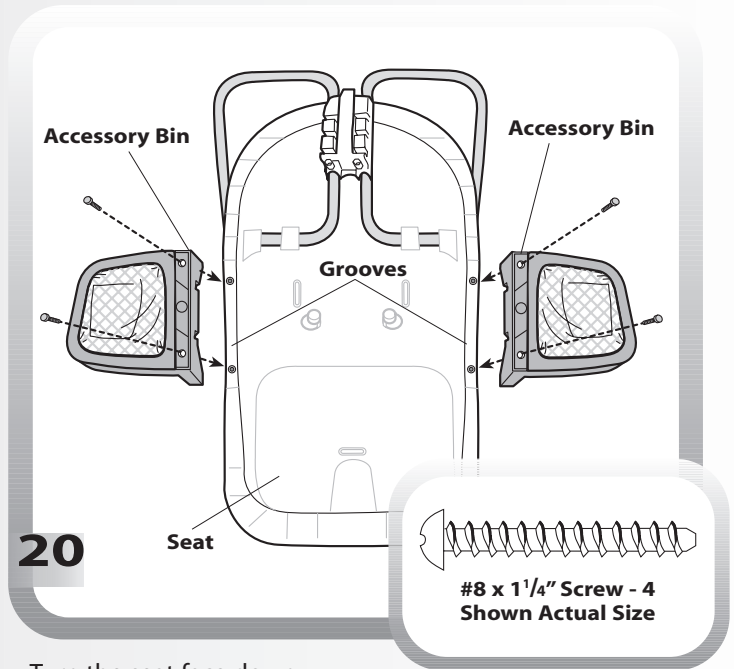

20

- Turn the seat face down.
- Fit an accessory bin into the groove on each side of the seat, as shown.
- Insert two #8 x 1/4" screws through each accessory bin and into the seat. Tighten the screws with a Phillips screwdriver. Do not over-tighten.

Assembly

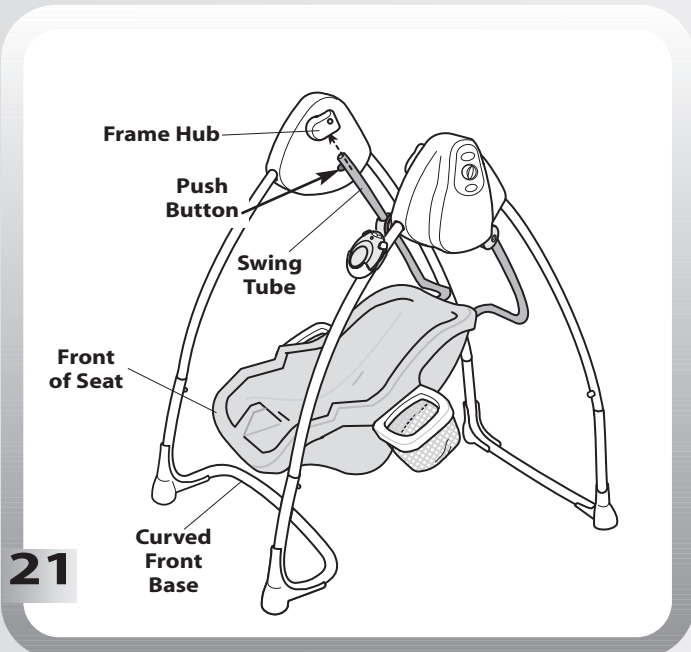

- Position the seat assembly so that the front of the seat is toward the curved front base.
- While pressing the buttons on the swing tubes, insert them into the frame hubs. Push the swing tubes up until the buttons “snap” into the hole in the frame hubs.
- Push down on the seat to be sure the seat is secured in both frame hubs.

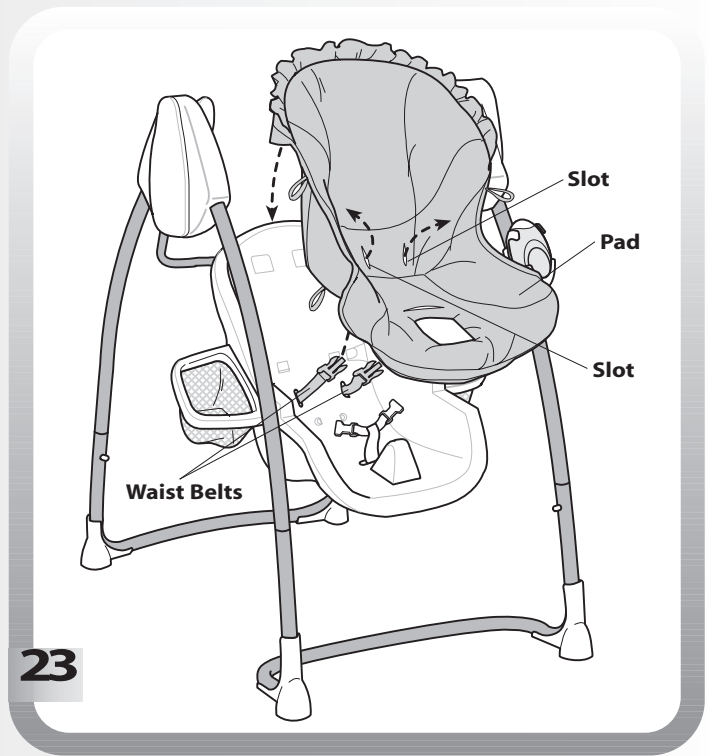

- Fit the pocket on the back of the pad onto the seat back.
- Fit the waist belts through the smaller slots in the pad.

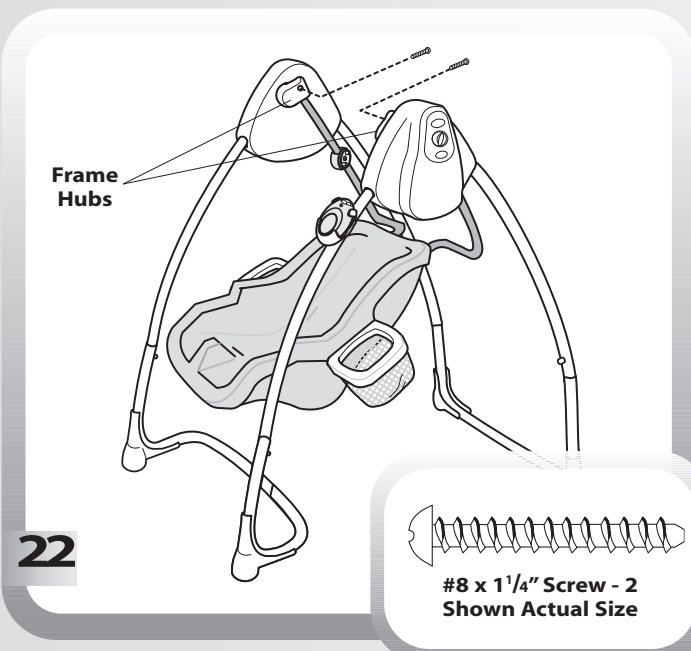

- Insert a #8 x 1 1/4" screw through each frame hub and into the swing tubes. Tighten the screws with a Phillips screwdriver. Do not over-tighten.
- Again, push down on the seat to be sure the seat is secured to both frame hubs.

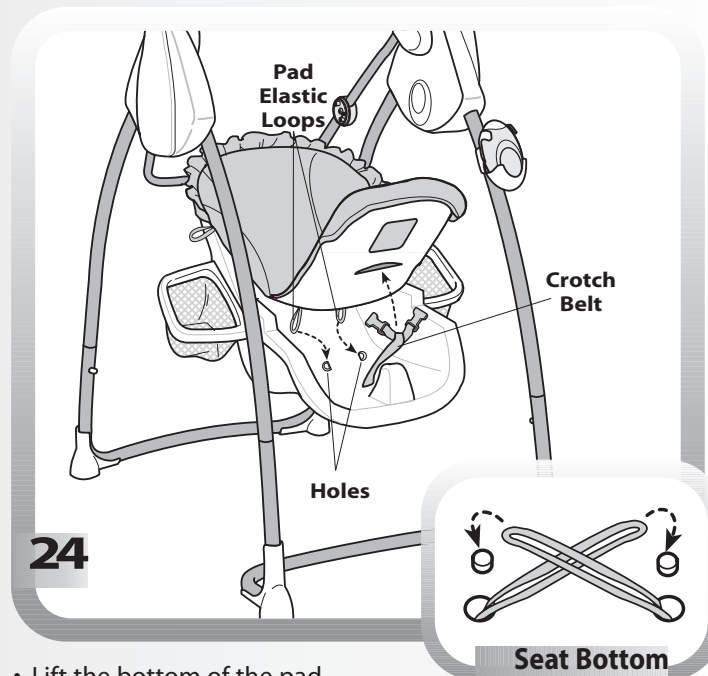

- Lift the bottom of the pad.
- Insert the pad elastic loops through the holes in the seat bottom.
- Insert the crotch belt through the slot in the pad.
- From under the seat, fit the elastic loops onto the tabs on the seat bottom.

Assembly

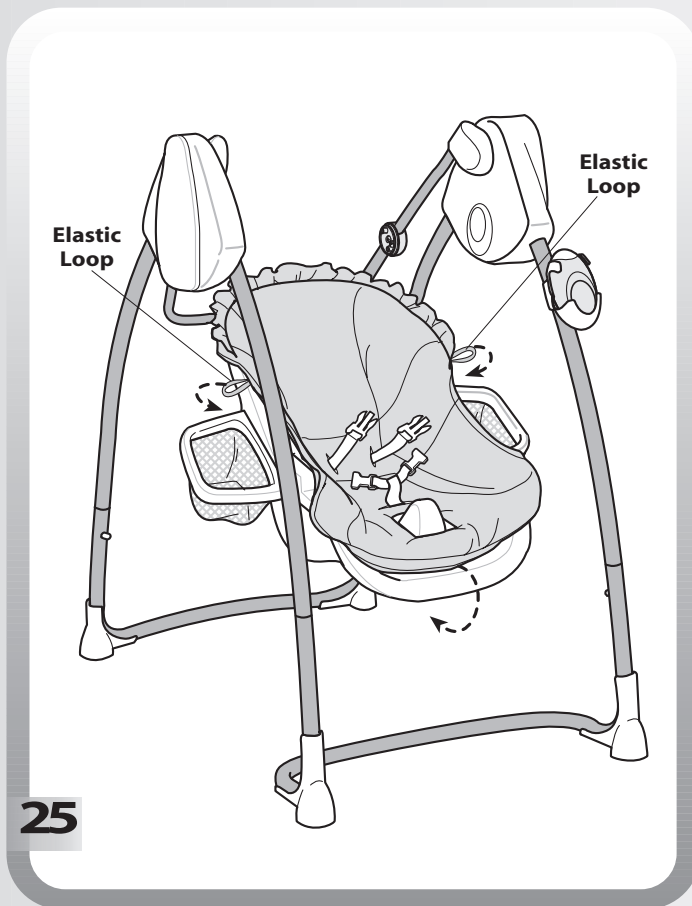

25

- Fit the bottom edge of the pad around the bottom edge of the seat.
- Hook the elastic loops on each side of the pad to the peg on the back of the accessory bins.

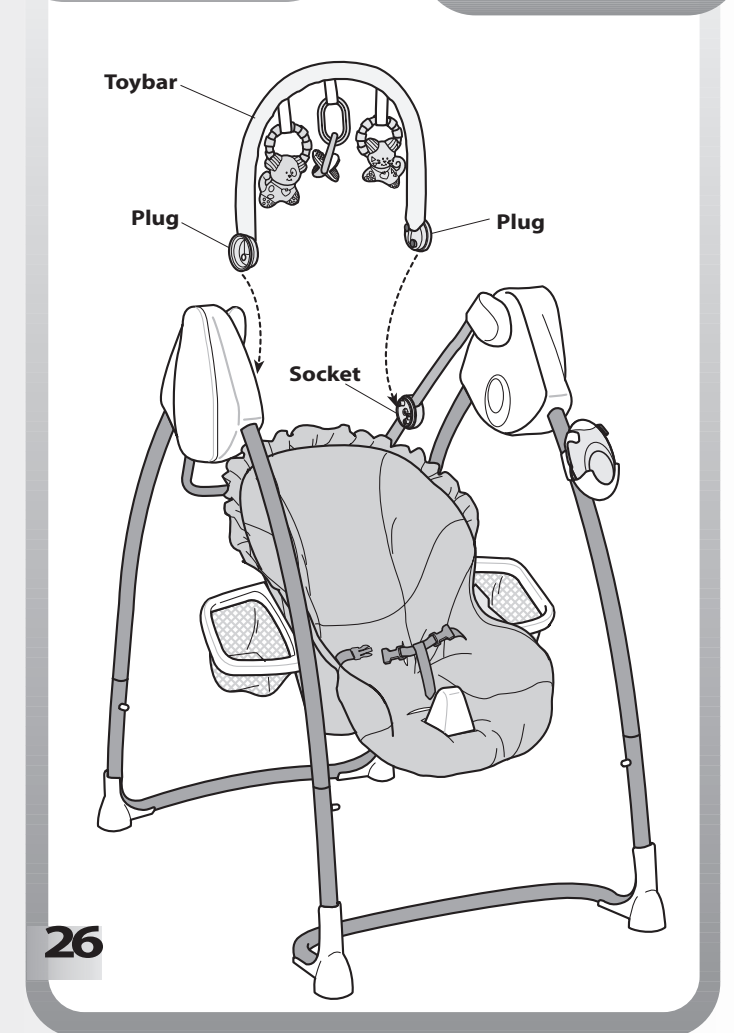
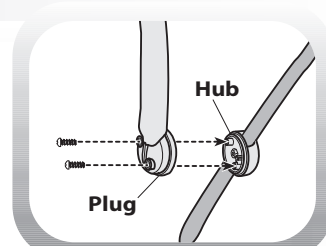
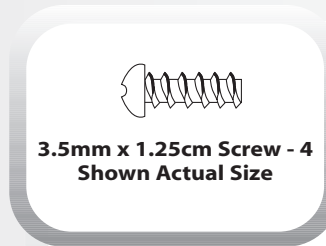

26

- Fit the toy bar plugs into the sockets on the swing tubes.
Hint: If the toybar plugs do not fit into the sockets, turn the toybar around. Now, fit the plugs into the sockets.
- Insert two 3.5mm x 1.25cm screws through each plug and into each socket. Tighten the screws with a Phillips screwdriver. Do not overtighten.

Battery Installation

Battery Tips

Hint: We recommend using **alkaline** batteries for longer battery life.

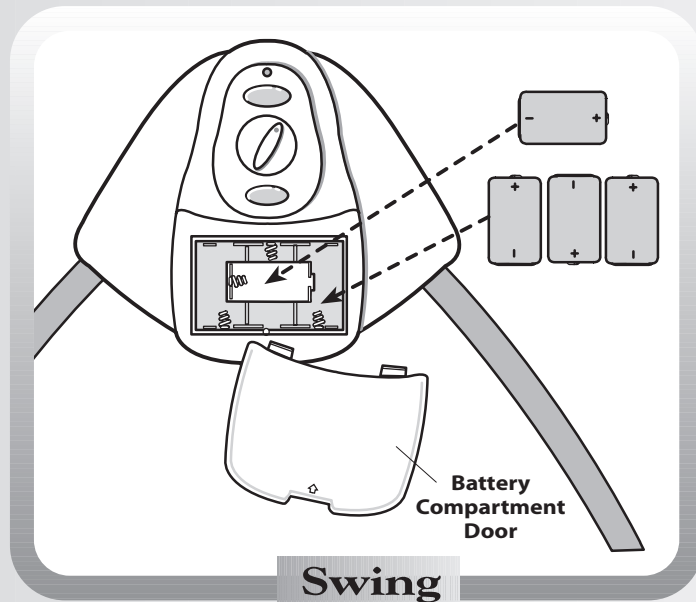

- Locate the battery compartment door on the swing frame.
- Insert a coin into the battery compartment door and pry the battery compartment door off of the swing frame.
- Insert four "D" (LR20) **alkaline** batteries as indicated inside the battery compartment.
- Replace the battery compartment door.

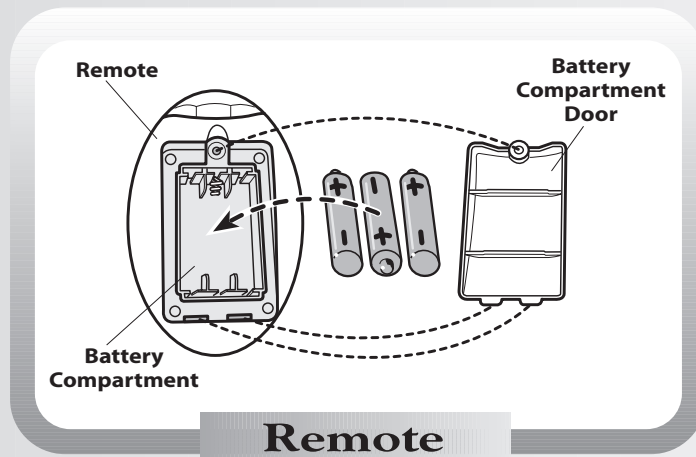

- Locate the battery compartment door on the back of the remote.
- Loosen the screw in the battery compartment door with a Phillips screwdriver. Lift to remove the battery compartment door.
- Insert three "AAA" (LR03) **alkaline** batteries as indicated inside the battery compartment.
- Replace the battery compartment door and tighten the screw with a Phillips screwdriver. Do not over-tighten.

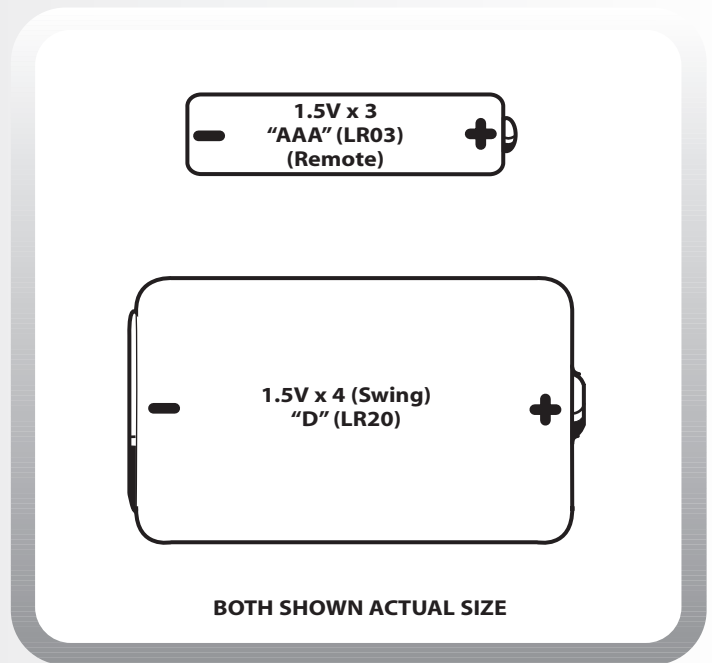

- When swinging, sounds or lights slows/dims/stops, it's time to change the batteries!
- Do not mix old and new batteries.
- Do not mix different types of batteries: alkaline, standard (carbon-zinc) or rechargeable (nickel-cadmium).
- Remove the batteries during long periods of non-use. Always remove exhausted batteries from the toy. Battery leakage and corrosion can damage this toy. Dispose of batteries safely.
- Do not dispose of batteries in a fire. The batteries may explode or leak.
- Never short circuit the battery terminals.
- Non-rechargeable batteries are not to be recharged.
- Only batteries of the same or equivalent type as recommended in the "Battery Installation" instructions are to be used.
- If removable rechargeable batteries are used, they are only to be charged under adult supervision.
- Rechargeable batteries are to be removed from the toy before they are charged.
- If you use a battery charger, it should be examined regularly for damage to the cord, plug, enclosure and other parts. Do not use a damaged battery charger until it has been properly repaired.

Securing Your Child

IMPORTANT! Before each use, inspect this product for damaged hardware, loose joints, missing parts or sharp edges. DO NOT use if any parts are missing or broken. Contact Fisher-Price® for replacement parts and instructions if needed. Never substitute parts.

WARNING

- To prevent falls, never use with an active child who may be able to climb out of the seat.
- Never leave child unattended.
- To prevent injury or death from falls or sliding out, always use restraint system. Never rely on the tray to restrain child.

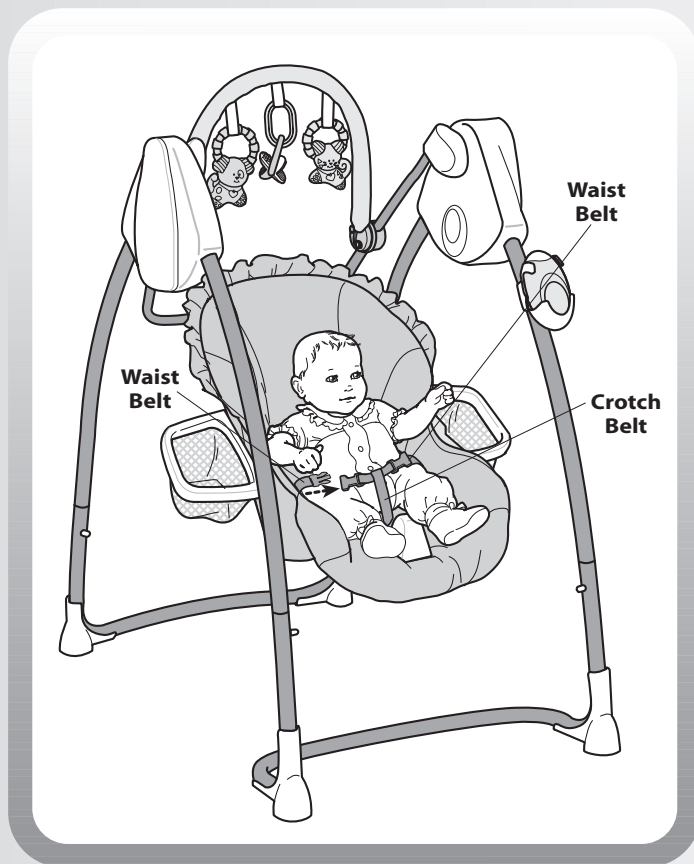

- Place your child in the seat. Position the crotch belt between your child's legs.
- Fasten both waist belts to each side of the crotch belt. Make sure you hear a **"click"** on both sides.
- Check to be sure the restraint system is securely attached by pulling it away from your child. The restraint system should remain attached.

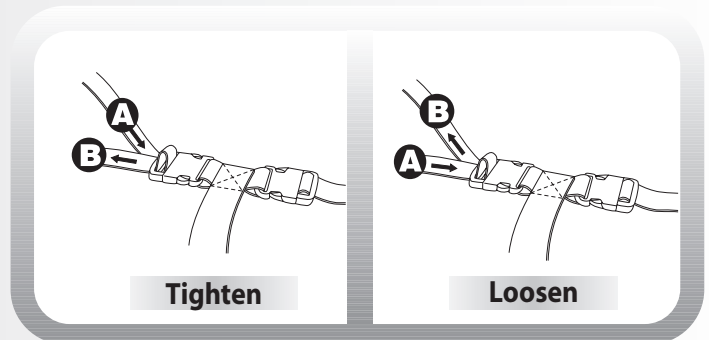

To tighten the restraint:

- Feed the anchored end of the waist belt up through the buckle to form a loop **A**.
- Pull the free end of the waist belt **B**.
- Repeat this procedure to tighten the other waist belt.

To loosen the restraint:

- Feed the free end of the waist belt up through the buckle to form a loop **A**.
- Enlarge the loop by pulling on the end of the loop toward the buckle.
- Pull the anchored end of the waist belt to shorten the free end of the waist belt **B**.
- Repeat this procedure to loosen the other restraint strap.

Note: After adjusting the restraint to fit your child, make sure you pull on it to be sure it is securely fastened.

Adjusting the Seat

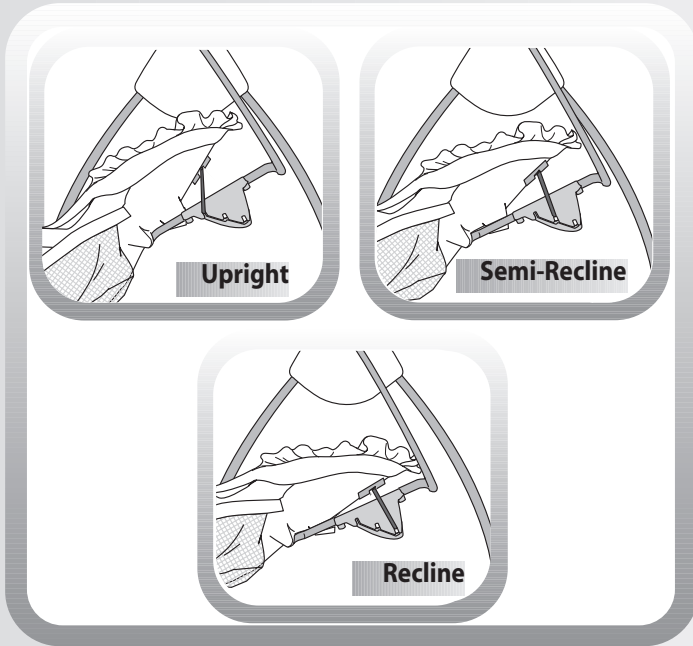

Adjust the seat angle in any of three positions:
Upright, Semi-Recline or Recline.

To adjust the seat angle:

- Push down on the seat back to position the seat wire in the desired groove in the bracket for Upright, Semi-Recline or Recline.

Using the Toybar

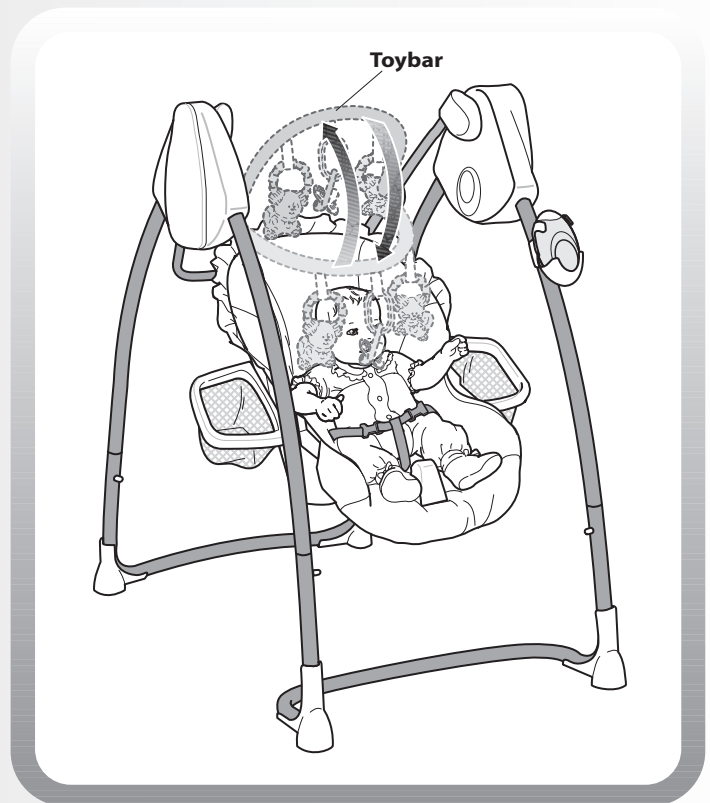

- Lift or lower the toybar for baby's enjoyment.

Tray



- Fit the tray onto the seat armrests.

Swinging

IMPORTANT! The maximum weight limit for this product is 24 lbs. If your child weighs less than 24 lbs., but is really active and appears to be able to climb out of the swing, immediately discontinue its use.

Hint: The swing will operate without use of the remote. Simply slide the power switch to on ●.



Dome

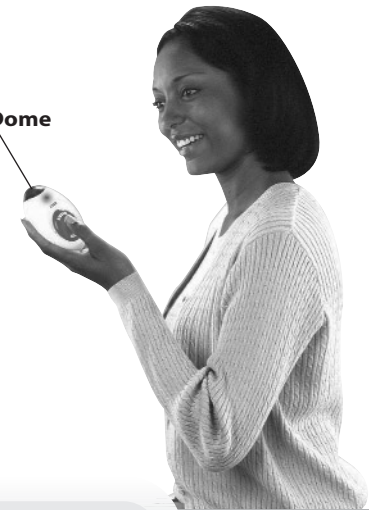

Hint: Make sure the dome on the remote and the dome on the swing are within 20 feet of each other, in a direct line and free of obstacles.

Power L.E.D.



- Slide the power switch to on ●. The power LED lights (and then blinks) and the swing begins swinging. If you do not use the remote, this swing continues swinging until the power switch is turned off ○. When using with the remote, press the top of the button once to turn swinging off. Press the top of the button again to turn swinging back on.

Hint: The swing will swing up to eight hours after the top of button on the remote is pushed. After eight hours, you will need to slide the power switch off ○ and then back on again ●.

- When the swing is not in use, slide the power switch to off ○.



- Turn the speed dial to select any of five settings.

Hint: As with most battery-powered swings, a heavier child reduces the amount of swinging motion on all settings. In most cases, the low setting works best for a smaller child while the high setting works best for a larger child.

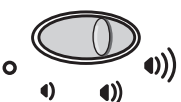

- If you'd like music along with swinging, slide the switch to))) for music highest volume;)) for music high volume or) for music low volume. When using with the remote, press the bottom of the button once to turn music off. Press the bottom of the button again to turn music back on.

- When the swing is not in use turn music off by sliding the switch to ○.

Hint: Music will be on for up to eight hours after the bottom of the button is pushed. After eight hours, you will need to slide the power switch off ○ and then back on ● again.

Storage

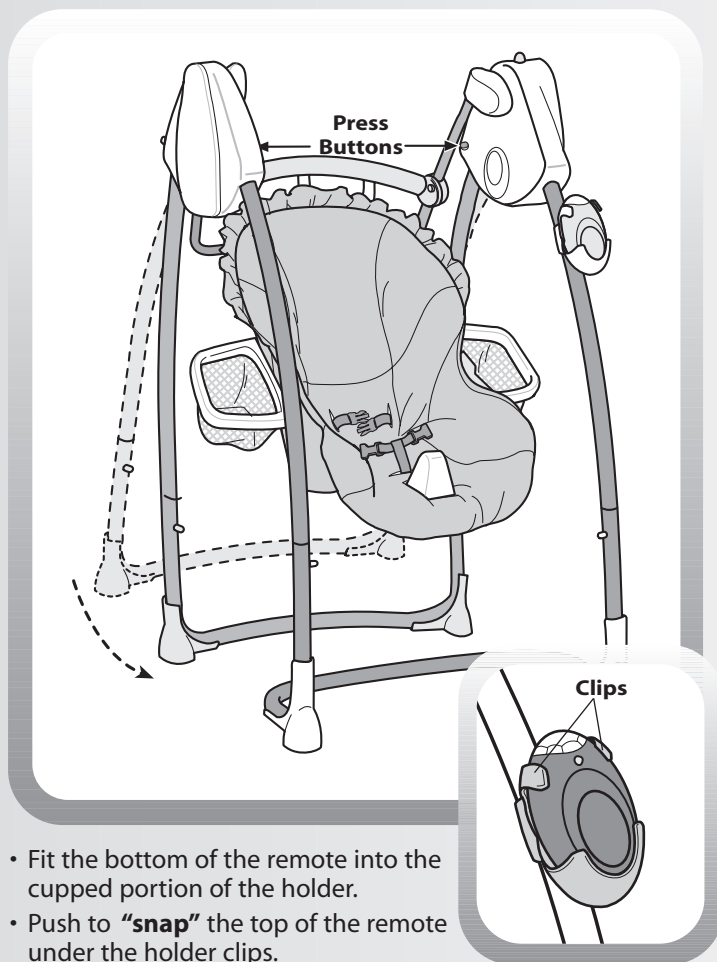

- Fit the bottom of the remote into the cupped portion of the holder.
- Push to “snap” the top of the remote under the holder clips.
- Turn the toybar back to its storage position.
- Press the button on the inside of each housing and push the rear legs toward the front legs. Stand the frame against a wall for storage.

Care

The pad is machine washable. Wash the pad separately in cold water on the gentle cycle. Do not use bleach. Tumble dry separately on low heat and remove promptly. The frame, tray and toybar may be wiped clean using a mild cleaning solution and a damp cloth.

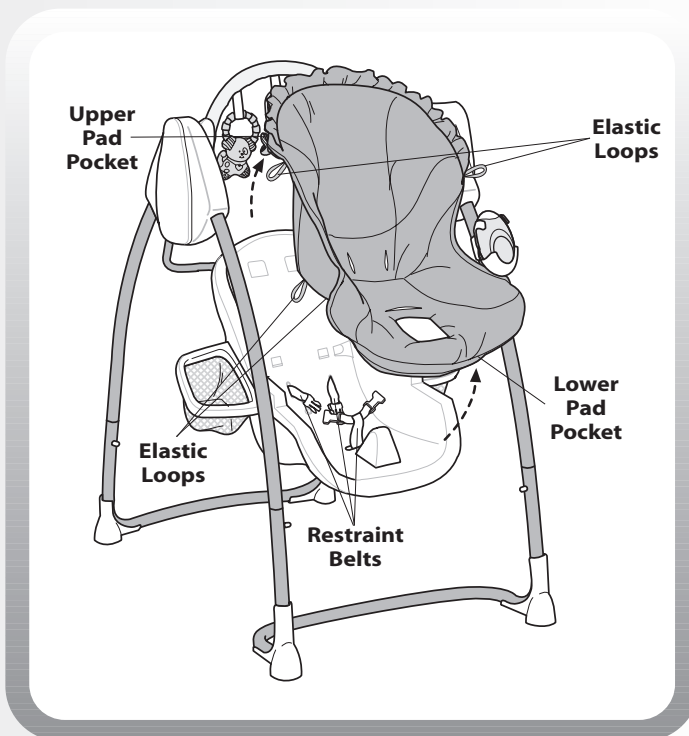

To remove the pad:

- Unhook the four elastic hooks from the pegs on the seat back and bottom.
- Push the restraint belts back through the slots in the pad.
- Slide the upper pad pocket off of the seat back.
- Slide the lower pad pocket off of the seat bottom.

To replace the pad:

- Refer to Assembly steps 19 - 21.

Note: This product has no consumer serviceable parts. Do not take this product apart.

For Best Results

- Make sure the remote is no further away than 20 feet from the swing.
- Make sure the remote and the swing are in a direct line and there are no obstacles between them.
- In the unlikely event that use of the remote interferes with normal use of other remote controlled equipment, such as televisions and stereos, or use of other electric or battery powered appliances interfere with operation of the swing, do not use both appliances at the same time.
- For best performance between the swing and the remote, avoid using the remote in areas of bright light. In bright natural or artificial light, you may notice loss of range. Move the swing or otherwise reduce the amount of light to improve performance.

One (1) Year Limited Warranty

Fisher-Price, Inc., 636 Girard Avenue, East Aurora, New York 14052 warrants that Quick Response Swing is free from all defects in material and workmanship when used under normal conditions for a period of one (1) year from the date of purchase.

Should the product fail to perform properly, we will repair or replace it at our option, free of charge. Purchaser is responsible for shipping the product to Consumer Relations at the address indicated above and for all associated freight and insurance cost. Fisher-Price, Inc. will bear the cost of shipping the repaired or replaced item to you. This warranty is void if the owner repairs or modifies the product. This warranty excludes any liability other than that expressly stated above including but not limited to any incidental or consequential damages.

SOME STATES DO NOT ALLOW THE EXCLUSION OR LIMITATION OF INCIDENTAL OR CONSEQUENTIAL DAMAGES, SO THE ABOVE LIMITATION OR EXCLUSION MAY NOT APPLY TO YOU.

THIS WARRANTY GIVES YOU SPECIFIC LEGAL RIGHTS, AND YOU MAY ALSO HAVE OTHER RIGHTS WHICH MAY VARY FROM STATE TO STATE.

FCC Statement (United States Only)

This equipment has been tested and found to comply with the limits for a Class B digital device, pursuant to part 15 of the FCC rules. These limits are designed to provide reasonable protection against harmful interference in a residential installation. This equipment generates, uses and can radiate radio frequency energy and, if not installed and used in accordance with the instructions, may cause harmful interference to radio communications. However, there is no guarantee that interference will not occur in a particular installation. If this equipment does cause harmful interference to radio or television reception, which can be determined by turning the equipment off and on, the user is encouraged to try to correct the interference by one or more of the following measures:

Reorient or relocate the receiving antenna.

Increase the separation between the equipment and receiver.

Connect the equipment into an outlet on a circuit different from that to which the receiver is connected.

Consult the dealer or an experienced radio/TV technician for help.

Note: Changes or modifications not expressly approved by the manufacturer responsible for compliance could void the user's authority to operate the equipment.

For other countries, outside the United States:

Canada: call **1-800-567-7724**, or write to: Mattel Canada Inc., 6155 Freemont Blvd., Mississauga, Ontario L5R 3W2.

Great Britain: telephone **01628 500302**.

Australia: Mattel Australia Pty. Ltd., 658 Church Street, Locked Bag #870, Richmond, Victoria 3121 Australia. Consumer Advisory Service 1300 135 312.

New Zealand: 16-18 William Pickering Drive, Albany 1331, Auckland.