

JVC



MICRO COMPONENT SYSTEM

SISTEMAS DE MICROCOMPONENTES

SISTEMA DE MICRO COMPONENTES

UX-M5

Consists of CA-UXM5 and SP-UXM5.
Se compone de CA-UXM5 y SP-UXM5.
Composto por CA-UXM5 e SP-UXM5

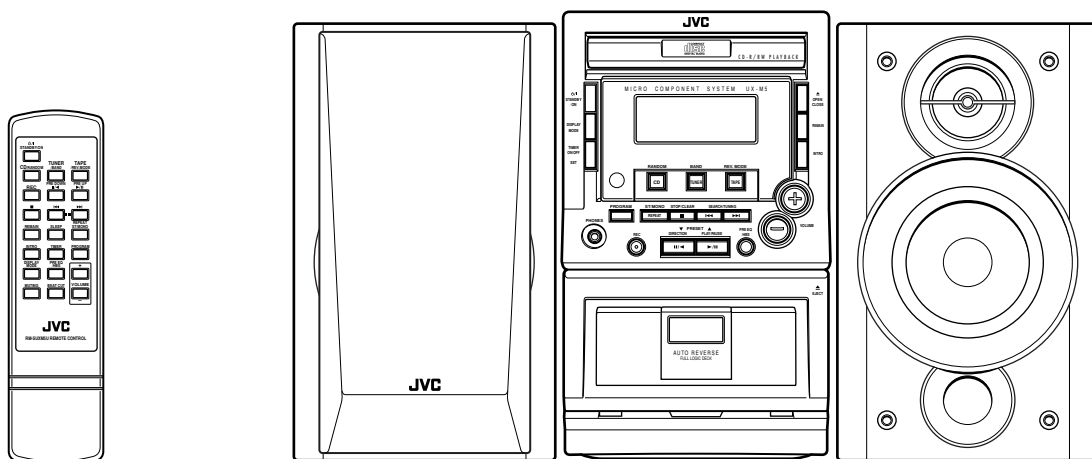

COMPACT
disc
DIGITAL AUDIO

INSTRUCTIONS

MANUAL DE INSTRUCCIONES
INSTRUÇÕES

For Customer Use:
Enter below the Model No. and Serial No.
which are located either on the rear, bottom
or side of the cabinet. Retain this information
for future reference.

Model No. _____

Serial No. _____

LVT0862-008A
[UW]

Warnings, Cautions and Others

Avisos, precauciones y otras notas

Advertências, precauções e outras notas

Caution — STANDBY/ON button!

Disconnect the mains plug to shut the power off completely. The  STANDBY/ON button in any position does not disconnect the mains line. The power can be remote controlled.

Precaución — Interruptor STANDBY/ON!

Desconectar el cable de alimentación para desactivar la alimentación totalmente. Cualquier que sea la posición de ajuste del interruptor  STANDBY/ON, la alimentación no es cortada completamente. La alimentación puede ser controlada remotamente.

Precaução — Interruptor STANDBY/ON!

Desconectar o cabo de alimentação para desligar a alimentação por completo. Qualquer que seja a posição de ajuste do interruptor  STANDBY/ON, a alimentação não é completamente cortada. A alimentação pode ser controlada remotamente.

CAUTION

To reduce the risk of electrical shocks, fire, etc.:

1. Do not remove screws, covers or cabinet.
2. Do not expose this appliance to rain or moisture.

PRECAUCIÓN

Para reducir riesgos de choques eléctricos, incendio, etc.:

1. No extraiga los tornillos, las cubiertas ni la caja.
2. No exponga este aparato a la lluvia o a la humedad.

PRECAUÇÃO

Para reduzir riscos de choques elétricos, incêndio, etc.:

1. Não remova parafusos e tampas ou desmonte a caixa.
2. Não exponha este aparelho à chuva nem à umidade.

CAUTION

- Do not block the ventilation openings or holes. (If the ventilation openings or holes are blocked by a newspaper or cloth, etc., the heat may not be able to get out.)
- Do not place any naked flame sources, such as lighted candles, on the apparatus.
- When discarding batteries, environmental problems must be considered and local rules or laws governing the disposal of these batteries must be followed strictly.
- Do not expose this apparatus to rain, moisture, dripping or splashing and that no objects filled with liquids, such as vases, shall be placed on the apparatus.

PRECAUCIÓN

- No obstruya las rendijas o los orificios de ventilación. (Si las rendijas o los orificios de ventilación quedan tapados con un periódico, un trozo de tela, etc., no se podrá disipar el calor).
- No ponga sobre el aparato ninguna llama al descubierto, como velas encendidas.
- Cuando tenga que descartar las pilas, tenga en cuenta los problemas ambientales y observe estrictamente los reglamentos o las leyes locales sobre disposición de las pilas.
- No exponga este aparato a la lluvia, humedad, goteos o salpicaduras. Tampoco ponga recipientes conteniendo líquidos, como floreros, encima del aparato.

PRECAUÇÃO

- Não obstrua as aberturas e orifícios de ventilação. (Se os orifícios ou aberturas de ventilação estiverem obstruídos por qualquer papel ou tecido, não haverá circulação do ar quente.)
- Não coloque nenhum objeto com chamas, como velas acesas, sobre o aparelho.
- Ao descartar as baterias, leve em consideração os problemas que possam ser causados ao meio ambiente e os regulamentos e leis locais e governamentais sobre recolhimento dessas baterias devem ser rigorosamente seguidos.
- Não exponha este aparelho à chuva, umidade, pingos ou esguichos de água, nem coloque em cima do mesmo qualquer tipo de recipiente que contenha líquidos, como por exemplo vasos.

**IMPORTANT FOR LASER PRODUCTS / IMPORTANTE PARA PRODUCTOS LÁSER /
IMPOTANTE PARA PRODUTOS LASER**

REPRODUCTION OF LABELS / REPRODUCCIÓN DE ETIQUETAS / REPRODUÇÃO DE ETIQUETAS

- ① CLASSIFICATION LABEL, PLACED ON EXTERIOR SURFACE
- ① ETIQUETA DE CLASIFICACIÓN, PROVISTA SOBRE LA SUPERFICIE EXTERIOR
- ① ETIQUETA DE CLASSIFICAÇÃO LOCALIZADA NA PARTE POSTERIOR DA CAIXA DO APARELHO

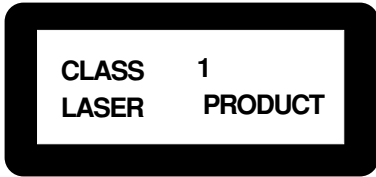

- ② WARNING LABEL, PLACED INSIDE THE UNIT
- ② ETIQUETA DE ADVERTENCIA, PEGADA EN EL INTERIOR DE LA UNIDAD
- ② ETIQUETA DE ADVERTÊNCIA LOCALIZADA NA PARTE INTERNA DA UNIDADE

<p>DANGER-Invisible laser radiation when open and interlock defeated. AVOID DIRECT EXPOSURE TO BEAM.</p>	<p>VARO! Avattaessa ja suojalukitus ohitettaessa olet alttiina nädkmätön läsersateilylle. Älä katso säteeseen.</p>
<p>VORSICHT-Unsichtbare Laserstrahlung, wenn Abdeckung geöffnet und Sicherheitsverriegelung überbrückt. Nicht dem Strahl aussetzen.</p>	<p>WARNING! Osymilg laserstrålning när denna del är ösppad och spårren är urkopplad. Beträka ej strålen.</p>
<p>ADVARSEL-USYNLIG LÅSERSTRÅLING VED ÅBNING. NÅR SIKKERHEDSAFBRYDERE ER UDE AF FUNKTION. UNDGÅ UDSÆTTELSE FOR STRÅLING.</p>	<p>ADVERSEL! Usynlig laserstråling når deksel åpnes og slikkerhedslås brytes. Unngå eksponering for strålen. A pleine puissance. L'ecoute prolongee du baladeur peut endommager l'oreille de l'utilisateur.</p>

- 1. CLASS 1 LASER PRODUCT
- 2. **CAUTION:** Invisible laser radiation when open and interlock failed or defeated. Avoid direct exposure to beam.
- 3. **CAUTION:** Do not open the top cover. There are no user serviceable parts inside the Unit; leave all servicing to qualified service personnel.

- 1. PRODUCTO LÁSER CLASE 1
- 2. **PRECAUCIÓN:** En el interior hay radiación láser invisible. Evite el contacto directo con el haz.
- 3. **PRECAUCIÓN:** No abra la tapa superior. En el interior de la unidad no existen piezas reparables por el usuario; deje todo servicio técnico en manos de personal calificado.

- 1. PRODUTO LASER CLASSE 1
- 2. **CUIDADO:** O laser emite uma radiação invisível que é perigosa, caso o aparelho esteja aberto e a trava inoperante ou danificada. Evite exposição direta ao feixe dos raios.
- 3. **CUIDADO:** Não abra a caixa do aparelho. Não existem peças reparáveis pelo usuário na parte interna da unidade. Solicite assistência técnica somente a pessoal técnico qualificado.

CAUTION: Proper Ventilation

To avoid risk of electric shock and fire, and to prevent damage, locate the apparatus as follows:

- 1 Front: No obstructions and open spacing.
- 2 Sides/ Top/ Back: No obstructions should be placed in the areas shown by the dimensions below.
- 3 Bottom: Place on the level surface. Maintain an adequate air path for ventilation by placing on a stand with a height of 10 cm or more.

Precaución: el aparato debe estar bien ventilado

Para evitar posibles riesgos de descargas eléctricas e incendios y prevenir cualquier posible daño, coloque el aparato del modo siguiente:

- 1 Parte delantera: No ponga nada delante, deje el espacio libre.
- 2 Laterales/ parte superior/ parte trasera: No se debería colocar nada en las áreas y las distancias que se detallan a continuación.
- 3 Parte inferior: Coloque el aparato sobre una superficie recta. Debe haber buena circulación de aire; para ello, coloque el aparato sobre una base a una altura mínima de 10 cm.

Precaução: Ventilação adequada

Para evitar riscos de choques elétricos e incêndios, e prevenir avarias, instale o aparelho como segue:

- 1 Parte frontal: Sem obstruções e espaços abertos.
- 2 Partes laterais/ Tampa/ Posterior: Nenhuma obstrução deverá ser colocada entre as áreas cujas dimensões são indicadas abaixo.
- 3 Parte inferior: Instale-o sobre uma superfície plana. Deverá ser mantido espaço suficiente para a ventilação se este for instalado numa posição que tenha uma altura de 10 cm ou mais.

**Front view
Vista frontal
Vista frontal**

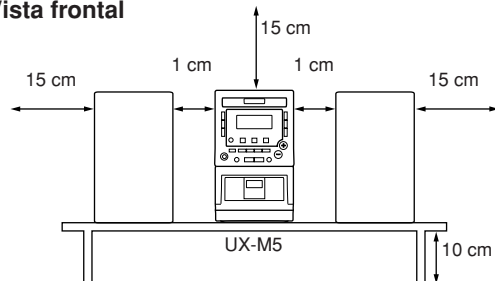

**Side view
Vista lateral
Vista lateral**

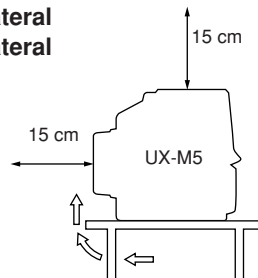

Introduction

We would like to thank you for purchasing one of our JVC products. Before operating this unit, read this manual carefully and thoroughly to obtain the best possible performance from your unit, and retain this manual for future reference.

About This Manual

This manual is organized as follows:

- The manual mainly explains operations using the buttons and controls on the unit. You can also use the buttons on the remote control if they have the same or similar names (or marks) as those on the unit. If operation using the remote control is different from that using the unit, it is then explained.
- Basic and common information that is the same for many functions is grouped in one place, and is not repeated in each procedure. For instance, we do not repeat the information about turning on/off the unit, setting the volume, changing the sound effects, and others, which are explained in the section “Common Operations” on pages 8 and 9.
- The following marks are used in this manual:



Gives you warnings and cautions to prevent a damage or risk of fire/electric shock. Also gives you information on operation which is not good for obtaining the best possible performance from the unit.



Gives you information and hints you had better know.

Precautions

Installation

- Install in a place which is level, dry and neither too hot nor too cold — between 5°C and 35°C.
- Install the unit in a location with adequate ventilation to prevent internal heat built-up in the unit.
- Leave sufficient distance between the unit and the TV.
- Keep the speakers away from the TV to avoid interference with TV.



DO NOT install the unit in a location near heat sources, or in a place subject to direct sunlight, excessive dust or vibration.

Power sources

- When unplugging from the wall outlet, always pull the plug, not the AC power cord.



DO NOT handle the AC power cord with wet hands.

Moisture condensation

Moisture may condense on the lens inside the unit in the following cases:

- After starting heating in the room
 - In a damp room
 - If the unit is brought directly from a cold to a warm place
- Should this occur, the unit may malfunction. In this case, leave the unit turned on for a few hours until the moisture evaporates, unplug the AC power cord, and then plug it in again.

Others

- Should any metallic object or liquid fall into the unit, unplug the unit and consult your dealer before operating any further.
- If you are not going to operate the unit for an extended period of time, unplug the AC power cord from the wall outlet.



DO NOT disassemble the unit since there are no user serviceable parts inside.

If anything goes wrong, unplug the AC power cord and consult your dealer.

Location of the Buttons and Controls	3
Front Panel	4
Remote Control	5
Getting Started	6
Unpacking	6
Putting the Batteries into the Remote Control	6
Connections	6
Common Operations	8
Turning On or Off the Unit	8
Setting the Clock	8
Adjusting the Volume	8
Digital Sound Control	9
Listening to FM and AM Broadcasts	10
Tuning In a Station	10
Presetting Stations	10
Tuning In a Preset Station	10
Playing Back CDs	11
Loading a Disc	11
Basic CD Operations	11
Program Play	11
Random Play	12
Repeat Play	12
Introductory Play	12
Displaying the Remaining Time during Playback ..	12
Playing Back Tapes	13
Loading a Tape	13
Tape Playback	13
Auto Reverse	13
Rewind/Fast Forward	13
Recording	14
Recording Tapes	14
Using the Timers.....	15
Using Daily Timer	15
Timer Recording	15
Using Sleep Timer	16
Troubleshooting	17
Maintenance	18
Specifications	19

Location of the Buttons and Controls



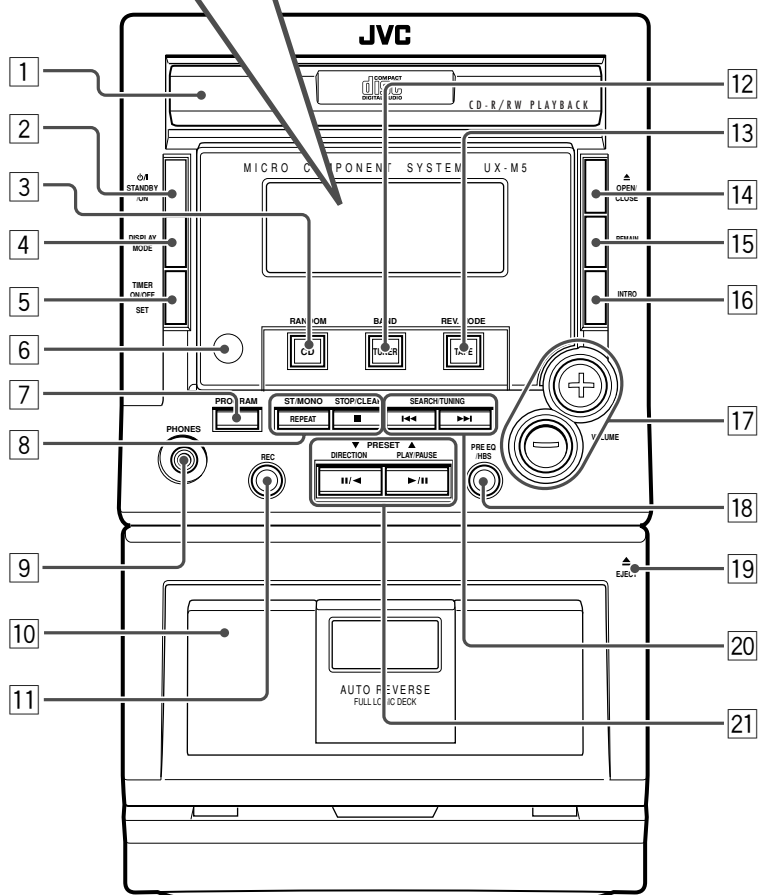
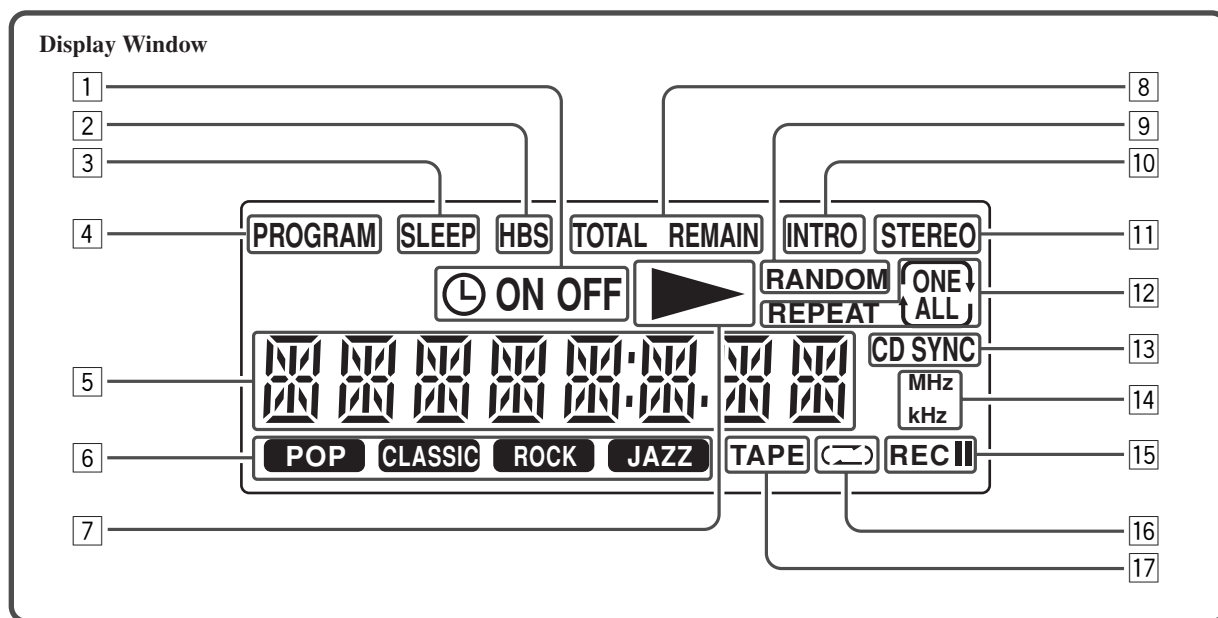

Become familiar with the buttons and controls on your unit.





Front Panel







Front Panel

See pages in the parentheses for details.

- 1 Disc compartment (11)
- 2  STANDBY/ON button (8)
Turns the unit on or off (standby mode).
- 3 CD/RANDOM button (11, 12)
*Selects CD mode.
Starts or stops random play in CD mode.*
- 4 DISPLAY MODE button (8, 15)
Displays the clock time or sets the timer.
- 5 TIMER ON/OFF SET button (15)
Activates/deactivates the timer.
- 6 Remote sensor (5)
Infrared sensor for remote control
- 7 PROGRAM button (8, 10, 11, 15)
*CD: programs the track playback order.
Tuner: presets radio stations.
Clock/Timer: sets the clock/timer.*
- 8 REPEAT button (12)
*CD: repeats a track or the whole disc.
ST/MONO button (10)
Tuner: switches between stereo and monaural mode (on FM band only).*
- STOP/CLEAR  button (11, 13)
*CD: stops playback or clears the program.
Tape: stops playback or recording.*
- 9 PHONES jack (8)
Connect the headphones to this jack.
- 10 Tape deck (13)
- 11 REC  (Recording) button (14)
Switches to record ready state.
- 12 TUNER/BAND button (10)
*Selects tuner mode.
Selects FM or AM in tuner mode.*
- 13 TAPE/REV.MODE button (13)
*Selects tape mode.
Selects auto reverse mode.*
- 14  OPEN/CLOSE button (11)
Opens/closes the disc compartment.
- 15 REMAIN button (12)
CD: displays the remaining time of a track/disc or elapsed time of a disc during playback.
- 16 INTRO button (12)
CD: starts or stops introductory play.
- 17 VOLUME +/- buttons (8)
Adjust the volume.
- 18 PRE EQ/HBS button (9)
*Selects the desired sound mode.
Switches on or off the HBS system.*
- 19  EJECT (13)
Opens the tape deck door.

- 20 SEARCH/TUNING  buttons (8, 10, 11, 13, 15)
*CD: search backward/forward or skip to the beginning of the current/previous/next track.
Tuner: tune to a lower or higher radio frequency or search radio stations.
Tape: rewind or fast forward.
Clock/Timer: set the hour and minute.*
- 21 DIRECTION  and  buttons (13)
*Tape: start playback or recording in the selected direction.
PLAY/PAUSE  button (11, 13)
CD/Tape: starts or interrupts playback.
PRESET  buttons (10)
Tuner: Selects a preset radio station.*

Display window

- 1  /ON/OFF (timer on/off) indicators (15)
- 2 HBS indicator (9)
- 3 SLEEP indicator (16)
- 4 PROGRAM indicator (10, 11)
- 5 Main display
- 6 Sound mode indicators (9)
POP, CLASSIC, ROCK, JAZZ
- 7  (play mode) indicator (11, 13)
- 8 TOTAL/REMAIN indicators (12)
- 9 RANDOM indicator (12)
- 10 INTRO indicator (12)
- 11 STEREO indicator (10)
- 12 REPEAT ONE/ALL indicators (12)
- 13 CD SYNC (synchronous recording) indicator (14)
- 14 MHz/kHz (frequency) indicators (10)
- 15 REC/ (recording/pause) indicators (14)
- 16  (tape direction) indicator (13, 14)
- 17 TAPE indicator (13)

Remote Control

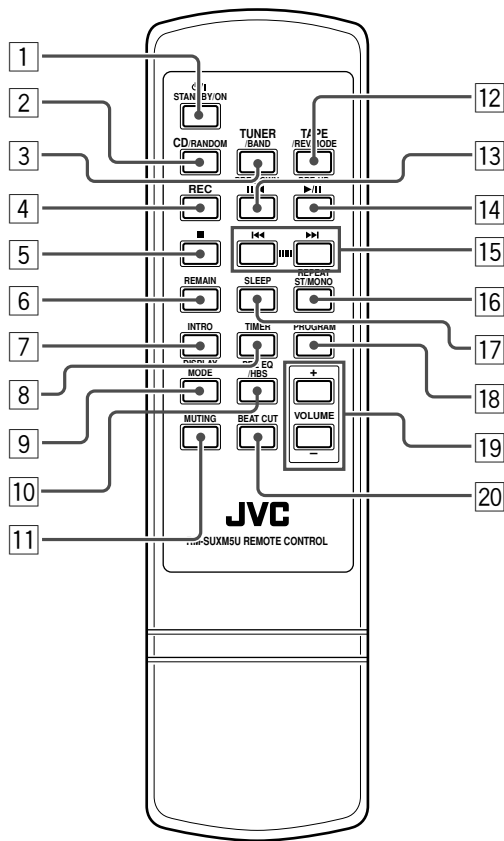

Remote Control

- 1 STANDBY/ON button
 - 2 CD/RANDOM button
 - 3 TUNER/BAND button
 - 4 REC (Recording) button
 - 5 ■ button
 - 6 REMAIN button
 - 7 INTRO button
 - 8 button
 - 9 button
 - 10 SLEEP button
 - 11 REPEAT ST/MONO button
 - 12 button
 - 13 button
 - 14 button
 - 15 button
 - 16 button
 - 17 button
 - 18 button
 - 19 VOLUME +/- buttons
 - 20 button
- Interrupts and resumes sound reproduction.*
- Selects the time length until the unit is turned off.*
- Eliminates beats during AM broadcast recording.*

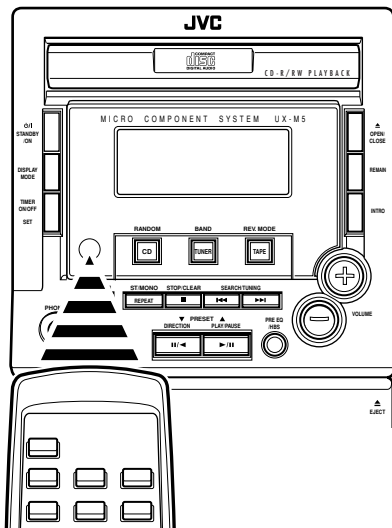

When using the remote control, point it at the remote sensor on the front panel.

Unpacking

After unpacking, check to be sure that you have all the following items.

The number in the parentheses following each item name indicates the supplied quantity.

- Remote control (1)
- Batteries R03 (UM-4)/AAA (24F) for remote control (2)
- AM loop antenna (1)
- AC plug adapter (1)

If any is missing, consult your dealer immediately.

Putting the Batteries into the Remote Control

Insert 2 batteries — R03 (UM-4)/AAA (24F) — into the battery compartment of the remote control, complying with the + and – polarity markings inside the battery compartment. When the remote control can no longer operate the unit, replace both batteries at the same time.

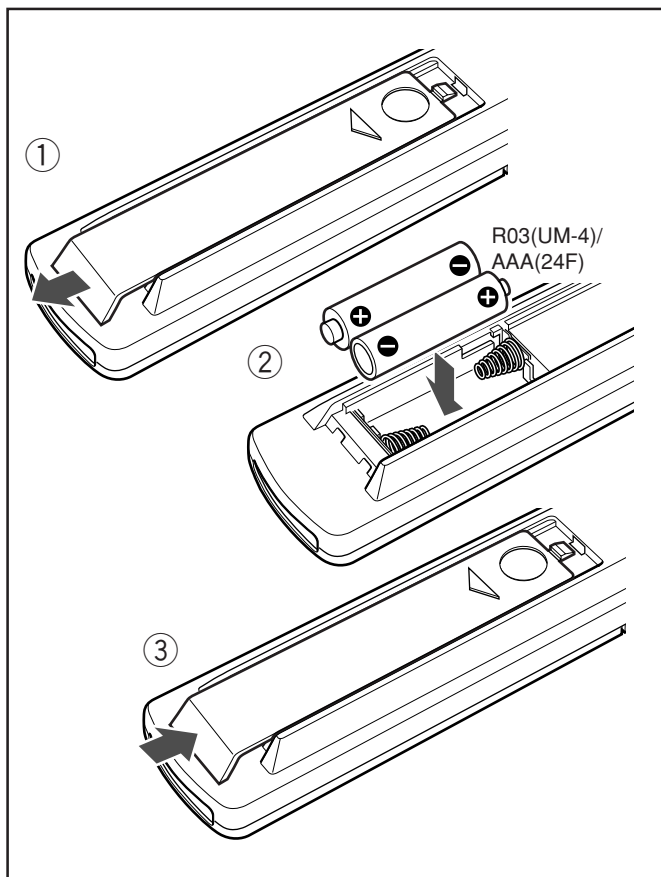

- DO NOT use an old battery together with a new one.
- DO NOT use different types of batteries together.
- DO NOT expose batteries to heat or flame.
- DO NOT leave the batteries in the battery compartment when you are not going to use the remote control for an extended period of time; otherwise, the remote control may be damaged by battery leakage.

Connections



- DO NOT connect any equipment to the unit while the unit is powered.
- DO NOT plug in any equipment until all connections are completed.

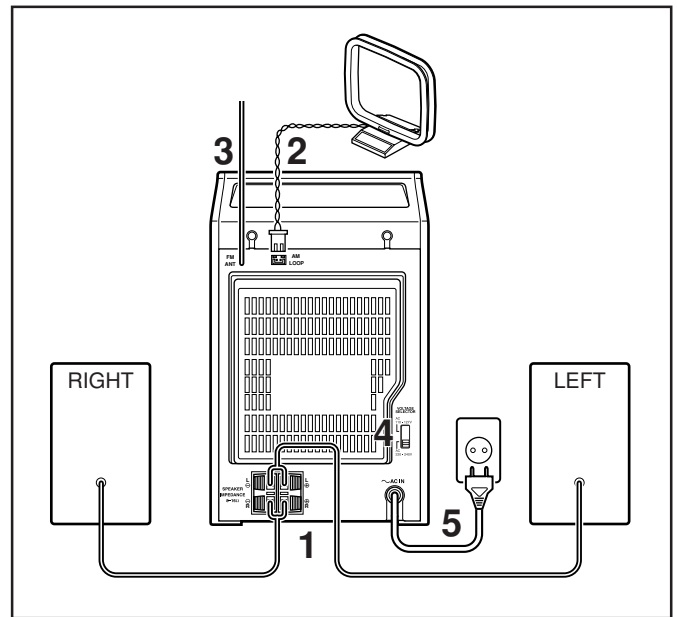

1 Connect the speakers.

Connect the right speaker to the “R” terminals, with the red wire to + and the black wire to –.

Connect the left speaker to the “L” terminals in the same way.

Clip the stripped portion of each speaker wire as shown in the illustration.

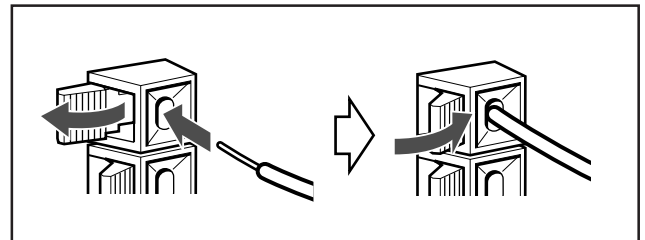

2 Connect the supplied AM loop antenna to the AM LOOP terminal.

Place the antenna away from the unit and adjust its position for the best reception.

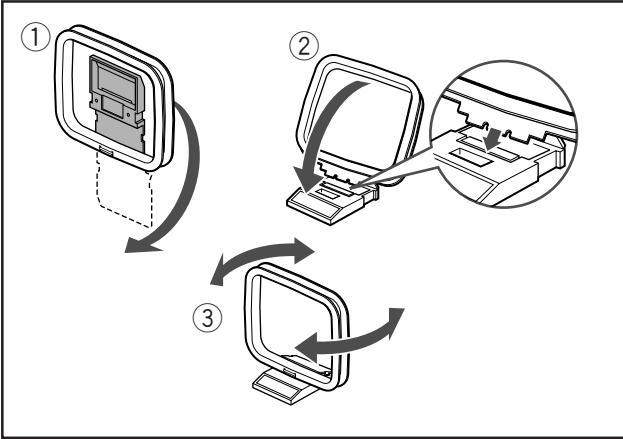

3 Adjust the position of the FM antenna for the best reception.

4 Set the voltage selector to the local power line voltage.

5 Connect the AC power cord of the unit to the AC outlet after all other connections have been made.

To remove the speaker grilles

The speaker grilles can be removed as shown in the illustration below.

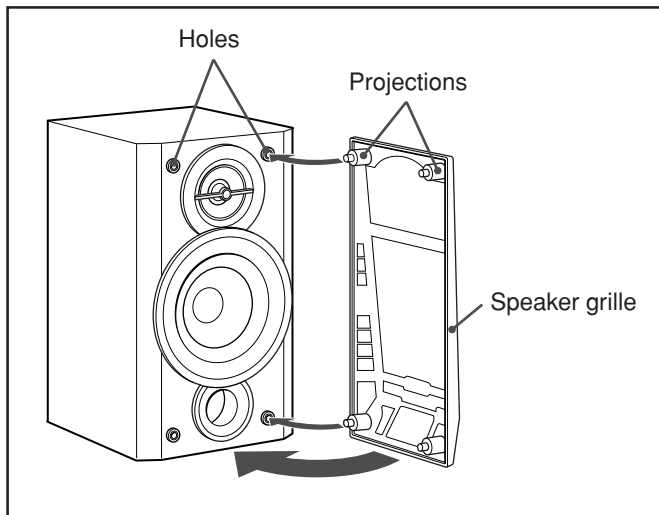

To remove the speaker grille, inserting your fingers at the top of the speaker grille, pull it towards you. Then pull the bottom towards you.

To attach the speaker grille, put the projections of the speaker grille into the holes of the speaker.

Turning On or Off the Unit

To turn on the unit

Press  STANDBY/ON on the unit or remote control.

The unit turns on with the last source selection remaining valid.

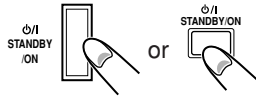

To turn off the unit (on standby)

Press  STANDBY/ON on the unit or remote control. The clock time appears if the clock is already set.

Setting the Clock

Before operating the unit any further, first set the built-in clock.

1 When the unit is in standby mode, press and hold PROGRAM until the hour indication starts blinking.



- When the unit is on, press DISPLAY MODE to enter clock mode, then press and hold PROGRAM.

2 Press or to set the hour, then press PROGRAM.

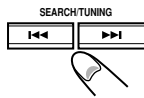

The minute indication starts blinking.

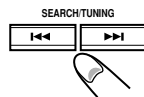

3 Press or to set the minute, then press PROGRAM to store the setting.

The clock starts working.



To change the hour or minute indication rapidly in steps 2 and 3, press and hold  or .

To select 12-hour or 24-hour display mode

In standby mode, hold down  and press PROGRAM on the unit repeatedly.

With each press, the selection toggles between 12-hour and 24-hour modes.

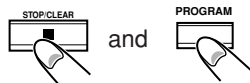

- In 12-hour mode, “AM 12:00” indicates midnight and “PM 12:00” indicates noon.

To check the clock time while the unit is on

Press DISPLAY MODE.

The clock time is displayed until you press any key.

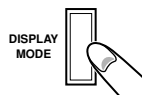

To correct the clock time

Carry out steps 1 to 3 above.



On clock resetting

If a power failure occurs or the AC power cord is disconnected, the clock is reset to “00:00” (flashing). In such a case you need to set the clock again.

Adjusting the Volume

- You can adjust the volume only while the unit is turned on.

Press VOLUME + or VOLUME – to increase or decrease the volume level.



The volume can be adjusted in 41 steps between “VOL MIN” (minimum) and “VOL MAX” (maximum).

To increase or decrease the volume level rapidly, press and hold VOLUME + or VOLUME –.

To turn off the sound temporarily

Press MUTING on the remote control. Playback continues without sound and “MUTING” appears on the display.



To restore the sound, press MUTING again or increase or decrease the volume level.



For private listening

Connect a pair of headphones to the PHONES jack. No sound comes out of the speakers. Be sure to turn down the volume before connecting or putting on headphones.



DO NOT turn off the unit (on standby) with the volume set to an extremely high level; otherwise, a sudden blast of sound can damage your hearing and/or the speakers when you turn on the unit or start playing any source next time.

Digital Sound Control

The unit's digital sound control feature enables you to select desired preset equalizer settings (selectable as sound modes) to enjoy special sound effects matching the music type. You can also use the HBS (Hyper Bass Sound) system to enjoy powerful bass sound created by emphasizing low frequencies.

To select the desired sound mode

Press PRE EQ/HBS repeatedly.



Each time you press the button, the sound mode changes as follows:

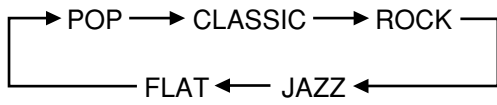

POP: More presence in the vocals and midrange

CLASSIC: Enriched sound with fine treble and ample bass

ROCK: Powerful sound emphasizing treble and bass

JAZZ: Accented lower frequencies for jazz-type music

FLAT: Equalizer effect is canceled.

To switch the HBS system on/off

Press and hold PRE EQ/HBS until "HBS ON" or "HBS OFF" appears on the display.



When the HBS system is switched on, the HBS indicator lights up on the display.

Listening to FM and AM Broadcasts

Tuning In a Station

- 1 **When the unit is turned on, press TUNER/BAND to select tuner mode.**

The unit tunes in the last station tuned in (either FM or AM).



- 2 **Press TUNER/BAND to select the band, FM or AM.**

Each time you press the button, the band selection alternates between FM and AM.

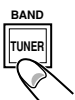

- 3 **Press and hold ◀◀ or ▶▶ for more than 1 second.**

The unit starts searching for stations and stops when a station of sufficient signal strength is tuned in.

If a program is broadcast in stereo, the STEREO indicator lights up.



To stop searching, press ◀◀ or ▶▶.



When you press ◀◀ or ▶▶ briefly and repeatedly the frequency changes step by step.

To improve the FM reception

When an FM stereo broadcast is hard to receive or noisy, press REPEAT ST/MONO to switch to the monaural reception. The STEREO indicator disappears from the display.



To restore the stereo reception, press REPEAT ST/MONO again so that the STEREO indicator lights up.

To change FM/AM tuning interval

The unit's default tuning interval is 100 kHz/step for FM reception and 10 kHz/step for AM. You can change this setting to 50 kHz/step for FM and/or 9 kHz/step for AM when using the unit in an area of different frequency allocation system.

- 1 Press TUNER/BAND to select "FM" or "AM".
- 2 While holding down STOP/CLEAR ■ on the unit, press VOLUME + repeatedly to select the desired tuning interval.

Presetting Stations

You can preset 20 FM and 20 AM stations.

- There is a time limit in doing the following steps. If the setting is canceled before you finish, start from step 1 again.

- 1 **Tune in the station you want to preset.**

- See "Tuning In a Station" on the left.

- 2 **Press PROGRAM.**

The PROGRAM indicator and "00" start blinking on the display.



- 3 **Press PRESET ▼ or ▲ (or PRE DOWN II/◀ or PRE UP ▶/II on the remote control) to specify the desired preset number.**

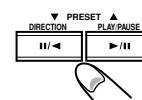

- 4 **To preset more stations, repeat steps 1 to 3 above, allocating a different preset number to each station.**



When a new station is stored

The station previously memorized with the same preset number is erased. (The frequency of the new station replaces the previous frequency in memory.)

Tuning In a Preset Station

- 1 **Press TUNER/BAND to select tuner mode.**



- 2 **Press TUNER/BAND to select the band, FM or AM.**

- 3 **Press PRESET ▼ or ▲ (or PRE DOWN II/◀ or PRE UP ▶/II on the remote control) to select the desired preset number.**

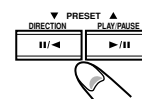

Playing Back CDs

This unit can play back audio CDs and CD-R/RW discs.



Loading a Disc

1 Press **CD/RANDOM** to select CD mode.



2 Press **▲ OPEN/CLOSE**.
The disc tray slides out.



3 Load a disc with the label side facing up.

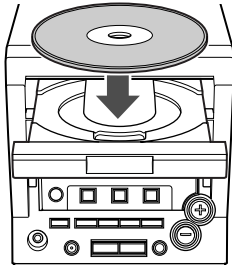

4 Press **▲ OPEN/CLOSE** to close the disc compartment.
The total number of tracks and the playing time of the disc appear on the display.



Basic CD Operations

1 Press **▶/II** to start playback.
The ▶ indicator lights up and the track number and elapsed playing time of the current track appear on the display.



2 To stop playback, press **■**.



To interrupt playback

Press **▶/II**.

The ▶ indicator and the playing time starts blinking.



To resume playback, press **▶/II** again.

To select a desired track

Press **◀◀** or **▶▶** repeatedly until the desired track appears on the display.

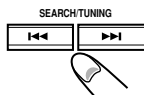

To search for a particular point during playback

Press and hold **◀◀** or **▶▶** to locate the desired point.



Program Play

You can arrange the order in which the tracks are played before you start playing. You can program up to 60 tracks.

1 In stop mode, press **PROGRAM**.

The PROGRAM indicator starts blinking.



2 Press **◀◀** or **▶▶** repeatedly to select the desired track.

The current program number starts blinking.



3 Press **PROGRAM** to store the selected track.

“00” and the next program number appear on the display.



4 Repeat steps 2 and 3 to store other tracks.

- You cannot program more than 60 tracks. If you attempt to do it, “FULL” will flash on the display.

To review the programmed sequence

Press PROGRAM repeatedly in stop mode. The program number and track number are displayed in succession.



To modify the program

Press PROGRAM repeatedly to select the program number with which you want to change the track, then repeat steps 2 and 3 above.



To play the programmed tracks

Press **▶/II**.

- During program play, you can press **◀◀** or **▶▶** to select the desired track in the program.



notes If you press **REPEAT ST/MONO** during program play

The current track or all programmed tracks are played repeatedly.

To clear the program

Press **■** in stop mode. The PROGRAM indicator disappears from the display.



- The stored program is cleared when the disc compartment is opened.

Random Play

You can play all the tracks in random order.

Press CD/RANDOM before or during playing.

The RANDOM indicator lights up.



To exit random play mode, press CD/RANDOM again. The RANDOM indicator goes off.

- Activating the REPEAT ONE function during random play mode disables the random play mode.
- It is not possible to activate the random play function during program play mode.

Repeat Play

You can play the current track or the whole disc repeatedly.

Press REPEAT ST/MONO repeatedly to select either of the following repeat play modes:

REPEAT ONE: repeats the current track.
REPEAT ALL: repeats the whole disc.



The current track or the whole disc is played repeatedly until you press ■.

To exit repeat play mode, press REPEAT ST/MONO repeatedly so that the REPEAT indicator disappears from the display.

- Activating the random play function during REPEAT ONE play mode disables the repeat play mode.

Introductory Play

The introductory portions of tracks can be played back automatically.

Press INTRO.

The first 10-second portion of each of the tracks is played back in order.



To exit introductory play mode, press INTRO again.

- The introductory play function is also available during program play mode, random play mode and repeat play mode.

Displaying the Remaining Time during Playback

You can display the remaining time of the current track/disc and the elapsed time of the current track/disc during playing a CD.

Press REMAIN repeatedly to select one of the following time display modes:

REMAIN: shows the remaining time of the current track.
TOTAL REMAIN: shows the remaining time of the disc.
TOTAL: shows the elapsed time of the disc.
No indication: shows the elapsed time of the current track.



Playing Back Tapes

- Use only type I normal tapes.



The use of tapes longer than 120 minutes is not recommended, since characteristic deterioration may occur and these tapes easily jam in the pinch roller and the capstan.

Loading a Tape

- 1 Press **▲ EJECT** to open the tape deck door.

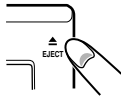

- 2 Insert a recorded tape with the open side down.

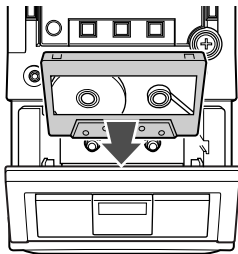

- 3 Close the tape deck door.

The TAPE indicator appears on the display.

Tape Playback

- 1 Press **TAPE/REV.MODE**.

REV. MODE



- 2 Press **II/◀** or **▶/II** to select the playback direction.

Playback starts.

“PLAY” appears on the display and the playback direction indicator moves to show the tape direction.

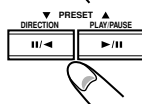

- 3 To stop playback, press **■**.



To interrupt playback

Press the last selected **II/◀** or **▶/II**.

“PAUSE” appears on the display.

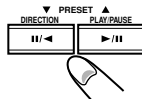

- If you press the button opposite to the last selected direction, playback starts in the reverse direction.

To resume playback, press **II/◀** or **▶/II** again.

Auto Reverse

Press **TAPE/REV.MODE** repeatedly to select the desired playback mode.

◀: playback on one side of the tape only.

◀▶: both sides are played once.

◀▶◀▶: both sides are played repeatedly up to 10 times until you press **■**.

REV. MODE



Rewind/Fast Forward

- 1 Press **◀◀** or **▶▶** to rewind or fast forward the tape.

“REW” or “FF” appears on the display.

SEARCH/TUNING



- 2 Press **■** to stop rewinding or fast forwarding.

STOP/CLEAR



- The tape stops automatically at the end of the rewinding or fast forwarding.

Recording

IMPORTANT:

- It may be unlawful to record or playback copyrighted material without the consent of the copyright owner.
- The recording level is automatically set correctly, so it is not affected by the volume control. Thus, during recording you can adjust the sound you are actually listening to without affecting the recording level.
- While recording, you can hear sound modes and/or the HBS sound effect through the speakers. However, the sound is recorded without these effects (see page 9).
- If recordings you have made have excessive noise or static, the unit may be too close to a TV. Increase the distance between the TV and the unit.
- Use only type I normal tapes for recording.
- The use of tapes longer than 120 minutes is not recommended, since characteristic deterioration may occur and these tapes easily jam in the pinch roller and the capstan.

To protect your recording

Cassettes have two small tabs on the back to prevent unexpected erasure or re-recording.

To protect your recording, remove these tabs.

To re-record on a protected tape, cover the holes with adhesive tape.

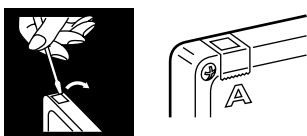

Recording Tapes

1 Load a recordable tape into the tape deck.

2 Press TAPE/REV.MODE repeatedly to either record one side or both sides of the tape.



- ≡: recording on one side only
- ≡>: recording on both sides

- When you select ≡>, make sure that there is no content that should not be lost is recorded on either side of the tape.

3 Press CD/RANDOM or TUNER/BAND to select the desired recording source.

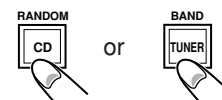

4 Prepare the source.

• For synchronous recording of a CD

Load the disc (see page 11).

- To start recording from the desired track, select the track by pressing ◀◀ or ▶▶ repeatedly in stop mode.
- To start recording from the desired point on a disc, play the disc and pause at the desired point by pressing ▶/||.

• For recording from the radio

Tune in the desired station (see page 10).

5 Press REC.

“REC” is displayed. The TAPE REC indicator and “||” light up and the recording direction indicator starts blinking.



6 While the recording direction indicator is blinking, press ||/◀ or ▶/|| to select the recording direction.

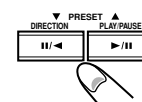

Recording starts.

“||” goes off. The TAPE REC indicator remains on the display. When recording a CD, the CD SYNC indicator also lights up.

To stop recording, press ■.

The selected recording source continues playing.

- During recording, it is not possible to pause or listen to another source. “REC ON” appears on the display.
- Recording continues to the end of the tape until you press ■ even after playback of the CD has finished.

Using the BEAT CUT function

When recording an AM broadcast, beats may occur. If this happens, press BEAT CUT on the remote control to select the better beat-cut position, “BEAT 01” or “BEAT 02”.

Using the Timers

There are three timers available – daily timer, recording timer and sleep timer.

Before using the timers, you need to set the built-in clock (see page 8).

Using Daily Timer

With the daily timer, you can wake to your favourite music or radio program.

How the daily timer actually works

At the timer-on time, the unit automatically turns on, sets the volume to the preset level, and starts playing the specified source (radio or CD). Then, at the timer-off time, the unit automatically turns off (on standby).

The timer setting remains in memory until you change it.

- There is a time limit in doing the following steps. If the setting is cancelled before you finish, start from step 1 again.

- 1 Press and hold DISPLAY MODE until “⌚ ON” starts blinking on the display, then press PROGRAM.**

The hour indication starts blinking.

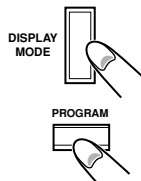

- 2 Press ◀◀ or ▶▶ to set the timer start hour, then press PROGRAM.**

The minute indication starts blinking.

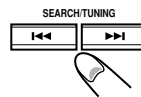

- 3 Press ◀◀ or ▶▶ to set the minute, then press PROGRAM.**

“⌚ ON” starts blinking again.

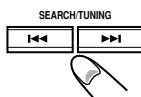

- 4 Press DISPLAY MODE so that “⌚ OFF” starts blinking on the display, then press PROGRAM.**

The hour indication starts blinking.

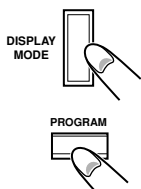

- 5 Set the time to stop playback following the same procedure as steps 2 and 3.**

- 6 Press DISPLAY MODE so that “TUNER,” “TAPE,” “CD” or “REC TU” appears on the display, then press PROGRAM.**

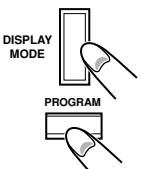

- 7 Press ◀◀ or ▶▶ to select the desired source, then press PROGRAM.**

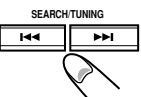

- 8 Prepare the source and set the volume.**

To listen to the radio, tune in the desired station.

To listen to a CD, load the disc.

- 9 Press TIMER ON/OFF SET (or TIMER on the remote control) to activate the timer.**

“⌚” lights up on the display.



- 10 Turn off the unit (on standby).**

When the preset time is reached, the selected source is played if the timer has been activated.



To deactivate the timer, press TIMER ON/OFF SET (or TIMER on the remote control).

“⌚” disappears from the display.

- The timer function is not activated if the starting and stopping times are the same.
- If the selected source (CD or TAPE) is not available when preset time is reached, TUNER is selected automatically.

Timer Recording

You can use the recording timer to record a preset radio station from a specified time and for a specified duration automatically.

- 1 Load a recordable tape into the tape deck.**

- If desired, select the tape reverse mode option.

- 2 Follow the “Using Daily Timer” procedure on the left. Select “REC TU” as the source for timer recording.**

- If the preset time is reached while the unit is on, the timer is not activated for timer recording.
- Once the recording is finished, the recording timer is replaced by the daily timer with the source selection changed from “REC TU” to “TUNER”.

Using Sleep Timer

With the sleep timer, you can fall asleep to music.
You can set the sleep timer using the remote control when the unit is turned on.

How the sleep timer actually works

The unit automatically turns off after the specified time length passes.

- 1 Press and hold SLEEP on the remote control until the desired time length appears on the display.**



The time length changes from 90 to 10 minutes in 10-minute steps.

- 2 Wait for a moment after specifying the time length.**

The SLEEP indicator lights up steadily on the display.

- Setting both the timer-off and sleep-off times causes the unit to enter standby mode when the earlier one of them is reached.

To change the shut-off time, repeat the procedure above.

To cancel the setting, press SLEEP so that the SLEEP indicator goes off.

- The sleep timer is also canceled when you turn off the unit.

Troubleshooting

If you are having a problem with your unit, check this list for a possible solution before calling for service.

If you cannot solve the problem from the hints given here, or the unit has been physically damaged, call a qualified person, such as your dealer, for service.

Symptom	Cause	Action
No sound is heard.	<ul style="list-style-type: none"> • Connections are incorrect or loose. • Headphones are connected. 	<ul style="list-style-type: none"> • Check all connections and make corrections. (See pages 6 and 7.) • Disconnect the headphones.
Hard to listen to broadcasts because of noise.	<ul style="list-style-type: none"> • Antennas are disconnected. • The AM loop antenna is too close to the unit. • The FM antenna is not properly extended and positioned. 	<ul style="list-style-type: none"> • Reconnect the antennas correctly and securely. • Change the position and direction of the AM loop antenna. • Extend the FM antenna at the best position.
The disc tray does not open or close.	The AC power cord is not plugged in.	Plug the AC power cord.
The disc does not play.	The disc is placed upside down.	Place the disc with the label side up.
The disc sound is discontinuous.	The disc is scratched or dirty.	Clean or replace the disc. (See page 18.)
The cassette holder cannot be opened.	Power supply from the AC power cord has been cut off while the tape was running.	Turn on the unit.
Impossible to record.	Small tabs on the back of the cassette are removed.	Cover the holes with adhesive tape.
Operations are disabled.	The built-in microprocessor may malfunction due to external electrical interference.	Unplug the AC power cord and then plug it back in.
Unable to operate the unit from the remote control.	<ul style="list-style-type: none"> • The path between the remote control and the remote sensor on the unit is blocked. • The batteries are exhausted. 	<ul style="list-style-type: none"> • Remove the obstruction. • Replace the batteries.

Maintenance

To get the best performance of the unit, keep your discs, tapes, and mechanism clean.

Handling discs



- Remove the disc from its case by holding it at the edge while pressing the center hole lightly.
- Do not touch the shiny surface of the disc, or bend the disc.
- Put the disc back in its case after use to prevent warping.

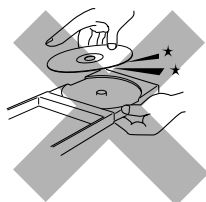

- Be careful not to scratch the surface of the disc when placing it back in its case.
- Avoid exposure to direct sunlight, temperature extremes, and moisture.

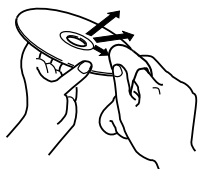

To clean the disc

Wipe the disc with a soft cloth in a straight line from center to edge.



DO NOT use any solvent — such as conventional record cleaner, spray, thinner, or benzine — to clean the disc.

Handling cassette tapes

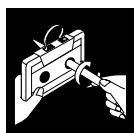

- If the tape is loose in its cassette, take up the slack by inserting a pencil in one of the reels and rotating.
- If the tape is loose, it may get stretched, cut, or caught in the cassette.



- Be careful not to touch the tape surface.



- Avoid the following places to store the tape:
 - In dusty places
 - In direct sunlight or heat
 - In moist areas
 - Near a magnet

Cassette decks

If the head, capstan, and pinch roller of the cassette deck become dirty, the following will occur:

- Impaired sound quality
- Discontinuous sound
- Fading
- Incomplete erasure
- Difficulty in recording

To clean the head, capstan, and pinch roller

Use a cotton swab moistened with alcohol.

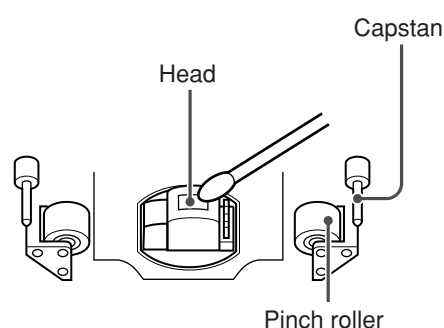

To demagnetize the head

Turn off the unit, and use a head demagnetizer (available at electronics and record shops).

Cleaning the unit

• Stains on the unit

Should be wiped off with a soft cloth. If the unit is heavily stained, wipe it with a cloth soaked in water diluted neutral detergent and wrung well, then wipe clean with a dry cloth.

• Since the unit may deteriorate in quality, become damaged or get its paint peeled off, be careful about the followings.

- DO NOT wipe it with a hard cloth.
- DO NOT wipe it strong.
- DO NOT wipe it with thinner or benzine.
- DO NOT apply any volatile substance such as insecticides to it.
- DO NOT allow any rubber or plastic to remain in contact with it for a long time.

Specifications

Amplifier section

Output power	
	60 W (30 W + 30 W) at 8 Ω (MAX.)
	22 W per channel, min. RMS, driven into 8 Ω at 1 kHz, with no more than 10% total harmonic distortion (IEC 268-3)
Audio output level	
PHONES:	800 mV/32 Ω
Speakers/Impedance	8 Ω - 16 Ω

Tuner

FM tuning range	
	At 100 kHz intervals: 87.50 MHz - 108.00 MHz
	At 50 kHz intervals: 87.50 MHz - 108.00 MHz
AM tuning range	
	At 10 kHz intervals: 530 kHz - 1 710 kHz
	At 9 kHz intervals: 531 kHz - 1 602 kHz

CD player

Dynamic range	60 dB
Signal-to-noise ratio	60 dB
Wow and flutter	Unmeasurable

Cassette deck

Frequency response	
Normal (type I):	100 Hz - 12 000 Hz
Wow and flutter	0.35% (WRMS)

General

Power requirement	AC 110 V - 127 V/220 V - 240 V \sim adjustable with the voltage selector, 50 Hz/60 Hz
Power consumption	40 W (operation mode) 6 W (standby mode)
Dimensions	160 mm \times 269.5 mm \times 340 mm (W/H/D)
Mass	5 kg

Speaker

Speaker unit	Woofer: 10.2 cm cone \times 1 Tweeter: 5.1 cm cone \times 1
Impedance	8 Ω
Dimensions	160 mm \times 269.5 mm \times 200 mm (W/H/D)
Mass	2 kg/piece

Supplied accessories

See page 6.

Design and specifications are subject to change without notice.

Mains (AC) Line Instruction (not applicable for Europe, U.S.A., Canada, Australia, and U.K.)

Instrucción sobre la línea de la red (CA) (no aplicable para Europa, EE.UU., Canadá, Australia, ni el Grã-Bretanha)

Instrução sobre a tensão da rede eléctrica (CA) (não aplicável para a Europa, os E.U.A., o Canadá, a Austrália e o Reino Unido)

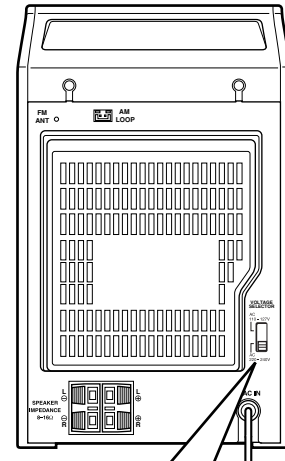

IMPORTANT for mains (AC) line

BEFORE PLUGGING IN, check that your mains (AC) line voltage corresponds with the position of the voltage selector switch provided on the outside of this equipment and, if different, reset the voltage selector switch, to prevent a damage or risk of fire/electric shock.

IMPORTANTE para la línea de la red (CA)

ANTES DE ENCHUFAR EL EQUIPO, compruebe si la tensión de la línea de la red (CA) corresponde con la posición del selector de tensión situado en la parte exterior del equipo, y si es diferente, reajuste el selector de tensión para evitar el riesgo de incendios/ descargas eléctricas.

IMPORTANTE para a ligação à tensão da rede (CA)

ANTES DE LIGAR O APARELHO A UMA TOMADA DA REDE, verifique se a tensão da rede CA corresponde à posição do selector de voltagem localizado na parte externa deste equipamento. Caso não corresponda, reajuste o selector de voltagem a fim de evitar avarias ou riscos de incêndio e choque elétrico.

VOLTAGE SELECTOR

AC
110 - 127V



AC
220 - 240V

JVC
VICTOR COMPANY OF JAPAN, LIMITED