



DVD Changer

# DV-CP702

Instruction Manual

Thank you for purchasing an Onkyo DV-CP702 DVD Changer. Read this manual carefully before using your new DVD Changer. A good understanding of its features and operation will allow you to achieve optimum performance and enjoyment.

Keep this manual for future reference.

## Contents

Important Safety Instructions.....	3
Precautions .....	4
Introduction .....	6
Controls & Connectors .....	10
Before Using the DV-CP702 .....	15
Connecting the DV-CP702 .....	16
Connecting RI-compatible AV Components .....	19
Powering Up & Setting Up the DV-CP702 .....	20
Basic Playback .....	21
Advanced Playback .....	31
Configuring the DV-CP702 .....	38
Troubleshooting .....	45
Specifications .....	47



# Contents

<b>Important Safety Instructions .....</b>	<b>3</b>	<b>Advanced Playback.....</b>	<b>31</b>
<b>Precautions .....</b>	<b>4</b>	Locating Specific Points in Time .....	31
<b>Introduction .....</b>	<b>6</b>	Repeat Playback .....	31
Supplied Accessories.....	6	A-B Repeat Playback .....	32
DV-CP702 Features.....	6	Random Playback .....	32
Disc Notes.....	7	Memory Playback.....	33
DV-CP702-related Terminology.....	9	Selecting Camera Angles.....	34
<b>Controls &amp; Connectors.....</b>	<b>10</b>	Selecting Languages & Audio Formats.....	35
Front Panel .....	10	Selecting Subtitles.....	35
Display .....	11	Using Progressive Scanning .....	35
Rear Panel .....	12	Using Last Memory .....	36
Remote Controller.....	13	Displaying Information.....	37
<b>Before Using the DV-CP702 .....</b>	<b>15</b>	<b>Configuring the DV-CP702.....</b>	<b>38</b>
Installing the Remote Controller's Batteries.....	15	Using the Onscreen Setup Menus .....	39
Using the Remote Controller.....	15	Picture Menu .....	39
<b>Connecting the DV-CP702.....</b>	<b>16</b>	Audio Menu .....	41
Before Making Any Connections.....	16	Language Menu .....	41
AV Cables & Connectors .....	16	Display Menu .....	42
Connecting Your TV or Projector .....	17	Operation Setting Menu .....	43
Connecting Your Hi-Fi Amp .....	18	Initial Setup Menu .....	44
Connecting for Dolby Digital or DTS .....	18	Selecting Other Languages.....	44
<b>Connecting RI-compatible AV Components..</b>	<b>19</b>	Language Code List.....	44
Connection Diagram .....	19	<b>Troubleshooting .....</b>	<b>45</b>
<b>Powering Up &amp; Setting Up the DV-CP702.....</b>	<b>20</b>	<b>Specifications .....</b>	<b>47</b>
Powering Up the DV-CP702 .....	20		
First Time Setup.....	20		
<b>Basic Playback.....</b>	<b>21</b>		
Loading & Removing Discs.....	21		
Loading Discs During Playback .....	21		
Selecting Discs .....	22		
Starting, Pausing & Stopping Playback .....	22		
Navigating Disc Menus .....	24		
Selecting Titles & Chapters by Number .....	25		
Using the Disc Navigator .....	26		
Memory Playback in the Disc Navigator .....	27		
Selecting Tracks by Number.....	28		
Fast Forward & Reverse .....	28		
Frame-by-Frame Playback .....	29		
Slow-motion Playback.....	29		
Adjusting the Display Brightness .....	29		
Using JPEG CDs .....	30		
Using Chain Mode .....	30		

**WARNING:**

TO REDUCE THE RISK OF FIRE OR ELECTRIC SHOCK, DO NOT EXPOSE THIS APPARATUS TO RAIN OR MOISTURE.

**CAUTION:**

TO REDUCE THE RISK OF ELECTRIC SHOCK, DO NOT REMOVE COVER (OR BACK). NO USER-SERVICEABLE PARTS INSIDE. REFER SERVICING TO QUALIFIED SERVICE PERSONNEL.



**WARNING**  
RISK OF ELECTRIC SHOCK  
DO NOT OPEN

**AVIS**  
RISQUE DE CHOC ELECTRIQUE  
NE PAS OUVRIR



The lightning flash with arrowhead symbol, within an equilateral triangle, is intended to alert the user to the presence of uninsulated "dangerous voltage" within the product's enclosure that may be of sufficient magnitude to constitute a risk of electric shock to persons.



The exclamation point within an equilateral triangle is intended to alert the user to the presence of important operating and maintenance (servicing) instructions in the literature accompanying the appliance.

# Important Safety Instructions

1. Read these instructions.
2. Keep these instructions.
3. Heed all warnings.
4. Follow all instructions.
5. Do not use this apparatus near water.
6. Clean only with dry cloth.
7. Do not block any ventilation openings. Install in accordance with the manufacturer's instructions.
8. Do not install near any heat sources such as radiators, heat registers, stoves, or other apparatus (including amplifiers) that produce heat.
9. Do not defeat the safety purpose of the polarized or grounding-type plug. A polarized plug has two blades with one wider than the other. A grounding type plug has two blades and a third grounding prong. The wide blade or the third prong are provided for your safety. If the provided plug does not fit into your outlet, consult an electrician for replacement of the obsolete outlet.
10. Protect the power cord from being walked on or pinched particularly at plugs, convenience receptacles, and the point where they exit from the apparatus.
11. Only use attachments/accessories specified by the manufacturer.
12. Use only with the cart, stand, tripod, bracket, or table specified by the manufacturer, or sold with the apparatus. When a cart is used, use caution when moving the cart/apparatus combination to avoid injury from tip-over.
13. Unplug this apparatus during lightning storms or when unused for long periods of time.
14. Refer all servicing to qualified service personnel. Servicing is required when the apparatus has been damaged in any way, such as power-supply cord or plug is damaged, liquid has been spilled or objects have fallen into the apparatus, the apparatus has been exposed to rain or moisture, does not operate normally, or has been dropped.
15. Damage Requiring Service  
Unplug the apparatus from the wall outlet and refer servicing to qualified service personnel under the following conditions:  
A. When the power-supply cord or plug is damaged,  
B. If liquid has been spilled, or objects have fallen into the apparatus,  
C. If the apparatus has been exposed to rain or water,  
D. If the apparatus does not operate normally by following the operating instructions. Adjust only those controls that are covered by the operating instructions as an improper adjustment of other controls may result in damage and will often require extensive work by a qualified technician to restore the apparatus to its normal operation,  
E. If the apparatus has been dropped or damaged in any way, and  
F. When the apparatus exhibits a distinct change in performance this indicates a need for service.
16. Object and Liquid Entry  
Never push objects of any kind into the apparatus through openings as they may touch dangerous voltage points or short-out parts that could result in a fire or electric shock.  
The apparatus shall not be exposed to dripping or splashing and no objects filled with liquids, such as vases shall be placed on the apparatus.  
Don't put candles or other burning objects on top of this unit.
17. Batteries  
Always consider the environmental issues and follow local regulations when disposing of batteries.
18. If you install the apparatus in a built-in installation, such as a bookcase or rack, ensure that there is adequate ventilation. Leave 20 cm (8") of free space at the top and sides and 10 cm (4") at the rear. The rear edge of the shelf or board above the apparatus shall be set 10 cm (4") away from the rear panel or wall, creating a flue-like gap for warm air to escape.

PORTABLE CART WARNING



S3125A

# Precautions

## DANGER:

VISIBLE AND INVISIBLE LASER RADIATION WHEN OPEN AND INTERLOCK FAILED OR DEFEATED. DO NOT STARE INTO BEAM.

## CAUTION:

THIS PRODUCT UTILIZES A LASER. USE OF CONTROLS OR ADJUSTMENTS OR PERFORMANCE OF PROCEDURES OTHER THAN THOSE SPECIFIED HEREIN MAY RESULT IN HAZARDOUS RADIATION EXPOSURE.

This unit contains a semiconductor laser system and is classified as a "CLASS 1 LASER PRODUCT." So, to use this model properly, read this Instruction Manual carefully. In case of any trouble, please contact the store where you purchased the unit. To prevent exposure to the laser beam, do not try to open the enclosure.



In some cases, this label is located on the rear panel. It indicates that:

1. This unit is a CLASS 1 LASER PRODUCT and employs a laser inside the cabinet.
2. To prevent the laser from being exposed, do not remove the cover. Refer servicing to qualified personnel.

## For U.S. model

The laser is covered by a housing which prevents exposure during operation or maintenance. However, this product is classified as a Laser Product by CDRH (Center for Devices and Radiological Health) which is a department of the Food and Drug Administration.

According to their regulations 21 CFR section 1002.30, all manufacturers who sell Laser Products must maintain records of written communications between the manufacturer, dealers and customers concerning radiation safety. If you have any complaints about instructions or explanations affecting the use of this product, please feel free to write to the address on the back page of this manual. When you write us, please include the model number and serial number of your unit.

In compliance with Federal Regulations, the certification, identification and the period of manufacture are indicated on the rear panel.

## FCC INFORMATION FOR USER

### CAUTION:

The user changes or modifications not expressly approved by the party responsible for compliance could void the user's authority to operate the equipment.

### NOTE:

This equipment has been tested and found to comply with the limits for a Class B digital device, pursuant to Part 15 of the FCC Rules. These limits are designed to provide reasonable protection against harmful interference in a residential installation. This equipment generates, uses and can radiate radio frequency energy and, if not installed and used in accordance with the instructions, may cause harmful interference to radio communications. However, there is no guarantee that interference will not occur in a particular installation. If this equipment does cause harmful interference to radio or television reception, which can be determined by turning the equipment off and on, the user is encouraged to try to correct the interference by one or more of the following measures:

- Reorient or relocate the receiving antenna.
- Increase the separation between the equipment and receiver.
- Connect the equipment into an outlet on a circuit different from that to which the receiver is connected.
- Consult the dealer or an experienced radio/TV technician for help.

## For Canadian model

For models having a power cord with a polarized plug:

**CAUTION:** TO PREVENT ELECTRIC SHOCK, MATCH WIDE BLADE OF PLUG TO WIDE SLOT, FULLY INSERT.

**NOTE:** This Class B digital apparatus complies with Canadian ICES-003.

## Modèle canadien

Sur les modèles dont la fiche est polarisée:

**ATTENTION:** POUR ÉVITER LES CHOCS ÉLECTRIQUES, INTRODUIRE LA LAME LA PLUS LARGE DE LA FICHE DANS LA BORNE CORRESPONDANTE DE LA PRISE ET POUSSER JUSQU'AU FOND.

**REMARQUE:** CET APPAREIL NUMÉRIQUE DE LA CLASSE B EST CONFORME À LA NORME NMB-003 DU CANADA.

## Precautions—Continued

### 1. Region Numbers

The DVD standard uses region numbers to control how discs can be played around the world, the world being divided into six regions. This unit will only play DVD discs that match its region number, which can be found on its rear panel (e.g., .

### 2. About this Manual

This manual explains how to use all of this unit's functions. Although the DVD standard offers many special features, not all discs use them all, so depending on the disc being played, this unit may not respond to certain functions. See the disc's sleeve notes for supported features.

When you attempt to use a DVD feature that is not available, this logo may appear onscreen, indicating that the feature is not supported by the current disc or this unit. 

### 3. Warranty

If you need to use the warranty, please provide the serial number printed on this unit's rear panel.

### 4. Recording Copyright

Unless it's for personal use only, recording copyrighted material is illegal without the permission of the copyright holder.

### 5. Power

#### WARNING

BEFORE PLUGGING IN THE UNIT FOR THE FIRST TIME, READ THE FOLLOWING SECTION CAREFULLY.

AC outlet voltages vary from country to country. Make sure that the voltage in your area meets the voltage requirements printed on this unit's rear panel (e.g., AC 120 V, 60 Hz).

### 6. Never Touch this Unit with Wet Hands

Never handle this unit or its power cord while your hands are wet or damp. If water or any other liquid gets inside this unit, have it checked by your Onkyo dealer.

### 7. Installing this Unit

- Install this unit in a well-ventilated location. Ensure that there's adequate ventilation all around this unit, especially if it's installed in an audio rack. If the ventilation is inadequate, the unit may overheat, leading to malfunction.
- Do not expose this unit to direct sunlight or heat sources, because its internal temperature may rise, shortening the life of the optical pickup.
- Avoid damp and dusty places, and places subject to vibrations from loudspeakers. Never put the unit on top of, or directly above a loudspeaker.
- Install this unit horizontally. Never use it on its side or on a sloping surface, because it may cause a malfunction.
- If you install this unit near a TV, radio, or VCR, the picture and sound quality may be affected. If this occurs, move this unit away from the TV, radio, or VCR.

### 8. Care

Occasionally, you should dust this unit all over with a soft cloth. For stubborn stains, use a soft cloth dampened with a weak solution of mild detergent and water. Dry the unit immediately afterwards with a clean cloth. Do not use abrasive cloths, thinners, alcohol, or other chemical solvents, because they may damage the finish or remove the panel lettering.

### 9. Handling Notes

- If you need to transport this unit, use the original packaging to pack it how it was when you originally bought it.
- Do not use volatile liquids, such as insect sprays, near this unit. Do not leave rubber or plastic items on this unit for a long time, because they may leave marks on the case.
- This unit's top and rear panels may get warm after prolonged use. This is normal.
- When you've finished using this unit, remove all discs and turn off the power.
- If you do not use this unit for a long time, it may not work properly the next time you turn it on, so be sure to use it occasionally.

### 10. To Obtain a Clear Picture

This unit is a high-tech, precision device. If the lens on the optical pickup, or the disc drive mechanism becomes dirty or worn, the picture quality may be affected. To maintain the best picture quality, we recommend regular inspection and maintenance (cleaning or worn part replacement) every 1,000 hours of use depending on the operating environment. Contact your Onkyo dealer for details.

### 11. Moisture Condensation

**Moisture condensation may damage this unit.**

**Read the following carefully:**

When you take a glass containing a cold drink outside on a summer's day, drops of water, called condensation, form on the outside of the glass. Similarly, moisture may condense on the lens of the optical pickup, one of the most important parts inside this unit.

- Moisture condensation can occur in the following situations:
  - The unit is moved from a cold place to a warm place.
  - A heater is turned on, or cold air from an air conditioner is hitting the unit.
  - In the summer, when this unit is moved from an air conditioned room to a hot and humid place.
  - The unit is used in a humid place.
- Do not use this unit when there's the possibility of moisture condensation occurring. Doing so may damage your discs and certain parts inside this unit. If condensation does occur, remove all discs and leave this unit turned on for two to three hours. By this time, the unit will have warmed up and any condensation will have evaporated. To reduce the risk of condensation, keep this unit connected to a wall outlet.

# Introduction

## Supplied Accessories

Make sure you have the following accessories:

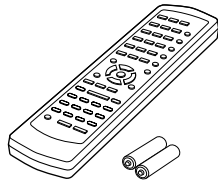

**Remote controller (RC-542DV) & 2 batteries (AA)**

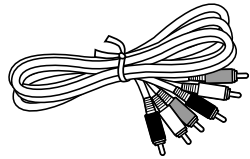

**AV connecting cable (RCA/phono)**



**S-Video connecting cable**

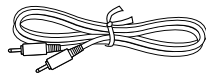

**RI cable**

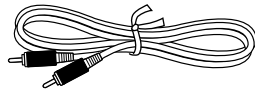

**Coaxial digital cable (U.S. model only)**

## DV-CP702 Features

### Highlights

- Dolby<sup>\*1</sup> Digital and DTS<sup>\*2</sup>
- Holds up to six discs
- Chain mode for successive disc playback
- DVD-Video playback
- Video CD playback
- Audio CD playback
- MP3/WMA<sup>\*3</sup> playback
- JPEG picture display and slideshow
- CD-R, CD-RW (Video CD, audio CD, MP3/WMA/JPEG)
- DVD-R, DVD-RW (DVD-Video)
- Direct digital path for signal purity
- Vector Linear Shaping Circuitry

### Video

- Advanced 54 MHz/10-bit video D/A converter
- Component video output
- S-Video and composite video outputs
- Title, chapter, track, or time search
- Pause/Still setting for enhanced display of single frames
- Frame-by-frame playback
- Slow motion playback (four speeds)
- Fast forward and reverse (five speeds)
- Last Memory function allows you to resume playback from a specific point on a DVD-Video disc or Video CD, even if that disc has been removed from the DV-CP702
- Repeat playback options include: Chapter, Title, 1 Disc, All Discs, Track, and Folder (MP3/WMA)
- Random playback options include: Title, 1 Disc, All Discs, and Folder (MP3/WMA)
- Supports 4:3 and 16:9 aspect ratio TVs
- Supports up to 8 soundtracks/languages
- Supports up to 32 subtitle languages
- Multiple camera angle support
- Parental Lock function
- Screen Saver function

### Audio

- Audiophile-class performance
- Direct digital path
- 192 kHz/24-bit D/A converter
- Coaxial digital output
- Optical digital output
- Analog output

### Others

- Load discs without stopping playback
- Dynamic Range Control setting
- Adjustable display brightness

\*1. Manufactured under license from Dolby Laboratories. "Dolby" and the double-D symbol are trademarks of Dolby Laboratories.

\*2. "DTS" is a trademark of Digital Theater Systems, Inc.

\*3.  Windows Media, and the Windows logo are trademarks, or registered trademarks of Microsoft Corporation in the United States and/or other countries.

## Introduction—Continued

### Disc Notes

#### Supported Discs

The DV-CP702 supports the following discs.

Disc	Logo	Format or file type
DVD-Video		*1
DVD-R		DVD-Video
DVD-RW		DVD-Video
Video CD		Version 1.1 and 2.0
Audio CD*2		PCM and DTS
CD-R*3		Video CD, audio CD, MP3, WMA, JPEG
CD-RW		Video CD, audio CD, MP3, WMA, JPEG
JPEG CD		JPEG

\*1. The North American model will only play Region 1, NTSC DVD-Video discs. The Australian model will only play Region 4, PAL DVD-Video discs, although it can be set to AUTO, in which case it will also play Region 4 NTSC DVD-Video discs (see page 39).

\*2. Some audio CDs feature copy protection that doesn't conform to the official CD standard. Since these are nonstandard discs, they may not play properly in the DV-CP702.

\*3. The DV-CP702 supports CD-R and CD-RW discs recorded in Video CD format, audio CD format, or ISO9660 Level 2 format with MP3, WMA, and JPEG files. It also supports DVD-R and DVD-RW discs recorded in DVD-Video format. However, some CD-R, CD-RW, DVD-R, and DVD-RW discs may not work properly for any of the following reasons: incomplete disc finalization, disc burner characteristics, disc characteristics, the disc is damaged or dirty. See the manual supplied with your disc burner for more information. Condensation or dirt on the optical pickup lens can also affect playback.

- The DV-CP702 does not support disc types not listed.
- The DV-CP702 does not support the following disc types even if they bear one of the logos shown above: DVD-RAM, DVD+R, DVD+RW, DVD Audio, Super Audio CD, Photo CD, CD-G.
- The DV-CP702 supports 8 cm and 12 cm discs.
- Don't use discs with an unusual shape, such as those shown below, because you may damage the DV-CP702.



- Don't use discs that have residue from adhesive tape, rental discs with peeling labels, or discs with custom-made labels or stickers. Doing so may damage the DV-CP702 and you may not be able to remove the disc properly.

#### About playing copy-controlled CDs

Some copy-controlled CDs may not conform to official CD standards. They are special discs and may not play on the DV-CP702.

### DVD Region Numbers



The North American DV-CP702 supports only Region 1 DVD-Video discs bearing this logo.



The Australian DV-CP702 supports only Region 4 DVD-Video discs bearing this logo.

If you attempt to play a disc intended for another region, the message "Cannot play discs with this region code" appears onscreen.

### Function Support

The following icons are used throughout this manual to indicate which functions can be used with the various disc formats and file types.

Icon	Disc format or file type
	DVD-Video
	Video CD
	Audio CD
	MP3 file
	WMA file
	JPEG file

### Unsupported DVD Features

The DVD standard offers many special features, including multiple soundtracks, subtitles, camera angles, and so on. However, not all discs employ all of these features. When you attempt to use a feature that is not used by the current disc, for example, you press the remote controller's [AUDIO] button while playing a disc with only one soundtrack, this icon will appear onscreen, indicating that the feature is not supported by the current disc.



Similarly, if a disc uses features that are not supported by the DV-CP702, for example, special interactive menu functions, this icon will appear onscreen, indicating that the feature is not supported by the DV-CP702.



### Disc Content Organization

#### ■ DVD-Video Format

DVD-Video discs contain titles, which are usually subdivided into chapters.

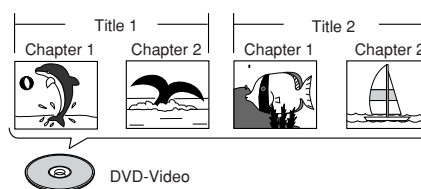

#### ■ Video CD Format

Video CDs contain tracks.

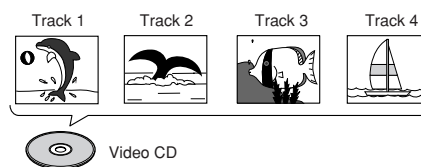

## Introduction—Continued

### ■ Audio CD Format

Audio CDs contain tracks.

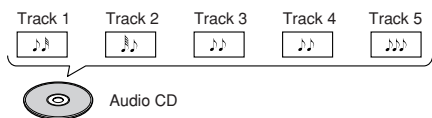

### ■ MP3/WMA Files

MP3 and WMA files are typically organized into folders. The DV-CP702 handles MP3 and WMA files as tracks.

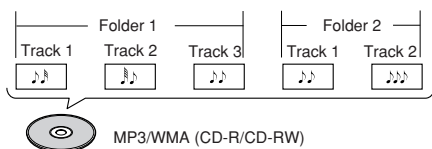

### ■ JPEG Files

JPEG picture files are typically organized into folders. The DV-CP702 handles JPEG files as tracks.

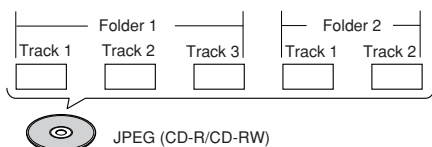

### Video CDs

The DV-CP702 supports Version 1.1 and Version 2.0 of the Video CD standard. Version 2.0 supports PBC (Playback Control).

#### • Video CD (Version 1.1)

The contents of Video CDs that conform to Version 1.1 of the Video CD standard are played as tracks.

#### • Video CD with PBC (Version 2.0)

In addition to the functions supported by Version 1.1, Version 2.0 offers playback control via interactive menus and search functions. Note that the DV-CP702 doesn't support all Video CD PBC functions.

### MP3/WMA/JPEG Compatibility

- The DV-CP702 can play/display MP3, WMA, and JPEG files recorded on CD-R and CD-RW discs.
- Discs must be in ISO9660 Level 2 format (folders can be up to eight levels deep).
- Discs must be finalized.
- The DV-CP702 can only recognize the first session on multi-session discs.
- You can determine the order in which the DV-CP702 plays/displays your MP3/WMA songs and JPEG pictures by prefixing file and folder names with a three-digit number. For example 001.Root, 002.Folder, and so on, and 001.Track.mp3, 002.Track.mp3, and so on.
- Only the first eight characters of folder and track names (excluding the filename extension) are displayed.
- The folder numbered "001" appears as "ROOT" in the Disc Navigator.
- The DV-CP702 supports up to 999 folders and up to 672 files per folder.
- If you try to play an incompatible file, the message "This format cannot be played" appears on the display.

### ■ MP3

- MP3 files must be MPEG1 Audio Layer 3 format, 44.1 or 48 kHz, fixed bit-rate.
- MP3 files must have a ".mp3" or ".MP3" filename extension.
- Variable bit-rates (VBR) from 64 kbps to 384 kbps are supported. (Playing times may display incorrectly with VBR.)

### ■ WMA

- WMA files must have the copyright option turned off.
- Sampling rates 44.1/48 kHz are supported.
- Variable bit-rates (VBR) from 16 kbps to 192 kbps are supported. (Playing times may display incorrectly with VBR.)
- WMA files must have a ".wma" or ".WMA" or ".ASF" filename extension.

### ■ JPEG

- JPEG files must have a ".jpg" or ".JPG" or ".JPEG" filename extension.
- Baseline JPEG files are supported. Progressive JPEG files are not.
- Only JPEG files with the following brightness/color difference ratios are supported: 4:4:4, 4:2:2, and 4:1:1.
- JPEG files must be less than 5 megabytes in size.

### Handling Discs

- Never touch the underside of a disc. Always hold discs by the edge, as shown.

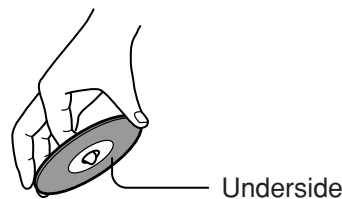

- Never attach adhesive tape or sticky labels to discs.



### Cleaning Discs

- For best results, keep your discs clean. Fingerprints and dust can affect the sound and picture quality and should be removed as follows. Using a clean soft cloth, wipe from the center outwards, as shown. Never wipe in a circular direction.



- To remove stubborn dust or dirt, wipe the disc with a damp soft cloth, and then dry it with a dry cloth.
- Never use solvent-based cleaning fluids, such as thinner or benzene, commercially available cleaners, or antistatic sprays intended for vinyl records, because they may damage the disc.



## Introduction—Continued

### Storing Discs

- Don't store discs in places subject to direct sunlight, or near heat sources.
- Don't store discs in places subject to moisture or dust, such as in a bathroom or near a humidifier.
- Always store discs in their cases and vertically. Stacking, or putting objects on unprotected discs may cause warping, scratches, or other damage.

### Copyright

It is forbidden by law to copy, broadcast, show, broadcast on cable, play in public, or rent copyrighted material without permission.

DVD-Video discs are copy-protected, and any recordings made from these discs will be distorted.

This product incorporates copyright protection technology that is protected by method claims of certain U.S. patents and other intellectual property rights owned by Macrovision Corporation and other rights owners. Use of this copyright-protection technology must be authorized by Macrovision Corporation, and is intended for home and other limited viewing uses only, unless otherwise authorized by Macrovision Corporation. Reverse engineering or disassembly is prohibited.

### DV-CP702-related Terminology

- **CD-R (compact disc recordable):** A type of CD that can be recorded only once. Can be used to make Video-CDs, audio CDs, or MP3/WMA/JPEG discs.
- **CD-RW (compact disc rewritable):** A type of CD that can be recorded many times. Can be used to make Video-CDs, audio CDs, MP3/WMA/JPEG discs.
- **Chapter:** Titles on DVD-Video discs can be subdivided into chapters.
- **Component video:** A video connection format that separates the luminance (Y) and color difference signals (Pr, Pb), providing better picture quality than S-Video.
- **Composite video:** A video connection format that mixes the luminance and color signals together.
- **Dolby Digital:** The multi-channel digital surround sound format used on most DVD-Videos.
- **Dolby Pro Logic:** The four-channel analog surround sound format that can be encoded in normal stereo soundtracks and used with VHS video cassettes, analog TV broadcasts, and other analog stereo systems.
- **Downmixing:** The process of mixing multiple audio channels into fewer channels. For example, a 5.1-channel surround mix can be downmixed into two channels for reproduction on stereo systems.
- **Downsampling:** The process of reducing the sampling rate of digital audio.
- **DTS (Digital Theater System):** The 5.1-channel surround format that uses less compression for faithful reproduction.
- **DVD-R (DVD recordable):** A type of DVD disc that can be recorded only once. Can be used to make DVD-Video discs or to store computer data.
- **DVD-RW (DVD rewritable):** A type of DVD disc that can be recorded many times. Can be used to make DVD-Video discs or to store computer data.
- **DVD-Video:** The format for storing movies on DVD, with interactive menus, multiple language soundtracks, subtitles, camera angles, and so on.
- **Field:** In interlaced scanning, a field is a single scan of the screen. There are two fields per frame.
- **Frame:** An individual TV picture is called a frame. With the NTSC color system there are 30 frames per second.
- **Interlaced scanning:** TV pictures are made by scanning the screen in horizontal lines from top to bottom. With Interlaced scanning, two scans (*fields*) are used to make each picture (*frame*). *Contrast with* Progressive scanning.
- **JPEG (Joint Photographic Experts Group):** The compressed file format used to store digital photos.
- **LFE (low-frequency effects):** The surround-sound channel used for low-frequency effects.
- **Linear PCM:** The uncompressed digital audio format used for audio CDs. PCM stands for *Pulse Code modulation*.
- **MP3 (MPEG 1 Audio Layer 3):** Popular compressed file format for storing digital music.
- **MPEG1 (Moving Picture Experts Group 1):** The compressed digital video format used for Video CDs.
- **MPEG2 (Moving Picture Experts Group 2):** The compressed digital video format used for DVD-Videos, offering better picture quality than MPEG1.
- **NTSC:** The color TV system used in the United States, Japan, Taiwan, and Korea.
- **PAL:** The color TV system used in most of Europe, the United Kingdom, Australia, Brazil, and China.
- **PBC (Playback Control):** Version 2.0 of the Video CD standard supports interactive menus and search functions.
- **Progressive scanning:** TV pictures are made by scanning the screen in horizontal lines from top to bottom. With progressive scanning, each picture (*frame*) is made by scanning the entire screen in one go, resulting in a clearer and stabler picture. *Contrast with* Interlaced scanning.
- **S-Video:** A video connection format that separates the luminance (Y) and color (C) signals, providing better picture quality than composite video.
- **Title:** Movies on DVD-Video are called titles.
- **Video CD:** The format for storing movies on CD.
- **WMA (Windows Media Audio):** A compressed file format for storing digital music.

# Controls & Connectors

## Front Panel

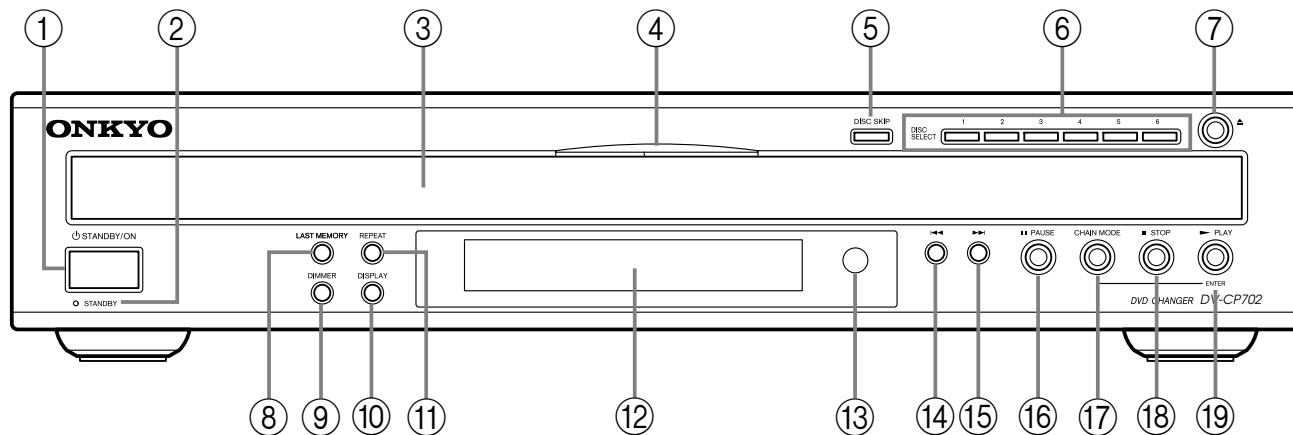

For detailed information, refer to the pages in parenthesis.



- ① **STANDBY/ON button (20)**  
This button is used to set the DV-CP702 to On or Standby.  
Don't turn on the power until you've completed, and double checked all connections (page 16).
- ② **STANDBY indicator (20)**  
This indicator lights up when the DV-CP702 is in Standby mode.
- ③ **Disc tray (21)**  
The disc tray has six bays for loading up to six discs.
- ④ **Disc tray light**  
This light illuminates the disc tray. It comes on when the DV-CP702 is turned on, and is brighter while the disc tray is open.
- ⑤ **DISC SKIP button (21, 22)**  
This button is used to select the disc bays (i.e., rotate the disc tray) when loading or removing discs, and to select discs for playback.
- ⑥ **DISC SELECT 1–6 buttons (22)**  
These buttons are used to select discs. Playback starts automatically when a disc is selected with these buttons.
- ⑦ **Open/Close [▲] button (21)**  
This button is used to open and close the disc tray.
- ⑧ **LAST MEMORY button (36)**  
This button is used with the Last Memory function.
- ⑨ **DIMMER button (29)**  
This button is used to adjust the display brightness.
- ⑩ **DISPLAY button (37)**  
This button is used to display information about the current disc, title, chapter, or track, including the elapsed time, remaining time, total time, and so on.
- ⑪ **REPEAT button (31)**  
This button is used with the Repeat function.
- ⑫ **Display**  
See "Display" on page 11 for more information.
- ⑬ **Remote control sensor (15)**  
This sensor receives control signals from the remote controller.
- ⑭ **Previous [◀◀] button (25, 28)**  
This button is used to select the previous chapter or track. During playback it selects the beginning of the current chapter or track.
- ⑮ **Next [▶▶] button (25, 28)**  
This button is used to select the next chapter or track.
- ⑯ **PAUSE [⏸] button (22)**  
This button is used to pause playback.
- ⑰ **CHAIN MODE button (30)**  
This button is used with the Chain mode function.
- ⑱ **STOP [■] button (22)**  
This button is used to stop playback.
- ⑲ **PLAY/ENTER [▶] button (22)**  
This button is used to start playback and to cancel fast forward and fast reverse. It's also used to start Chain mode playback.

## Controls & Connectors—Continued

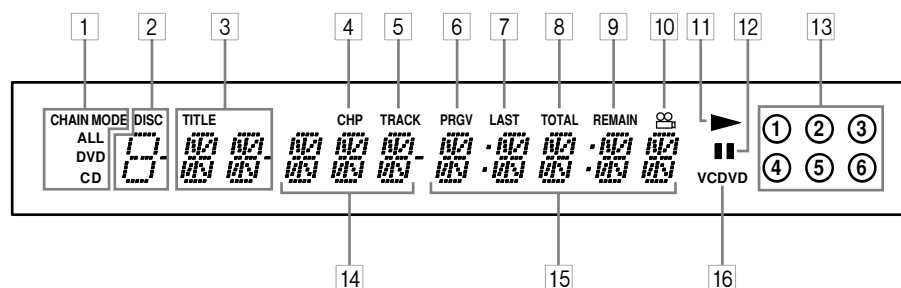
### Display



For detailed information, refer to the pages in parenthesis.

- 1 **CHAIN MODE, ALL, DVD & CD indicators (30)**  
The CHAIN MODE indicator appears when the Chain mode function is on. The ALL, DVD, and CD indicators show the type or Chain mode selected.
- 2 **DISC indicator (22)**  
The number of the currently selected disc appears here.
- 3 **TITLE indicator (22)**  
While stopped, the total number of titles on the current DVD-Video disc is displayed here. During playback, the number of the current title is displayed.
- 4 **CHP indicator**  
This indicator appears while the number of the current chapter is being displayed.
- 5 **TRACK indicator**  
This indicator appears while track numbers are being displayed. While stopped, the total number of tracks on the current Video CD, audio CD, or MP3/WMA disc are displayed. During playback, the number of the current track is displayed.
- 6 **PRGV indicator (35)**  
This indicator appears when the Progressive Scanning function is on.
- 7 **LAST indicator (36)**  
This indicator appears when the Last Memory function has been set.
- 8 **TOTAL indicator (37)**  
This indicator appears while the total time is being displayed.
- 9 **REMAIN indicator (37)**  
This indicator appears while the remaining time is being displayed.
- 10 **Camera angle  indicator (34)**  
This indicator appears if the DVD-Video disc being played features multiple camera angles.
- 11 **Play ► indicator (22)**  
This indicator is shown during playback.
- 12 **Pause  indicator (10)**  
This indicator appears when playback is paused.

### 13 Disc indicators 1–6 (21)

These indicators show how many discs are loaded. The number of the current disc has a circle around it. When the disc tray is closed, all of the disc indicators appear until the DV-CP702 has checked each bay for the presence of a disc. If a bay is found to have no disc, the corresponding indicator disappears.

### 14 Chapter & track number

Chapter and track numbers appears here.

### 15 Time display

Time information, such as total time, remaining time, and so on, is displayed here in hours, minutes, and seconds. Other messages are also displayed.

### 16 VCDVD indicator

This indicator shows the type of disc currently selected:  
**DVD:** DVD-Video, DVD-R, or DVD-RW  
**VCD:** Video CD  
**CD:** Audio CD, MP3/WMA/JPEG CD-R, or CD-RW

## Controls & Connectors—Continued

### Rear Panel

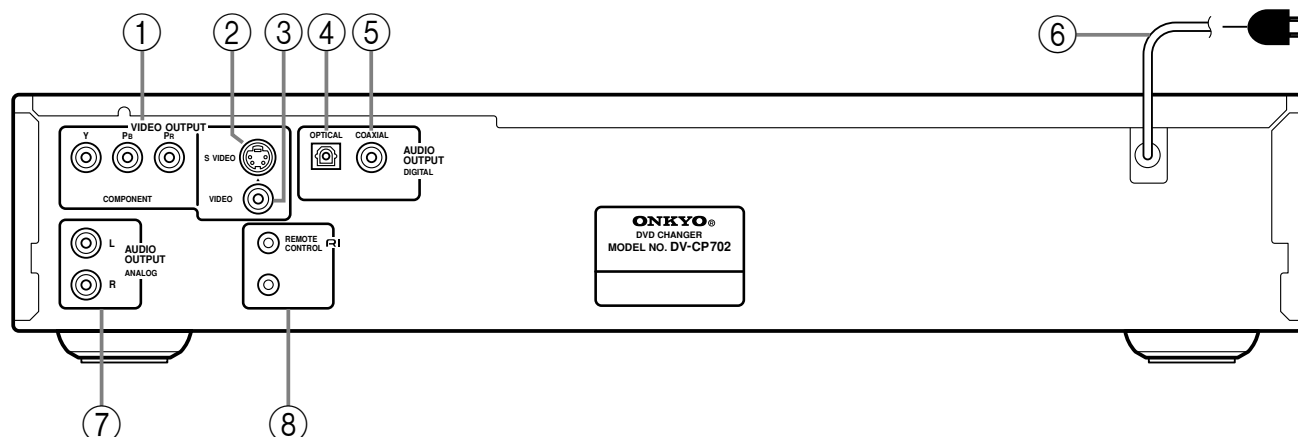

For detailed information, refer to the pages in parenthesis.

- ① **COMPONENT VIDEO OUTPUT (17)**  
These RCA/phono connectors can be used to connect a TV or projector with component video inputs.
- ② **S VIDEO OUTPUT (17)**  
This connector can be used to connect a TV or projector with an S-Video input.
- ③ **VIDEO OUTPUT (17)**  
This RCA/phono connector can be used to connect a TV or projector with a composite video input.
- ④ **OPTICAL AUDIO OUTPUT (18)**  
This optical digital audio output can be connected to an optical digital audio input on a hi-fi amp, AV receiver, or surround sound decoder (Dolby Digital, DTS).
- ⑤ **COAXIAL AUDIO OUTPUT (18)**  
This coaxial digital audio output can be connected to an coaxial digital audio input on a hi-fi amp, AV receiver, or surround sound decoder (Dolby Digital, DTS).
- ⑥ **Power cord (20)**  
This power cord should be connected to a suitable wall outlet.
- ⑦ **ANALOG AUDIO OUTPUT (17, 18)**  
These RCA/phono connectors can be connected to analog audio inputs on a hi-fi amp, AV receiver, or surround sound decoder (Dolby Pro Logic).
- ⑧ **RI REMOTE CONTROL (19)**  
These **RI** (Remote Interactive) connectors can be connected to the **RI** connectors on your other Onkyo AV components for interactive control.

## Controls & Connectors—Continued

### Remote Controller

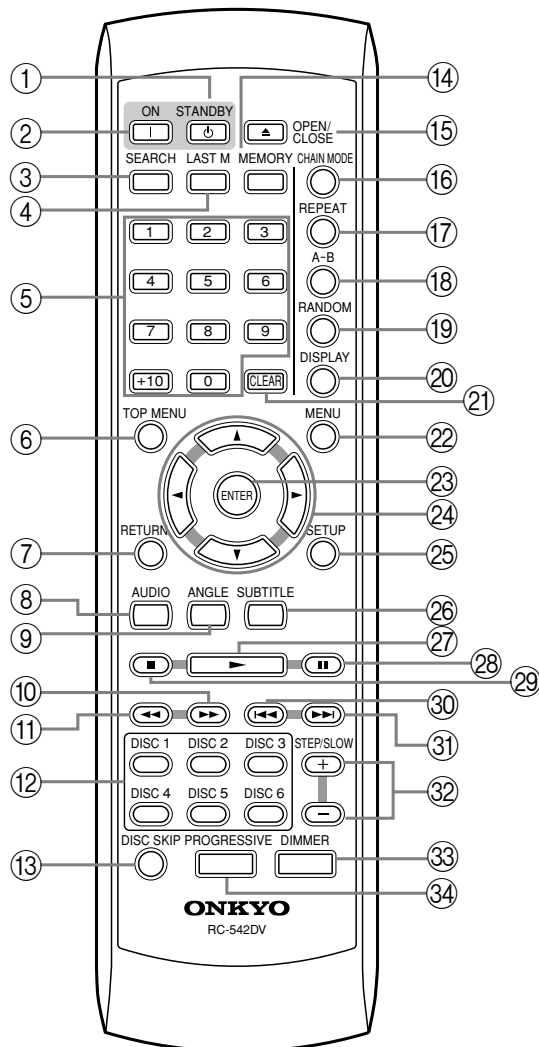

For detailed information, refer to the pages in parenthesis.

- ① **STANDBY button (20)**  
This button is used to set the DV-CP702 to Standby.
- ② **ON button (20)**  
This button is used to turn on the DV-CP702. Don't turn on the DV-CP702 until you've completed, and double checked all connections (page 16).
- ③ **SEARCH button (25, 28, 31)**  
This button is used to search for titles, chapters, tracks, and specific points in time.
- ④ **LAST M button (36)**  
This button is used with the Last Memory function.
- ⑤ **Number buttons (25, 28, 31)**  
These buttons are used to enter title, chapter, and track numbers and to enter times for locating specific points in time.  
To enter a single-digit number, simply press the corresponding button. To enter a double-digit number, enter the numbers in order from left-to-right (e.g., to enter 14, press [1] then [4].  
The [+10] button is used to enter multiples of ten (i.e., 10, 20, 30, and so on). For example, to enter the number 25, press the [+10] button twice followed by the [5] button.
- ⑥ **TOP MENU button (24)**  
This button is used to select the top menu.
- ⑦ **RETURN button (39)**  
This button is used to exit the onscreen setup menu and to restart menu playback.
- ⑧ **AUDIO button (35)**  
This button is used to select foreign language soundtracks and audio formats (e.g., Dolby Digital or DTS).
- ⑨ **ANGLE button (34)**  
This button is used to select different camera angles.
- ⑩ **Fast Forward [▶▶] button (28)**  
This button is used to start fast forward.
- ⑪ **Fast Reverse [◀◀] button (28)**  
This button is used to start fast reverse.
- ⑫ **DISC 1-6 buttons (22)**  
These buttons are used to select discs. Playback starts automatically when a disc is selected with these buttons.
- ⑬ **DISC SKIP button (21, 22)**  
This button is used to select the disc bays (i.e., rotate the disc tray) when loading or removing discs, and to select discs for playback.
- ⑭ **MEMORY button (33)**  
This button is used with the Memory Playback function.
- ⑮ **OPEN/CLOSE [▲] button (21)**  
This button is used to open and close the disc tray.
- ⑯ **CHAIN MODE button (30)**  
This button is used with the Chain mode function.

## Controls & Connectors—Continued

---

- ⑰ **REPEAT button (31)**  
This button is used to set the Repeat Playback functions.
- ⑱ **A–B button (32)**  
This button is used to set the A–B Repeat Playback function.
- ⑲ **RANDOM button (32)**  
This button is used with the Random Playback function.
- ⑳ **DISPLAY button (37)**  
This button is used to display information about the current disc, title, chapter, or track, including the elapsed time, remaining time, total time, and so on.
- ㉑ **CLEAR button**  
This button is used to cancel various functions.
- ㉒ **MENU button (24)**  
This button is used to select the menu.
- ㉓ **ENTER button**  
This button is used to start playback of the selected title chapter, or track and to confirm settings.
- ㉔ **[▲], [▼], [◀], [▶] buttons**  
These buttons are used to navigate DVD-Video menus and the onscreen setup menus.
- ㉕ **SETUP button (39)**  
This button is used to open and close the onscreen setup menus.
- ㉖ **SUBTITLE button (35)**  
This button is used to select subtitles.
- ㉗ **Play [▶] button (22)**  
This button is used to start playback.
- ㉘ **Pause [⏸] button (22)**  
This button is used to pause playback.
- ㉙ **Stop [■] button (22)**  
This button is used to stop playback.
- ㉚ **Previous [◀◀] button (25, 28)**  
This button is used to select the previous chapter or track. During playback it selects the beginning of the current chapter or track.
- ㉛ **Next [▶▶] button (25, 28)**  
This button is used to select the next chapter or track.
- ㉜ **STEP/SLOW [+ ] & [– ] buttons (29)**  
These buttons are used with the Frame-by-Frame Playback and Slow Motion Playback functions.
- ㉝ **DIMMER button (29)**  
This button is used to adjust the display brightness.
- ㉞ **PROGRESSIVE button (35)**  
This button is used to turn on and off the Progressive Scanning function. Progressive scanning can't be turned on or off during playback.

## Before Using the DV-CP702

### Installing the Remote Controller's Batteries

- 1** Open the battery compartment, as shown.

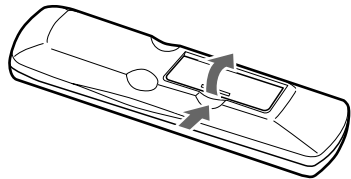

- 2** Insert the two supplied batteries (AA) in accordance with the polarity diagram inside the battery compartment.

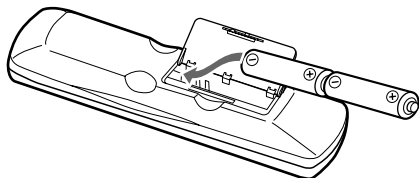

- 3** Close the battery compartment.

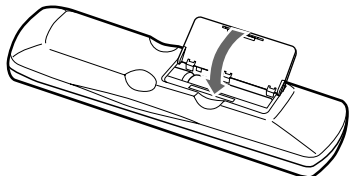

#### Notes:

- The supplied batteries should last for about six months, although this will vary with usage.
- If the remote controller doesn't work reliably, try replacing both batteries.
- Don't mix new and old batteries, or different types of batteries.
- If you intend not to use the remote controller for a long time, remove the batteries to prevent possible leakage and corrosion.
- Flat batteries should be removed as soon as possible to prevent possible leakage and corrosion.

### Using the Remote Controller

To use the remote controller, point it at the DV-CP702's remote control sensor, as shown below.

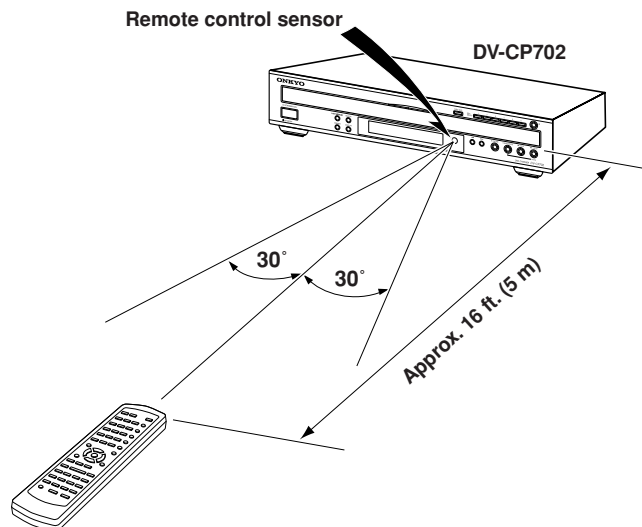

#### Notes:

- The remote controller may not work reliably if the DV-CP702 is subjected to bright light, such as direct sunlight or inverter-type fluorescent lights. Keep this in mind when installing the DV-CP702.
- If another remote controller of the same type is used in the same room, or the DV-CP702 is installed close to equipment that uses infrared rays, the remote controller may not work reliably.
- Don't put anything, such as a book, on the remote controller, because the buttons may be pressed inadvertently, thereby draining the batteries.
- The remote controller may not work reliably if the DV-CP702 is installed in a rack behind colored glass doors. Keep this in mind when installing the DV-CP702.
- The remote controller will not work if there's an obstacle between it and the DV-CP702's remote control sensor.

# Connecting the DV-CP702

This chapter explains how to connect the DV-CP702 to your other AV components.

## Before Making Any Connections

- Read the manuals supplied with your AV components.
- Don't connect the power cord until you've completed all audio and video connections.

### Optical Digital Inputs

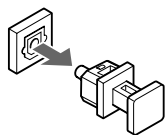

The DV-CP702's optical digital connector has a dust cap for keeping out dust and dirt when it's not in use. Remove the cap before inserting an optical digital plug. Push the plug in all the way to make a good connection. Keep the dust cap in a safe place for future use.

### RCA/phono AV Connection Color Coding

RCA/phono AV connections are usually color coded: red, white, and yellow. Use red plugs to connect right-channel audio inputs and outputs (typically labeled "R"). Use white plugs to connect left-channel audio inputs and outputs (typically labeled "L"). And use yellow plugs to connect composite video inputs and outputs.

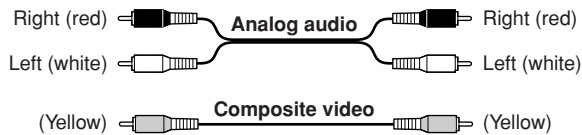

- Push the plugs in all the way to make a good connection.
- To prevent interference, keep audio and video cables away from power cords and speaker cables.

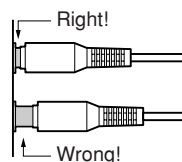

## AV Cables & Connectors

Video			
<b>Component video</b>			Component video separates the luminance (Y) and color difference signals (Pr, Pb), providing the best picture quality. (Some TV manufacturers label their component video inputs slightly differently.)
<b>S-Video</b>			S-Video provides better picture quality than composite video.
<b>Composite video</b>			Composite video can be found on virtually all TVs, VCRs, and other video equipment. Use only dedicated composite video cables.
Audio			
<b>Optical digital</b>			Optical digital audio connections with the optical digital audio output and a suitable AV receiver, you can enjoy DVD-Videos with surround sound.
<b>Coaxial digital</b>			Coaxial digital audio connections with the coaxial digital audio output and a suitable AV receiver, you can enjoy DVD-Videos with surround sound.
<b>Analog</b>			RCA/phono analog audio connectors can be found on virtually all AV components.



## Connecting the DV-CP702—Continued

### Connecting Your TV or Projector

This section explains how to connect the DV-CP702 to your TV or projector.

In this hookup example, the TV handles the audio and video. If your TV has a Dolby Pro Logic decoder built-in, you'll be able to enjoy DVDs and videos that bear the Dolby Surround logo.

To enjoy Dolby Digital or DTS (5.1-channel surround), you'll need a compatible decoder (see page 18).

The DV-CP702 has three types of video output: component video, S-Video, and composite video. Component video offers the best picture quality, so if your TV supports it, use a commercially available component video cable to connect the DV-CP702's COMPONENT video output to the component video inputs on your TV. If your TV supports progressive scanning, you must use component video in order to take advantage of that feature.

S-Video offers better picture quality than composite video, so if your TV supports it, use the supplied S-Video cable to connect the DV-CP702's S VIDEO output to an S-Video input on your TV. Failing that, use the supplied composite video cable to connect the DV-CP702's VIDEO output to a composite video input on your TV.

- 1** Turn off the DV-CP702 and your TV, and disconnect their power cords from the wall outlets.
- 2** Connect the DV-CP702 to your TV as shown.
- 3** When you've completed all connections, see "Powering Up & Setting Up the DV-CP702" on page 20.

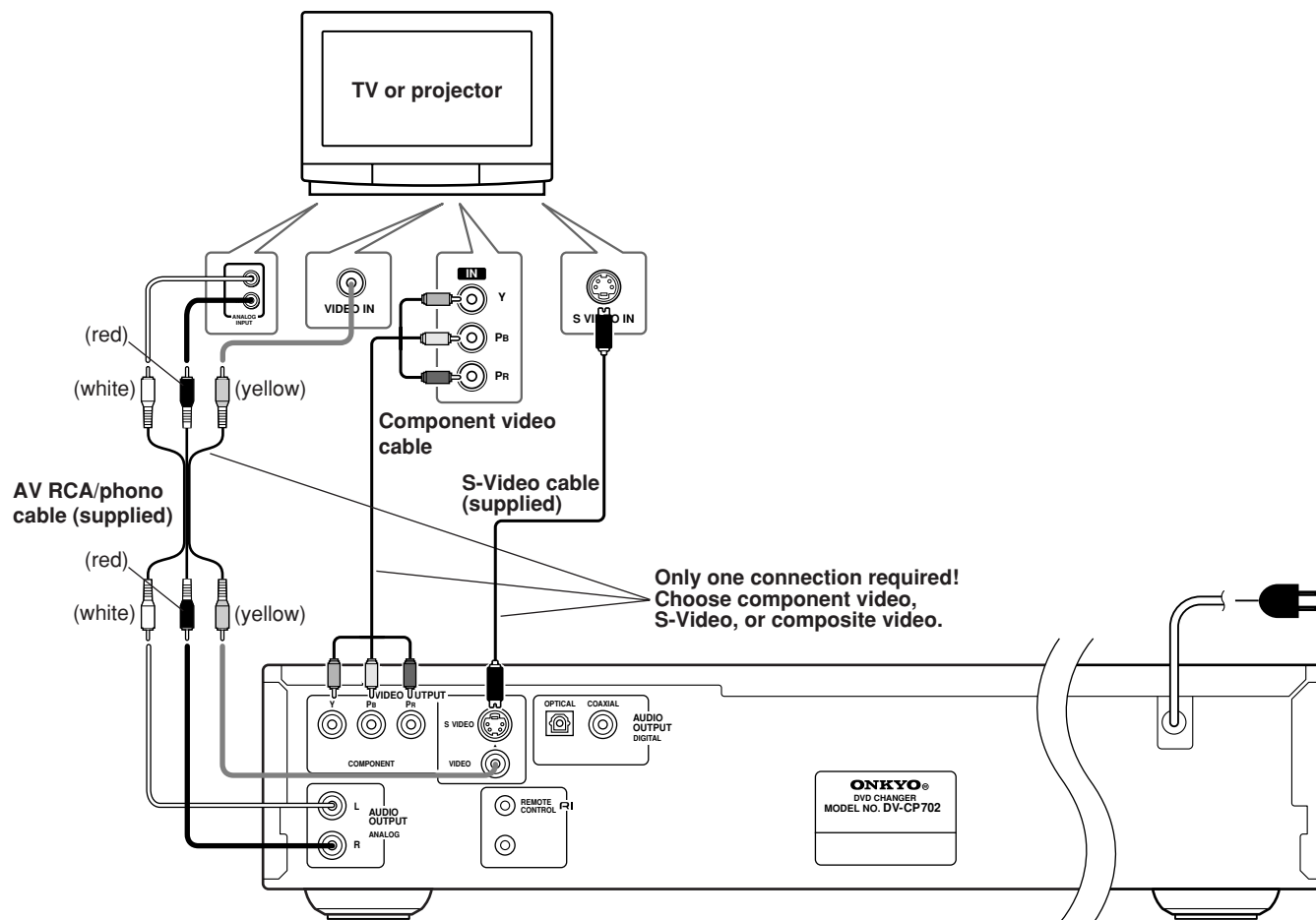

#### Notes

- Before making any connections, turn off the DV-CP702 and your TV and disconnect their power cords from the wall outlets.
- Also refer to the connection information supplied with your TV.
- Connect the DV-CP702's video outputs directly to your TV. Don't connect a VCR or other video equipment in between your DV-CP702 and TV. Doing so may result in

- picture distortion, because of the copy protection system used on DVD-Video discs.
- When you use the analog audio outputs, don't play DTS CDs or don't select DTS soundtracks on DVD-Video discs. Doing so will produce unpleasant digital noise, which may damage your equipment.

## Connecting the DV-CP702—Continued

### Connecting Your Hi-Fi Amp

This section explains how to connect the DV-CP702 to a stereo hi-fi amp or receiver for better sound quality than that of most TVs. This is ideal for playing your audio CDs and MP3/WMA discs in the DV-CP702. DVD-Video discs and Video CDs will sound better too. You can also enjoy Dolby Pro Logic, so long as your receiver supports it.

#### Analog Connection

Use an RCA/phono audio cable to connect the DV-CP702's ANALOG AUDIO OUTPUTS to a pair of analog audio inputs on your hi-fi amp or receiver, as shown.

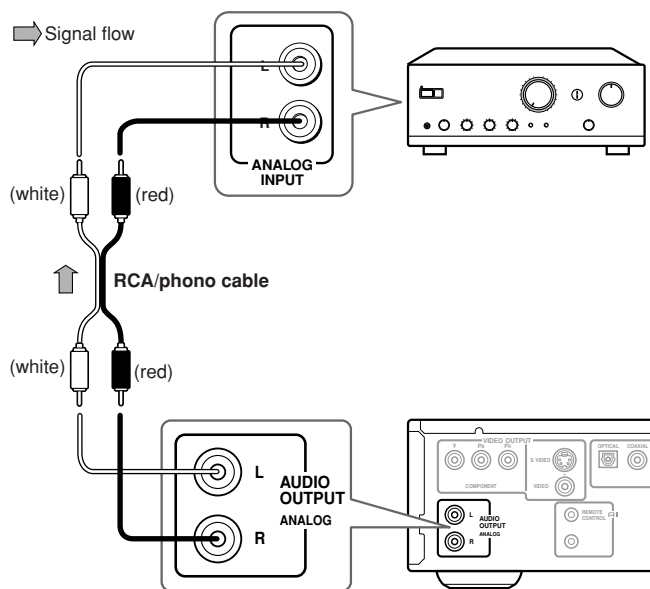

#### Notes:

- When you use the analog audio outputs, don't play DTS CDs or don't select DTS soundtracks on DVD-Video discs. Doing so will produce unpleasant digital noise, which may damage your equipment.

#### Digital Connection

Use an optical (or coaxial) digital audio cable to connect the DV-CP702's OPTICAL (or COAXIAL) DIGITAL AUDIO OUTPUT to an optical (or coaxial) input on your hi-fi amp or receiver, as shown.

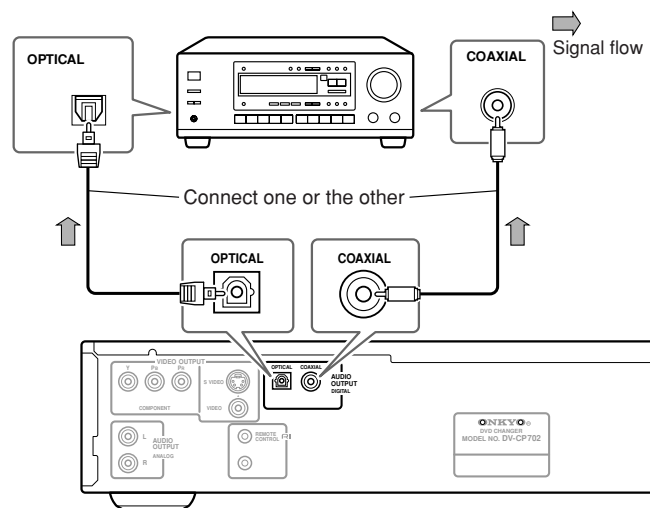

#### Notes:

- Be sure to set the Digital Out->Dolby Digital setting to "Dolby Digital>PCM" (see page 41). Otherwise an unpleasant digital noise may be heard, which may damage your equipment.
- Never connect the DV-CP702 to the AC-3RF input on a Dolby Digital receiver. The AC-3RF format is not supported by the DV-CP702.

### Connecting for Dolby Digital or DTS

To enjoy Dolby Digital or DTS surround sound, you need to connect one of the DV-CP702 digital audio outputs to the digital input on a Dolby Digital or DTS decoder or an AV receiver with built-in decoders.

This hookup example will also allow you to enjoy Dolby Pro Logic, so long as your decoder or AV receiver supports it.

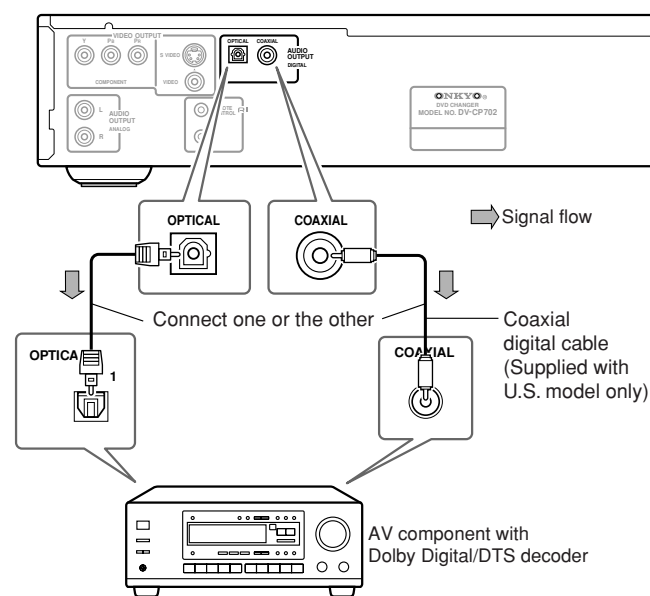

#### Notes:

- Make sure that the Digital Out->Dolby Digital setting to "Dolby Digital" (see page 41). Otherwise you won't get surround sound.
- Also refer to the connection information supplied with your AV receiver or decoder.
- When playing Dolby Digital or DTS source material, be sure to select Dolby Digital or DTS decoding, respectively, on your AV receiver or decoder. See the relevant manuals.
- You can experience Dolby Digital only with DVDs that bear the Dolby Digital logo. Likewise, you can experience DTS only with DVDs or CDs that bear the DTS logo.

# Connecting **RI**-compatible AV Components

With **RI** (Remote Interactive) you can control your DV-CP702 and other **RI**-compatible Onkyo AV components together. With some Onkyo AV receivers you can use one remote controller to control all your Onkyo components, and use the following special **RI** functions:

■ **Auto Power On**

If your DV-CP702 is connected to an **RI**-compatible Onkyo AV receiver, when you turn on the DV-CP702, the AV receiver will turn on and select the DV-CP702 as the input source.

■ **Auto Source Select**

If your DV-CP702 is connected to an **RI**-compatible Onkyo AV receiver, when you start playback on the DV-CP702, the AV receiver will select the DV-CP702 as the input source.

■ **Auto Power Off**

When you set any **RI**-compatible Onkyo AV receiver to Standby, all other AV components connected via **RI** enter Standby as well.

■ **Dimmer**

When you dim the display brightness on an **RI**-compatible Onkyo AV component, the displays on all other AV components connected via **RI** are dimmed as well.

See the manuals supplied with your other **RI**-compatible AV components for more information.

## Connection Diagram

To use the **RI** functions, you need to connect one of the DV-CP702's **RI** connectors to an **RI** connector on another AV component by using an **RI** cable. An **RI** cable is supplied with all **RI**-compatible Onkyo CD players, DVD players, and cassette recorders.

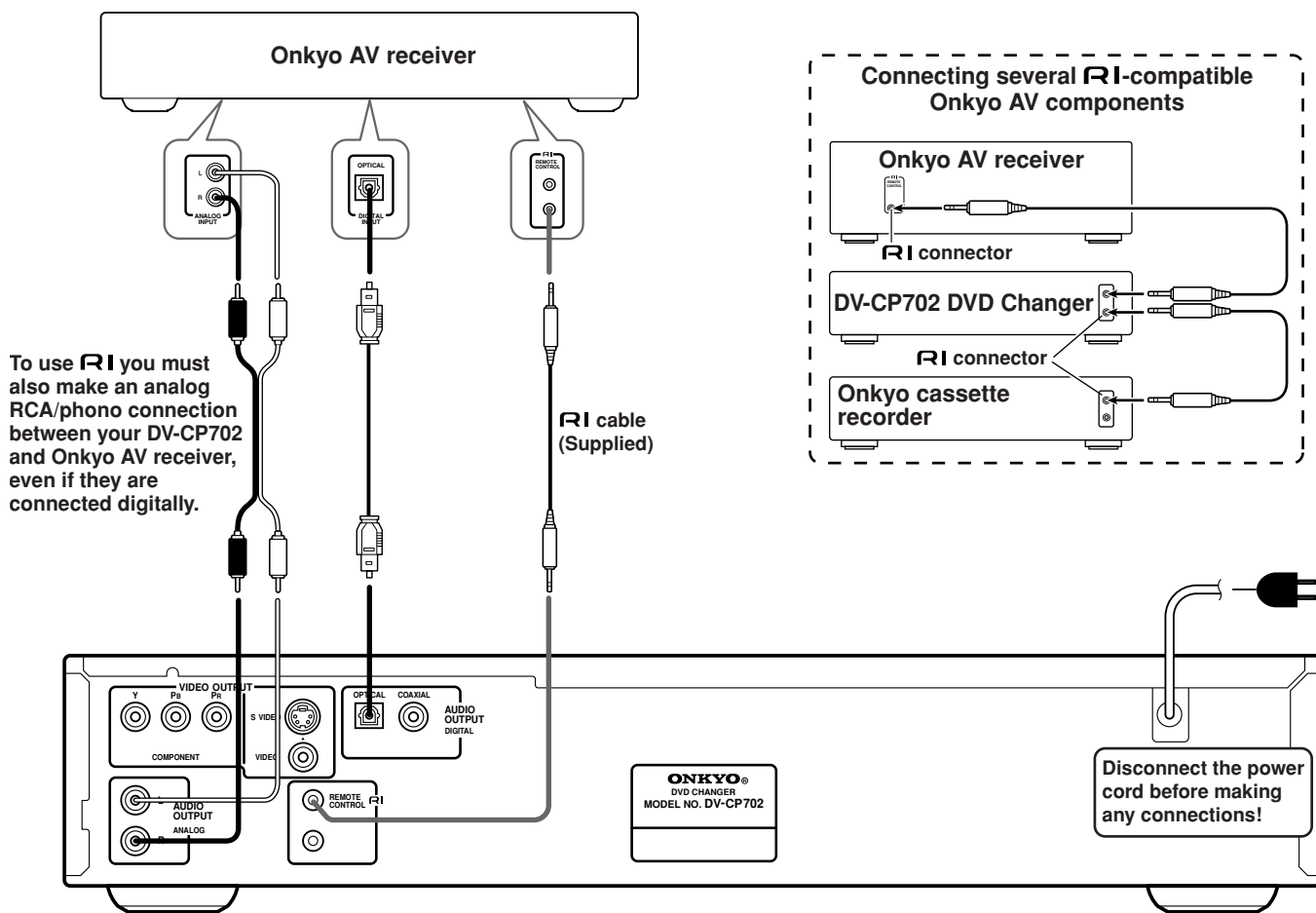

**Notes:**

- Push the plugs in all the way to make a good connection.
- Use only **RI** cables for **RI** connections.
- **To use RI you must also make an analog RCA/phono connection between your DV-CP702 and Onkyo AV receiver, even if they are connected digitally.**

- The DV-CP702 has two **RI** connectors. You can connect either one to your Onkyo AV receiver. The other connector is for connecting additional **RI**-compatible components.
- Connect the DV-CP702's **RI** connector to only Onkyo AV components. Connecting to other manufacturer's AV components may cause them to malfunction.
- Some Onkyo **RI**-compatible AV components may not support the special functions described above.

# Powering Up & Setting Up the DV-CP702

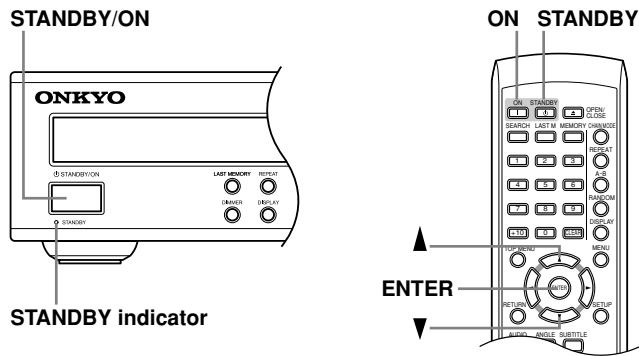

## Powering Up the DV-CP702

Before connecting the power cord, connect all your AV components (see page 16 to page 19).

Don't forget to turn on your TV or projector and select the video input to which the DV-CP702 is connected.

If you're using a hi-fi amp, AV receiver, or surround sound decoder for audio playback, turn that on as well and select the audio input to which the DV-CP702 is connected.

- 1** **Connect the power cord to a suitable wall outlet.**  
The DV-CP702 enters Standby mode, and the STANDBY indicator comes on.
- 2** **To turn on the DV-CP702, press the [STANDBY/ON] button (or the remote controller's [ON] button).**  
The DV-CP702 comes on, the display lights up, and the STANDBY indicator goes off.

**Remote controller**  
To turn off the DV-CP702, press the [STANDBY/ON] button (or the remote controller's [STANDBY] button). The DV-CP702 enters Standby mode and the STANDBY indicator comes on.

## First Time Setup

The very first time you turn on your DV-CP702, the Initial Setup menu appears onscreen, as shown.

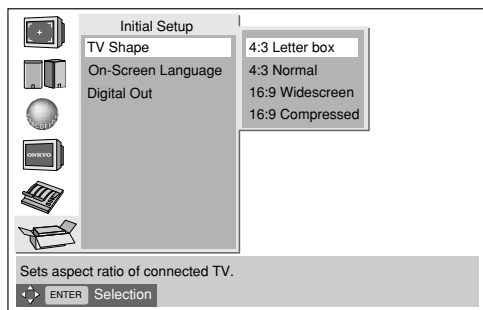

Here you need to specify the size of your TV (standard 4:3 or widescreen 16:9), select a language for the onscreen setup menus, and configure the digital audio output. You can change these settings later by using the onscreen setup menus (see page 38).

- 1** **Remote controller**  
**Use the remote controller's Up/Down [▲]/[▼] buttons to select a TV shape, and then press [ENTER].**  
See page 39 for more information on the TV Shape options.  
The On-Screen Language menu appears.
- 2** **Remote controller**  
**Select a language, and then press [ENTER].**  
See page 41 for more information on the language options.  
The Digital Out->Dolby Digital menu appears.
- 3** **Remote controller**  
**Select a Dolby Digital option, and then press [ENTER].**  
See page 41 for more information on the digital audio output options.  
The Digital Out->Linear PCM Out menu appears.
- 4** **Remote controller**  
**Select a Linear PCM Out option, and then press [ENTER].**  
The Digital Out->MPEG Out menu appears.
- 5** **Remote controller**  
**Select an MPEG Out option, and then press [ENTER].**  
The Digital Out->Digital Out menu appears.
- 6** **Remote controller**  
**Select a Digital Out option, and then press [ENTER].**  
The Initial Setup menu closes.

Your DV-CP702 is now ready for use. See page 21 for information on loading discs, and page 22 for information on selecting and playing discs.

### Notes:

- You can change the language of the onscreen setup menus, and your preferred languages for DVD menus, foreign language soundtracks, and subtitles individually on the Language page of the onscreen setup menus (see page 41).
- Not all DVD-Video discs have multi-language menus, foreign language soundtracks, and subtitles. In such cases, the disc's default language is used.

# Basic Playback

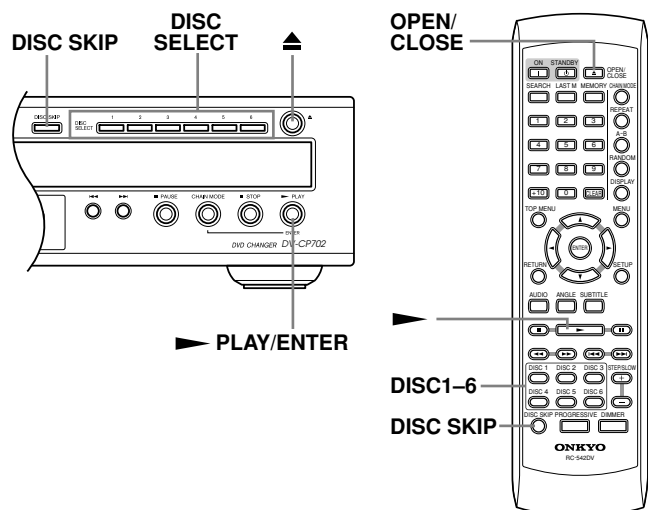







## Notes:

- You can load up to six discs. You don't have to load all six discs every time.
- When the disc tray is closed, all of the disc indicators appear until the DV-CP702 has checked each bay for the presence of a disc. If a bay is found to have no disc, the corresponding indicator disappears.
- The disc tray can be opened and closed even while the DV-CP702 is in Standby mode, so you don't have to turn it on to load or remove your discs. (The disc tray may take several seconds to open.)
- The DV-CP702 supports 8 cm and 12 cm discs. To avoid damaging your discs or DV-CP702, always place discs in the center of the disc bays.
- Only load discs that are supported by the DV-CP702 (see page 7). Don't load cartridge-type discs.
- To avoid personal injury, keep your hands away from the disc tray as it closes.
- Always use the OPEN/CLOSE [▲] button to open and close the disc tray. Never push the disc tray, and don't touch it, or obstruct it while it's opening or closing. Don't press down on the disc tray while it's open, and don't load anything other than supported discs. Doing so may damage your discs or DV-CP702.

## Loading & Removing Discs









This section explains how to load and remove discs.

<b>1</b>	 Remote controller  OPEN/CLOSE	<p><b>Press the OPEN/CLOSE [▲] button.</b></p> <p>The disc tray opens and the six disc number indicators appear on the display. A circle appears around the number of the disc bay on the right.</p>
<b>2</b>	<p><b>Place a disc, label side up, into each bay.</b></p>	
<b>3</b>	 Remote controller DISC SKIP 	<p><b>Press the [DISC SKIP] button to access the other disc bays.</b></p> <p>The disc tray turns counterclockwise two bays at a time.</p>
<b>4</b>	 Remote controller  OPEN/CLOSE	<p><b>When you've finished, press the OPEN/CLOSE [▲] button again.</b></p> <p>The disc tray closes.</p> <p>See page 22 for information on selecting and playing discs.</p> <p><b>Tip:</b> If you press the Play [▶] button, the disc tray will close and playback of the disc in the right bay will start automatically. If there is no disc in that bay, the DV-CP702 will check the other bays and play the first disc it finds.</p> <p><b>Tip:</b> If you press one of the DISC SELECT 1-6 buttons, the disc tray will close and playback of the selected disc will start automatically.</p>

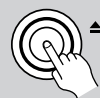
## Loading Discs During Playback

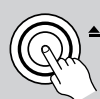

This section explains how to load and remove discs without stopping playback.

<b>1</b>	 Remote controller  OPEN/CLOSE	<p><b>Press the OPEN/CLOSE [▲] button.</b></p> <p>The disc tray opens.</p> <p>The disc that's currently playing remains inside the DV-CP702 and its disc bay is empty and won't come to the front. To remove this disc you must stop playback before pressing the OPEN/CLOSE [▲] button.</p>
<b>2</b>	 Remote controller DISC SKIP 	<p><b>Load or remove discs as required, and press the [DISC SKIP] button to access the other disc bays.</b></p> <p>The disc numbers appear onscreen. The number of the disc bay on the right is highlighted.</p>
<b>3</b>	 Remote controller  OPEN/CLOSE	<p><b>When you've finished, press the OPEN/CLOSE [▲] button again.</b></p> <p>The disc tray closes.</p> <p>Playback of the current disc continues uninterrupted until you either stop playback or select another disc.</p> <p><b>Tip:</b> If you press one of the DISC SELECT 1-6 buttons, the disc tray will close, playback of the current disc will stop, and playback of the newly selected disc will start automatically.</p>

## Basic Playback—Continued

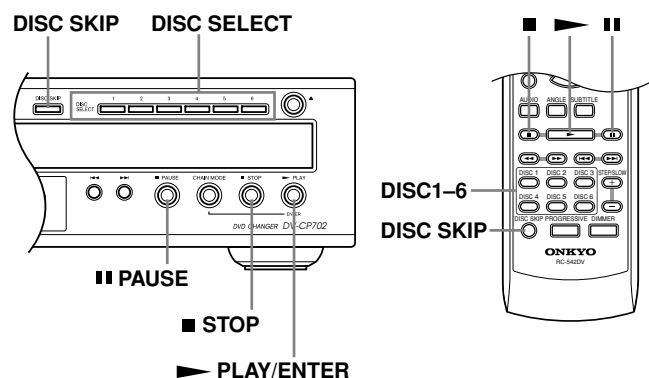

### Selecting Discs

DVD VCD CD MP3 WMA JPEG

The section explains how to select loaded discs.

**Use the DISC SELECT buttons to select loaded discs.**

On the remote controller these buttons are labelled [DISC 1], [DISC 2], and so on.

On the display, the number of the current disc has a circle around it.

What happens next depends on the type of disc you selected, as follows:

**DVD-Video:** Typically a menu appears onscreen. See page 24.

**Video CD:** Playback starts automatically.

**Audio CD:** Playback starts automatically.

**MP3/WMA/JPEG:** The Disc Navigator appears onscreen. See page 26.

**JPEG-only CD:** With some JPEG CDs, picture thumbnails appear onscreen. See page 30.

**Remote controller**

#### Notes:

- The type of disc currently selected is shown on the display: DVD, VCD, or CD (see page 11).
- You can select discs while the DV-CP702 is stopped or during playback.
- You can use the [DISC SKIP] button to skip the current disc and start the next disc. If disc #6 is the current disc, disc #1 will be selected next.

### Starting, Pausing & Stopping Playback

DVD VCD CD MP3 WMA

This section explains how to start, pause, and stop playback.

#### Start



**To start playback, press the Play [▶] button.**

Playback starts and the Play ▶ indicator appears on the display.

If the disc is a DVD-Video or Video CD with PBC (Playback Control), you may need to start playback from a menu (see page 24).

The front panel Play [▶] button performs play and enter functions. The remote controller has separate Play [▶] and [ENTER] buttons.

#### Pause



**To pause playback, press the Pause [⏸] button.**

Playback pauses and the Pause ⏸ indicator appears on the display.

To resume playback, press the Play [▶] button.

Playback resumes and the Pause ⏸ indicator disappears.

#### Stop



**To stop playback, press the Stop [■] button.**

Playback stops and the Play ▶ indicator disappears.

#### Notes:

- During playback, you can select chapters or tracks by using the Next [▶▶] and Previous [◀◀] buttons.
- When you stop playback of a DVD-Video disc or Video CD, the DV-CP702 remembers the point at which playback was stopped and “Resume” appears onscreen for a few seconds. To resume playback from that point, press the Play [▶] button. To cancel the Resume function, press the Stop [■] button again. The Resume function is reset when another disc is selected.
- With the Last Memory function you can resume playback from a specific point even if the disc has been removed (see page 36).
- Do not move the DV-CP702 or subject it to vibration during playback. Doing so may damage your discs or DV-CP702.
- You can improve the picture quality of paused playback with the Pause/Still setting (see page 43).

## Basic Playback—Continued

---

- Prolonged display of the same picture or menu may cause irreparable damage to your TV screen called *screen burn-in*. To prevent this, don't keep playback paused for too long and always press the Stop [■] button when you've finished playing a DVD-Video disc or Video CD. Your DV-CP702 features a screen saver to protect your TV from the effects of burn-in (see page 43).
- With some DVD-Video discs, you may experience picture noise that is not normally visible with regular TV broadcasts. This is usually because DVD-Video disc uses a lot of high-resolution video data. The amount of noise, if any, will depend on your particular TV and the problem can sometimes be alleviated by turning down your TV's sharpness control.

## Basic Playback—Continued

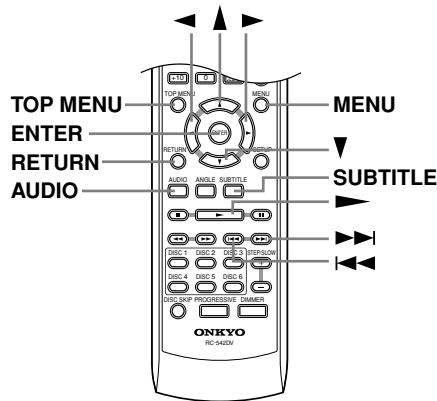
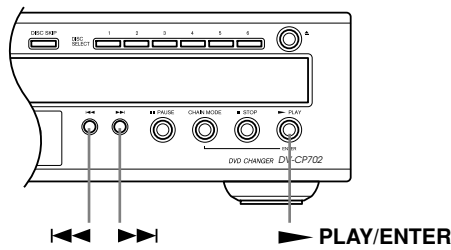

### Navigating Disc Menus



DVD-Video discs usually have an onscreen menu from which you can select titles, chapters, and other options, including foreign language soundtracks, subtitles, and audio formats (e.g., Dolby Digital or DTS). Video CDs that support PBC (Playback Control) may also have an onscreen menu (see page 8).

#### 1 Load and select a DVD-Video disc or Video CD.

See page 21 and page 22.

With DVD-Video discs, a menu usually appears automatically. If it doesn't, try pressing the [TOP MENU] button.

With some PBC Video CDs, you may have to press the Play [▶] button to display the menu.

#### 2

Remote controller

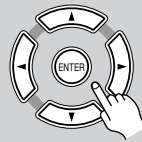

Use the remote controller's navigation [▲], [▼], [◀], [▶] buttons to select items on the menu, and use the [ENTER] button to confirm your selection.

If you select a playback option (e.g., subtitles), another menu of options will typically appear, in which case you use the remote controller's navigation buttons to select items and the [ENTER] button to confirm your choice.

With PBC Video CDs, you have to enter a number to select a menu item, which you can do by using the remote controller's number buttons. If the Video CD's menu has several pages, use the Next [▶▶] and Previous [◀◀] buttons to select them. During playback, you can display the menu by pressing the [RETURN] button.

#### Notes:

- Not all DVD-Video discs and PBC Video CDs have menus.
- Menu operation varies from disc-to-disc. See the disc's sleeve notes for details.
- On some DVD-Video discs, options such as foreign language soundtracks, subtitles, and audio formats appear on a separate menu called the *disc menu*, and titles and chapters appear on what's called the *title menu*. To display the disc menu, press the [MENU] button. If no menu appears, press the [TOP MENU] button.
- With DVD-Video discs, foreign language soundtracks and audio formats can usually be selected during playback by using the remote controller's [AUDIO] button (see page 35). Similarly, subtitles can be selected by using the remote controller's [SUBTITLE] button (see page 35).
- You must turn on PBC in order to use the menus on a PBC Video CD (see page 43).
- If PBC is off (see page 43), or your Video CD doesn't support it, you can use the Next [▶▶] and Previous [◀◀] buttons, or the remote controller's number buttons to select tracks on a Video CD.
- PBC menus can be hidden or displayed while playback is stopped by pressing the [TOP MENU] button.



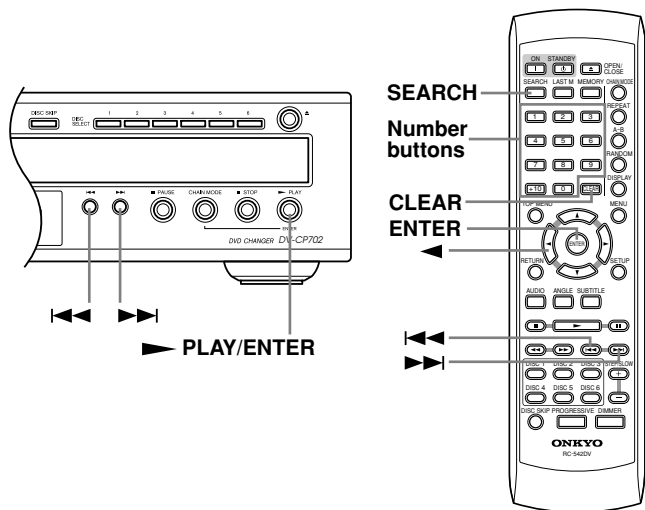

## Basic Playback—Continued



### Selecting Titles & Chapters by Number

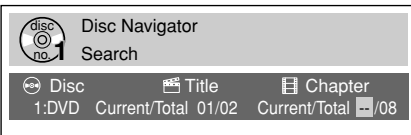

This section explains how to select chapters, titles, and discs by number.

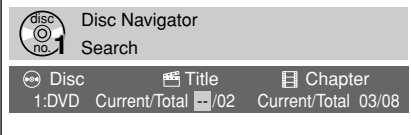
<b>1</b>	<p><b>Load and select a DVD-Video disc.</b> See page 21 and page 22.</p>
<b>2</b>	<p><b>Press the [SEARCH] button.</b> The Disc Navigator Search window appears onscreen, as shown.</p> <div style="border: 1px solid black; padding: 5px; margin: 10px 0;">  <div style="display: flex; justify-content: space-between; align-items: center;"> <div style="text-align: center;">  </div> </div> </div> <p>With some DVD-Video discs you can select only titles, and the Chapter Current/Total information is not displayed. Some discs won't allow you to select titles.</p>
<b>3</b>	<p><b>If you want to select a title, use the [◀] button to select the title number.</b></p> <div style="border: 1px solid black; padding: 5px; margin: 10px 0;">  <div style="display: flex; justify-content: space-between; align-items: center;"> <div style="text-align: center;">  </div> </div> </div>

### 4

Remote controller



**Use the number buttons to specify a chapter or title.**

To enter, for example, “2,” press the [2] button.

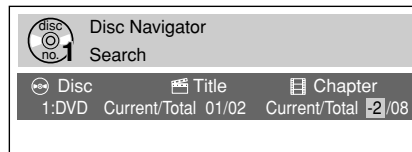

To enter, for example, “12,” press the [1] or [+10] button followed by the [2] button.

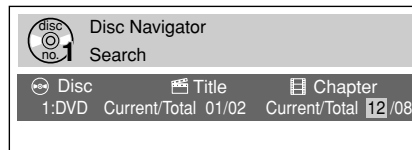

To clear the number, press the [CLEAR] button.

### 5

▶ PLAY



Remote controller

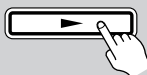

**Press the Play [▶] or [ENTER] button to start playback of the specified chapter or title.**

During playback, you can select other chapters by using the Next [▶▶] and Previous [◀◀] buttons.

### Notes:

- You can also select chapters by using the number buttons, without opening the Disc Navigator Search window.
- If the current DVD-Video disc contains only one title, you won't be able to select other titles. Similarly, if it contains no chapters, you won't be able to select chapters.
- DVD-Video discs usually have onscreen menus for selecting titles and chapters (see page 24).
- With some discs you may not be able to select titles and chapters as described here.

## Basic Playback—Continued

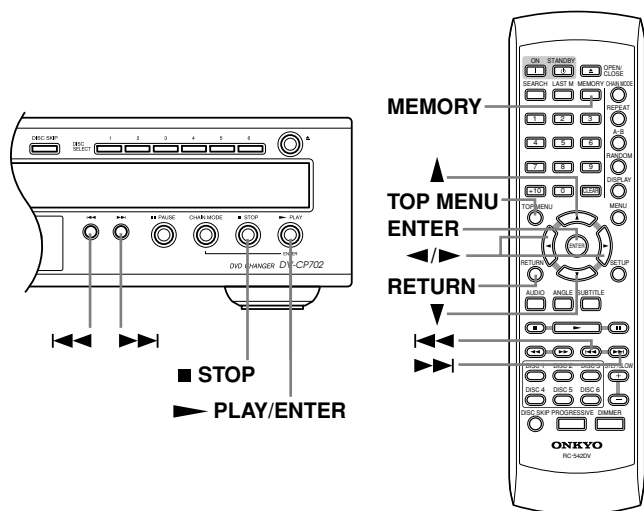

### Using the Disc Navigator

MP3 WMA JPEG

With the Disc Navigator you can select MP3, WMA, and JPEG files.

1

**Load and select a disc containing MP3, WMA, or JPEG files.**

See page 21 and page 22.

The Disc Navigator appears, as shown.

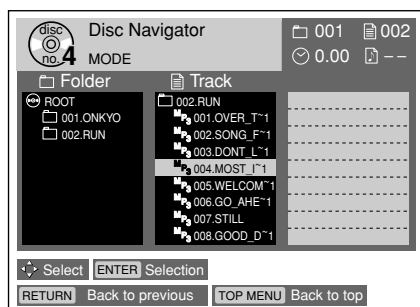

The number of the currently selected disc is shown on the disc icon. The Folder column lists the folders. The Track column lists the tracks in the open folder.

The file information displayed depends on the type of file selected, as follows:

**MP3/WMA:** Title, Artist Name, and Album Name.

**JPEG:** Thumbnail-size preview, File Size and Date Created.

During playback, the following information is displayed in the upper-right corner: folder number, file number, and elapsed time. During memory playback, the current step number is displayed as well.

2

Remote controller

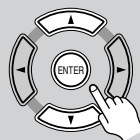

**To open a folder, use the remote controller's Up/Down [▲]/[▼] buttons to select it, and then press [ENTER].**

Use the Up/Down [▲]/[▼] buttons to select tracks in the open folder.

3

Remote controller



**To close a folder (i.e., move back up the directory tree), press the [RETURN] button.**

To get back to the root level, press the [TOP MENU] button.

4



Remote controller

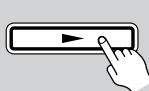

**To play a track, select it, and then press the Play [▶] button (or the [ENTER] button).**

When all the tracks in that folder have been played, tracks in the next folder are played.

You can select the next or previous track during playback by using the Next [▶▶] and Previous [◀◀] buttons.

If the disc contains MP3/WMA files and JPEG files, they are played/displayed in order. JPEG files will be displayed in a slideshow. Press the [MENU] button to display the first nine pictures at thumbnail-size (see page 30). Depending on the disc, the first nine pictures may be displayed automatically.

5

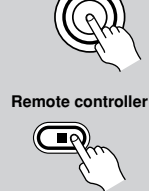

**Press the Stop [■] button to stop playback.**

#### Notes:





- If the selected JPEG file's resolution is 640 x 480 pixels, a thumbnail-size preview will be shown. If the resolution exceeds 640 x 480, a preview will only be shown if the file contains thumbnail image data.
- If the TV shape is set to "16:9 Compressed," no thumbnail-size preview will be displayed by the Disc Navigator.
- You can use the Random Playback function to play a random selection of MP3/WMA files (page 32).
- During random playback, the remote controller's navigation [▲], [▼], [◀], [▶] buttons cannot be used with the Disc Navigator.
- You can use the Disc Navigator to create a playlist of MP3/WMA files for memory playback.

## Basic Playback—Continued

### Memory Playback in the Disc Navigator

MP3 WMA JPEG

You can compile a playlist of tracks and folders in the Disc Navigator as follows.

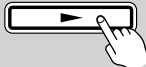
<p><b>1</b></p> <p>Remote controller</p> 	<p><b>With the Disc Navigator open, press the [MEMORY] button.</b></p> <p>The playlist appears in place of the file information.</p>
<p><b>2</b></p> <p>Remote controller</p>  	<p><b>To add a track to the playlist, use the [▲], [▼], [◀], [▶] buttons to select it in the track column, and then press the [ENTER] button.</b></p> <p>To add a folder to the playlist, you need to select the folder at the top of the track column. “ALL” will be displayed in the playlist.</p> <p>Press the [MEMORY] button again to open the Memory Play Setup window, on which you can add titles, chapters, tracks, and folders from any disc (see page 33).</p>
<p><b>3</b></p>  <p>Remote controller</p> 	<p><b>To start memory playback, press the Play [▶] button.</b></p>

## Basic Playback—Continued

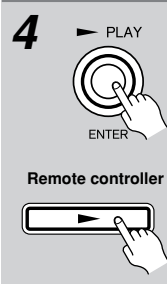
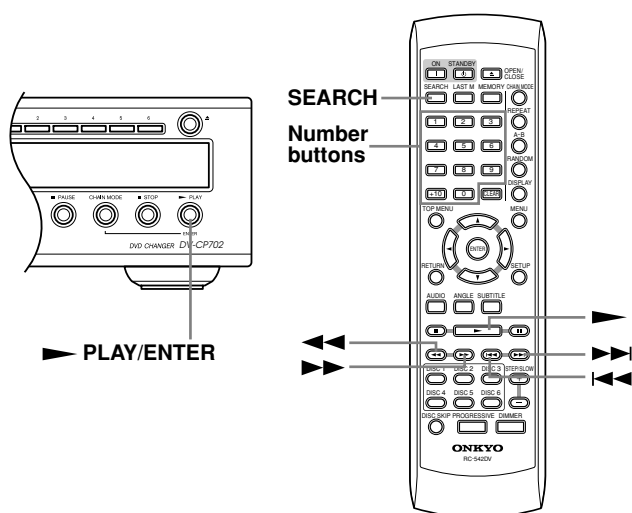

**4** Press the Play [▶] button to start playback of the specified track.

You can also select tracks while the DV-CP702 is during playback by using the Next [▶▶] and Previous [◀◀] buttons.

### Notes:

- You can also select tracks by using the number buttons without opening the Disc Navigator Search window.
- If PBC is on (see page 43), and your Video CD supports PBC (Playback Control), you may be able to select tracks from an onscreen menu (see page 24).
- With PBC Video CDs you can also use the number buttons to select tracks from a menu.
- You can't use the [SEARCH] button during random playback.

## Selecting Tracks by Number

VCD CD MP3 WMA

This section explains how to select tracks by number.

<b>1</b>	<p><b>Load and select a Video CD, audio CD, or MP3/WMA disc.</b></p> <p>See page 21 and page 22.</p>
<b>2</b>	<p><b>Press the [SEARCH] button during playback.</b></p> <p>The Disc Navigator Search window appears onscreen, as shown.</p>
<b>3</b>	<p><b>Use the number buttons to enter a track number.</b></p> <p>To enter, for example, "5," press the [5] button.</p> <p>To enter, for example, "18," press the [1] or [+10] button followed by the [8] button.</p>

## Fast Forward & Reverse

DVD VCD CD MP3 WMA

The section explains how to fast forward and reverse.

<b>Fast forward</b>	<p><b>During playback, press the Fast Forward [▶▶] button to start fast forward.</b></p> <p>Playback fast forwards and "Fast Forward 1" appears onscreen.</p> <p>To change the fast-forward speed, press the Fast Forward [▶▶] button repeatedly to cycle through the speeds: Fast Forward 1, Fast Forward 2, and so on.</p> <p><b>To resume normal playback, press the Play [▶] button.</b></p>
<b>Fast reverse</b>	<p><b>During playback, press the Fast Reverse [◀◀] button to start fast reverse.</b></p> <p>Playback reverses and "Fast Reverse 1" appears onscreen.</p> <p>To change the fast-reverse speed, press the Fast Reverse [◀◀] button repeatedly to cycle through the speeds: Fast Reverse 1, Fast Reverse 2, and so on.</p> <p><b>To resume normal playback, press the Play [▶] button.</b></p>

### Notes:

- There are five fast forward and fast reverse speeds for DVD-Video discs and three for Video CDs, audio CDs, and MP3/WMA discs.
- No sound is output during fast forward or fast reverse of a DVD-Video disc or Video CD.
- Sound is output intermittently during fast forward or fast reverse of an audio CD or MP3/WMA disc.
- Fast reverse playback is not possible with WMA tracks.

## Basic Playback—Continued

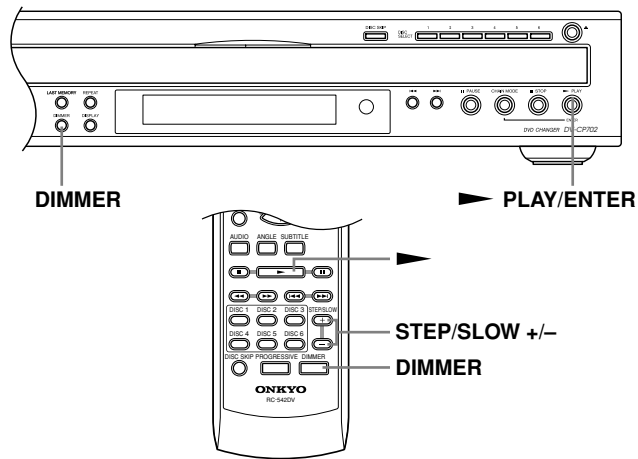

### Frame-by-Frame Playback

DVD VCD

With the Frame-by-Frame Playback function you can view individual frames one at a time either forward or backward.

<p><b>Forward frame-by-frame</b></p> <p>Remote controller</p>	<p><b>While paused, press the STEP/SLOW [+] button.</b></p> <p>Press the STEP/SLOW [+] button repeatedly to view subsequent frames.</p>
<p><b>Backward frame-by-frame</b></p> <p>Remote controller</p>	<p><b>While paused, press the STEP/SLOW [-] button.</b></p> <p>Press the STEP/SLOW [-] button repeatedly to view previous frames.</p>
<p><b>Resume playback</b></p> <p>Remote controller</p>	<p><b>To resume normal playback, press the Play [▶] button.</b></p>

**Notes:**

- Backward frame-by-frame playback is not possible with Video CDs.
- You can improve the picture quality of frame-by-frame playback with the Pause/Still setting (see page 43).
- With some discs, the picture may shake when using backward frame-by-frame playback.
- No sound is output during frame-by-frame playback.
- Prolonged display of the same picture or menu may cause irreparable damage to your TV screen called *screen burn-in*. To prevent this, don't display the same frame for too long. Your DV-CP702 features a screen saver to protect your TV from the effects of burn-in (page 43).

### Slow-motion Playback

DVD VCD

With the Slow-motion Playback function you can watch a scene slowly either forward or backward.

<p><b>Forward slow motion</b></p> <p>Remote controller</p>	<p><b>During playback, press the STEP/SLOW [+] button.</b></p> <p>Forward slow-motion playback starts and “Slow 1” appears onscreen.</p> <p>To change the slow-motion speed, press the STEP/SLOW [+] button repeatedly to cycle through the speeds: Slow 1, Slow 2, and so on.</p>
<p><b>Backward slow motion</b></p> <p>Remote controller</p>	<p><b>During playback, press the STEP/SLOW [-] button.</b></p> <p>Backward slow-motion playback starts and “Reverse Slow 1” appears onscreen.</p> <p>To change the slow-motion speed, press the STEP/SLOW [-] button repeatedly to cycle through the speeds: Reverse Slow 1, Reverse Slow 2, and so on.</p>
<p><b>Resume playback</b></p> <p>Remote controller</p>	<p><b>To resume normal playback, press the Play [▶] button.</b></p>

**Notes:**

- There are four slow motion speeds for DVD-Video discs and three for Video CDs.
- Backward slow-motion playback is not possible with Video CDs.
- No sound is output during slow-motion playback.

### Adjusting the Display Brightness

DVD VCD CD MP3 WMA JPEG

You can adjust the brightness of the display as follows.

<p><b>1</b></p> <p>DIMMER</p>	<p><b>Press the [DIMMER] button repeatedly to cycle through the following options: dim, dimmer, disc tray light off, normal brightness.</b></p>
-------------------------------	---

**Notes:**

- When the display brightness on another Onkyo AV component connected via **RI** is changed, the “disc tray light off” option might not work.
- Even if you selected the “disc tray light off” option, the disc tray light will come on when the disc tray is opened.

## Basic Playback—Continued

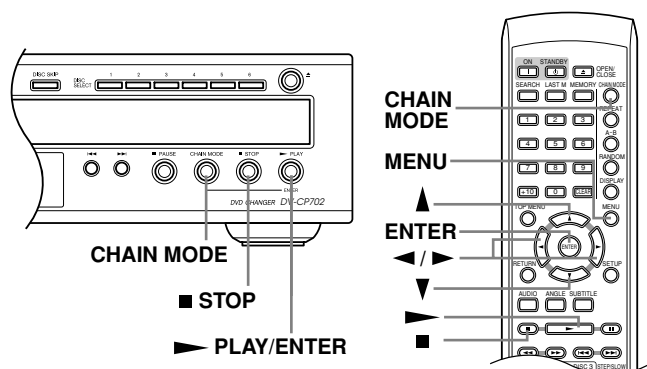

### Using JPEG CDs

The DV-CP702 supports JPEG CDs, so you can view your photos on TV either individually or as a slideshow.

**1**

#### Load and select a CD containing JPEG pictures.

See “Using the Disc Navigator” on page 26, and follow the procedure up to step 4 so that the first nine pictures are displayed at thumbnail-size before continuing with this procedure.

With some JPEG discs, the first nine pictures automatically appear onscreen at thumbnail-size when the disc is selected.

Use the Next [▶▶] and Previous [◀◀] buttons to display the next or previous folder or page.

Use the [◀], [▶], [▲], [▼] buttons to select a picture, and then press the Play [▶] or [ENTER] button to start the slideshow.

If this folder icon is displayed in the upper-left corner, selecting it and pressing [ENTER] will open the Disc Navigator window.

**2**

#### You can use the following functions during the slideshow:

To display the next or previous picture, use the Next [▶▶] and Previous [◀◀] buttons.

To turn a picture upside down, use the Up/Down [▲]/[▼] buttons (not while zoomed in).

To rotate a picture clockwise or counter-clockwise, use the Left/Right [◀]/[▶] buttons (not while zoomed in).

To pause the slideshow, press the ■■ button. Press the Play [▶] button to resume.

To zoom in or out, use the Fast Forward [▶▶] and Fast Reverse [◀◀] buttons. Use the Left/Right [◀]/[▶] and Up/Down [▲]/[▼] buttons to move around the picture while zoomed in. The slideshow pauses while zoomed in. To cancel the zoom, press the Play [▶] button.

**3**

■ STOP



Remote controller



MENU



To stop the slideshow, press the [STOP] or [MENU] button.

Depending on the type of JPEG disc, either the first nine pictures appear in thumbnail-size or the Disc Navigator window appears.

The slideshow stops automatically when all pictures have been displayed.

### Using Chain Mode

DVD VCD CD MP3 WMA

With the Chain mode function you can consecutively play all discs, all DVD-Video discs and Video CDs, or all audio CDs and MP3/WMA discs as if they were one big disc.

**1**

CHAIN MODE



Remote controller



Press the [CHAIN MODE] button repeatedly to select CD, DVD, or ALL.

The CHAIN MODE indicator flashes appear on the display.

**ALL:** All discs are played consecutively.

**DVD:** All DVD-Video discs and Video CDs are played consecutively.

**CD:** All CDs (audio/MP3/WMA) are played consecutively.

**2**

▶ PLAY



Remote controller



While the CHAIN MODE indicator is flashing, press the Play [▶] or [ENTER] button to start Chain mode playback.

The Chain mode function will be cancelled if you do not start playback within five seconds of pressing the [CHAIN MODE] button.

#### Notes:

- With the DVD and All Chain modes, Video CD PBC menus are ignored.
- JPEG files are skipped during Chain mode playback.
- With the DVD and All Chain modes, DVD-Video menus are ignored and titles are played automatically. This may not work with some discs.
- You can't use the repeat functions with Chain mode playback.

# Advanced Playback

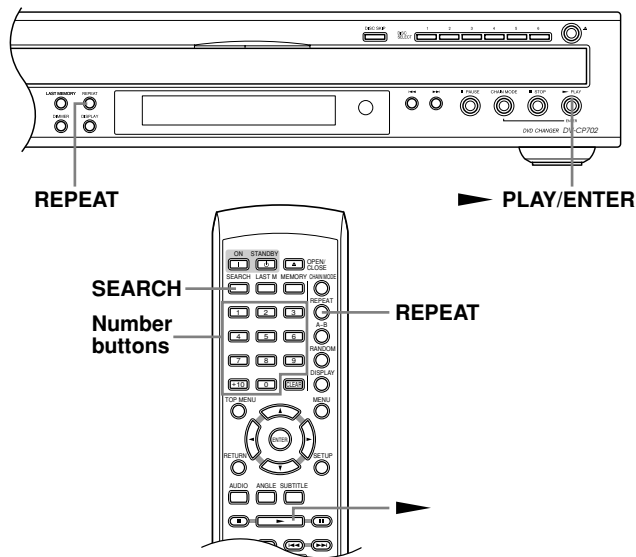

## Notes:

- The Time Search function works only within the currently playing title (DVD-Video) or track (Video CD, audio CD). For example, if the current title is one hour long and you enter the time 1 hour, 30 minutes, nothing will happen.
- In some cases, playback may start from a slightly different point to the one you specified.
- Time Search may not work with some discs.
- You can't use the [SEARCH] button during random playback.

## Repeat Playback



With the Repeat Playback function you can play the current disc, title, chapter, track, or folder of MP3/WMA files over-and-over again.

## Locating Specific Points in Time



With the Time Search function you can locate specific points in time.

<p><b>1</b></p> <p>Remote controller</p>	<p><b>Press the [SEARCH] button twice.</b> The Disc Navigator Search window appears onscreen, as shown.</p>
<p><b>2</b></p> <p>Remote controller</p>	<p><b>Use the number buttons to enter a time.</b> To enter, for example, 1 hour, 25 minutes, 30 seconds, press the [1], [2], [5], [3], and [0] buttons.</p> <p>To enter, for example, 2 minutes, 15 seconds, press the [2], [1], and [5] buttons.</p>
<p><b>3</b></p> <p>Remote controller</p>	<p><b>Press the Play [▶] button to locate the specified point.</b> Playback starts from the specified point.</p>

<p><b>1</b></p> <p>Remote controller</p>	<p><b>Press the [REPEAT] button repeatedly to select a repeat option.</b> The currently selected repeat option appears onscreen and "REPEAT" appears on the display.</p> <p>The available options depend on the current disc type, as follows:</p> <p><b>DVD-Video:</b> Chapter, Title, 1 Disc, All Disc.</p> <p><b>Video CD:</b> 1 Disc, All Disc.</p> <p><b>Audio CD:</b> Track, 1 Disc, All Disc.</p> <p><b>MP3/WMA:</b> Track, Folder, 1 Disc, All Disc.</p>
<p><b>2</b></p> <p>Remote controller</p>	<p><b>Press the Play [▶] button to start repeat playback.</b></p>
<p><b>3</b></p> <p>Remote controller</p>	<p><b>To cancel Repeat Playback, use the [REPEAT] button to select Off.</b></p>

## Notes:

- Repeat Playback may not work with some DVD-Video discs.
- If you press the [REPEAT] button while the Memory Playback function is on (see page 33), the current memory list will play repeatedly.
- With PBC Video CDs, you can't select Repeat Playback. In this case, you need to cancel PBC playback first, and then select Repeat Playback.
- You can't use the repeat functions with Chain mode playback.
- If you select another disc, repeat playback is cancelled.

## Advanced Playback—Continued

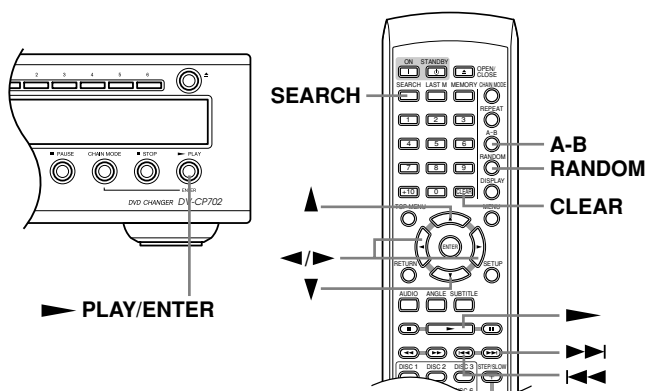

### A–B Repeat Playback

DVD VCD CD

With the A–B Repeat Playback function you can play a specified section over-and-over again.

<p><b>1</b></p> <p>Remote controller</p>	<p><b>During playback, press the [A–B] button to set the A point (i.e., the start of the section you want to repeat).</b></p> <p>“A–” appears onscreen and “R_A” appears on the display</p>
<p><b>2</b></p> <p>Remote controller</p>	<p><b>Press the [A–B] button again to set the B point (i.e., the end of the section you want to repeat).</b></p> <p>Playback repeats between the A and B points, and “A–B” appears onscreen and “R_AB” appears on the display.</p>
<p><b>3</b></p> <p>Remote controller</p>	<p><b>To cancel A–B Repeat Playback, press the [CLEAR] button, or use the [A–B] button to select Off.</b></p>

#### Notes:

- A–B Repeat Playback may not work with some DVD-Video discs and PBC Video CDs.
- In some cases, the A and B points may be at slightly different points to the ones you specified.
- If you select a different camera angle during A–B repeat playback, the original camera angle will be selected when playback restarts from the A point.

### Random Playback

DVD VCD CD MP3 WMA

With the Random Playback function you can enjoy a random selection of discs, titles, chapters, tracks, or MP3/WMA folders.

<p><b>1</b></p>	<p><b>Select a disc.</b></p> <p>See page 22.</p>
<p><b>2</b></p> <p>Remote controller</p>	<p><b>Press the [RANDOM] button repeatedly to select a random option.</b></p> <p>The currently selected random option appears onscreen and “RANDOM” appears on the display.</p> <p>The available options depend on the current disc type, as follows:</p> <p><b>DVD-Video:</b> Title, 1 Disc, All Disc.</p> <p><b>Video CD/audio CD:</b> 1 Disc, All Disc.</p> <p><b>MP3/WMA:</b> Folder, 1 Disc, All Disc (files in subfolders are not played).</p> <p>With the “Title” option, chapters within the current title are played at random. With the “1 Disc” option, all titles, chapters, tracks, and folders on the current disc are played at random.</p> <p>If you press the [RANDOM] button during playback, random playback begins after the current disc, title, chapter, track, or MP3/WMA folder has finished.</p>
<p><b>3</b></p> <p>Remote controller</p>	<p><b>Press the Play [▶] button to start random playback.</b></p> <p>Random playback starts.</p>
<p><b>4</b></p> <p>Remote controller</p>	<p><b>To cancel random playback, use the [RANDOM] button to select Off.</b></p>

#### Notes:

- To select the next random disc, title, chapter, track, or MP3/WMA folder during random playback, press the Next [▶▶] button.
- Random playback may not work with some DVD-Video discs.
- With PBC Video CDs, you can’t use this function. Cancel PBC playback first, and then set this function.
- Random playback cannot be used with the Memory Playback function.
- You can’t use the [SEARCH] button during random playback.
- During random playback, the remote controller’s navigation [▲], [▼], [◀], [▶] buttons don’t work in the Disc Navigator.
- If you select another disc, random playback is cancelled, except when the random option is set to “All Disc,” in which case playback continues.



## Advanced Playback—Continued

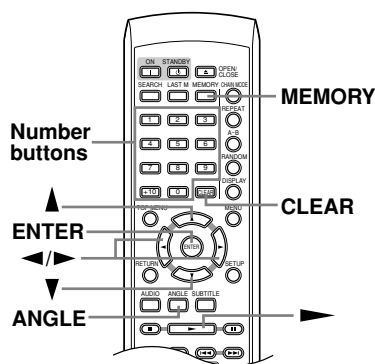

### Memory Playback

DVD VCD CD MP3 WMA JPEG

With the Memory Playback function you can create your own memory list of titles, chapters, and tracks.

**1**

Remote controller

MEMORY



**Press the [MEMORY] button.**

The Memory Play Setup window appears onscreen, as shown.

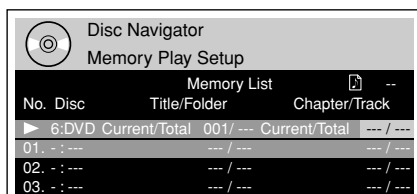

The top row (▶) is used to enter disc, title/folder, and chapter/track numbers. Steps in the memory list are numbered sequentially.

**2**

**Enter the disc, title/folder, and chapter/track numbers of the item you want to add to the memory list.**

Use the remote controller's Left/Right [◀]/[▶] buttons to select the parameters, and use the Up/Down [▲]/[▼] buttons to select numbers from 001 to 999.

The number of the currently selected disc is already entered.

You can enter numbers directly by using the remote controller's number buttons.

To add the all titles, folders, chapters, or tracks on the disc, select the top row (▶), and then press the Down [▼] button.

**3**

Remote controller



**Press the [ENTER] button.**

The new item is added to the memory list as step 01.

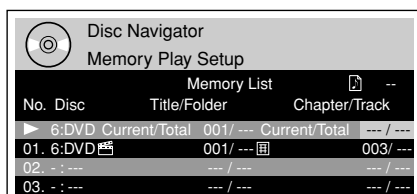

**4**

**Repeat steps 2 and 3 to add more items to the memory list.**

New items will be added to the memory list as steps 02, 03, and so on.

**5**

Remote controller

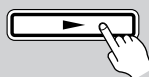

**To play the memory list, press the Play [▶] button.**

The Memory Play Setup window must be open when you press the Play [▶] button.

**6**

Remote controller



**To stop playback, press the Stop [■] button.**

**7**

Remote controller

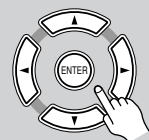

**To insert a new item into the memory list, use the Left/Right [◀]/[▶] buttons to select the list, use the Up/Down [▲]/[▼] buttons to select the step before which you want to insert the new item, and then press the [ENTER] button.**

The cursor moves to the top row and the selected step remains highlighted.

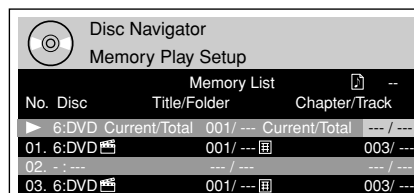

Remote controller



**Enter the disc, title/folder, and chapter/track numbers of the item to be inserted.**

**Press the [ENTER] button.**

The new item is inserted into the memory list and subsequent items move down the list.

**8**

Remote controller

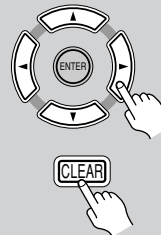

**To delete a step, use the Left/Right [◀]/[▶] buttons to select the list, use the Up/Down [▲]/[▼] buttons to select it, and then press the [CLEAR] button.**

The item is deleted and subsequent items move up the list.

## Advanced Playback—Continued

### 9

Remote controller

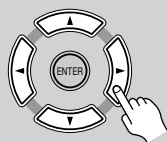

To edit a step, use the Left/Right [◀]/[▶] buttons to select the list, use the Up/Down [▲]/[▼] buttons to select the step, and then use the Left/Right [◀]/[▶] buttons to select the top row (▶) again.

Edit the disc, title/folder, and chapter/track numbers, and then press the [ENTER] button.

### 10

Remote controller

MEMORY



To close the Memory Play Setup window, press the [MEMORY] button.

#### Notes:

- The entire memory list is cleared when the DV-CP702 is set to Standby.
- With PBC Video CDs, you can't use this function. Cancel PBC playback first, and then set this function.
- A playlist of MP3/WMA files can be made using the Disc Navigator (see page 26).

## Selecting Camera Angles

DVD

Some DVD-Video discs feature multiple camera angles that allows you to view scenes from different angles. If the currently playing DVD-Video disc features multiple camera angles, the camera 𐄂 indicator appears onscreen and on the display. Such a disc usually has the multiple camera angle logo (𐄂) printed on its sleeve notes.

Remote controller

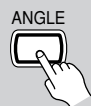

Press the [ANGLE] button repeatedly to cycle through the available camera angles.

The number of the currently selected camera angle appears onscreen. For example, on a disc with three camera angles, you'd see 1/3, 2/3, and 3/3.

#### Notes:

- With some DVD-Video discs you may not be able to select different camera angles even though the camera 𐄂 indicator is displayed.
- With some DVD-Video discs you can select camera angles from a menu.
- Some DVD-Video discs won't allow you to select different camera angles while playback is paused.

## Advanced Playback—Continued

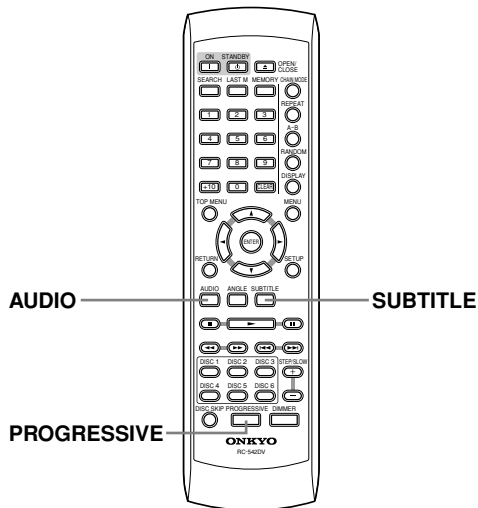

### Selecting Languages & Audio Formats



Some DVD-Video discs feature soundtracks in several languages and audio formats (e.g., Dolby Digital or DTS). Music DVD-Video discs sometimes feature soundtracks in several audio formats, such as PCM or Dolby Digital 5.1. See the disc's sleeve notes for details.

Remote controller



**During playback, press the [AUDIO] button repeatedly to cycle through the available soundtracks.**

The name of the selected soundtrack appears onscreen for several seconds.

For Video CDs, you can select stereo, Mono L (left), or Mono R (right).

#### Notes:

- With DVD-Video discs, when you stop playback and cancel the Resume function (see page 22), or select another disc, the soundtrack language will revert to your default language (see page 42), or the disc's default language.
- With some discs, selecting another soundtrack may cause the picture to skip momentarily.
- To listen to just the accompaniment on a karaoke CD, select the Mono L (left) or Mono R (right) channel. See the disc's sleeve notes for details.
- With some DVD-Video discs you need to select soundtracks from a menu, and you may not be able to select other soundtracks during playback.

### Selecting Subtitles



Some DVD-Video discs feature subtitles in several languages. See the disc's sleeve notes for details.

Remote controller

SUBTITLE



**During playback, press the [SUBTITLE] button repeatedly to cycle through the available subtitles.**

The name of the selected subtitle appears onscreen for several seconds.

To turn off subtitles, use the [SUBTITLE] button to select Off.

#### Notes:

- With DVD-Video discs, when you stop playback and cancel the Resume function (see page 22), or select another disc, the subtitle language will revert to your default subtitle language (see page 42), or the disc's default subtitle language.
- With some DVD-Video discs you can select subtitles from a menu, and you may not be able to select subtitles during playback.
- To check the subtitle language currently selected, press the [SUBTITLE] button once. The current setting will appear onscreen for several seconds.

### Using Progressive Scanning

With the Progressive Scanning function you can enjoy better picture quality. To use Progressive Scanning, your TV or projector must support progressive scanning and you must connect it to the DV-CP702's component video outputs (see page 17).

1

Remote controller

PROGRESSIVE



**Press the [PROGRESSIVE] button.**

Progressive scanning is enabled and the PRGV indicator appears on the display.

2

Remote controller

PROGRESSIVE



**To turn off progressive scanning, press the [PROGRESSIVE] button again.**

The PRGV indicator disappears.

#### Notes:

- If your TV or projector doesn't support progressive scanning and it's connected to the DV-CP702's component video outputs, if you turn on the Progressive Scanning function, you'll get no picture.
- The S-Video and composite video outputs are not affected by the Progressive Scanning function.
- Progressive scanning cannot be turned on or off during playback. You must stop playback first.
- Progressive scanning cannot be turned on or off while the Disc Navigator is displayed.
- See also the Progressive Setting on page 40.
- On the Australian model, progressive scanning can be used with NTSC format discs. To do this, set the PAL Output Setting to "AUTO," start playback of an NTSC disc, stop playback, and then turn on the Progressive Scanning function.

## Advanced Playback—Continued

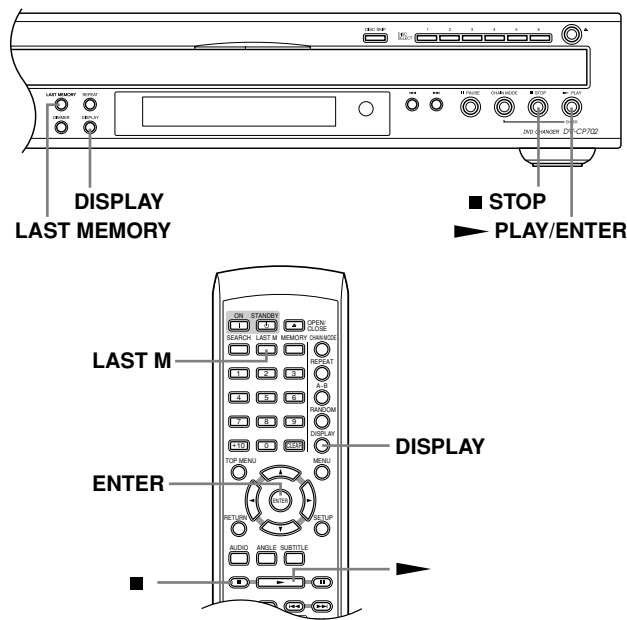

### 4

Remote controller



**To resume playback from last memory point, select “Yes,” and then press [ENTER].**

To start playback from the beginning, select “No,” and then press [ENTER].

To start playback from the beginning and delete the last memory point, select “Memory Clear,” and then press [ENTER].

### Notes:

- The Last Memory function can store the settings for up to six DVD-Video discs. When you set the Last Memory function for a seventh disc, the first disc’s settings are lost.
- The Last Memory function can remember the settings for one Video CD, and those settings will be lost when another disc is selected.
- The Last Memory function may not work properly with some PBC Video CDs.
- The Last Memory function will not work while a menu is being displayed onscreen.
- The Last Memory function may not work with some DVD-Video discs.
- Even if you select another disc, or inadvertently turn off the DV-CP702 during playback, you can resume playback from the same point when you select the disc again.

## Using Last Memory



With the Last Memory function you can resume playback from where you left off even if another disc has been selected or the disc has been removed. Last Memory also remembers the soundtrack and subtitle languages that you were using.

### 1

LAST MEMORY



Remote controller

LAST M



**During playback, press the [LAST M] button.**

The last memory point for the disc is stored, the LAST indicator appears, and “LAST MEM” appears on the display.

If the [LAST M] button is pressed again, the last memory point will be updated.

### 2

STOP



Remote controller



**To stop playback, press the Stop [■] button once or twice.**

**At this point you may choose to play another disc, or to turn off the DV-CP702.**

### 3

PLAY



Remote controller

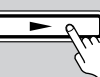

**To resume playback, select the disc and press the Play [▶] button.**



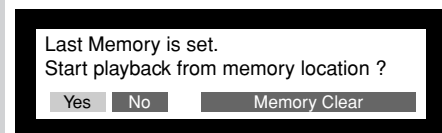





The Last Memory dialog box appears, as shown.



## Advanced Playback—Continued

### Displaying Information

You can display various information about the current disc, title, chapter, or track as follows.





<p><b>1</b></p> <p>DISPLAY</p>  <p>Remote controller</p> <p>DISPLAY</p> 	<p><b>During playback, press the [DISPLAY] button.</b></p> <p>Various information appears onscreen.</p> <p>The operating status (e.g., Stop, Play, Resume), disc number, and disc type information is displayed along the top of the screen.</p> <p>The other information depends on the type of disc currently selected, as follows:</p> <p><b>DVD-Video:</b> Current title number, total number of titles on disc, elapsed title time, remaining title time, total title time, selected soundtrack, selected subtitle, and the number of available camera angles.</p> <p><b>Video CD, audio CD:</b> Current track number, total number of tracks, elapsed track time, remaining track time, and total track time.</p> <p><b>MP3/WMA disc:</b> Track name, current track, elapsed track time, folder name, current folder, total number of tracks, total number of folders.</p>
<p><b>2</b></p> <p>DISPLAY</p>  <p>Remote controller</p> <p>DISPLAY</p> 	<p><b>Press the [DISPLAY] button again to see more information.</b></p> <p><b>DVD-Video:</b> Current chapter number, total number of chapters in title, elapsed chapter time, remaining chapter time, total chapter time, and bit rate.</p> <p><b>Video CD, audio CD:</b> Current track number, total number of tracks, elapsed disc time, remaining disc time, and total disc time. (Does not work with PBC Video CDs.)</p> <p><b>MP3/WMA disc:</b> Title, artist name, album name, year, genre, comment.</p>
<p><b>3</b></p> <p>DISPLAY</p>  <p>Remote controller</p> <p>DISPLAY</p> 	<p><b>Press the [DISPLAY] button again to cancel the information display.</b></p>
<p><b>4</b></p> <p>DISPLAY</p>  <p>Remote controller</p> <p>DISPLAY</p> 	<p><b>If the current disc is an MP3/WMA disc, and you want to open the Disc Navigator, press the [DISPLAY] button again.</b></p>

# Configuring the DV-CP702

This chapter explains the various functions and settings of the onscreen setup menus.

Functions and settings are arranged into six menus: Picture, Audio, Language, Display, Operation Setting, and Initial.

The following table lists all the functions and settings, with a brief description and page number where you can find full details.

Menu	Setting	Description	Page #	
<b>Picture</b> 	TV Shape	Select a picture format to match the aspect ratio of your TV.	39	
	Interlaced Setting	Adjust the picture quality for interlaced scanning.	40	
	Progressive Setting	Adjust the picture quality for progressive scanning.	40	
	PAL Output Setting (Australian model only)	Specify how the DV-CP702 outputs video signals when playing NTSC discs.	40	
<b>Audio</b> 	Digital Out	Dolby Digital Out	Select whether or not the DV-CP702 downmixes Dolby Digital digital audio.	41
		Linear PCM Out	Select whether or not the DV-CP702 downsamples 96 kHz digital audio.	41
		MPEG Out	Select whether or not the DV-CP702 downmixes MPEG digital audio.	41
		Digital Out	Turn on or off the digital audio outputs.	41
	Dynamic Range Control (Dolby Digital only)	Set the Dynamic Range function.	41	
<b>Language</b> 	On-Screen Language	Select a language for the onscreen setup menus and messages.	41	
	Disc Menu Language	Select your preferred language for disc menus.	42	
	Audio Language	Select your preferred language for soundtracks.	42	
	Subtitle	Select your preferred language for subtitles.	42	
<b>Display</b> 	On-Screen Display	Turn on or off onscreen messages and indicators.	42	
	On-Screen Display Color	Select a color for onscreen setup menus and messages.	42	
	Background	Select a background color for when playback is stopped.	42	
	Screen Saver	Set the Screen Saver function.	43	
	Pause/Still	Select Auto or Frame for still pictures.	43	
<b>Operation Setting</b> 	Parental Lock	Set the Parental Lock function.	43	
	PBC	Turn on or off PBC (Playback Control) functions for Video CDs.	43	
	Auto Power Off	Set the Auto Power Off function.	44	
	Initial Setup	TV Shape	This menu appears automatically the very first time you turn on your DV-CP702. (These settings are available in other menus.)	20
On-Screen Language				
Digital Out				

## Configuring the DV-CP702—Continued

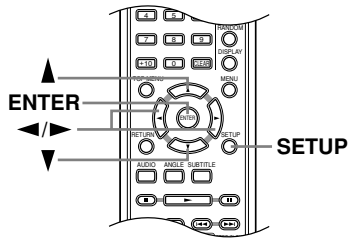

### Using the Onscreen Setup Menus

This section explains how to use the onscreen setup menus.

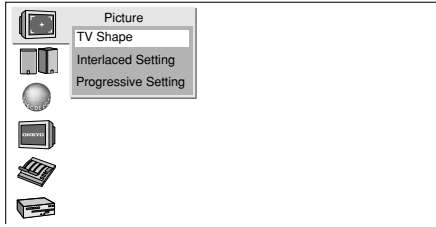
<b>1</b>	<p><b>Turn on your DV-CP702 and TV.</b></p> <p>On your TV, select the video input to which the DV-CP702 is connected.</p>
<b>2</b> Remote controller	<p><b>Press the [SETUP] button.</b></p> <p>The onscreen setup menu appears, as shown.</p> 
<b>3</b> Remote controller	<p><b>Use the remote controller's navigation buttons to navigate the menus.</b></p> <p>Use the Left/Right [◀]/[▶] buttons to move left or right. Use the Up/Down [▲]/[▼] buttons to move up or down.</p>
<b>4</b> Remote controller	<p><b>When you've selected an item, press the [ENTER] button to see the available options.</b></p>
<b>5</b> Remote controller	<p><b>Use the navigation buttons to select the options, and press the [ENTER] button to confirm your selection.</b></p>
<b>6</b> Remote controller	<p><b>When you've finished, press the [SETUP] button again.</b></p> <p>The onscreen setup menu closes.</p>

### Picture Menu

#### TV Shape



With this setting you can select a picture format to match the aspect ratio of your TV.

**4:3 Letter box (default):** Choose this option if you have a standard TV (4:3 aspect ratio). When you watch widescreen DVD-Video movies, the entire picture will be visible and there will be black bars at the top and bottom of the screen, as shown.



Widescreen DVD movie on standard TV with "4:3 Letter box" setting

**4:3 Normal (Pan & Scan):** Choose this option if you have a standard TV (4:3 aspect ratio) and want to use the full height of the screen when watching widescreen DVD-Video movies. In order to use the full height of the screen, the picture will be cropped on both sides, as shown. This option won't work with discs that don't support pan and scan.



Widescreen DVD movie on standard TV with "4:3 Normal" setting

**16:9 Widescreen:** Choose this option if you have a wide-screen TV (16:9 aspect ratio).

**16:9 Compressed:** Choose this option if you have a widescreen TV (16:9 aspect ratio) and the picture appears stretched when watching programs in 4:3 format, as shown. Some widescreen TVs have a setting to correct this. If your TV doesn't, and 4:3 programs appear stretched, select this option to correct the problem.



4:3 program on widescreen TV with "16:9 Compressed" setting

#### Notes:

- With some DVD-Video discs this setting may have no effect. See the disc's sleeve notes to see which picture format is used.

## Configuring the DV-CP702—Continued

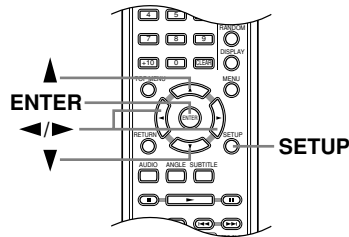

### Interlaced Setting

DVD

With these settings you can adjust various picture quality parameters for interlaced scanning, including black level, contrast, brightness, color, and so on.

There are three memories (1, 2, 3) for storing your favorite settings. You could, for example, use one for daytime viewing (e.g., sun shining through window) and one for nighttime viewing (e.g., curtains drawn, lights down).

The parameters are as follows.

Parameter	Range
Contrast	-7...0...+7
Brightness	-7...0...+7
Color	-7...0...+7
Tint	-7...0...+7
Sharpness	0...+8
Skin Tone Compensation	-7...0...+7
Video Black Level	Dark, Normal (U.S. model only) Normal, Light (Australian model only)

<b>1</b> Remote controller 	<b>Select Interlaced Setting 1, 2, or 3, and then press the [ENTER] or Right [▶] button.</b> The parameters appear onscreen.
<b>2</b> Remote controller 	<b>Use the Up/Down [▲]/[▼] buttons to select the parameters, press the [ENTER] button, and use the Left/Right [◀]/[▶] buttons to set them.</b>
<b>3</b> Remote controller 	<b>When you've finished, press the [SETUP] button.</b> The settings are stored.

#### Notes:

- These settings are used only when the Progressive function is off.

### Progressive Setting

DVD

With these settings you can adjust various picture quality parameters for progressive scanning, including black level, contrast, brightness, color, and so on.

There are three memories (1, 2, 3) for storing your favorite settings. You could, for example, use one for daytime viewing (e.g., sun shining through window) and one for nighttime viewing (e.g., curtains drawn, lights down).

Parameter	Range
Contrast	-7...0...+7
Brightness	-7...0...+7
Color	-7...0...+7
Tint	-7...0...+7
Sharpness	0...+8
Skin Tone Compensation	-7...0...+7

<b>1</b> Remote controller 	<b>Select Progressive Setting 1, 2, or 3, and then press the [ENTER] or Right [▶] button.</b> The parameters appear onscreen.
<b>2</b> Remote controller 	<b>Use the Up/Down [▲]/[▼] buttons to select the parameters, press the [ENTER] button, and use the Left/Right [◀]/[▶] buttons to set them.</b>
<b>3</b> Remote controller 	<b>When you've finished, press the [SETUP] button.</b> The settings are stored.

#### Notes:

- These settings are used only when the Progressive function is on.

### PAL Output Setting (Australian model only)

DVD VCD

With this setting you can specify how the DV-CP702 outputs video signals when playing NTSC format DVD-Video discs or Video CDs.

**AUTO (default):** Use this option to watch PAL and NTSC format discs. The DV-CP702 does not convert the video format. When you play a PAL disc, the video output will be PAL format. And when you play an NTSC disc, it'll be NTSC format. Your TV must support NTSC playback in order to watch NTSC format discs.

**PAL:** Use this option if your TV doesn't support NTSC playback, or the picture is distorted when watching NTSC discs. The DV-CP702 will convert NTSC format video signals to PAL-compatible format.

#### Notes:

- This setting can be changed only when playback is stopped.



## Configuring the DV-CP702—Continued

### Audio Menu

#### Digital Out

With these settings you can specify how the DV-CP702 outputs digital audio signals. The options you choose will depend on the type of AV component that you connect to the DV-CP702's digital audio outputs.

#### ■ Dolby Digital Out

*DVD*

With this setting you can configure the DV-CP702 to output Dolby Digital audio as it is or downmix it to 2-channel PCM.

If you're connecting the DV-CP702's digital audio outputs to an AV component with a built-in Dolby Digital decoder, select Dolby Digital. If you're connecting to a hi-fi amp with a digital input, an AV receiver with a built-in Dolby Pro Logic decoder, or an external D/A converter, select Dolby Digital > PCM.

**Dolby Digital (default):** Dolby Digital audio is output as it is.

**Dolby Digital > PCM:** Dolby Digital audio is downmixed and output as 2-channel PCM digital audio.

#### ■ Linear PCM Out

*DVD*

With this setting you can configure the DV-CP702 to output digital audio with higher sampling rates (e.g., 96 kHz) as it is or downsample it to 48 kHz.

If the AV component you connect to the DV-CP702's digital audio outputs supports 96 kHz digital audio, select Down Sample Off. Otherwise, select Down Sample On.

**Down Sample On (default):** 96 kHz digital audio is downsampled and output at 48 kHz.

**Down Sample Off:** 96 kHz digital audio is output as it is.

#### Notes:

- Some copy-protected DVD-Video discs may use 96 kHz digital audio only for A/D conversion to the analog audio outputs.
- With some discs, even if you select Down Sample Off, the digital audio will be downsampled to 48 kHz, and in some cases may not be output by the DV-CP702's digital audio outputs.

#### ■ MPEG Out

*DVD* *VCD*

With this setting you can configure the DV-CP702 to output MPEG digital audio as it is or downmix it to PCM.

If you're connecting the DV-CP702's digital audio outputs to an AV component with a built-in MPEG decoder, select MPEG. Otherwise, select MPEG > PCM.

**MPEG (default):** MPEG digital audio is output as it is.

**MPEG > PCM:** MPEG digital audio is downmixed and output as PCM digital audio.

#### ■ Digital Out

*DVD* *VCD* *CD* *MP3* *WMA*

With this setting you can turn the coaxial and optical digital audio outputs on or off.

Depending on how you connect the DV-CP702 to your other AV components, there may be situations where it's helpful to be able to turn off the digital audio outputs.

**On (default):** Digital audio signals are output by the coaxial and optical digital audio outputs.

**Off:** Nothing is output by the coaxial and optical digital audio outputs.

#### Notes:

- This setting has no effect on the analog audio outputs.

#### Dynamic Range Control (Dolby Digital only)

*DVD*

With the Dynamic Range Control function you can reduce the dynamic range of Dolby Digital material so that you can still hear quiet parts even when listening at low volume levels—ideal for watching movies late at night when you don't want to disturb anyone.

**Off (default):** The full dynamic range is preserved.

**On:** The dynamic range of Dolby Digital material is compressed.

#### Notes:

- The impact of the Dynamic Range Control function depends on the Dolby Digital material that you are playing and with some material there will be little or no effect.

### Language Menu

#### On-Screen Language

*DVD* *VCD* *CD* *MP3* *WMA* *JPEG*

With this setting you can select a language for the onscreen setup menus and messages.

**English (default):** English.

**Français:** French.

**Español:** Spanish.

**Deutsch:** German.

**Italiano:** Italian.

## Configuring the DV-CP702—Continued

### Disc Menu Language



With this setting you can select your preferred language for disc menus. When you play a DVD-Video disc with multiple language disc menus, your preferred language will be selected automatically.

**English (default):**

**French:**

**Spanish:**

**German:**

**Italian:**

**Others:** See “Selecting Other Languages” on page 44.

#### Notes:

- Not all DVD-Video discs have menus in multiple languages.
- Even if a DVD-Video disc has menus in multiple languages, this setting may not always work.
- If a DVD has only one menu language, that will be used.
- With some DVD-Video discs you can select languages from a menu.

### Audio Language



With this setting you can select your preferred language for soundtracks. When you play a DVD-Video disc with multiple language soundtracks, your preferred language will be selected automatically.

**English (default):**

**French:**

**Spanish:**

**German:**

**Italian:**

**Others:** See “Selecting Other Languages” on page 44.

#### Notes:

- Not all DVD-Video discs have soundtracks in multiple languages.
- Even if a DVD-Video disc has soundtracks in multiple languages, this setting may not always work.
- If a DVD has only one soundtrack, that will be used.
- With some DVD-Video discs you can select languages from a menu.

### Subtitle



With this setting you can select your preferred language for subtitles. When you play a DVD-Video disc with multiple language subtitles, your preferred language will be selected automatically.

**English (default):**

**French:**

**Spanish:**

**German:**

**Italian:**

**No Subtitle:** No subtitles will be displayed. This option is useful with DVD-Video discs that always display subtitles.

**Others:** See “Selecting Other Languages” on page 44.

#### Notes:

- Not all DVD-Video discs have subtitles.
- Even if a DVD-Video disc has subtitles in multiple languages, this setting may not always work.
- If a DVD has only one subtitle language, that will be used.
- With some DVD-Video discs you can select subtitles from a menu.

## Display Menu

### On-Screen Display



With this setting you can turn on or off onscreen messages, such as “Play,” “Stop,” and “Resume.”

**Off:** Onscreen messages are not displayed.

**On (default):** Onscreen messages are displayed.

### On-Screen Display Color



With this setting you can set the color and theme of the Disc Navigator window.

**Sapphire (default):**

**Pearl:**

**Amethyst:**

**Garnet:**

### Background

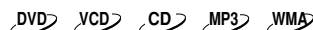

With this setting you can select the color of the background that's displayed when the DV-CP702 is stopped.

**Blue:**

**Gray:**

**Graphic (default):** The theme picture specified for the On-Screen Display Color setting is used.

## Configuring the DV-CP702—Continued

### Screen Saver

DVD VCD CD MP3 WMA JPEG

With the Screen Saver function you can protect your TV against screen burn-in, which can occur when the same image or menu is displayed for a long time.

**Off:** Screen saver off.

**On (default):** Screen saver on.

When the Screen Saver function is set to On, and DVD-Video or Video CD playback is paused or stopped for 15 minutes, the Screen Saver function automatically displays a moving image.

Once the screen saver has been activated, you can cancel it by pressing either the Play [▶] button or Pause [■] button.

#### Notes:

- The Screen Saver function also works with audio CDs and MP3/WMA discs. If you leave playback paused for five minutes, the screen saver will activate.

## Operation Setting Menu

### Pause/Still

DVD

The Pause/Still setting determines how still pictures are displayed when DVD-Video playback is paused or when using frame-by-frame playback.

**Auto (default):** A frame or field is displayed depending on the disc.



**Frame:** A frame is displayed.



TV pictures are made up of fields, and there are two fields per picture (*frame*). In general, the Frame option will provide the best picture quality, although in some cases the picture may appear slightly blurred. Since a field has only half as much information, the picture quality will be lower, but it won't be blurred.

### Parental Lock

DVD

With the Parental Lock function you can block access to certain scenes that the authors have flagged as being unsuitable for children.

<p><b>1</b></p> <p>Remote controller</p> 	<p><b>Select Parental Lock→On, and then press the [ENTER] button.</b></p> <p>The Security Code box appears onscreen.</p>
<p><b>2</b></p> <p>Remote controller</p> 	<p><b>Use the number buttons to enter a 4-digit security code, and then press [ENTER].</b></p> <p>The Level box appears onscreen.</p>

<p><b>3</b></p> <p>Remote controller</p> 	<p><b>Use the Up/Down [▲]/[▼] buttons to specify the parental lock level from 1 through 8, and then press [ENTER].</b></p> <p>The parental lock is now set.</p> <p>The parental lock levels conform to U.S. movie ratings as follows:</p> <ul style="list-style-type: none"> <li>• Level 7: NC-17</li> <li>• Level 6: R</li> <li>• Level 4: PG13</li> <li>• Level 3: PG</li> <li>• Level 1: G</li> </ul>
<p><b>4</b></p> <p>Remote controller</p> 	<p><b>When you've finished, press the [SETUP] button.</b></p> <p>The settings are stored.</p>

#### Notes:

- When entering a security code, you can use the [CLEAR] button to delete the numbers entered so far, if necessary.
- This setting can be changed only when playback is stopped.
- Once this setting has been turned on and a security code set, if you want to turn off parental lock, or change the parental lock level, you'll be prompted to enter the security code.
- Not all discs use parental lock. See the disc's sleeve notes for details.
- Discs with parental lock may cut certain scenes, replace certain scenes with children-friendly scenes, or prevent playback of the entire disc.
- If you forget the security code, instead of entering the numbers, press the STOP [■] button four times.
- When using a disc that uses parental control to restrict playback, occasionally, depending on the DV-CP702's operating status, you may not be able to remove the disc by using the [OPEN/CLOSE] button. If this does occur, close the disc tray, use the [DISC SKIP] button to select another disc bay, open the tray again, and then remove the disc.

### PBC

VCD

With the PBC setting you can enable or disable PBC (Playback Control) functions on Video CDs.

**Off:** PBC functions disabled.

**On (default):** PBC functions enabled.

#### Notes:

- PBC functionality varies from disc-to-disc. See the disc's sleeve notes for details.
- Not all PBC Video CDs use all of the PBC functions supported by the DV-CP702

## Configuring the DV-CP702—Continued

### Auto Power Off

DVD VCD CD MP3 WMA JPEG

With the Auto Power Off function the DV-CP702 will turn itself off automatically if about 20 minutes have elapsed without any operation after stopping playback.

**Off (default):** Auto Power Off function is off.



**On:** Auto Power Off function on.

### Initial Setup Menu

This menu appears automatically the very first time you turn on the DV-CP702. See “First Time Setup” on page 20 for more information.

### Selecting Other Languages

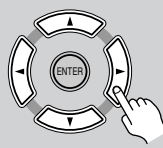
This section explains how to select other languages for disc menus, audio, and subtitles.

<p><b>1</b></p> <p>Remote controller</p> 	<p><b>Select “Others” from the Disc Menu Language, Audio Language, or Subtitle menu, and then press [ENTER].</b></p> <p>The language code boxes appear.</p>
<p><b>2</b></p> <p>Remote controller</p> 	<p><b>Use the remote controller’s Left/Right [◀]/[▶] buttons to select the code boxes.</b></p> <p><b>Use the Up/Down [▲]/[▼] buttons to enter a language code.</b></p> <p>See adjacent table for language codes.</p>
<p><b>3</b></p> <p>Remote controller</p> 	<p><b>When you’ve finished, press the [ENTER] button.</b></p>

### Language Code List

Use this list when specifying other languages.

Language	Code	Language	Code
Japanese	JA	Kirghiz	KY
English	EN	Latin	LA
French	FR	Lingala	LN
German	DE	Laothian	LO
Italian	IT	Lithuanian	LT
Spanish	ES	Latvian	LV
Chinese	ZH	Malagasy	MG
Dutch	NL	Maori	MI
Portuguese	PT	Macedonian	MK
Swedish	SV	Malayalam	ML
Russian	RU	Mongolian	MN
Korean	KO	Moldavian	MO
Greek	EL	Marathi	MR
Afar	AA	Malay	MS
Abkhazian	AB	Maltese	MT
Afrikaans	AF	Burmese	MY
Amharic	AM	Nauru	NA
Arabic	AR	Nepali	NE
Assamese	AS	Norwegian	NO
Aymara	AY	Occitan	OC
Azerbaijani	AZ	Oromo	OM
Bashkir	BA	Oriya	OR
Byelorussian	BE	Panjabi	PA
Bulgarian	BG	Polish	PL
Bihari	BH	Pashto, Pushto	PS
Bislama	BI	Quechua	QU
Bengali	BN	Rhaeto-Romance	RM
Tibetan	BO	Kirundi	RN
Breton	BR	Romanian	RO
Catalan	CA	Kinyarwanda	RW
Corsican	CO	Sanskrit	SA
Czech	CS	Sindhi	SD
Welsh	CY	Sangho	SG
Danish	DA	Serbo-Croatian	SH
Bhutani	DZ	Sinhalese	SI
Esperanto	EO	Slovak	SK
Estonian	ET	Slovenian	SL
Basque	EU	Samoan	SM
Persian	FA	Shona	SN
Finnish	FI	Somali	SO
Fiji	FJ	Albanian	SQ
Faroese	FO	Serbian	SR
Frisian	FY	Siswati	SS
Irish	GA	Sesotho	ST
Scots-Gaelic	GD	Sundanese	SU
Galician	GL	Swahili	SW
Guarani	GN	Tamil	TA
Gujarati	GU	Telugu	TE
Hausa	HA	Tajik	TG
Hindi	HI	Thai	TH
Croatian	HR	Tigrinya	TI
Hungarian	HU	Turkmen	TK
Armenian	HY	Tagalog	TL
Interlingua	IA	Setswana	TN
Interlingue	IE	Tonga	TO
Inupiak	IK	Turkish	TR
Indonesian	IN	Tsonga	TS
Icelandic	IS	Tatar	TT
Hebrew	IW	Twi	TW
Yiddish	JI	Ukrainian	UK
Javanese	JW	Urdu	UR
Georgian	KA	Uzbek	UZ
Kazakh	KK	Vietnamese	VI
Greenlandic	KL	Volapük	VO
Cambodian	KM	Wolof	WO
Kannada	KN	Xhosa	XH
Kashmiri	KS	Yoruba	YO
Kurdish	KU	Zulu	ZU

# Troubleshooting

Symptom	Possible cause	Remedy
<b>Can't turn on the DV-CP702?</b>	The power cord is not connected.	Connect the power cord to a suitable wall outlet (page 20).
	External interference is affecting the DV-CP702's digital circuitry.	Turn off the DV-CP702, wait five seconds, then try turning it on again. If that fails, disconnect the power cord from the wall outlet, wait five seconds, reconnect it, then try turning it on again.
<b>No picture?</b>	The wrong input source is selected on your TV.	On your TV, select the input to which the DV-CP702 is connected (page 17).
	The video cable is not connected properly.	Check the video cable and correct as necessary (page 17).
<b>No sound?</b>	The wrong input source is selected on your hi-fi amp or AV receiver.	On your hi-fi amp or AV receiver, select the input to which the DV-CP702 is connected (page 18).
	The audio cable is not connected properly.	Check the audio cable and correct as necessary (page 18).
	The hi-fi amp or AV receiver connected to the DV-CP702's audio outputs is not on.	Turn on the hi-fi amp or AV receiver.
	The Digital Out setting is incorrect.	Check the Digital Out setting and correct as necessary (page 41).
<b>The picture distorts occasionally?</b>	The disc is dirty.	Remove the disc and clean it (page 9).
	You're using the Fast Forward or Fast Reverse function.	A little picture distortion may occur when using these functions. This is normal.
<b>Picture instability or noise?</b>	The DV-CP702 is connected to your TV via a VCR or other video equipment and its copy protection system is affecting the picture.	Connect the DV-CP702 directly to your TV (page 17).
<b>Can't start playback?</b>	No discs loaded.	Load some discs (page 21).
	The selected disc cannot be played because it's incompatible.	Load only compatible discs (page 7).
	The disc is upside down.	Load the disc the correct way up (page 21).
	The disc is not centered in the disc bay.	Place the disc in the center of the disc bay (page 21).
	The disc is dirty.	Remove the disc and clean it (page 9).
	The selected disc has parental lock and the Parental Lock function is on.	Turn off the Parental Lock function (page 43).
<b>Can't play MP3/WMA/JPEG discs?</b>	The disc is not ISO9660 Level 2 format.	Use only ISO9660 Level 2 format discs (page 8).
	The disc has not been finalized.	Finalize the disc (page 8).
<b>Can't select MP3 files?</b>	MP3 files without a ".mp3" or ".MP3" filename extension are not recognized.	Use the correct filename extension (page 8).
<b>Can't play WMA files?</b>	WMA files without a ".wma" or ".WMA" or ".ASF" filename extension are not recognized.	Use the correct filename extension (page 8).
	The WMA file's copyright option is on.	Don't use the copyright option (page 8).
<b>Can't view JPEG files?</b>	JPEG files without a ".jpg" or ".JPG" or ".JPEG" filename extension are not recognized.	Use the correct filename extension (page 8).
	Only Baseline JPEG files are supported. Progressive JPEG files are not.	Use Baseline JPEG files (page 8).
	Only JPEG files with the following brightness/color difference ratios are supported: 4:4:4, 4:2:2, and 4:1:1.	Use JPEG files with the supported ratio (page 8).
	The JPEG file is too big.	Use JPEG files that are less than 5 megabytes (page 8).

## Troubleshooting—Continued

Symptom	Possible cause	Remedy
<b>The message “NO PLAY” appears on the display?</b>	The disc is dirty.	Remove the disc and clean it (page 8).
<b>Buttons on the DV-CP702 and remote controller don’t work?</b>	Power supply voltage fluctuations and other anomalies, such as static electricity, can interfere with normal operation.	Turn off the DV-CP702, wait five seconds, then turn it on again. If that doesn’t resolve the issue, disconnect the power cord from the wall outlet, wait five seconds, reconnect it, then try again.
<b>Buttons on the DV-CP702 work OK but those on the remote controller don’t?</b>	There are no batteries in the remote controller.	Install new batteries (page 15).
	The batteries are flat.	Replace with new batteries (page 15).
	The batteries are installed incorrectly.	Check the batteries and correct as necessary (page 15).
	You’re not pointing the remote controller at the DV-CP702’s remote sensor.	Point the remote controller at the DV-CP702’s remote sensor (page 15).
	You’re too far away from the DV-CP702.	Use the remote controller closer to the DV-CP702 (page 15). The remote controller has a range of approximately 16 ft. (5 meters).
	A strong light source is interfering with the DV-CP702’s remote sensor.	Make sure that the DV-CP702 is not subjected to direct sunshine or inverter-type fluorescent lights. Relocate if necessary.
	If the DV-CP702 is installed in a cabinet with colored glass doors, the remote controller may not work reliably when the doors are closed.	Open the doors, or use a cabinet without colored glass.

### ■ Abnormal Behavior

The DV-CP702 contains a microcomputer for signal processing and control functions. In very rare situations, severe interference, noise from an external source, or static electricity may cause it to lockup. In the unlikely even that this should happen, unplug the power cord from the wall outlet, wait at least five seconds, and then plug it back in again. Alternatively, press and hold the STOP [■] button until “RESET” appears on the display (about 10 seconds).

### ■ Restoring the Default Settings

To reset the DV-CP702 to its factory defaults, turn it on and, while holding down the STOP [■] button, press the [STANDBY/ON] button. “INITIALIZE” appears on the display. When the reset is complete, “COMPLETE” is displayed, and the DV-CP702 enters Standby mode.

# Specifications

<b>Video system</b>		Standard NTSC (U.S. model), PAL/AUTO (Australian model)
<b>Region code</b>		1 (U.S. model), 4 (Australian model)
<b>Laser</b>		Semiconductor laser, wavelength 650 nm (DVD), 780 nm (CD)
<b>Frequency response</b>	<b>DVD linear audio</b>	4 Hz–22 kHz @ 48 kHz sampling rate 4 Hz–44 kHz @ 96 kHz sampling rate
	<b>CD audio</b>	4 Hz–20 kHz
<b>Signal-to-noise ratio (digital audio)</b>		100 dB
<b>Audio dynamic range (digital audio)</b>		95 dB
<b>Harmonic distortion (digital audio)</b>		0.006%
<b>Wow and flutter</b>		Below measurable level
<b>Operating conditions</b>	<b>Temperature</b>	5° to 35° C (41° F to 95° F)
	<b>Installation</b>	Install horizontally
<b>Video outputs</b>	<b>COMPONENT VIDEO</b>	Y: 1.0 V (p–p), 75 Ω, negative sync, RCA/phono x3 Pb/Pr: 0.7 V (p–p), 75 Ω
	<b>S VIDEO (S-Video)</b>	Y: 1.0 V (p–p), 75 Ω, negative sync, 4-pin mini DIN x1 C: 0.286 V (p–p), 75 Ω
	<b>VIDEO (composite video)</b>	1.0 V (p–p), 75 Ω, negative sync, RCA/phono x1
<b>Audio outputs</b>	<b>OPTICAL</b>	–22.5 dBm, optical connector x1
	<b>COAXIAL</b>	0.5 V (p–p), 75 Ω, RCA/phono x1
	<b>ANALOG</b>	2.0 V rms, 440 Ω, RCA/phono x2
<b>General</b>	<b>Power supply</b>	120 V AC, 60 Hz (U.S. model) 230–240 V AC, 50/60 Hz (Australian model)
	<b>Power consumption</b>	13 W
	<b>Power consumption in Standby mode</b>	0.95 W (U.S. model) 0.96 W (Australian model)
	<b>Weight</b>	5.3 kg (11.7 lbs.)
	<b>Dimensions (W x H x D)</b>	435 X 91 X 432 mm (17-1/8 X 3-9/16 X 17)

Specifications and features subject to change without notice.

## **ONKYO CORPORATION**

Sales & Product Planning Div. : 2-1, Nisshin-cho, Neyagawa-shi, OSAKA 572-8540, JAPAN  
Tel: 072-831-8023 Fax: 072-831-8124

### **ONKYO U.S.A. CORPORATION**

18 Park Way, Upper Saddle River, N.J. 07458, U.S.A.  
Tel: 201-785-2600 Fax: 201-785-2650 <http://www.onkyousa.com>

### **ONKYO EUROPE ELECTRONICS GmbH**

Liegnitzerstrasse 6, 82194 Groebenzell, GERMANY  
Tel: +49-8142-4401-0 Fax: +49-8142-4401-555 <http://www.onkyo.net>

### **ONKYO CHINA LIMITED**

Units 2102-2107, Metroplaza Tower I, 223 Hing Fong Road, Kwai Chung,  
N.T., HONG KONG Tel: 852-2429-3118 Fax: 852-2428-9039



SN 29343662

(C) Copyright 2004 ONKYO CORPORATION Japan. All rights reserved.

I0402-1