

Digital Copier

Operating Instructions (For Copier)

DP-2000

Options

DA-AR250/AS200/DS200/DS210/ES200/FG230/FG231/FK200/FK210/FS200/MD200

DA-NE200/PC200/PC210/SM08B/SM16B/SM28B/UC200/XN200/XT200; UE-410047/410048/403171

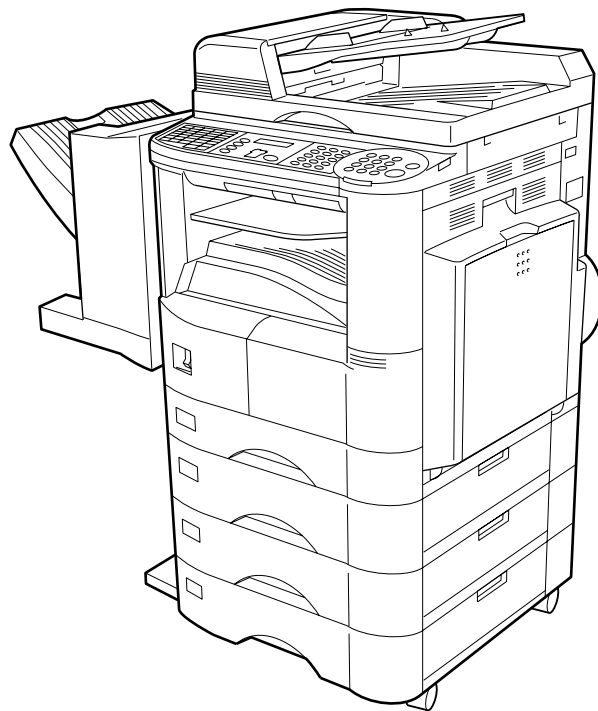

Before operating this copier, please read these instructions completely and keep these operating instructions for future reference.

Digital copier with options
(See P.38)

English

Operation Chart

Common Features and Usage

Basic Operation

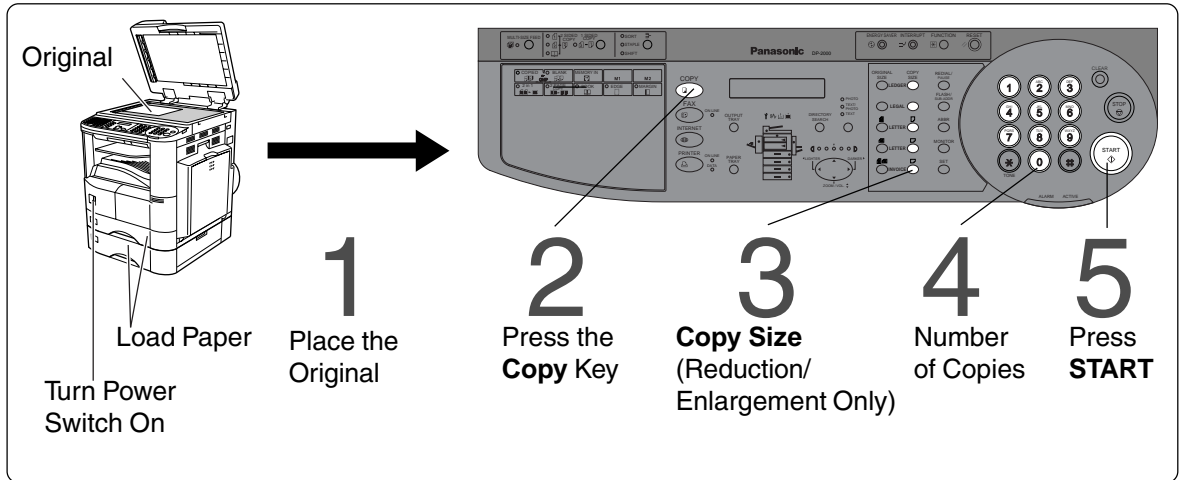

Position of the Original

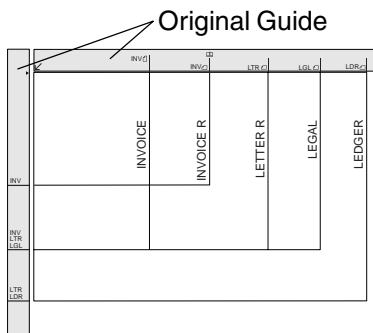

- Place originals face down on the platen or face up on the ADF/i-ADF.
- If the original is not positioned properly, a portion of the original may not be copied.
- For originals smaller than invoice size, position the original within the area of INVOICE and select invoice.

Commonly Used Functions and Operating Procedures

Full Size

Makes a copy that is the same size as the original

1 → 2 → 4 → 5

(See P.12)

Reduction or Enlargement

Copies the original at a fixed reduction or enlargement ratio

1 → 2 → 3 → 4 → 5

(See P.13)

Memory Capacity

When the memory becomes full during original scanning, the message "Function not available for lack of memory" will be displayed in the message display. In this case, follow the operating instruction in the message display.

When additional memory is required, consult with an authorized servicing dealer.

NOTE

- During the copy operation and after making copies, the fan motor may start spinning. This is a normal operation and is used to cool down the copier.

Energy Star



The DP-2000 copier complies with Tier 2 of the Environmental Protection Agency's Energy Star Program. This voluntary program specifies specific energy consumption and usage standards for copiers. These copiers will automatically "power down" after a specified period of non-use. The use of these Energy Star compliant copiers will reduce energy consumption and ultimately benefit the environment.

The default functions can be adjusted depending on your office requirements. Please see your authorized Panasonic copier dealer for more details.

Table of Contents

Getting To Know Your Machine

Operation Chart	2
■ Common Features and Usage	2

Before Starting

Precautions	6
■ For Your Safety	6
■ Handling	7
■ Toner and Paper	7
■ Ventilation	7
■ Installation	8
Control Panel	9

Making Copies

Basic Copy	12
■ Full Size Copying	12
■ Reduction or Enlargement Copying	13
■ Using the Sheet Bypass	15
Duplex Copy	16
■ 2-Sided/1-Sided Copy	16
■ 2 in 1 Copy	19
■ 2 Page Copy	20
Margin	21
■ Book/Edge/Margin	21
Insertion Copy	22
■ OHP Interleaving	22
Job Memory	23
Other Features	24
■ Energy Saver/Interrupt Mode	24
■ Skyshot Mode	25
Combined Function Table	27
Function	28
■ General Functions	29
■ Copier Settings	30
■ General Functions for Key Operator	31
■ Copier Settings for Key Operator	32
■ Function Setting	33
■ Function Setting for Key Operator	34

Table of Contents

Options

Accessories	38
■ Components	38
■ Automatic Document Feeder	39
■ Finisher/Exit Guide Unit	41

Problem Solving

Problem Solving	45
■ Adding Paper (↓)	45
■ Replacing the Toner Cartridge and Waste Toner Box (↓)	46
■ Removing a Misfed Paper	48
Troubleshooting	56
■ Before Calling Service	56
■ Replacing the Battery	58

Others

Specifications	59
Options and Supplies	61

Precautions

For Your Safety

■ Laser Safety

LASER SAFETY

This unit employs a laser. Only qualified service personnel should attempt to service this device due to possible eye injury.

CAUTION:

USE OF CONTROLS, ADJUSTMENTS OR PERFORMANCE PROCEDURES OTHER THAN THOSE SPECIFIED HEREIN MAY RESULT IN HAZARDOUS RADIATION EXPOSURE.

■ Caution Labels

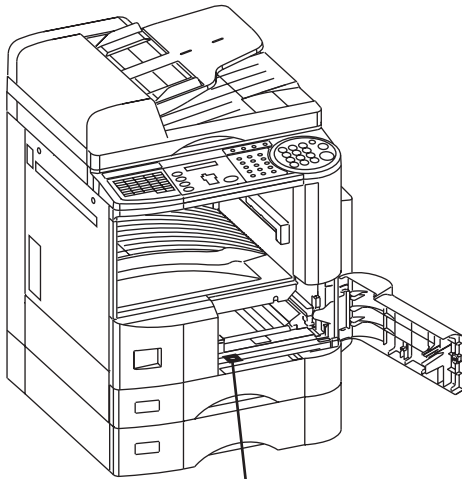

DANGER-Invisible and hazardous laser radiation when open and interlocks defeated. AVOID DIRECT EXPOSURE TO BEAM.

ATTENTION-Rayonnement laser invisible dangereux en cas d'ouverture et lorsque la sécurité est neutralisée. EXPOSITION DANGEREUSE AU FAISCEAU.

VORSICHT-Unsichtbare Laserstrahlung. wenn Abdeckung geöffnet und Sicherheitsverriegelung überbrückt. NICHT DEM STRAHL AUSSETZEN.

FBE8998A

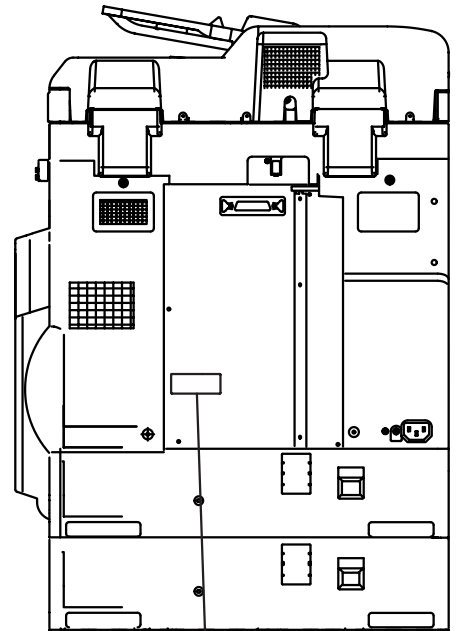

Product complies with DHHS Rules 21 CFR Subchapter J in effect at date of manufacture.

130KONJ

Matsushita Graphic Communication Systems, Inc.
2-3-8 Shimomuro, Meguro-Ku, Tokyo, Japan

MANUFACTURED : 2000

FBE8923

Handling

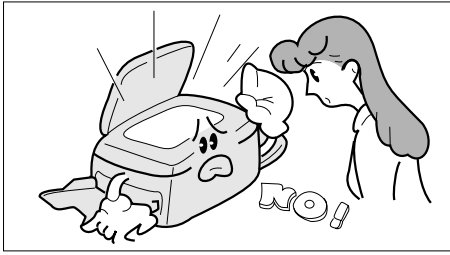

- Do not look directly at the exposure lamp when copying.

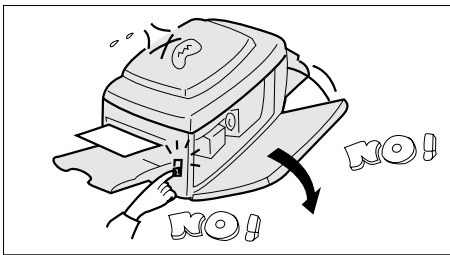

- Do not turn the power switch off or open the front panel during copying.
- Do not drop paper clips or other metal objects into the copier.

Toner and Paper

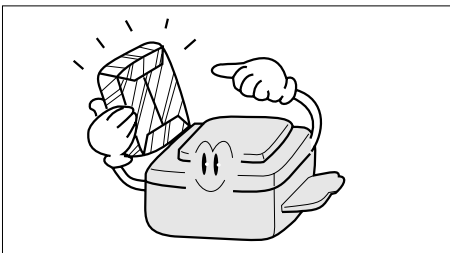

- Store toner, drum and paper in cool areas with low humidity.
- High quality paper of 16 lbs - 24 lbs (15 – 34 lbs via sheet bypass) may be used.
- For optimum performance, it is recommended that only Panasonic Brand supplies are used in the copier.

Ventilation

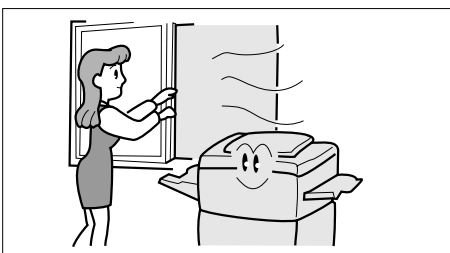

- The copier should be installed in a well-ventilated area to minimize the ozone density in the air.

Precautions

Installation

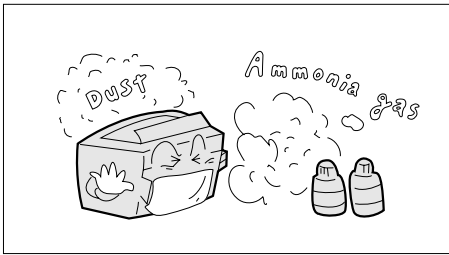
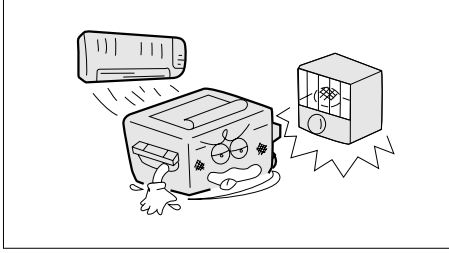

- The copier should not be installed in areas with the following conditions:
 - Extremely high or low temperature and humidity.
Ambient conditions
Temperature: 50°F – 95°F (10°C – 35°C)
Relative humidity: 45% – 85%
 - Where temperature and humidity can change rapidly, causing condensation.
 - Direct exposure to sunlight.
 - Directly in the air conditioning flow.
 - In areas of high dust concentration.
 - In areas of poor ventilation.
 - In areas with chemical fume concentration.
 - In areas with extreme vibration.
 - With unstable or uneven conditions (floors, etc.).

- The maximum power consumption is 1.5 kW.

A properly wired (grounded), dedicated, 15A, 120V AC outlet is required. Do not use an extension cord.

The main plug on this equipment must be used to disconnect the main power. Please ensure that the socket outlet is installed near the equipment and is easily accessible.

FCC WARNING For U.S.A.

FCC WARNING:

This equipment has been tested and found to comply with the limits for a Class A digital device, pursuant to part 15 of the FCC Rules. These limits are designed to provide reasonable protection against harmful interference when the equipment is operated in a commercial environment. This equipment generates, uses, and can radiate radio frequency energy and, if not installed and used in accordance with the instruction manual, may cause harmful interference to radio communications. Operation of this equipment in a residential area is likely to cause harmful interference in which case the user will be required to correct the interference at his/her own expense.

The user could lose the authority to operate this equipment if any unauthorized changes or modifications are made to this equipment.

Control Panel

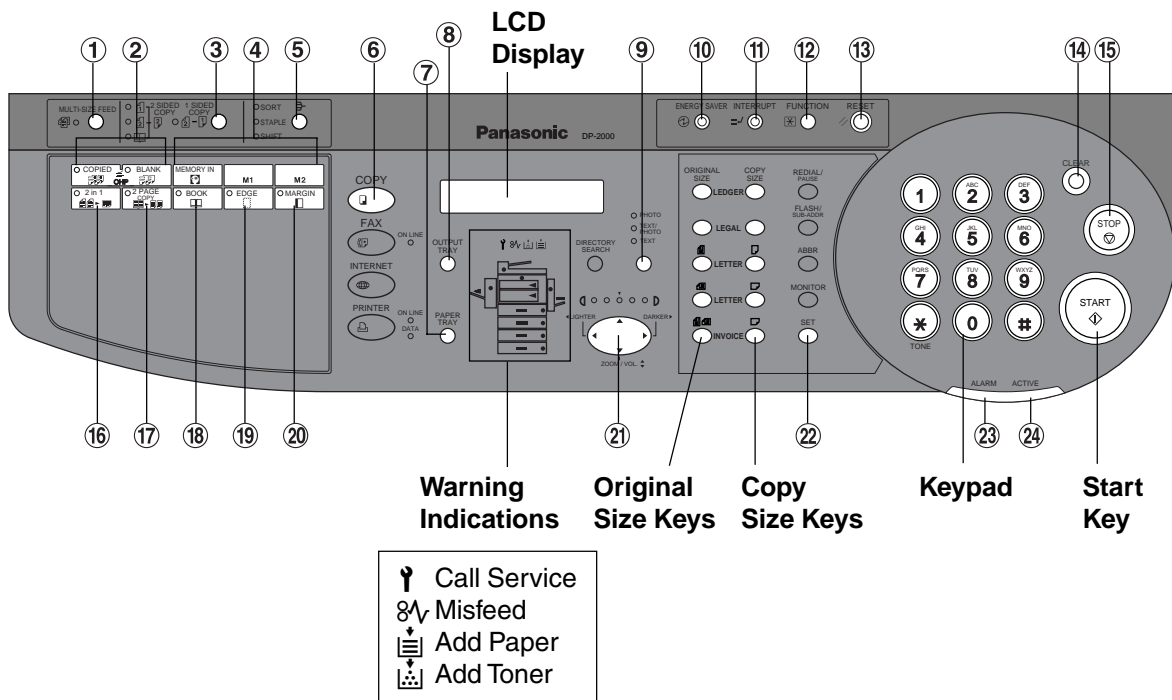

No	Contents	Refer to
①	Multi-Size Feed Key ● When Multi-sized originals are copied using ADF/i-ADF (Option).	P.40
②	OHP Interleaving Key ● Insert a paper between an OHP film.	P.22
③	2-Sided/1-Sided Copy Key ● Select a 2-Sided/1-Sided Copy function.	P.16
④	Job Memory Keys ● Use to store and recall copy jobs in memory.	P.23
⑤	Sort/Finish Key ● When sorting and stapling with the Finisher (Option).	P.41
⑥	Copy Key ● Press when using the unit as a photocopier.	—
⑦	Paper Tray Select Key	—
⑧	Output Tray Select Key	—
⑨	Original Mode Select Key (Photo; Text/Photo; Text)	P.12
⑩	Energy Saver Key ● Can save power while the copier is not in use.	P.24
⑪	Interrupt Key ● Interrupts other copy or print jobs while making copies.	P.24

NOTE

● The Control Panel displayed above shows only copier functions. Please refer to the proper operating instructions for Facsimile/Internet/Printer control panel functions.
(Refer to page 13 for details on the Original Size/Copy Size Keys.)

Control Panel

No	Contents	Refer to
⑫	Function Key <ul style="list-style-type: none">● Use when changing the paper size, initial values for functions (default values) and key operator settings.	P.28 – 37
⑬	Reset Key <ul style="list-style-type: none">● Resets all features to the initial power-on state.	—
⑭	Clear Keys <ul style="list-style-type: none">● Clears the copy count in the display.	—
⑮	Stop Key <ul style="list-style-type: none">● Stops the copy run.	—
⑯	2 in 1 Key <ul style="list-style-type: none">● From two 1-sided originals, side by side, to 1-sided copies.	P.19
⑰	2 Page Copy Key <ul style="list-style-type: none">● Copying two facing pages on a ledger size original on two separate letter size sheets.	P.20

NOTE

- The Control Panel displayed above shows only copier functions. Please refer to the proper operating instructions for Facsimile/Internet/Printer control panel functions. (Refer to page 13 for details on the Original Size/Copy Size Keys.)

No	Contents	Refer to
⑱	Book Key ● Eliminates dark inner binding shadows.	P.21
⑲	Edge Key ● Creates a blank edge.	P.21
⑳	Margin Key ● Shifts the image to the right or left.	P.21
㉑	Cursor Keys ● Select exposures (◀ or ▶) and copy ratio (▲ or ▼). Select function modes.	P.12 P.28
㉒	Set Key ● Set the present selection.	—
㉓	ALARM LED ● Lights when trouble occurs.	—
㉔	ACTIVE LED ● Lights when the machine is active.	—

NOTE

- The Control Panel displayed above shows only copier functions. Please refer to the proper operating instructions for Facsimile/Internet/Printer control panel functions.
(Refer to page 13 for details on the Original Size/Copy Size Keys.)

Basic Copy

Full Size Copying

■ Copying the Same Size Originals (1:1)

Copy size is automatically selected.

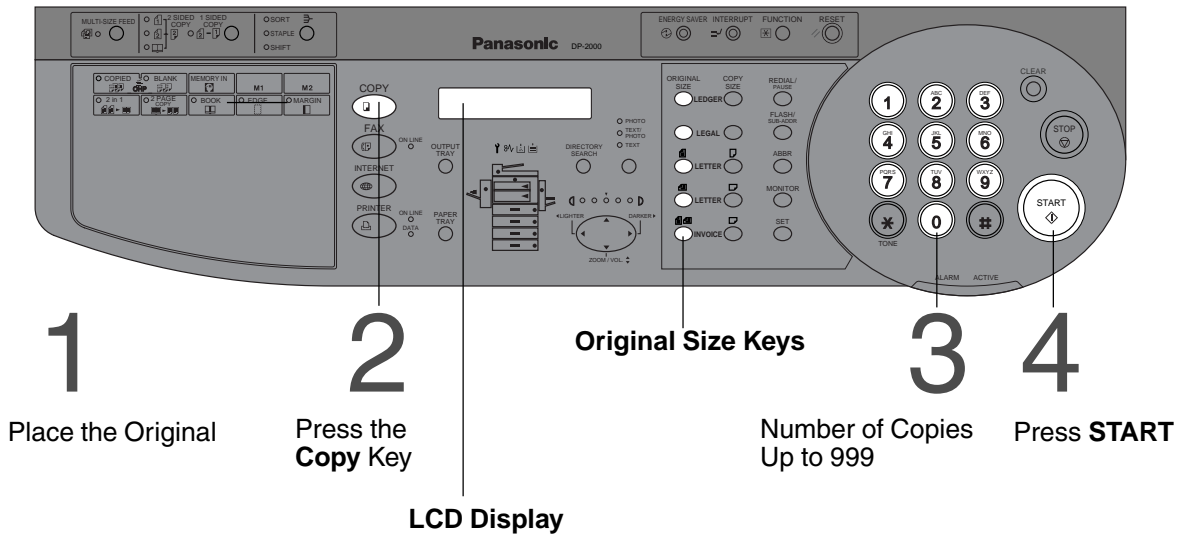

LCD Display

```
LTR [ ] -> LTR [ ] [ LTR [ ] ]
ZOOM: 100% COPIES: 001
```

(When placing Letter size originals)

■ Manually Selecting Exposure Control or Original Size

The diagram shows the control panel with a circle '1' around the 'ORIGINAL SIZE' section and a circle '2' around the 'LIGHTER' and 'DARKER' buttons.

- 1 Select the original(s)**
 Photo : Originals are mainly composed of photo.
 Text/Photo : Combined originals with text and photo.
 Text : Originals are mainly composed of text.
- 2 Select exposure control**
 Press Cursor (◀ or ▶) keys to adjust Lighter or Darker.

The diagram shows the 'ORIGINAL SIZE' and 'COPY SIZE' sections with radio buttons for LEDGER, LEGAL, LETTER, and INVOICE.

Select the original size.
 Invoice size can be switched between Portrait and Landscape mode.

Reduction or Enlargement Copying

■ Copying with Preset Ratios

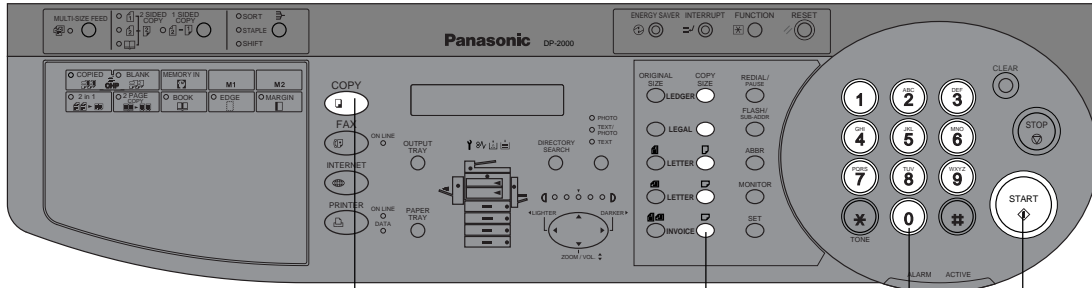

1
Place the Original

2
Press the **Copy** Key

3
Select the **Copy Size**

4
Number of Copies

5
Press **START**

Example: Reduction

Original size: LEDGER → Copy size: LETTER

LDR [] -> LTR [] [LTR []]
 ZOOM: 65% COPIES: 001

The correct ratio is automatically selected.

Reduction and enlargement ratios (%)

Original size	Copy size			
	Ledger	Legal	Letter	Invoice
Ledger	100	77	65	50
Legal	121	100	79	61
Letter	129	100	100	65
Invoice	200	155	129	100

● When changing the paper size, touch the **Paper Tray** key.

NOTE

- If the desired copy size is different from the paper size loaded in the paper tray, use sheet bypass. (See P.15)
- Press the **RESET** key to cancel the reduction or enlargement mode.

Basic Copy

Zoom Copying

■ Zoom

Copies with variable zoom ratios from 25% to 400% in 1% increments.

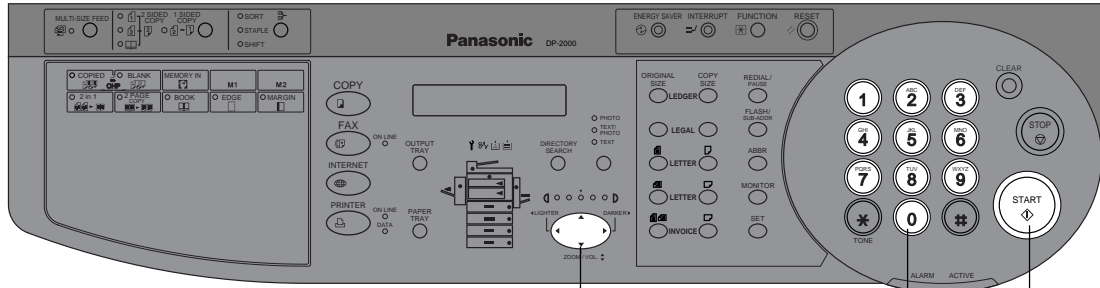

1

Place the Original

2

Press Cursor (▲ or ▼) keys to select Zoom Ratio

3

Number of Copies

4

Press **START**

LTR [] -> LTR [] [LTR []]
ZOOM: 125% COPIES: 001

(Example: 125% Zoom)

ATTENTION

- When changing the paper size after setting the zoom ratio, please use the paper tray key.

NOTE

- Press the **RESET** key to cancel the reduction or enlargement mode.

Using the Sheet Bypass

■ Copying on Special Paper, etc.

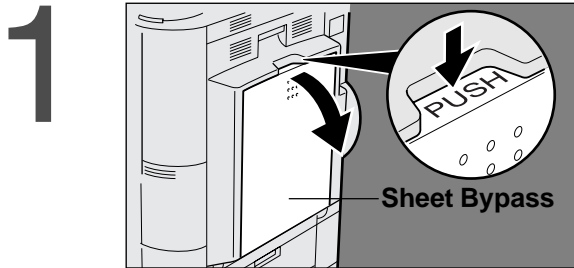

Place the original.

Open the sheet bypass.

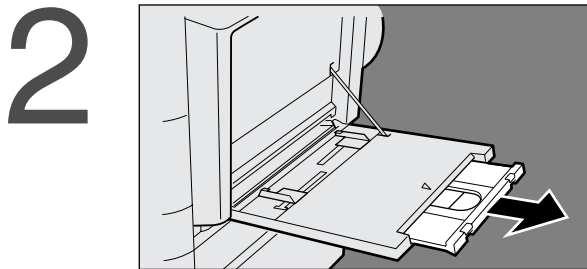

Pull out the sheet bypass tray until it stops.
(For Ledger size only)

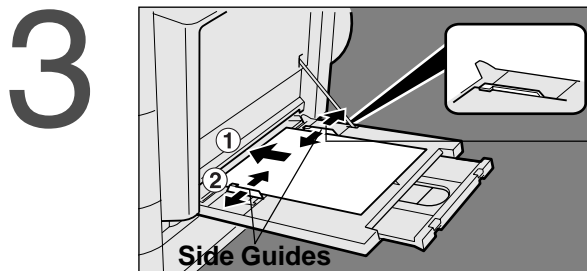

① Place approximately 50 sheets of paper into the tray.



Insert the paper until it stops.

② Adjust the side guides.

Incorrect adjustment may cause the paper to wrinkle, misfeed or skew.

Press **START**.

ATTENTION

- Do not feed curled paper through the sheet bypass to avoid misfeed.

NOTE

- Adjust the side guides properly to avoid skewing, wrinkling or misfeeding.

2-Sided/Original ▶ Copy (Duplex Copy)

2-Sided/1-Sided Copy

■ Key Operation

Press 2-Sided/1-Sided Copy key (circulation) to select a 2-Sided/1-Sided Copy function.

2-Sided/1-Sided Copy key

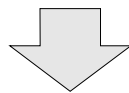
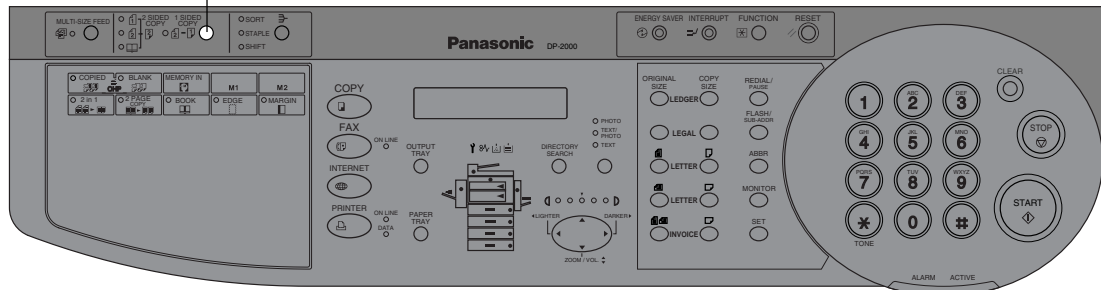

1 → 2

From 1-sided originals to 2-sided copies.

(See P.17)

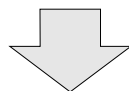

2 → 2

From 2-sided originals to 2-sided copies.

(See P.17)

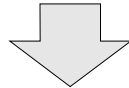

Book → 2

From book originals to 2-sided copies.

(See P.18)

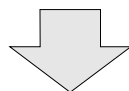

2 → 1

From 2-sided originals to 1-sided copies.

(See P.19)

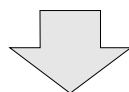

NOTE

- 2-sided originals may be handled either manually or automatically using the i-ADF (DA-AR250).
- An ADU (Automatic Duplex Unit) is required when making a 2-sided copy using an ADF (Automatic Document Feeder).

2-Sided/Original ▶ Copy (Duplex Copy)

1 → 2/2 → 1/2 → 2 Copy

■ 1 → 2 Copy

From 1-sided originals to 2-sided copies.
(From Copier Platen & i-ADF/ADF/ADU)

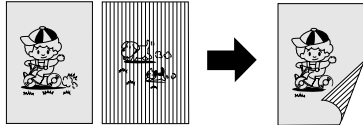

Long Edge (Binding)*

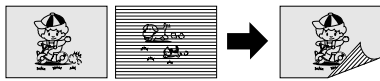

Short Edge (Binding)*

■ 2 → 1 Copy

From 2-sided originals to 1-sided copies.
(Using i-ADF)

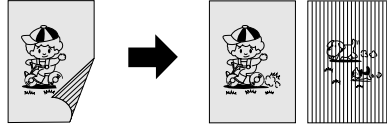

Long Edge (Binding)*



Short Edge (Binding)*

■ 2 → 2 Copy

From 2-sided originals to 2-sided copies.
(Using i-ADF/ADU)

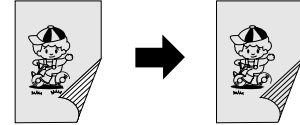

Long Edge (Binding)

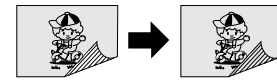

Short Edge (Binding)

■ Procedure

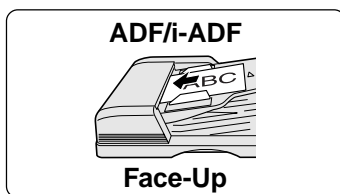

1

Place the Originals

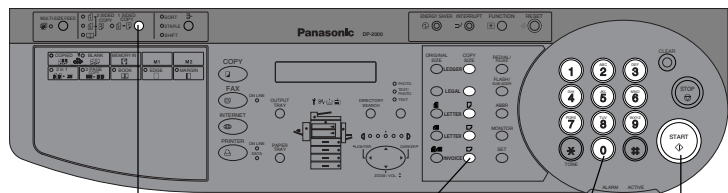

2

Press **2-Sided/1-Sided Copy** key (circulation) to select 1 → 2, 2 → 2 or 2 → 1

(3)

Copy Size (Reduction/Enlargement Only)

4

Number of Copies

5

Press **START**

BINDING: LONG EDGE
PRESS < > TO SELECT

Press the ◀ or ▶ key to select the binding location.

(When selecting 1 → 2 Copy or 2 → 1 Copy)

NOTE

● To reset each selection, press the **RESET** key.

* The initial setting of binding location for 1 → 2 Copy and 2 → 1 Copy (Long edge or Short edge) can be set in function mode. (See P.30)

2-Sided/Original ▶ Copy (Duplex Copy)

Book → 2 Copy

■ Book → 2 Copy

From book originals to 2-sided copies.
Ledger size originals only. (Using ADU)

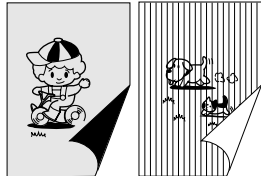
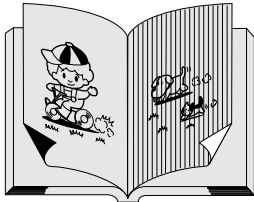

Facing (Book Format)*

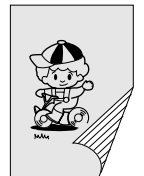
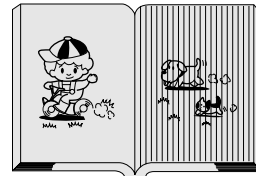

Flipping (Book Format)*

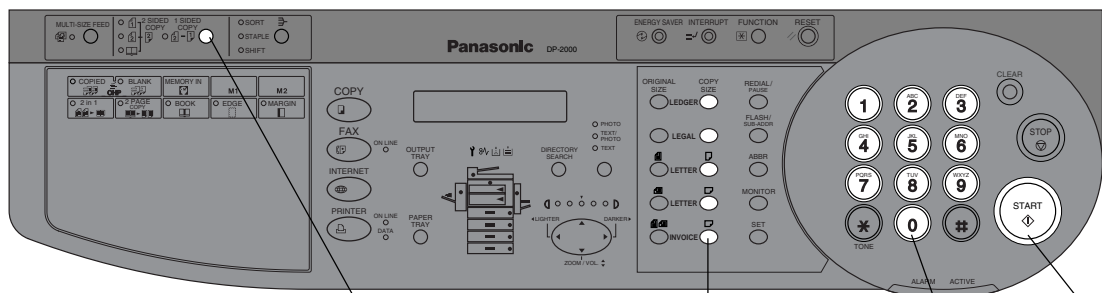

1

Place the Original on the Platen

2

Press **2-Sided/1-Sided Copy** key (circulation) to select **Book → 2**

(3)

Copy Size (Reduction/Enlargement Only*)

4

Number of Copies

5

Press **START**

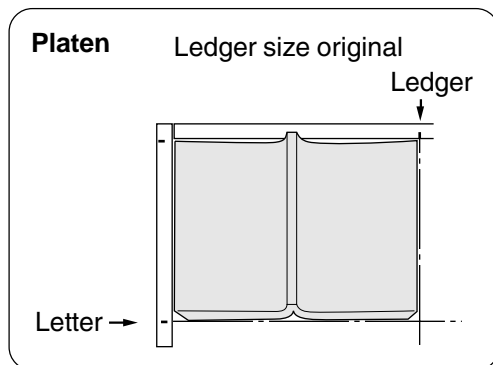
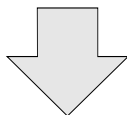

NOTE

- To reset each selection, press the **RESET** key.
- Ledger and Legal copy sizes cannot be selected.

* The book format and page order can be set in function mode. (See P.30)

2-Sided/Original ▶ Copy (Duplex Copy)

2 in 1 Copy

■ 2 in 1 Copy

From two 1-sided originals, side by side, to 1-sided pages.

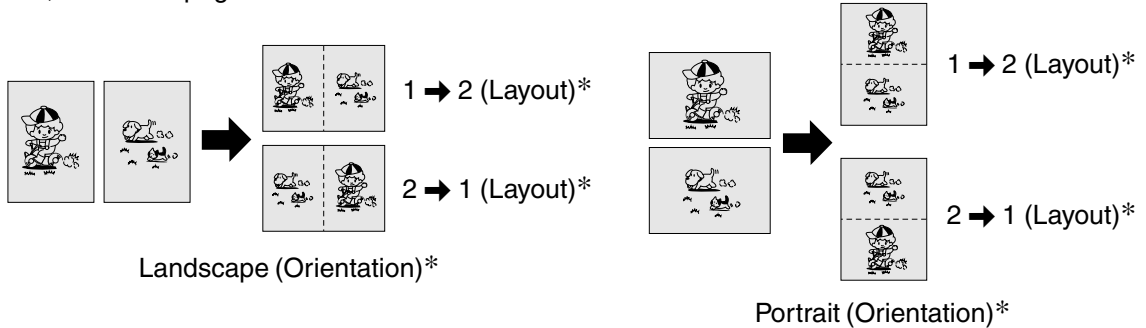

■ Procedure

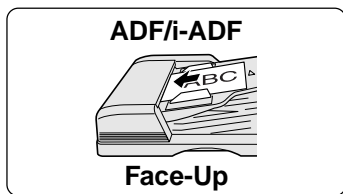

1

Place the
Originals

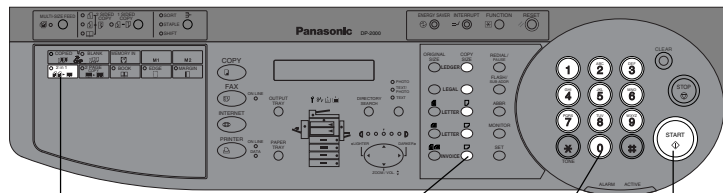

2

Press 2
in 1 key

(3)

Copy Size
(Reduction/
Enlargement Only)

4

Number of
Copies

5

Press
START

NOTE

- The ADF/i-ADF is required for 2 in 1 copy.
- To reset each selection, press the **RESET** key.

* The orientation and layout can be set in function mode. (See P.30)

2-Sided/Original ▶ Copy (Duplex Copy)

2 Page Copy

■ 2 Page Copy

Copying two facing pages on a ledger size original on two separate letter size sheets.

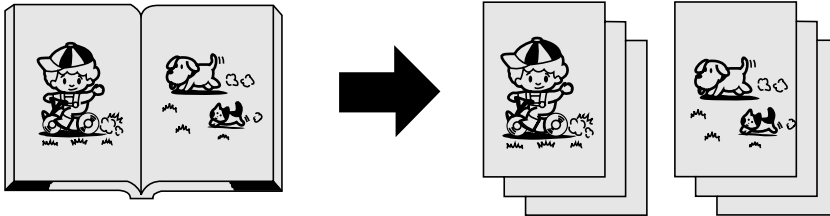

■ Procedure

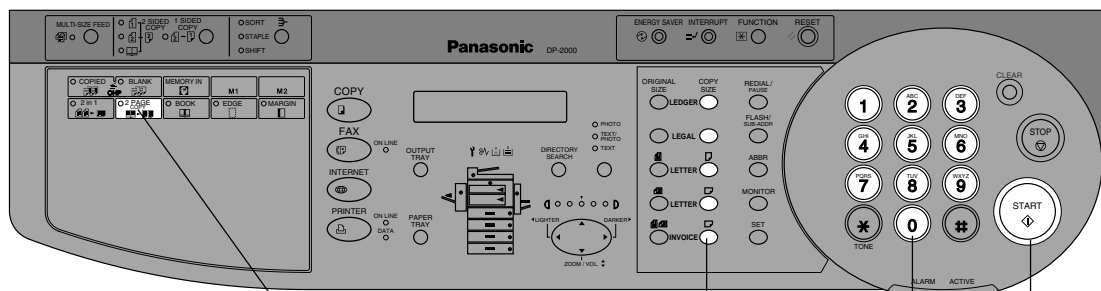

1

Place the
Originals

2

Press the **2
Page Copy**
key

(3)

Copy Size
(Reduction/
Enlargement Only)
Ledger and Legal
copy sizes cannot be
selected.

4

Number of
Copies

5

Press
START

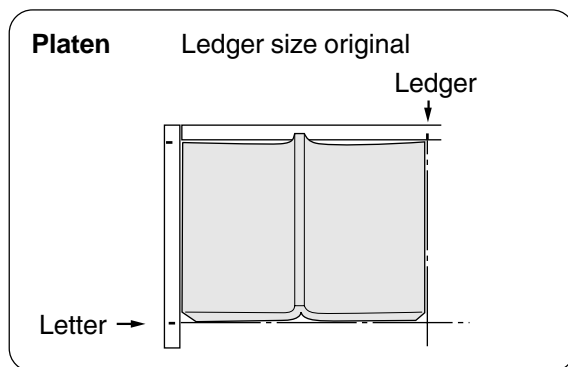
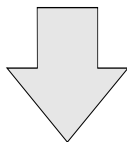

NOTE

- To reset each selection, press the **RESET** key.

Margin

Book/Edge/Margin

- **Book Key**
Eliminates dark inner binding shadows when copying from a book.
- **Edge Key**
Creates a blank edge.
- **Margin Key**
Shifts the image to the right or left.

■ Procedure

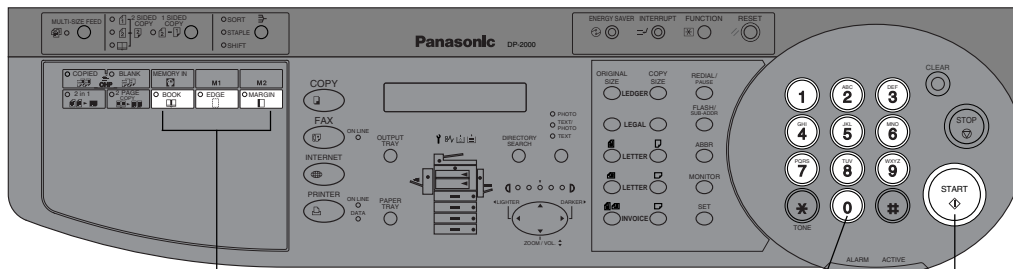

- 1** Place the Original
- 2** Press Book, Edge or Margin key
- 3** Number of Copies
- 4** Press **START**

Book

BOOK MARGIN
CENTER VOID = 20mm ∨∧

- ① Press the Cursor (▲ or ▼) keys to adjust the void width. (5-99 mm)
- * Initial setting (Factory setting): 20 mm

Edge

EQUAL RATE
VOID MARGIN = 5mm ∧

- ① Press the Cursor (▲ or ▼) keys to adjust the void width. (5-99 mm)
- * Initial setting (Factory setting): 5 mm and Equal Rate

Margin**

LEFT MARGIN
10mm ∨∧

- ① Press the Cursor (▲ or ▼) keys to adjust the margin width. (5-99 mm)
- * Initial setting (Factory setting): 10 mm and Left Margin

NOTE

- * Initial setting (Factory setting) can be changed in the User Mode function. (See Page 30)
- ** If a part of the copied image is missing when using the Margin mode, change the Frame Reduction setting to ON. (See Page 30)
- To reset each selection, press the **RESET** key.

Insertion Copy

OHP Interleaving

■ OHP Interleaving

Inserts paper between the OHP film.

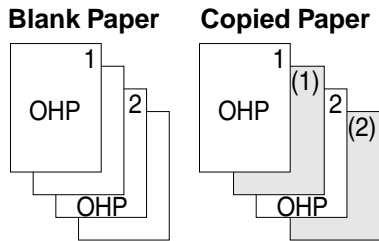

■ Procedure

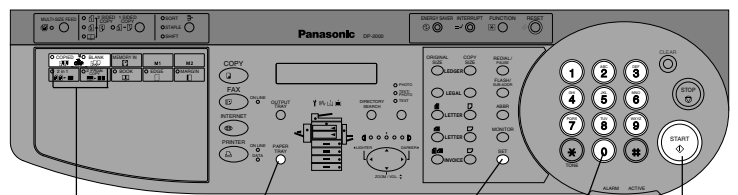
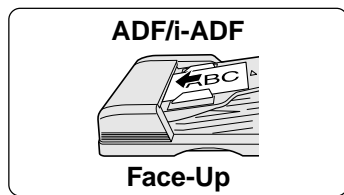

1

Place the OHP Sheet
(Sheet Bypass)

2

Place the Originals

3

Press the **Copied** key or the **Blank** key

4

Press **Paper Tray** key to select the Inserts Paper

5

Press the **SET** key

6

Number of Copies

7

Press **START**

NOTE

- To reset each selection, press the **RESET** key.
- The i-ADF/ADF is required for the OHP Interleaving function.

Job Memory

- Two Copy Jobs Can Be Programmed in Memory (M1 M2) for recall at a later time.

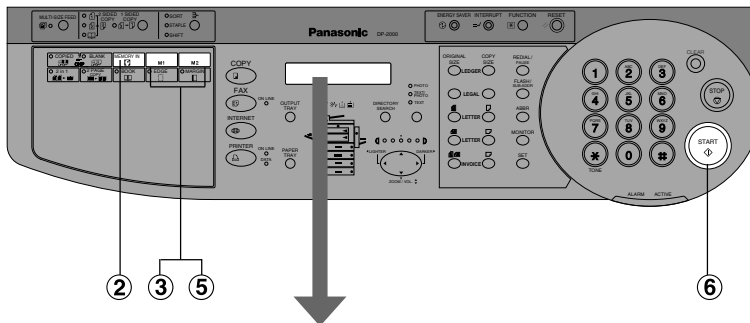

JOB MEMORY
PRESS M1, M2 TO STORE

To store a job in memory

- ① Set up the copy job to be stored in memory, by first selecting each function you wish the copier to perform.
- ② Press the **Memory In** key.
- ③ Press the **M1** or **M2** key.

RECALL JOB MEMORY
LOADING...

To recall a job stored in memory

- ④ Place the Original
- ⑤ Press the **M1** or **M2** key.
The stored contents will be displayed.
- ⑥ Press **START**

NOTE

- Job memory mode will not be deleted even if the power switch is turned off.
- When storing a new job into programmed memory, the previously stored job will be overwritten and erased.

Other Features

Energy Saver/Interrupt Mode

Energy Saver Key Interrupt Key

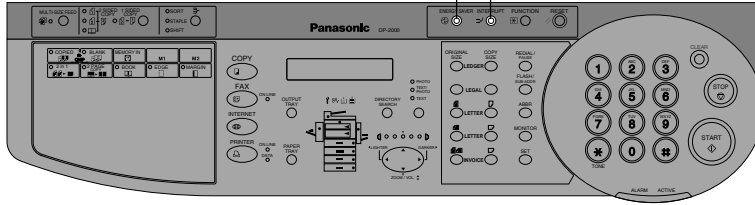

ENERGY SAVER

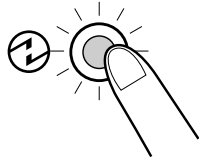

■ These modes can save power while the copier is not in use.

Energy Saver Mode

- ① To enter this mode
Press the **Energy Saver** key or the copier will automatically enter the Energy Saver Mode after 15 minutes from the last copy. The indicator will flash.
- ② To cancel this mode and make copies
Press the **Energy Saver** key again.

Sleep Mode

- ① Automatically enters the Sleep Mode after 30 minutes from the last copy. The copier power will drop and the indicator will light.
- ② To make copies, press the Energy Saver key.

INTERRUPT

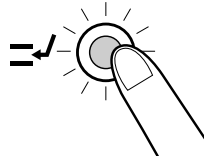

Interrupt Mode

● This mode can interrupt other copy jobs while making copies.

- ① Press the **Interrupt** key, the indicator will light.
- ② Make another copy job using the platen glass.
- ③ Press the **Interrupt** key again to continue the original job.

Note: The ADF/iADF can not be used with interrupt.
(Use only the Platen)

NOTE

- Energy saver time (15 minutes) and Sleep time (60 minutes) can be changed by the key operator. (See Page 31)

Modes	Power Consumption	Warm Up Time
Normal Operation	Approximately 145 Wh	N/A
Energy Saver Mode	Approximately 49 Wh	30 sec. recovery
Sleep Mode	Approximately 1.8 Wh	35 sec. recovery

Skyshot Mode

- When copying from the platen with the platen cover or ADF/iADF open, two types of Skyshot modes can be selected.

Manual Skyshot Mode: Making copies from small originals without dark areas around the image.

Digital Skyshot Mode : Making copies by detecting the skyshot area.

- Setting the Digital Skyshot Mode

1

Press the Function Key

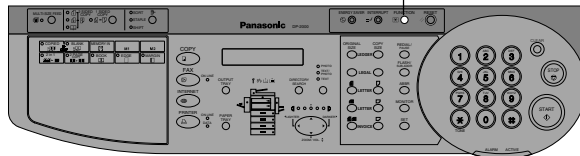

2

Proceed as Follows:

```
FUNCTION MODE (1-2)
ENTER NO. OR ∨ ∧
```

```
2:COPIER SETTINGS
PRESS SET TO SELECT
```

```
COPIER PARAM. (00-14)
ENTER NO. OR ∨ ∧
```

```
06 DIGITAL SKYSHOT
2:NORMAL
```

- ① Press the **2** key to select COPIER SETTINGS.
- ② Press the **SET** key.
- ③ Press **6** and **SET** key to select DIGITAL SKYSHOT.
- ④ Press **1-3** key to select the Digital Skyshot Mode.
 - 1: OFF NONE
 - 2: NORMAL The copying process is carried out while the Skyshot area is being detected.
 - 3: QUALITY If the machine is under fluorescent lighting, the Skyshot area may not be detected correctly and the copy quality may be affected. If this happens, select "Quality" for the Digital Skyshot Mode.
- ⑤ Press the **SET** key.

NOTE

- An incorrect exposure may occur when there is a black line at the edge of the original or an image which the copier interprets as a black pattern in the Skyshot mode.
- An incorrect position detection of the original may occur when a strong light shines onto the glass during Skyshot mode.

Other Features

Skyshot Mode

■ Copying with the Manual Skyshot Mode

- Set Manual Skyshot mode first.

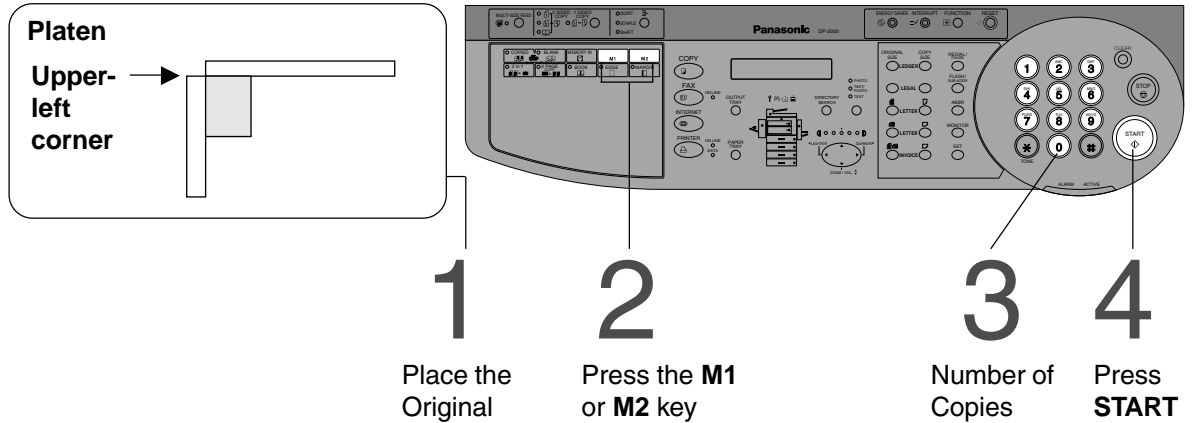

■ Setting the Manual Skyshot Mode

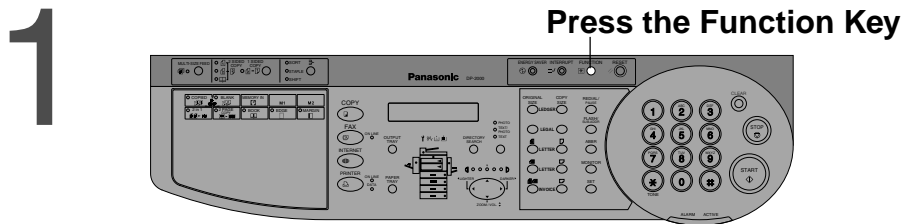

2 Proceed as Follows:

```
FUNCTION MODE (1-2)
ENTER NO. OR v ^
```

```
2: COPIER SETTINGS
PRESS SET TO SELECT
```

```
COPIER PARAM. (00-14)
ENTER NO. OR v ^
```

```
07 MANUAL SKYSHOT
2: M1 ON
```

- ① Press the 2 key to select COPIER SETTINGS.
- ② Press the SET key.
- ③ Press 7 and SET key to select MANUAL SKYSHOT.
- ④ Press 1-4 key to select the Manual Skyshot Mode.
 - 1: OFF NONE
 - 2: M1 ON M1 size is ON
 - 3: M2 ON M2 size is ON
 - 4: M1, M2 ON Both sizes are ON
- ⑤ Press the SET key.

NOTE

- When changing the M1 or M2 size, consult with the key operator.
- When using the manual skyshot mode, M1 and M2 are turned ON and other job memory cannot be used.
- To reset the manual skyshot mode, press the RESET key.

Combined Function Table

Next Selections	First Selections	2-SIDED/ORIG. COPY						Margin			SORT						Other Functions						Remarks			
		Zoom Copy	1 → 2 Copy	2 → 1 Copy	2 → 2 Copy	Book → 2 Copy	2 in 1 Copy	2 Page Copy	Book	Edge	Margin	Non-Sort	Sort	Sort-Rotate	Shift-Sort	Shift-Group	Staple-Sort	OHP Interleaving	Multi-Size Feeding	Manual Skyshot	Inner Output	Outer Output		Job Memory Retrieval	Job Memory Storing	
Zoom Copy		A	O	O	O	O	O	O	O	O	O	O	O	O	O	O	O	O	O	O	O	O	O	O	O	
2-SIDED/ORIG. COPY	1 → 2 Copy	O	A	A	A	A	O	A	O	O	O	O	O	O	O	O	O	X	X	A	O	O	A	O		
	2 → 1 Copy	O	A	A	A	A	O	A	O	O	O	O	O	O	O	O	O	X	X	A	O	O	A	O		
	2 → 2 Copy	O	A	A	A	A	O	A	O	O	O	O	O	O	O	O	O	X	X	A	O	O	A	O		
	Book → 2 Copy	O	A	A	A	A	O	A	O	O	O	O	O	O	O	O	O	X	X	A	O	O	A	O		
	2 in 1 Copy	O	O	A	A	A	O	A	O	O	O	O	O	O	O	O	O	X	X	A	O	O	A	O		
	2 Page Copy	O	A	A	A	A	O	A	O	O	O	O	O	O	O	O	O	X	X	A	O	O	A	O		
Margin	Book	O	O	O	O	O	O	A	O	O	O	O	O	O	O	O	O	O	O	A	O	O	A	O		
	Edge	O	O	O	O	O	O	O	A	O	O	O	O	O	O	O	O	O	O	A	O	O	A	O		
	Margin	O	O	O	O	O	O	O	O	A	O	O	O	O	O	O	O	O	O	A	O	O	A	O		
SORT	Non-Sort	O	O	O	O	O	O	O	O	O	A	A	A	A	A	A	A	O	O	A	O	O	A	O		
	Sort	O	O	O	O	O	O	O	O	O	A	A	A	A	A	A	A	O	O	A	O	O	A	O		
	Sort-Rotate	O	O	O	O	O	O	O	O	O	A	A	A	A	A	A	A	O	O	A	O	O	A	O		
	Shift-Sort	O	O	O	O	O	O	O	O	O	A	A	A	A	A	A	A	O	O	A	O	O	A	O		
	Shift-Group	O	O	O	O	O	O	O	O	O	A	A	A	A	A	A	A	O	O	A	O	O	A	O		
	Staple-Sort	O	O	O	O	O	O	O	O	O	A	A	A	A	A	A	A	X	A	A	O	O	A	O		
Other Functions	OHP Interleaving	O	X	O	X	X	X	X	O	O	O	-	-	-	-	-	-	A	X	A	O	O	A	O		
	Multi-Size Feeding	O	A	A	A	A	A	A	O	O	O	O	O	O	O	O	X	A	A	O	O	A	O			
	Manual Skyshot	O	X	X	X	X	X	X	O	O	O	-	-	-	-	-	-	X	X	A	O	O	A	X		
	Inner Output	O	O	O	O	O	O	O	O	O	O	O	O	O	A	A	A	O	O	O	A	A	A	O		
	Outer Output	O	O	O	O	O	O	O	O	O	O	O	O	O	O	O	O	O	O	O	A	A	A	O		
Interrupt	O	X	X	X	X	X	O	O	O	O	-	-	-	-	-	-	X	X	X	X	X	X	X			

O: Possible Combined Functions.

X: Unavailable Combined Functions.

A: Next Selection is Carried Out.

-: Indicates that SORT mode cannot be used. Non-sort operation is carried out.

Function

■ Using Function Modes to Change the Initial Copy Modes

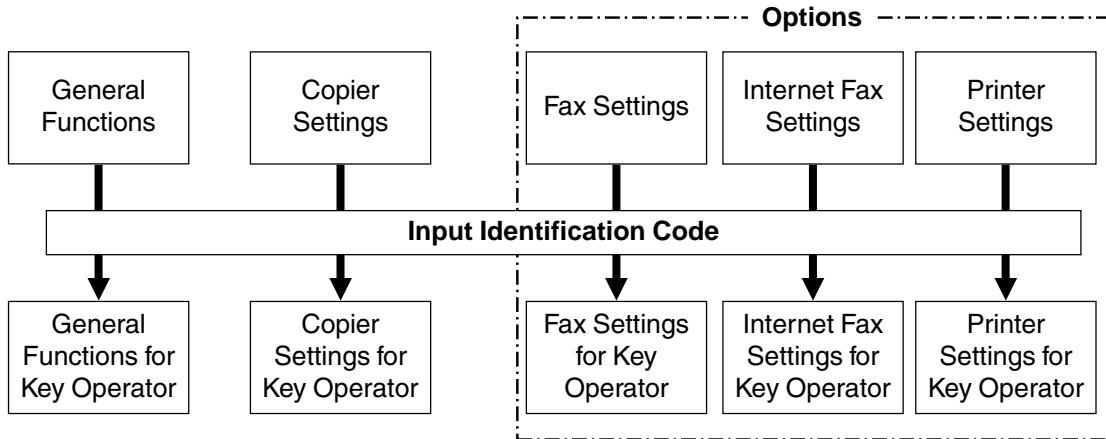

■ Procedure

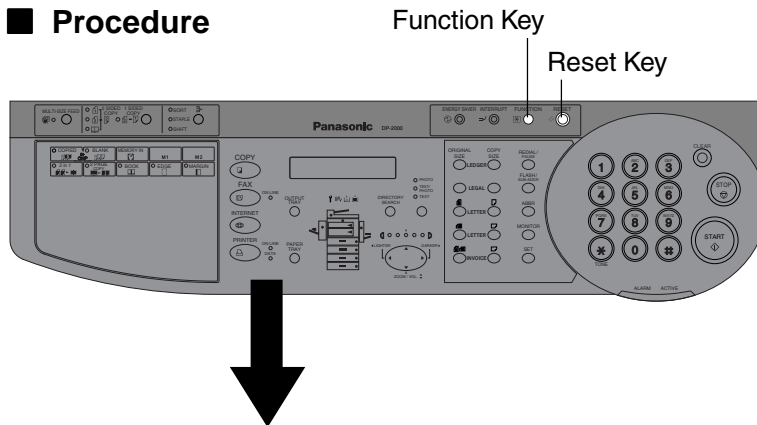

FUNCTION MODE (1-2)
ENTER NO. OR ∨ ^

- ① Press the **Function Key**
- ② Press **1** (GENERAL FUNCTIONS) or **2** (COPIER SETTINGS) key.
- ③ Press the **SET** key.
- ④ Press the **Keypad** to select function modes.
- ⑤ Follow the on screen instructions.
- ⑥ After setting, press the **SET** key to set up the function

NOTE

- Please refer to each options operating instructions for function settings.

General Functions

No.	Modes	Function	Initial Setting
00	SORT MODE DEFAULT	Selects the finisher mode. ● Non-Sort, Sort, Staple-Sort, Shift-Sort, Shift-Group	Non-Sort
02	POWER ON DEFAULT	* Selects mode. ● Copy, Fax	Copy
05	SORT MEMORY USAGE	Displays the amount of sort memory used on the panel. ● OFF, ON	OFF
06	DEPT. COUNTER	Copy usage and copy limit of the selected department and total copy usage will appear on the screen.	Consult your service technician.
08	SORT-ROTATE	Select Sort-Rotate mode. ● OFF, ON	OFF
09	KEY OPERATOR MODE	Input the key operator ID code.	

NOTE

* Not needed in copying mode, but needed when installing options for advanced functions (see page 61) or using multi functions model.

Function

Copier Settings

No.	Modes	Function	Initial Setting
00	MARGIN DEF.	Selects the margin position and shift value. ● Left, Right, Top, Bottom ● 5 - 99 mm	Left 10 mm
01	EDGE DEF.	Selects the edge mode (equal rate or individual rate) and width. ● Equal rate, Individual rate (Vertical and Horizontal) ● 5 - 99 mm	Equal rate 5 mm
02	BOOK MARGIN DEF.	Selects the book void width. ● 5 - 99 mm	20 mm
03	FRAME MARGIN	Selects the reduction ratio in margin mode. ● OFF, ON	OFF
04	2-SIDED MODE DEF.	Function sets the duplex priority mode. ● 1 → 2, 2 → 2, Book → 2	NO
05	N in 1 WITH FRAME	Selects whether or not to disable edge deletion. ● OFF, ON	OFF
06	DIGITAL SKYSHOT	Enables or disables the use of skyshot mode. ● OFF, Normal, Quality	Normal
07	MANUAL SKYSHOT	Enables or disables the use of Manual Skyshot. ● OFF, M1 ON, M2 ON, M1&M2 ON	OFF
08	AUTO EXPOSURE	Automatically adjusts the copy density for text and photographic originals. ● OFF, ON	ON
09	1 → 2 BINDING DEF.	Selects the binding location for 1 → 2 Copy. ● Long edge, Short edge	Long edge
10	2 → 1 BINDING DEF.	Selects the binding location for 2 → 1 Copy. ● Long edge, Short edge	Long edge
11	BOOK → 2 DEF.	Selects the page order and book format for Book → 2 Copy. ● L → R, R → L (Page order) ● Facing, Flipping (Book format)	L → R Flipping
12	2 in 1 DEF.	Selects the orientation and layout for 2 in 1 Copy. ● Portrait, Landscape (Orientation) ● L → R, R → L (Layout)	Portrait L → R
13	2 PAGE MODE DEF.	Selects the 2 page mode. ● L → R, R → L	L → R
14	KEY OPERATOR MODE	Input key operator ID code.	

General Functions for Key Operator

No.	Modes	Function	Initial Setting
00	PAPER SIZE	Sets the paper size of each paper tray.* ● Tray-1, Tray-2, Tray-3, Tray-4	Consult your service technician.
01	AUTO RESET TIME	Selects the Control Panel reset time. ● None, 30 seconds, 1 minute, 2 minutes, 3 minutes, 4 minutes	1 minute
02	ENERGY SAVER MODE	Sets the Energy Saver mode and time. ● None, Energy save mode, Sleep mode Energy save mode timer : 1-120 minutes Sleep mode timer : 1-120 minutes	Sleep
03	ENERGY SAVER TIME	Sets the on time and off time for Energy Saver mode. ● Start time - End time	
04	LANGUAGE DEFAULT	Selects the message language of the display. ● English, French, Spanish	English
05	SPECIAL TRAY 1	Sets the paper tray for special paper (ex: colored). ● None, Tray-1, Tray-2, Tray-3, Tray-4, Sheet Bypass	NONE
06	SPECIAL TRAY 2	Sets the paper tray for special paper (ex: colored). ● None, Tray-1, Tray-2, Tray-3, Tray-4, Sheet Bypass	NONE
09	KEY/TOUCH BEEP	Sets the panel touch sound. ● Off, Soft, Loud	Soft
10	ORIG. SET BEEP	Beep sound when original is set on the platen. ● OFF, ON	OFF
11	ORIG. SET BEEP ADF On	Beep sound when original is set in the ADF. ● OFF, ON	ON
14	DEPT. COUNTER MODE	Monitors copy usage of each department. (1) Copy usage of each department (2) Copy limit of each department (3) Copy number of each department	Consult your service technician.
20	DATE & TIME	Sets the date & time	
21	DAYLIGHT TIME	Sets daylight saving time ● OFF, ON	ON
22	TCP/IP ADDRESS	* Sets user IP address ● 3 digit × 4	
23	TCP/IP SUBNET MSK	* Sets the subnet mask ● 3 digit × 4	
24	TCP/IP G/W ADDR.	* Sets the gateway address ● 3 digit × 4	

NOTE

- It is necessary to input the Key Operator ID code before changing items on this page.
- The Special Tray 1 and 2 are not auto-selectable in the switching mode.
- * Not needed in copying mode, but needed when installing options for advanced functions (see page 61) or using multi functions model.

Function

Copier Settings for Key Operator

No.	Modes	Function	Initial Setting
00	PAPER SIZE PRIOR.	Specifies the paper size in manual paper size setting mode.	Letter
01	ORIGINAL (HOME)	Selects original setting ● Text, Text/Photo, Photo	Text/Photo
02	TEXT CONTRAST	Selects contrast for Text mode ● 1 ~ 5	3
03	T/P CONTRAST	Selects contrast for Text/Photo mode ● 1 ~ 5	3
04	PHOTO CONTRAST	Selects contrast for Photo mode ● 1 ~ 5	3
10	MAX. COPY SETTING	Determines whether to limit number of copies ● 0 (No limit) ~ 999	0 (No limit)
11	MULTI-SIZE ROTATE	When using the same size paper in Multi-size feeding mode, select the paper direction by rotating or not. ● INVALID, VALID	VALID
12	M1, SIZE	Input a size in memory 1 for frequent usage size. ● X: 5~432/Y: 5~297 mm (See P.26)	70 × 160 mm (X) (Y)
13	M2, SIZE	Input a size in memory 2 for frequent usage size. ● X: 5~432/Y: 5~297 mm (See P.26)	95 × 220 mm (X) (Y)
16	MEM. FULL ACTION	Selects the memory full action ● Print, Cancel	Print
18	COPY OUTPUT TRAY	* Sets the stack position for the copied paper. ● Inner 1, Inner 2, Outer	Inner 1

NOTE

● It is necessary to input the Key Operator ID code before changing items on this page.

* Not needed in copying mode, but needed when installing options for advanced functions (see page 38).

Function Setting

■ Changing the Auto Exposure Setting

You can select whether the copying density is adjusted automatically for text and photographic originals.

1

Press the Function Key

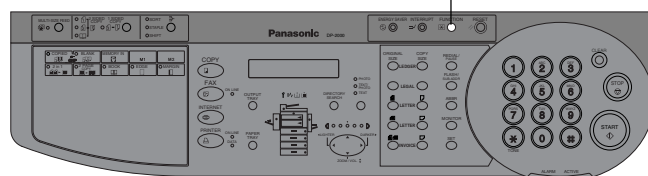

2

Proceed as Follows:

```
FUNCTION MODE (1-2)
ENTER NO. OR ∨ ∧
```

```
2:COPIER SETTINGS
PRESS SET TO SELECT
```

```
COPIER PARAM. (00-14)
ENTER NO. OR ∨ ∧
```

```
08 AUTO EXPOSURE
2:VALID
```

- ① Press the **2** key to select COPIER SETTINGS.
- ② Press the **SET** key.
- ③ Press **8** and **SET** key to select AUTO EXPOSURE MODE.
- ④ Press **1** or **2** key whether Auto Exposure is to be carried out or not.
- ⑤ Press the **SET** key to set up the AUTO EXPOSURE MODE.
- ⑥ Press the **RESET** key to exit the Function mode.

Function

Function Setting for Key Operator

■ Changing the Paper Size

The paper trays are designed to accommodate invoice, letter, letter R, legal and ledger size paper. To change the paper size, perform the steps shown below.

1

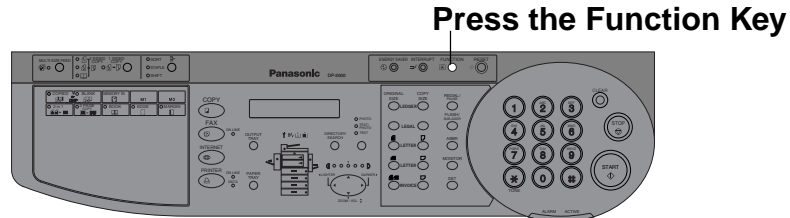

2

Proceed as Follows:

```
FUNCTION MODE (1-2)
ENTER NO. OR v ^
```

- ① Press the **1** key to select GENERAL FUNCTIONS.

```
1:GENERAL FUNCTIONS
PRESS SET TO SELECT
```

- ② Press the **SET** key.

```
GENERAL PARAM. (0-9)
ENTER NO. OR v ^
```

- ③ Press **9** key.

```
09 KEY OPERATOR MODE
ENTER PASSWORD=■■■
```

- ④ Input the Key Operator ID code (3 digit) and the **SET** key.

```
KEY OPR. MODE (00-24)
ENTER NO. OR v ^
```

- ⑤ Press **00** and the **SET** key to select the PAPER SIZE.

```
00 PAPER SIZE
1:TRAY-1[LTR]
```

- ⑥ Press **1-4** to select the paper tray and press **▲** or **▼** keys to set paper size. Paper size changes are as follows.

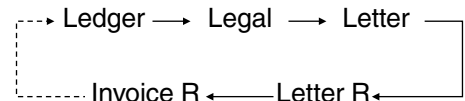

- ⑦ Press the **SET** key to set up the PAPER SIZE.

- ⑧ Press the **RESET** key, then exit the Function mode.

3 Changing the Paper Guide and Paper Size Indicator in the Paper Tray

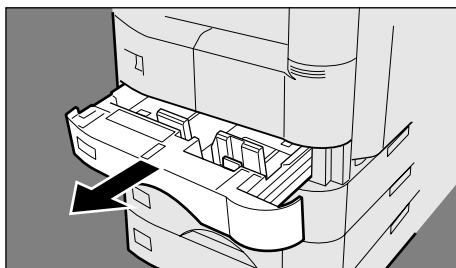

① Pull out paper tray and remove paper.

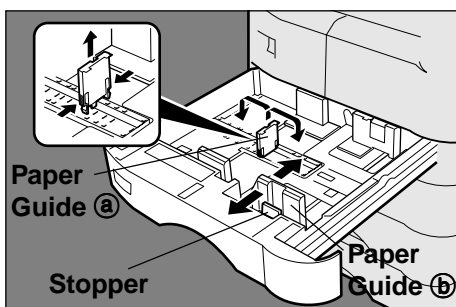

② Move the paper guide (a) to the paper length required.

③ Move the paper guide (b) to the paper width required.
Pinch the stopper to move the paper guide (b).

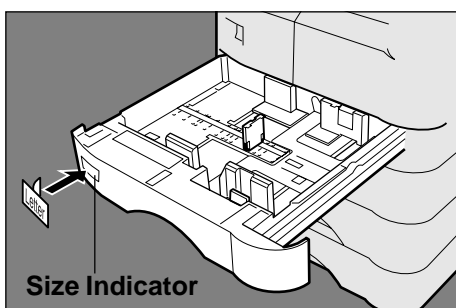

④ Change the paper size indicator.

⑤ Close the paper tray.

NOTE

- It is recommended that the paper guide (b) be fixed in place with screws. Consult an authorized servicing dealer for details on how to fasten using screws.

Function

Function Setting for Key Operator

■ Departmental Counter

The Key operator can manage, limit copies, counters and code numbers for each department.
(Maximum department number: 50)

1

Press the Function Key

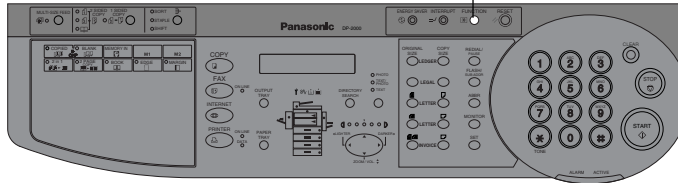

2

Proceed as Follows:

```
FUNCTION MODE (1-2)
ENTER NO. OR v ^
```

- ① Press the **1** key to select GENERAL FUNCTIONS.

```
1:GENERAL FUNCTIONS
PRESS SET TO SELECT
```

- ② Press the **SET** key.

```
GENERAL PARAM. (0-9)
ENTER NO. OR v ^
```

- ③ Press **9** key.

```
09 KEY OPERATOR MODE
ENTER PASSWORD=■■■
```

- ④ Press the Key Operator ID code (3 digit) and **SET** key.

```
KEY OPR. MODE (00-24)
ENTER NO. OR v ^
```

- ⑤ Press **14** and the **SET** key to select DEPT. COUNTER MODE.

NOTE

- To reset the function mode, press the **RESET** key.
- Contact your authorized servicing dealer to enable the Departmental Counter feature.

3

Change the Department Counter number, limit the maximum number of copies and Department ID Code.

```
14 DEPT.COUNTER MODE
1:TOTAL COUNTER
```

```
DEPT. CODE (01-50)
ENTER NO. OR v ^
```

```
DEPT. COUNTER
01:123456
```

```
MAX COPIES
01:123456
```

```
I.D CODE
01:1234
```

⑥ Press **2** and the **SET** key.

⑦ Press the **Keypad** and the **SET** key (or **▲ ▼** keys) to select the Department No.

```
01: 123456 ← Counter (6 digits)
↑
Department No.
```

⑧ Press **0** and the **SET** key (Input "0") to clear the counter.

```
01: 123456 ← Maximun number of copies (6 digits)
↑
Department No.
```

⑨ Press the **Keypad** and the **SET** key to input the maximum number of copies.

```
01: 1234 ← Department ID Code
↑
Department No.
```

⑩ Press the **Keypad** and the **SET** key to input the Department ID Code.

⑪ Press the **RESET** to exit the Function mode.

NOTE

- To reset the function mode, press the **RESET** key.

Accessories

Components

1-Bin Finisher (or) Exit Tray (Outer)
(DA-FS200) (DA-XT200)

- Large capacity (Max. 1000 copies)

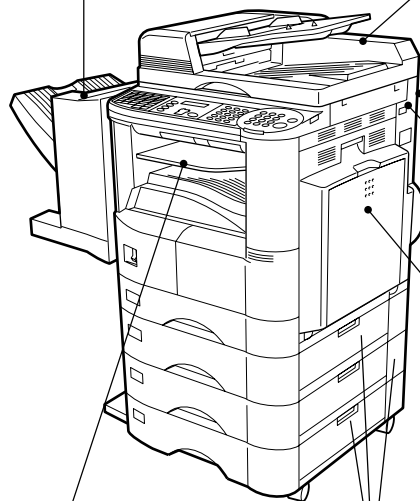

ADF, Automatic Document Feeder
(DA-AS200)

- Feeds originals automatically.
- For 2 in 1 copying.
- Multi-size feeding.

i-ADF, Inverting Automatic Document Feeder
(DA-AR250)

- Feeds originals automatically.
- For 2 in 1 copying.
- Multi-size feeding.
- For duplex copying.

Electronic Sorting Board
(DA-ES200)

- For sorting copies electronically
- 8 MB memory built-in

Image Memory
(DA-SM08B/16B/28B)

- 8/16/128 MB
- To increase the memory capacity for electronic sorting.

ADU, Automatic Duplex Unit
(DA-MD200)

- For duplex copying.

Dual-Path Exit Guide Unit/Paper Transport Unit
(DA-FK200/FK210)

- Required when the 1-Bin Finisher/ADU is installed

Exit Tray (Inner)
(DA-XN200)

2nd/3rd/4th Paper Feed Module
(DA-DS210/DS200)

- To increase the paper feed sources and capacity.
Storage Drawer × 3 (550 sheets)

NOTE

- The table below shows the options which are required for various functions.
- Contact your authorized servicing dealer for details on combinations of options.

Function \ Options	2-SIDED/ORIG. ► COPY				Margin			SORT					Other Functions					
	Zoom Copy	1 ↑ 2 Copy	2 ↑ 1 Copy	2 ↑ 2 Copy	Book	Edge	Margin	Non-Sort	Sort	Sort-Rotate	Shift-Sort	Shift-Group	Staple-Sort	OHP Interleaving	Multi-Size Feeding	Manual Skyshot	Inner Output	Outer Output
i-ADF			○	○										●	●			
ADF																		
ADU	○			○														
Electronic Sorting Board									○	○	○	○	○					
1-Bin Finisher																		●
Exit Tray (Outer)																		
Exit Tray (Inner)																	○	
Paper Transport Unit	○			○														○
Dual-Path Exit Guide Unit	○			○														○
2nd Paper Feed Module										○								

○:Required ●:Either one required

Automatic Document Feeder

■ ADF (DA-AS200)/i-ADF (DA-AR250)

1. Features

① Automatic Original Feeding

- The ADF/i-ADF tray can hold up to 50 originals of 20 lbs paper. (30 originals/legal, ledger)
It can accommodate originals from invoice to ledger size.
- Automatic original size detection.

② Duplex Copying (DA-AR250)

- The i-ADF allows you to copy 2-sided originals either manually or automatically.

③ Multi-Size Feeding

- Different size originals can be copied full size (1:1) or same size.

④ 2 in 1 Copy

- To make a 1-sided copy (full size or reduction), from two 1-sided originals side-by-side.

2. Components

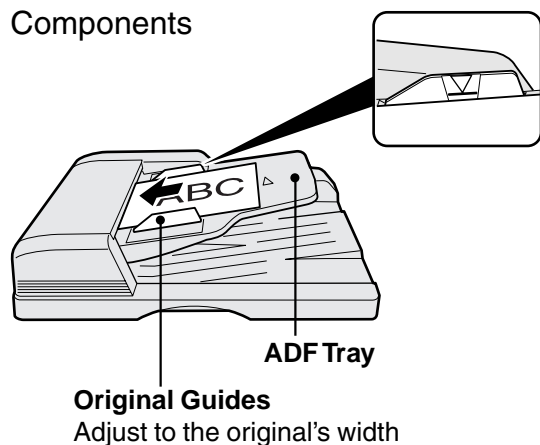

- Set the originals up to the upper limit arrow.

Accessories

Automatic Document Feeder

3. Operation

■ Operation Procedure

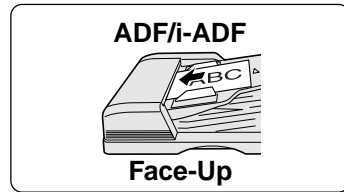

1

Place the Original

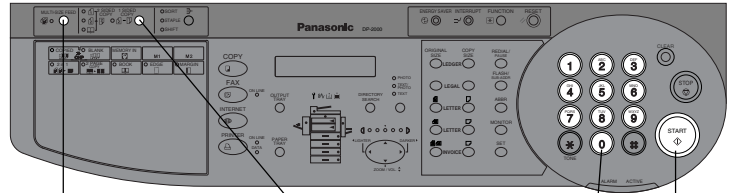
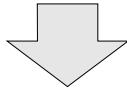

(2)

Select Multi-Size Feeding (If required)

(3)

For Duplex Copy (If required)

4 5

Number of Copies

Press **START**

Inappropriate originals

- Paper with a smooth surface such as glossy and coated papers
- Transparencies
- Originals with a lead edge that is "creased", "folded", "punched" or "glued"
- Paste-ups
- Pressure sensitive or carbon backed papers
- Paper with excessive curl
- Stapled originals
- Freshly printed copies from a laser printer

(2)

Combination of Multi-Size feeding

Originals	Copies		
	Full Size	Reduction	Enlargement
Legal Letter R	Legal Letter R	Letter R/Invoice Letter R/Invoice	Ledger Ledger
Ledger Letter	Ledger Letter	Letter R Legal	—

Finisher/Exit Guide Unit

1. Features

DA-FS200 (Finisher)

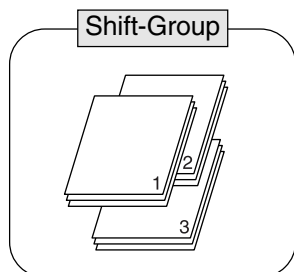

- Shift electronic sort copy

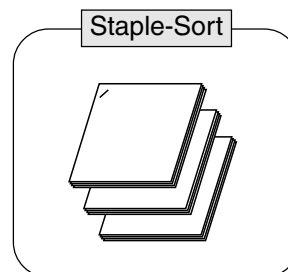
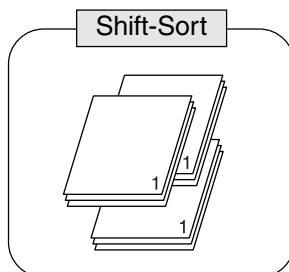

- Staple electronic sort copy

DA-FK200/FK210 (Dual-Path Exit Guide Unit/Paper Transport Unit)

- Feeds paper to finisher

2. Operation

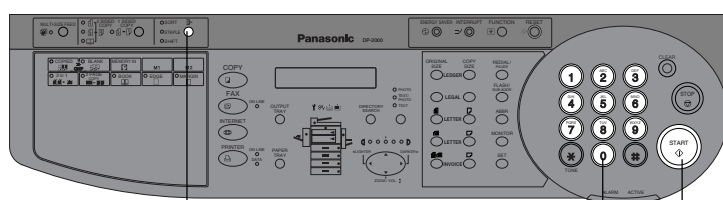
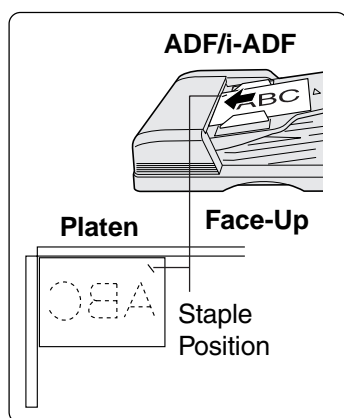

- 1 Place the Original
- 2 Press **Sort/Finish** key (circulation) to select Finisher Mode
- 3 Number of Copies
- 4 Press **START**

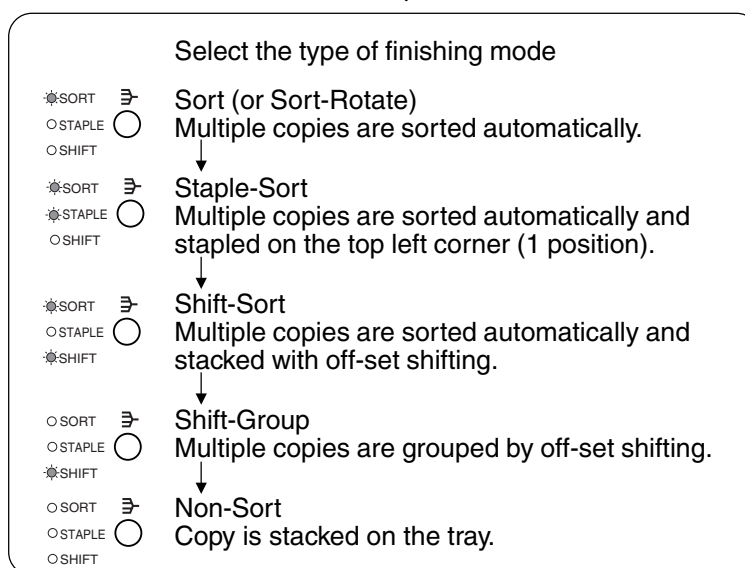
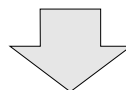

- Sort or Sort-Rotate can be changed by General Functions setting. (see page 29)
- During staple sorting, if more than the allowable maximum number of sheets (30 sheets: Letter, Letter ☐; 20 sheets: Legal; 15 sheets: Ledger) are inserted, or if the staples run out during copying, the copying mode will change to shift sorting.
- Shift-Sort and Staple-Sort are not available on the Invoice ☐ size paper.
- The capacity of the finisher tray is approximately 1000 sheets (Letter, Letter ☐, Invoice ☐), 700 sheets (Legal) or 500 sheets (Ledger).

Accessories

Finisher/Exit Guide Unit

3. Replacing the staple cartridge

ADD STAPLES U11

The message shown on the left appears when the staples run out.

1

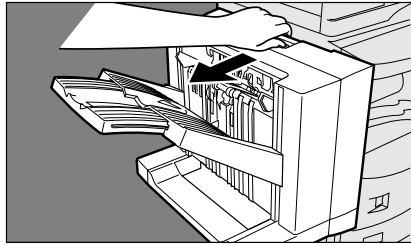

Hold the latch and pull out the finisher.

2

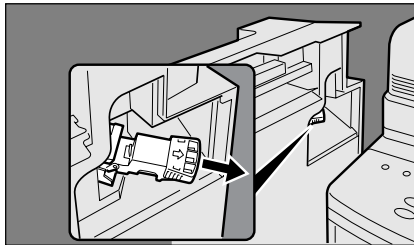

Remove the staple cartridge.

3

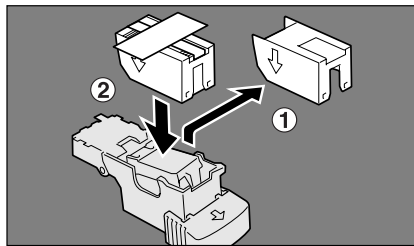

- ① Remove the empty staple case.
- ② Install the new staple case.

4

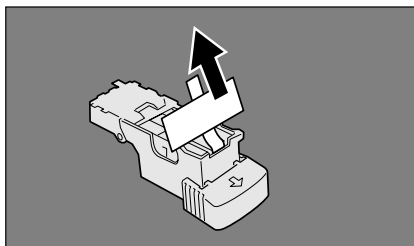

Pull out the tape.

5

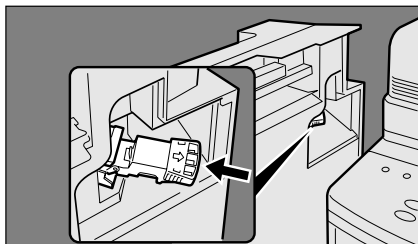

Reinstall the staple cartridge.

6

Return the finisher to the original position.
(Check that the latch is securely fastened.)

Accessories

Finisher/Exit Guide Unit

4. If the unit fails to staple after replacing the staple cartridge, follow the instructions below.

1

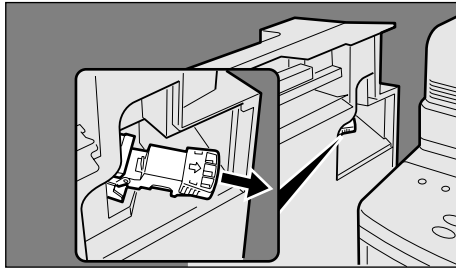

Remove the staple cartridge.

2

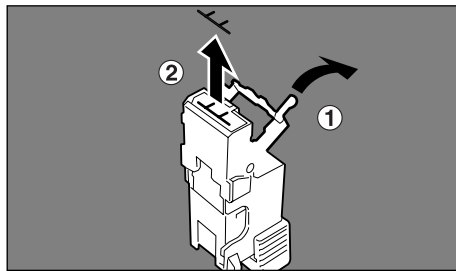

- ① Open the staple cover.
- ② Remove the residual staple.
- ③ Close the staple cover.

3

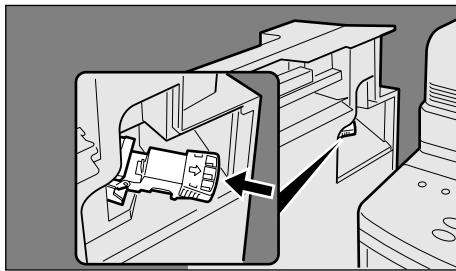

Reinstall the staple cartridge.

Problem Solving

Adding Paper (📄)

■ 550-Sheet Paper Tray

1

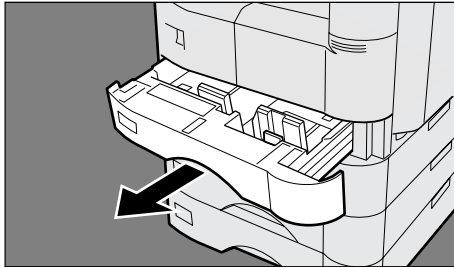

Pull the paper tray out of the copier.

2

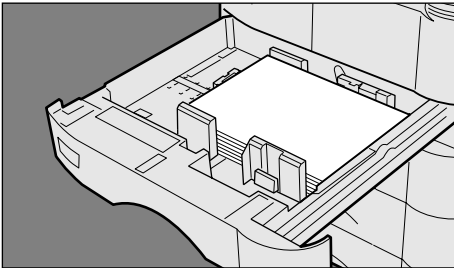

Place the paper with the copying surface facing upward.
Special papers, like glossy paper, mailing labels and transparencies cannot be used in the paper tray. Use the sheet bypass for special paper.

3

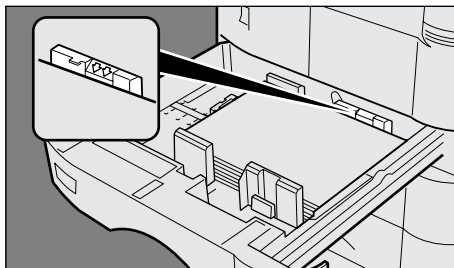

Make sure paper is not loaded above the overfill indicator located in the paper tray.

4

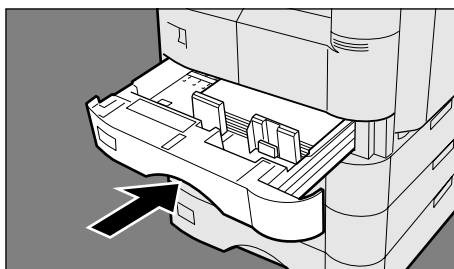

Firmly push the paper tray back into the copier.

ATTENTION

- Do not use paper with folds or wrinkles. Refer to page 34 for details on changing the paper size for the paper tray.
- Unused paper should always be placed into a bag and the opening should be sealed for storage. If the paper is left exposed, problems such as paper curl, paper jams, wrinkles or loss of copied image quality may occur.

Problem Solving

Replacing the Toner Cartridge and Waste Toner Box (🖨️)

1

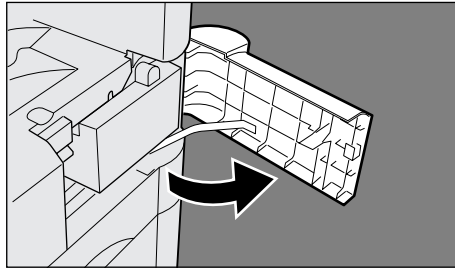

Open the front cover.

2

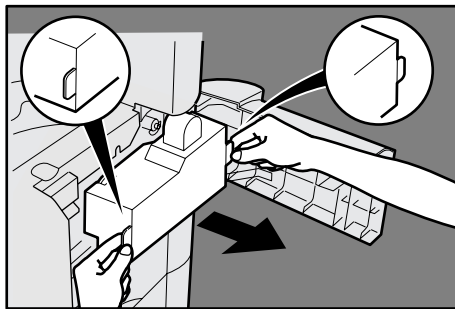

Slowly pull the waste toner box straight out.

3

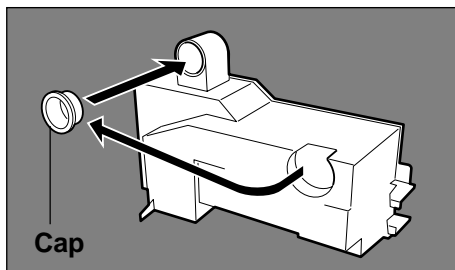

Close the box with the enclosed cap.

4

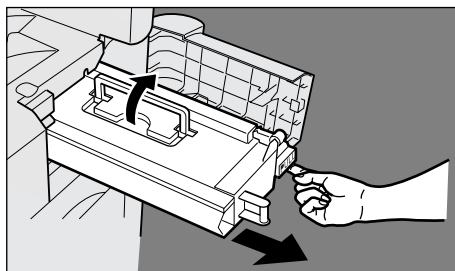

Pull on the Green release latch to remove the Toner Cartridge out of the machine while holding it by the Green handle.

ATTENTION

- For optimum copy quality use the recommended Panasonic toner. Store toner in a cool dark place. Do not unseal toner before use. Use it as fast as possible after unsealing.

5

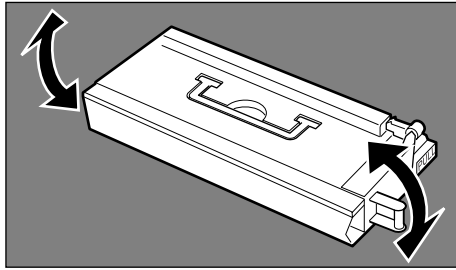

Shake the new toner cartridge well.

6

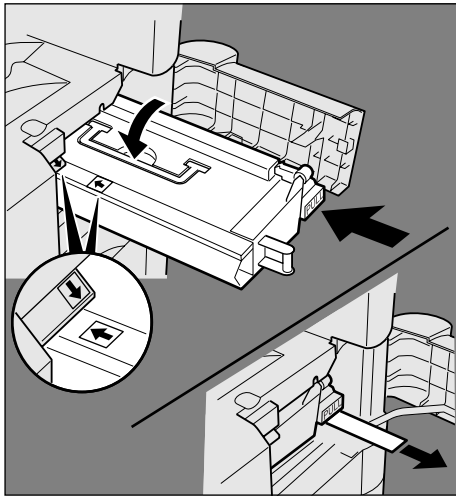

Install the new toner cartridge into the machine, and pull out the protective seal.

Note: Pull on the seal slowly and straight out.

7

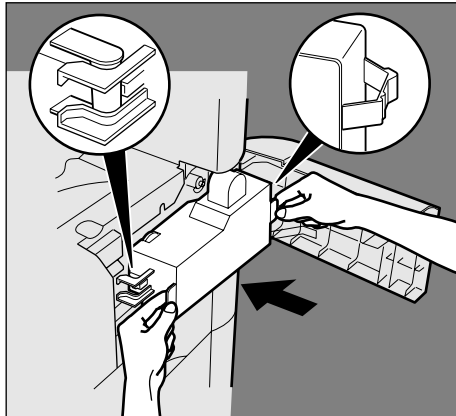

Install a new waste toner box.

8

Close the front cover.

ATTENTION

- Do not reuse the toner from the waste toner box.



Problem Solving

Removing a Misfeed Paper

- **Paper Misfeed Indicators and Locations**
When a paper misfeed occurs, the misfeed indicator and the misfeed location(s) will be displayed on the panel display.

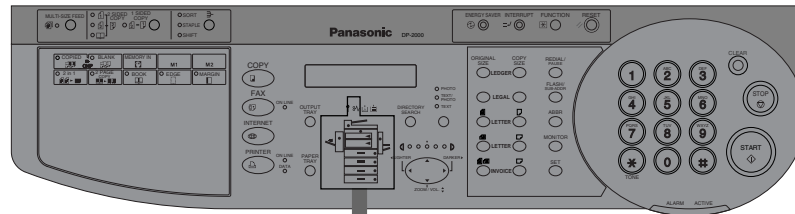

 Misfeed Indicator

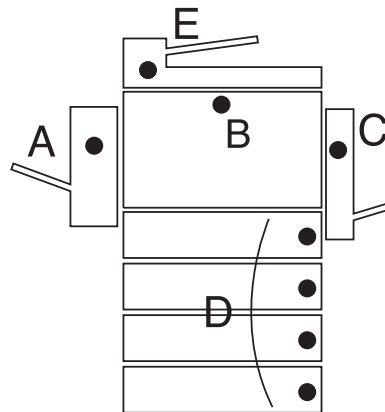

Paper Misfeed Locations

- A: Finisher (see page 49)
- B: Paper transport area (see page 50)
- C: Paper entry area (see page 51)
- D: Paper feed unit (see page 53)
- E: ADF/i-ADF (see page 54)

NOTE

- Make sure that the misfeed indicator goes off after removing the misfeed paper. The misfeed indicator will not go off if the paper is still jammed in the copier. Check again and remove all misfeed paper.

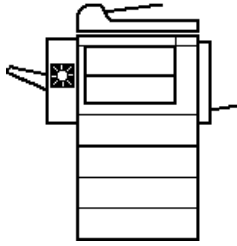

■ Finisher

- Make sure that the misfeed indicator goes off after removing all misfed paper.

1

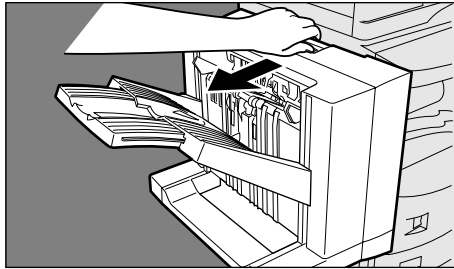

Pull out the finisher.

2

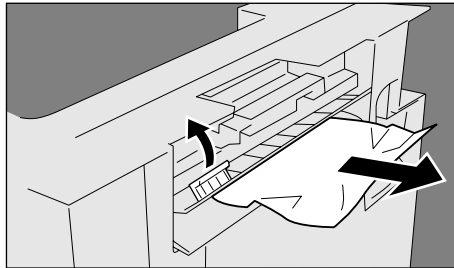

Lift up the lever and clear the paper jam.

3

Return the finisher to the original position.

ATTENTION

- Make sure that the misfeed indicator goes off after removing all misfed paper.

Problem Solving

Removing a Misfed Paper

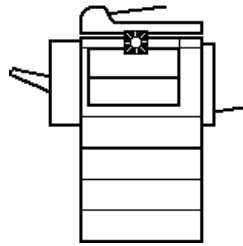

■ Paper Transport Area

- Make sure that the misfeed indicator goes off after removing all misfed paper.

1

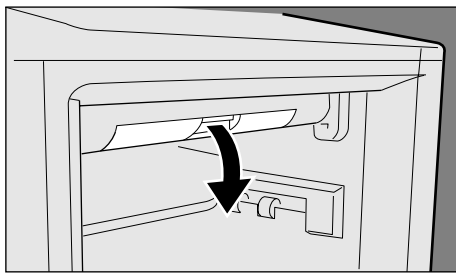

Push the latch to open the cover.

2

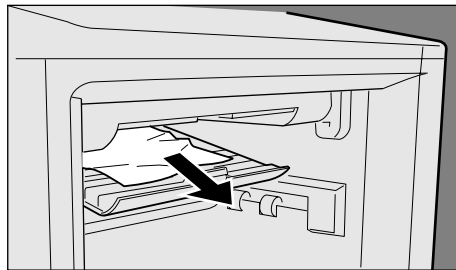

Remove the misfed paper.

3

Close the cover by pushing the latch.
(Check that the latch is securely fastened.)

ATTENTION

- Make sure that the misfeed indicator goes off after removing all misfed paper.

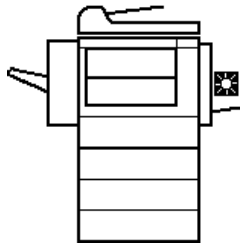

■ Paper Entry Area

- Make sure that the misfeed indicator goes off after removing all misfed paper.

1

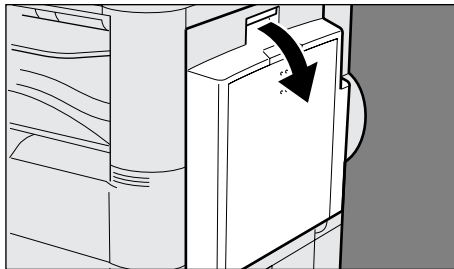

Open the right cover.

2

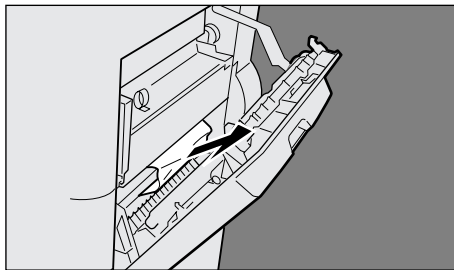

Remove the misfed paper.



3

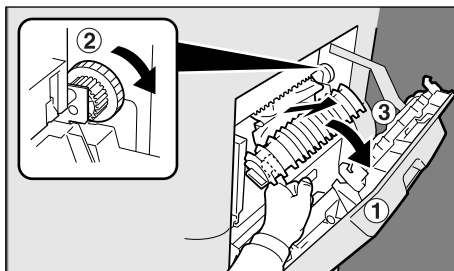

- ① Open the heat roller cover.
- ② If copy paper is fed far into the copier, turn the right paper clearing knob.
- ③ Remove the misfed paper.

Continued on the next page...

ATTENTION

- Make sure that the misfeed indicator goes off after removing all misfed paper.

Problem Solving

4

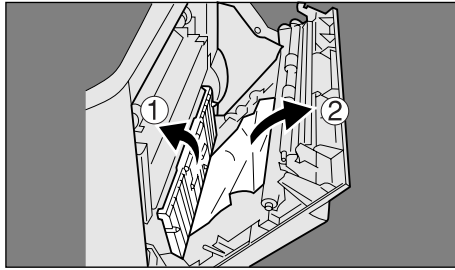

Automatic Duplex Unit (ADU)

- ① Open the paper feed guide.
- ② Remove the misfed paper.

5

Close the right cover.

ATTENTION

- Make sure that the misfeed indicator goes off after removing all misfed paper.

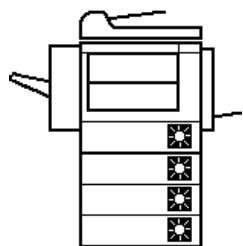

■ System Console

- Make sure that the misfeed indicator goes off after removing all misfed paper.

1

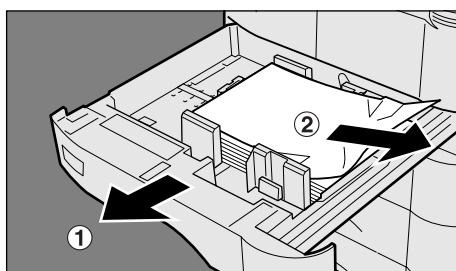

- ① Pull out the paper tray.
- ② Remove the misfed paper.
- ③ Return the paper tray to the original position.

2

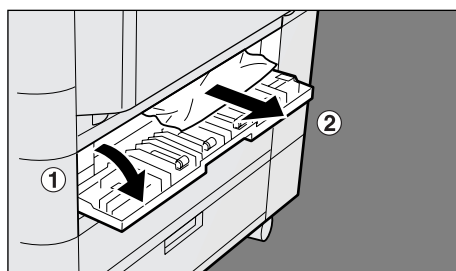

- ① Open the feed cover.
- ② Remove the misfed paper.
- ③ Close the feed cover.

ATTENTION

- Make sure that the misfeed indicator goes off after removing all misfed paper.

Problem Solving

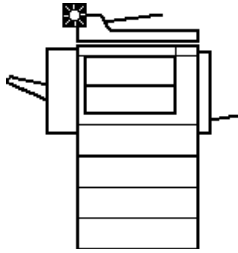

■ ADF/i-ADF

- Make sure that the misfeed indicator goes off after removing all misfed paper.

1

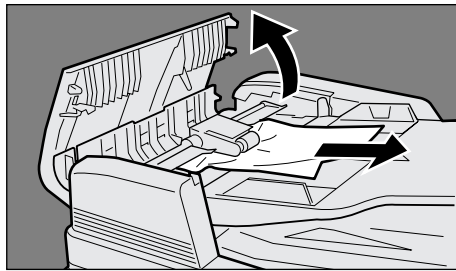

- ① Open the ADF cover.
- ② Remove the misfed paper.
- ③ Close the ADF cover.

2

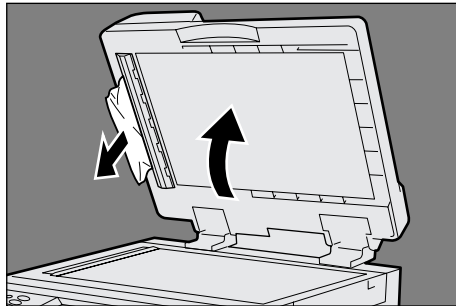

- ① Open the Platen cover.
- ② Remove the misfed paper.
- ③ Close the Platen cover.
- ④ Open and close the ADF cover to reset the error.

ATTENTION

- Push the tab  on the center of the ADF cover to close it.
- Make sure that the misfeed indicator goes off after removing all misfed paper.

3

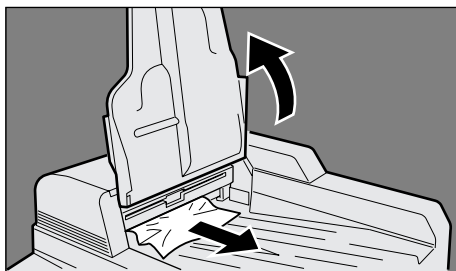

- ① Lift up the ADF Input Tray.
- ② Remove the misfed paper.
- ③ Close the ADF Input Tray.
- ④ Open and close the ADF cover to reset the error.

4

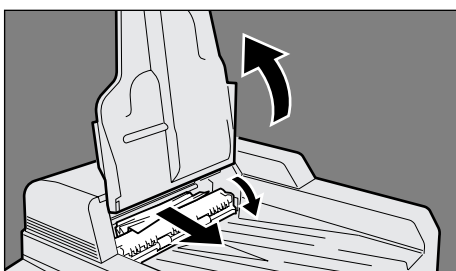

<i>ADF</i>

- ① Lift up the ADF Input Tray.
- ② Open the ADF exit cover.
- ③ Remove the misfed paper.
- ④ Close the ADF exit cover.
- ⑤ Close the ADF Input Tray.

ATTENTION

- Make sure that the misfeed indicator goes off after removing all misfed paper.



Troubleshooting

Before Calling Service

Check

Action

Unit does not operate

Does the display light?



Check if the Power Switch is turned On and if the power plug is inserted into the outlet.

Does the Energy Saver key flash (or light) and displays are turned OFF? (See P.24)



Press Energy Saver key on the control panel.

Does any of the U## codes and messages appear on the display? (U0, U4, U10, U12, U13....etc.,)



Perform actions in accordance with each message.

Does the add staples indicator and message appear on the display?



Add staples (See P.42)
Remove all jammed staples. (See P.44)

Does the add paper indicator and message appear on the display? (紙)



Add paper. (See P.45)

Does the paper misfeed indicator and message appear on the display? (紙/8V/紙)



Remove the misfed paper. (See P.48)

Does E### indicator and message appear on the display?



Turn the copier off, then on. If the error code does not clear, call for service.

Check	Action
Light Copies	
Does the exposure indicator say "lighter"?	➔ Press the Scroll key until the indicator LED is set to Darker. (See P.12)
Does the add toner indicator and message appear on the display? (🖨️)	➔ Replace the Toner Cartridge. (See P.46)
Marked Copies	
Is the copier platen glass or platen cover dirty?	➔ Clean the glass or platen cover. (See below)
Is the original an OHP film or a dark original?	➔ Cover the original with a sheet of white paper before copying or lighten the exposure setting.

■ If the measures outlined above do not solve the problem, call your Service provider.

Copier Care

■ As a rule, clean weekly.

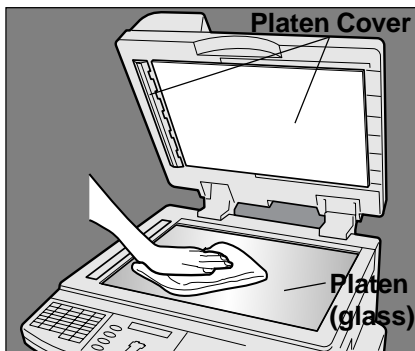

Platen/Platen Cover

- ① Wipe marks off with a cloth and a neutral detergent.
- ② Wipe again with a dry cloth.

Troubleshooting

Replacing the Battery

The copier has an internal battery (Product No.: CR2032) which maintains the date setting in the event of a power outage.

■ Battery Replacement Required Message

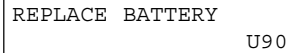

REPLACE BATTERY
U90

■ Battery Replacement Procedure

1

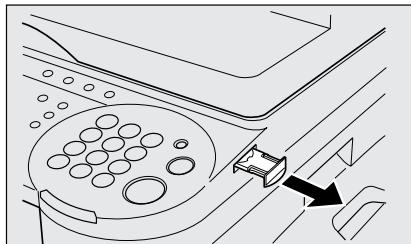

Turn the power off.
Pull out the battery holder.

2

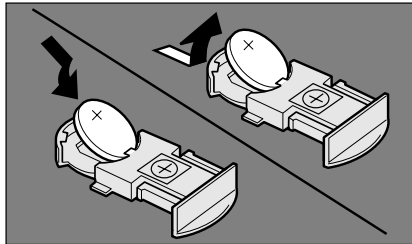

Replace the battery.

3

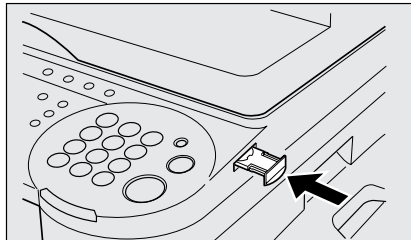

Reinstall the battery holder.

4

Turn the power on.
Set the date and time. (See P.31)

ATTENTION

- The service life of the battery is approximately 1 year when the machine is turned "Off".

CAUTION

denotes hazards that could result in minor injury or damage to the machine.

- THIS PRODUCT CONTAINS A LITHIUM BATTERY. DANGER OF EXPLOSION IF BATTERY IS INCORRECTLY REPLACED. REPLACE ONLY WITH THE SAME OR EQUIVALENT TYPE. DISPOSE OF USED BATTERIES ACCORDING TO THE INSTRUCTIONS OF YOUR LOCAL SOLID WASTE OFFICIALS.

Specifications

■ DP-2000 (Copier)

Type:	Desk Top
Platen Type:	Fixed
Acceptable Originals:	Sheets, Books (max. Ledger)
Copying Method:	Laser Electrophotography
Fixing Method:	Heat Roller Fixing
Imaging Method:	Dry-Type Single component imaging
Resolution:	Max. 600 dpi
Maximum Copy Size:	Ledger - Invoice via paper tray
Void Area:	Max. 0.2" (5 mm)
Warm Up Time:	Approx. 35 seconds (68°F/20°C)
First Copy Time:	4.5 seconds (Letter <input type="checkbox"/> , from 1st tray)
Multi-Copy Speed:	20 Letter size copies per minute
Enlargement Ratios:	Preset: 121%, 129%, 155%, 200% Variable: from 101% to 400% in 1% increments
Reduction Ratios:	Preset: 79%, 77%, 65%, 61%, 50% Variable: from 99% to 25% in 1% increments
Paper Feed:	Paper tray (550 sheets × 1) + Sheet bypass (50 sheets) Feeder unit (option)
Paper Weight:	Paper tray: 16 - 24 lbs. (Bypass: 15 - 34 lbs.)
Quantity Selector:	Max. 999 sheets (output tray capacity is 250 sheets)
Electrical Requirements:	AC 120V, 50/60Hz, 15A
Energy Consumption:	Max. 1.5 kW, 1.8 Wh in Sleep Mode
Dimensions (W)(D)(H):	23.5" (W) × 23.6" (D) × 22.7" (H) (597 × 600 × 576 mm)
Weight:	108 lbs (49 kg)
Operating Environment:	Temperature: 50°F (10°C) - 95°F (35°C) Relative Humidity: 45% - 85% (However, the humidity should be 70% or less at a temperature of 95°F (35°C), and the temperature should be 86°F (30°C) or less at a humidity level of 85%.)

- Specifications are subject to change without notice.

Specifications

■ ADF (DA-AS200), i-ADF (DA-AR250)

	DA-AS200	DA-AR250
Tray Capacity:	Letter, Invoice: 50 sheets (20 lbs) Ledger, Legal: 30 sheets (20 lbs)	
Paper Size:	Invoice/Letter/Legal/Ledger	
Paper Weight:	14 – 28 lbs (50 – 110 g/m ²)	
Electrical Requirements:	Supplied from the copier	
Dimensions (W)(D)(H):	21.7" (W) × 20.5" (D) × 5.3" (H) (552 × 520 × 135 mm)	
Weight:	18.3 lbs (8.3 kg)	20.5 lbs (9.3 kg)

■ 1-Bin Finisher (DA-FS200)

Paper Size:	Invoice/Letter/Legal/Ledger
Paper Weight:	16 – 24 lbs
Stacking Capacity:	Letter: 1000 sheets, Legal: 700 sheets, Ledger: 500 sheets
Staple Sort and Shift Sorting Stacks:	Letter: 30 sheets × 30, Legal: 20 sheets × 30, Ledger: 15 sheets × 30 (Except InvoiceR)
Electrical Requirements:	Supplied from the copier
Dimensions (W)(D)(H):	17.4" (W) × 22.6" (D) × 16.1" (H) (442 × 575 × 408 mm)
Weight:	26.5 lbs (12 kg)

■ 2nd/3rd/4th Paper Feed Module (DA-DS210/DA-DS200)

	DA-DS210	DA-DS200
Paper Size:	Invoice/Letter/Legal/Ledger	
Paper Weight:	16 – 24 lbs	
Electrical Requirements:	Supplied from the copier	
Dimensions (W)(D)(H):	21.7" (W) × 6.1" (D) × 23.0" (H) (550 × 155 × 585 mm)	21.7" (W) × 6.9" (D) × 23.0" (H) (550 × 174 × 585 mm)
Weight:	20.9 lbs (9.5 kg)	18.7 lbs (8.5 kg)

- Specifications are subject to change without notice.

Options and Supplies

- The DP-2000 is a digital photocopier which can produce images with great clarity. Furthermore, its copying functionality can also be greatly enhanced by the addition of the following options and supplies. We hope you find that the wide ranging capabilities will make your office-place more productive and efficient.

Part Name	Part No.	Remarks
Inverting Automatic Document Feeder	DA-AR250	Also referred as i-ADF
Automatic Document Feeder	DA-AS200	Also referred as ADF
Stand for 1-Paper Tray Configuration	DA-DA200	Available for some countries
Stand for 2-Paper Trays Configuration	DA-DA210	Available for some countries
Stand for 3-Paper Trays Configuration	DA-DA220	Available for some countries
Stand for 4-Paper Trays Configuration	DA-DA230	Available for some countries
Plain Cabinet	DA-DE200	For USA only
Plain Stand	DA-D250	For USA only
Base Plate with Casters	DA-D200	For USA only
2nd/4th Paper Feed Module	DA-DS200	
3rd Paper Feed Module	DA-DS210	
Electronic Sorting Board	DA-ES200	Required for: ● Fax Communication Kit ● Parallel Port Interface Kit ● 10/100 Ethernet Interface/Internet Fax Kit ● 1-Bin Finisher
Dual-Path Exit Guide Unit	DA-FK200	
Paper Transport Unit	DA-FK210	
1-Bin Finisher	DA-FS200	
1-Bin Finisher Installation Kit	DA-FS200S	Installation Kit for DA-FS200
Key Counter Cable Kit	DA-KH200	
Automatic Duplex Unit	DA-MD200	
Image Memory (8 MB)	DA-SM08B	For electronic sorting
Image Memory (16 MB)	DA-SM16B	For electronic sorting
Image Memory (128 MB)	DA-SM28B	For electronic sorting
Platen Cover	DA-UC200	
Exit Tray (Inner)	DA-XN200	
Exit Tray (Outer)	DA-XT200	
Toner Cartridge	DQ-TU18B	
Staple Cartridge	DQ-SS200	Staple Cartridge refills (3) for DA-FS200

Options and Supplies

■ For Fax

Part Name	Part No.	Remarks
Fax Communication Kit	DA-FG230	G3 Fax/Tel communication (Requires the Electronic Sorting Board)
2nd G3 Fax Communication Port Kit	DA-FG231	Additional G3 Fax/Tel communication
10/100 Ethernet Interface/ Internet Fax Kit	DA-NE200	Internet Fax communication (Requires the Fax Communication Kit)
Handset Kit	UE-403171 UE-403172	Telephone Handset Kit (For USA and Canada) Telephone Handset Kit (For other countries)
Handset Mounting Kit	UE-408004	Required if 1-Bin Finisher (DA-FS200) is installed
Expansion Flash Memory Card	UE-410047 UE-410048	4 MB Flash Memory Card 8 MB Flash Memory Card
Verification Stamp	DZHT000027	X-Stamp

■ For Printer

Part Name	Part No.	Remarks
Parallel Port Interface Kit	DA-PC200	TWAIN Scanner/GDI Printer Unit (Requires the Electronic Sorting Board installed for Windows GDI printing)
PCL6 Emulation Kit	DA-PC210	Printer Controller for PCL6*
10/100 Ethernet Interface/ Internet Fax Kit	DA-NE200	Network Interface Board (Requires the Electronic Sorting Board)

NOTE

* PCL6 is a Page Description Language of the Hewlett-Packard Company.

U.S.A. Only

WARRANTY

“PANASONIC DOCUMENT IMAGING COMPANY MAKES NO WARRANTIES, GUARANTEES OR REPRESENTATIONS, EXPRESSED OR IMPLIED, TO CUSTOMER WITH RESPECT TO THIS PANASONIC COPIER, INCLUDING BUT NOT LIMITED TO, ANY IMPLIED WARRANTY OF MERCHANTABILITY OR FITNESS FOR A PARTICULAR PURPOSE.

PANASONIC DOCUMENT IMAGING COMPANY ASSUMES NO RISK AND SHALL NOT BE SUBJECT TO LIABILITY FOR ANY DAMAGE, INCLUDING, BUT NOT LIMITED TO DIRECT, INDIRECT, SPECIAL, INCIDENTAL OR CONSEQUENTIAL DAMAGES OR LOSS OF PROFITS SUSTAINED BY THE CUSTOMER IN CONNECTION WITH THE USE OR APPLICATION OF THIS PANASONIC COPIER. SEE YOUR DEALER FOR DETAILS OF DEALER’S WARRANTY.”

IMPORTANT INFORMATION

When requesting information, supplies or service always refer to the model and serial number of your machine. The model and serial number plate (Main Name Plate) is located on the rear side of machine. For your convenience, space is provided below to record information you may need in the future.

Model No.

Serial No.

Date of Purchase

Dealer

Address

Telephone Number

()

Supplies Telephone Number

()

Service Telephone Number

()

Panasonic Document Imaging Company
A Division of Matsushita Electric Corporation of America
Two Panasonic Way
Secaucus, New Jersey 07094

Panasonic Canada Inc.
5770 Ambler Drive, Mississauga,
Ontario L4W 2T3

S1000-2120
DZSD001174-2
December 2000
Printed in Japan