

# AT-8500 Series Layer 2+ Fast Ethernet Switches

---

**AT-8516F/SC**

**AT-8524M**

**AT-8524POE**

**AT-8550GB**

**AT-8550SP**

## Installation Guide

Copyright © 2008 Allied Telesis, Inc.

All rights reserved. No part of this publication may be reproduced without prior written permission from Allied Telesis, Inc.

Allied Telesis is a trademark of Allied Telesis, Inc. Microsoft and Internet Explorer are registered trademarks of Microsoft Corporation.

Netscape Navigator is a registered trademark of Netscape Communications Corporation. All other product names, company names, logos or other designations mentioned herein are trademarks or registered trademarks of their respective owners.

Allied Telesis, Inc. reserves the right to make changes in specifications and other information contained in this document without prior written notice. The information provided herein is subject to change without notice. In no event shall Allied Telesis, Inc. be liable for any incidental, special, indirect, or consequential damages whatsoever, including but not limited to lost profits, arising out of or related to this manual or the information contained herein, even if Allied Telesis, Inc. has been advised of, known, or should have known, the possibility of such damages.

# Electrical Safety and Emissions Standards

---

This product meets the following standards.

## U.S. Federal Communications Commission

### Radiated Energy

Note: This equipment has been tested and found to comply with the limits for a Class A digital device pursuant to Part 15 of FCC Rules. These limits are designed to provide reasonable protection against harmful interference when the equipment is operated in a commercial environment. This equipment generates, uses, and can radiate radio frequency energy and, if not installed and used in accordance with this instruction manual, may cause harmful interference to radio communications. Operation of this equipment in a residential area is likely to cause harmful interference in which case the user will be required to correct the interference at his own expense.

Note: Modifications or changes not expressly approved of by the manufacturer or the FCC, can void your right to operate this equipment.

## Industry Canada

This Class A digital apparatus complies with Canadian ICES-003.

Cet appareil numérique de la classe A est conforme à la norme NMB-003 du Canada.

## European Union Restriction of the Use of Certain Hazardous Substances (RoHS) in Electrical and Electronic Equipment

This Allied Telesis RoHS-compliant product conforms to the European Union Restriction of the Use of Certain Hazardous Substances (RoHS) in Electrical and Electronic Equipment. Allied Telesis ensures RoHS conformance by requiring supplier Declarations of Conformity, monitoring incoming materials, and maintaining manufacturing process controls.

RFI Emissions      FCC Class A, EN55022 Class A, EN61000-3-2, EN61000-3-3, VCCI Class A, C-TICK, CE

**Warning:** In a domestic environment this product may cause radio interference in which case the user may be required to take adequate measures.

Immunity            EN55024

Electrical Safety    EN60950 (TUV), UL 60950 (cUL<sub>US</sub>)



Laser Safety        EN60825

## Translated Safety Statements

---

**Important:** The  indicates that a translation of the safety statement is available in a PDF document titled “Translated Safety Statements” (613-000405) posted on the Allied Telesis website at [www.alliedtelesis.com](http://www.alliedtelesis.com).

# Contents

---

<b>Preface</b> .....	11
Safety Symbols Used in this Document .....	12
Where to Find Web-based Guides .....	13
Contacting Allied Telesis .....	14
Online Support .....	14
Email and Telephone Support .....	14
Returning Products .....	14
For Sales or Corporate Information .....	14
Warranty .....	14
Management Software Updates .....	14
<b>Chapter 1: Overview</b> .....	15
Model Configurations .....	16
Model Descriptions .....	17
AT-8516F/SC .....	17
AT-8524M .....	18
AT-8524POE .....	19
AT-8550GB .....	20
AT-8550SP .....	21
Port Descriptions .....	22
10/100Base-TX Twisted Pair Ports .....	22
10/100/1000Base-T Twisted Pair Ports .....	24
100Base-FX Fiber Optic Ports .....	25
Power Over Ethernet .....	27
Power Budgeting .....	27
Implementation .....	28
GBIC and SFP Slots .....	29
Module Expansion Slots .....	30
LEDs .....	31
Twisted Pair Port LEDs and the LED Mode Select Button .....	31
Fiber Optic Port LEDs .....	34
GBIC and SFP Expansion Slot LEDs .....	35
System LEDs .....	36
RS-232 Terminal Port .....	37
Power Options and Connectors .....	38
RPS Connector .....	38
AC Power Connector .....	39
DC Power Connector .....	39
A Few Basics about Ethernet Switching .....	40
MAC Address Table .....	40
Duplex Mode .....	40
Store and Forward .....	41
Back Pressure and Flow Control .....	41
Network Topologies .....	43
Power Workgroup Topology .....	43
Collapsed Backbone Topology .....	43
Mixed Topology .....	44
<b>Chapter 2: Installation</b> .....	47
Reviewing Safety Precautions .....	48

Selecting a Site for the Switch .....	51
Planning the Installation.....	52
Unpacking the Switch .....	54
Installing the Switch in a Rack.....	55
Installing an Optional Expansion or Stacking Module.....	58
Installing an Optional GBIC.....	60
Installing an Optional SFP Transceiver.....	62
Cabling the Switch .....	64
Cabling Twisted Pair Ports .....	64
Cabling Fiber Optic Ports.....	65
Cabling Expansion Modules .....	67
Powering on an AC Powered Switch .....	68
Wiring and Powering on a DC Powered Unit.....	70
Starting a Local Management Session .....	73
Warranty Registration .....	75
<b>Chapter 3: Troubleshooting</b> .....	<b>77</b>
PWR LED is Off .....	77
Twisted Pair Port Link LED is Off.....	77
Fiber Optic Port Link LED is Off.....	78
PoE Device is Not Receiving Power .....	79
Fault LED is On Continuously.....	79
Cannot Establish a Local Management Session .....	80
<b>Appendix A: Technical Specifications</b> .....	<b>81</b>
Physical Specifications .....	81
Environmental Specifications.....	81
Power Specifications.....	82
Safety and Electromagnetic Emissions Certifications.....	82
RJ-45 Twisted Pair Port Pinouts .....	83
AT-8516F/SC Fiber Optic Port Specifications.....	85
RS-232 Terminal Port Pinouts .....	86
RPS Connector Port Pinouts .....	87
Dual SC Type Connector .....	90

# Figures

---

- Figure 1. AT-8516F/SC Switch Front and Back Panels 9
- Figure 2. AT-8524M Switch Front and Back Panels 10
- Figure 3. AT-8524POE Switch Front and Back Panels 11
- Figure 4. AT-8550GB Switch Front and Back Panels 12
- Figure 5. AT-8550SP Switch Front and Back Panels 13
- Figure 6. GBIC Module 21
- Figure 7. SFP Transceiver 21
- Figure 8. AT-RPS3004 Redundant Power Supply Unit 30
- Figure 9. Power Workgroup Topology 35
- Figure 10. Collapsed Backbone Topology 36
- Figure 11. Mixed Topology 37
- Figure 12. Rack Mount Bracket Positions 47
- Figure 13. Removing the Feet 48
- Figure 14. Removing the Expansion Slot Faceplate 50
- Figure 15. Installing a Module 51
- Figure 16. Securing the Module in the Expansion Slot 51
- Figure 17. Optical Bore and Ferrule of GBIC Module 53
- Figure 18. Installing a GBIC Module 53
- Figure 19. Connecting the Twisted Pair Data Cables 56
- Figure 20. Removing the Dust Covers from the Fiber Optic Ports 57
- Figure 21. Attaching a Fiber Optic Cable 58
- Figure 22. Dual SC Port 58
- Figure 23. Connecting the AC Power Cord 60
- Figure 24. Connecting the RPS DC Cable 61
- Figure 25. Positive, Ground, and Negative Terminals 62
- Figure 26. Stripped Wire 63
- Figure 27. Connecting the Stripped Wire 63
- Figure 28. Connecting an RS-232 Cable to the RS-232 Terminal Port on an AT-8524M Switch 65
- Figure 29. RJ-45 Connector and Port Pin Layout 75
- Figure 30. RPS 16-pin Molex Connector Pin Layout 79
- Figure 31. AT-8524POE RPS Connector Pin Layout 80
- Figure 32. Dual SC Connector 82

Figures

Figure 1. AT-8516F/SC Switch Front and Back Panels .....	17
Figure 2. AT-8524M Switch Front and Back Panels .....	18
Figure 3. AT-8524POE Switch Front and Back Panels .....	19
Figure 4. AT-8550GB Switch Front and Back Panels .....	20
Figure 5. AT-8550SP Switch Front and Back Panels .....	21
Figure 6. GBIC Module .....	29
Figure 7. SFP Transceiver .....	29
Figure 8. AT-RPS3004 Redundant Power Supply Unit .....	38
Figure 9. Power Workgroup Topology .....	43
Figure 10. Collapsed Backbone Topology .....	44
Figure 11. Mixed Topology .....	45
Figure 12. Rack Mount Bracket Positions .....	55
Figure 13. Removing the Feet .....	56
Figure 14. Removing the Expansion Slot Faceplate .....	58
Figure 15. Installing a Module .....	59
Figure 16. Securing the Module in the Expansion Slot .....	59
Figure 17. Optical Bore and Ferrule of GBIC Module .....	61
Figure 18. Installing a GBIC Module .....	61
Figure 19. Connecting the Twisted Pair Data Cables .....	64
Figure 20. Removing the Dust Covers from the Fiber Optic Ports .....	65
Figure 21. Attaching a Fiber Optic Cable .....	66
Figure 22. Dual SC Port .....	66
Figure 23. Connecting the AC Power Cord .....	68
Figure 24. Connecting the RPS DC Cable .....	69
Figure 25. Positive, Ground, and Negative Terminals .....	70
Figure 26. Stripped Wire .....	71
Figure 27. Connecting the Stripped Wire .....	71
Figure 28. Connecting an RS-232 Cable to the RS-232 Terminal Port on an AT-8524M Switch .....	73
Figure 29. RJ-45 Connector and Port Pin Layout .....	83
Figure 30. RPS 16-pin Molex Connector Pin Layout .....	87
Figure 31. AT-8524POE RPS Connector Pin Layout .....	88
Figure 32. Dual SC Connector .....	90



# Tables

---

Table 1. Safety Symbols .....	12
Table 2. Model Configurations .....	16
Table 3. IEEE 802.3af Class vs. Power Levels .....	28
Table 4. LEDs for the 10/100Base-TX Twisted Pair Ports on the AT-8524M, AT-8550GB, and AT-8550SP Switches .....	31
Table 5. LEDs for Ports 49R and 50R on the AT-8550GB and AT-8550SP Switches .....	32
Table 6. LEDs for the 10/100Base-TX Twisted Pair Ports on the AT-8524POE Switch .....	33
Table 7. LEDs for the Fiber Optic Ports on the AT-8516F/SC Switch .....	35
Table 8. LEDs for the Optional GBIC and SFP Ports on an AT-8550GB and AT-8550SP Switches .....	35
Table 9. System LEDs .....	36
Table 10. Twisted Pair Cabling and Distances .....	52
Table 11. Fiber Optic Cabling and Distances .....	53
Table 12. 10/100Base-TX Port MDI/MDI-X Pin Signals .....	83
Table 13. 10/100Base-T Port MDI/MDI-X Pin Signals with PoE .....	83
Table 14. MDI and MDI-X Pin Signals (1000Base-T) .....	84
Table 15. RS-232 Terminal Port Pin Signals .....	86
Table 16. Pin Definitions of the 16-pin RPS Connector .....	87
Table 17. Pin Definitions for the RPS Connector on the AT-8524POE Switch .....	88



# Preface

---

This guide provides the hardware installation instructions for you managed, Layer 2+ AT-8500 Series Fast Ethernet switch. This preface contains the following sections:



- “Safety Symbols Used in this Document” on page 12
- “Where to Find Web-based Guides” on page 13
- “Contacting Allied Telesis” on page 14

## Safety Symbols Used in this Document

---

This document uses the safety symbols defined in Table 1.

Table 1. Safety Symbols

Symbol	Meaning	Description
	Caution	Performing or omitting a specific action may result in equipment damage or loss of data.
	Warning	Performing or omitting a specific action may result in electrical shock.

## Where to Find Web-based Guides

---

The installation and user guides for all Allied Telesis products are available in portable document format (PDF) on our web site at **[www.alliedtelesis.com](http://www.alliedtelesis.com)**. You can view the documents online or download them onto a local workstation or server.

## Contacting Allied Telesis

---

This section provides Allied Telesis contact information for technical support as well as sales or corporate information.

### Online Support

You can request technical support online by accessing the Allied Telesis Knowledge Base from the following web site:

**www.alliedtelesis.com/support**. You can use the Knowledge Base to submit questions to our technical support staff and review answers to previously asked questions.

### Email and Telephone Support

For Technical Support via email or telephone, refer to the Allied Telesis web site: **www.alliedtelesis.com**. Select your country from the list displayed on the website. Then select the appropriate menu tab.

### Returning Products

Products for return or repair must first be assigned a Return Materials Authorization (RMA) number. A product sent to Allied Telesis without a RMA number will be returned to the sender at the sender's expense.

To obtain an RMA number, contact the Allied Telesis Technical Support group at our web site: **www.alliedtelesis.com/support/rma**. Select your country from the list displayed on the website. Then select the appropriate menu tab.

### For Sales or Corporate Information

You can contact Allied Telesis for sales or corporate information at our web site: **www.alliedtelesis.com**. Select your country from the list displayed on the website. Then select the appropriate menu tab.

### Warranty

The AT-8500 Series Layer 2+ Fast Ethernet Switches have a Lifetime Warranty (two years fan and PSU). Go to **www.alliedtelesis.com/warranty** for the specific terms and conditions of the warranty and for warranty registration.

### Management Software Updates

New releases of management software for our managed products are available from either of the following Internet sites:

r Allied Telesis web site: **www.alliedtelesis.com**

r Allied Telesis FTP server: **ftp://ftp.alliedtelesis.com**

If you prefer to download new software from the Allied Telesis FTP server from your workstation's command prompt, you will need FTP client software and you must log in to the server. Enter "anonymous" for the user name and your email address for the password.

## Chapter 1

# Overview

---

The AT-8500 Series switches are managed, Layer 2+ Fast Ethernet switches. These switches are designed to simplify the task of creating or expanding an Ethernet or Fast Ethernet network. This chapter contains the following sections:

- ❑ “Model Configurations” on page 16
- ❑ “Model Descriptions” on page 17
- ❑ “Port Descriptions” on page 22
- ❑ “Power Over Ethernet” on page 27
- ❑ “GBIC and SFP Slots” on page 29
- ❑ “Module Expansion Slots” on page 30
- ❑ “LEDs” on page 31
- ❑ “RS-232 Terminal Port” on page 37
- ❑ “Power Options and Connectors” on page 38
- ❑ “A Few Basics about Ethernet Switching” on page 40
- ❑ “Network Topologies” on page 43

## Model Configurations

---

Table 2 lists the basic model configurations.

Table 2. Model Configurations

Model	Configuration
AT-8516F/SC	16 100Base-FX ports with dual SC connectors plus two expansion slots for optional fiber optic and twisted pair port expansion modules.
AT-8524M	24 10/100Base-TX ports plus two expansion slots for optional fiber optic and twisted pair port expansion modules.
AT-8524POE	24 10/100Base-TX ports with Power Over Ethernet technology, plus two expansion slots for optional fiber optic and twisted pair port expansion modules.
AT-8550GB	48 10/100Base-TX ports, two 10/100/1000Base-T ports, and two expansion slots for optional GBIC modules.
AT-8550SP	48 10/100Base-TX ports, two 10/100/1000Base-T ports, and two expansion slots for optional SFP modules.



## Model Descriptions

**AT-8516F/SC** The AT-8516F/SC switch has 16 100Base-FX fiber optic ports with dual SC connectors. The ports operate at 100 Mbps, half- or full-duplex mode, and have a maximum operating distance of 2 kilometers (1.24 miles) or 412 meters (1,360 feet), depending on the duplex mode, using 50/125 or 62.5/125 micron (core/cladding) multimode fiber optic cable.

Figure 1 illustrates the front panel of the AT-8516F/SC switch.

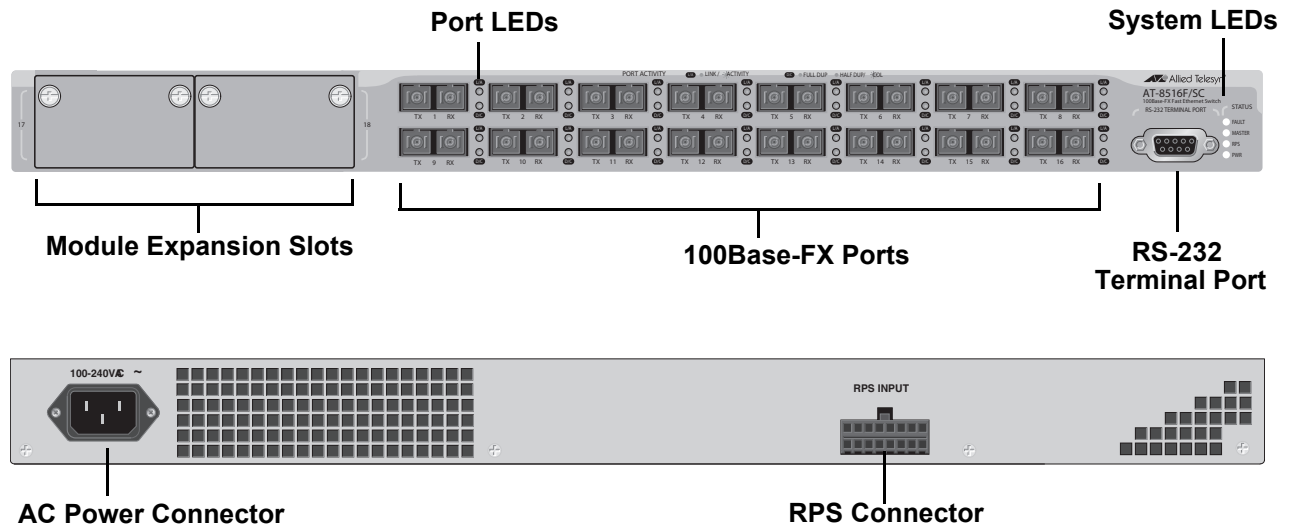

Figure 1. AT-8516F/SC Switch Front and Back Panels

**AT-8524M** The AT-8524M switch has 24 10/100Base-TX twisted pair ports and two module expansion slots. The twisted pair ports feature RJ-45 connectors and have a maximum operating distance of 100 meters (328 feet) using Category 3 or better 100 ohm twisted pair cable for 10Base-T operation and Category 5 or 5E 100 ohm twisted pair cable for 100Base-TX operation.

The expansion slots are compatible with 100Base and 1000Base fiber optic and twisted pair port expansion modules and the AT-STACKM stacking module.

Figure 2 shows the front and back panels of the AT-8524M switch.

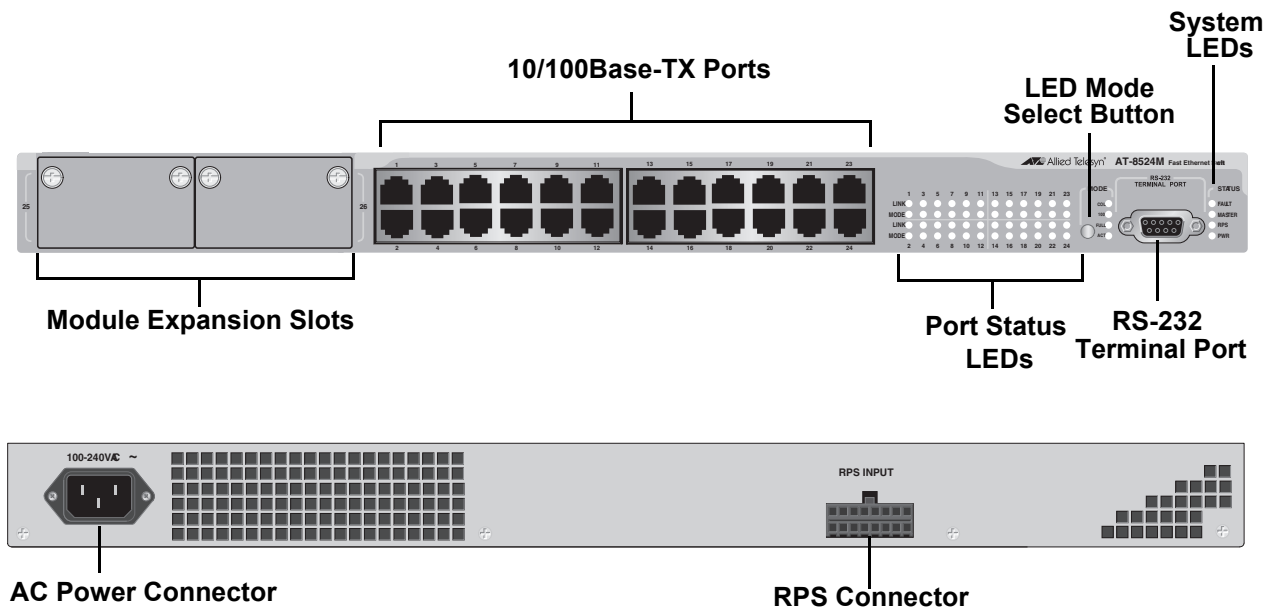

Figure 2. AT-8524M Switch Front and Back Panels

## AT-8524POE

The AT-8524POE switch has 24 10/100Base-TX ports with Power over Ethernet (PoE) capability. (For a description of this feature, refer to “Power Over Ethernet” on page 27.) The ports feature RJ-45 connectors and have a maximum operating distance of 100 meters (328 feet) using twisted pair cable. The ports, when not using PoE, can use Category 3 or better 100 ohm twisted pair cable for 10Base-T operation and Category 5 or 5E 100 ohm twisted pair cable for 100Base-TX operation. For ports using PoE, Category 5 or 5E 100 ohm twisted pair cable is required for both 10 and 100 Mbps operation.

The switch also features two expansion slots that are compatible with 100Base and 1000Base fiber optic and twisted pair port expansion modules and the AT-STACKM stacking module.

Figure 3 shows the front and back panels of the AT-8524POE switch.

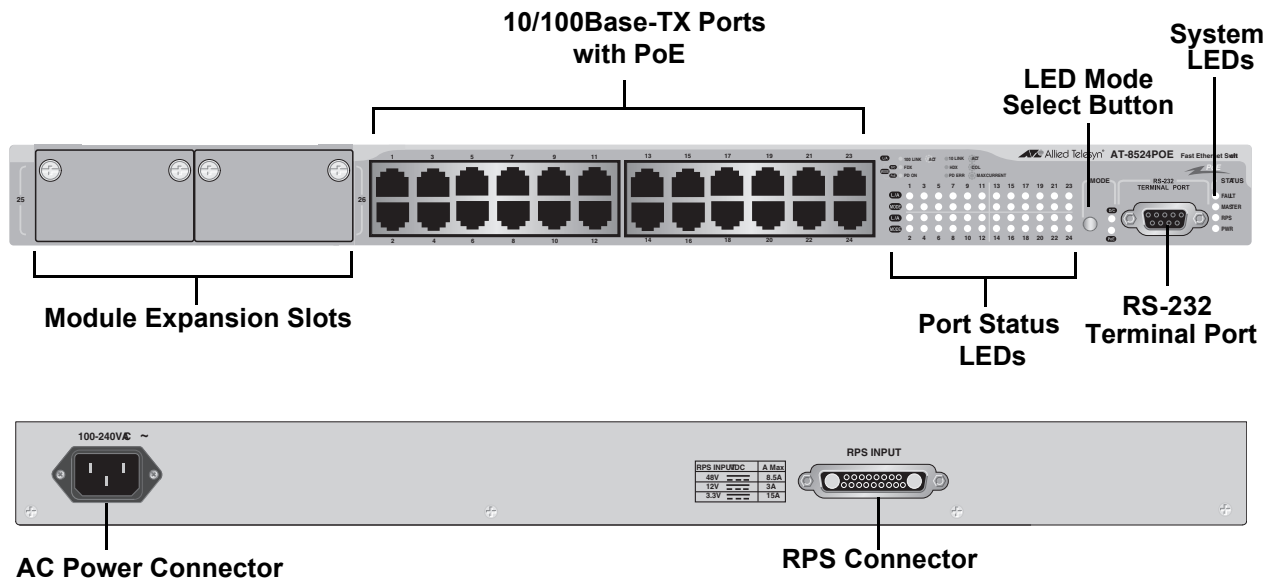

Figure 3. AT-8524POE Switch Front and Back Panels

## AT-8550GB

The AT-8550GB switch has 48 10/100Base-TX twisted pair ports, capable of operating at either 10 or 100 Mbps, with RJ-45 connectors. These ports have a maximum operating distance of 100 meters (328 feet) using Category 3 or better 100 ohm twisted pair cable for 10Base-T operation and Category 5 or 5E 100 ohm twisted pair cable for 100Base-TX operation.

The switch has two 10/100/1000Base-T twisted pair ports, labelled Ports 49R and 50R. They have RJ-45 connectors, require Category 5 or 5E 100 ohm twisted pair cable, and have a maximum operating distance of 100 meters (328 feet).

The switch also has two slots for two Gigabit Interface Converters (GBICs). You can use the GBICs to add 1000Base-X fiber optic ports to the switch to extend the distance of your network. For a list of GBICs supported by the switch, contact your Allied Telesis sales representative or refer to the Allied Telesis web site: [www.alliedtelesis.com](http://www.alliedtelesis.com).

---

### Note

The twisted pair ports 49R and 50R change to a redundant status when GBICs are installed and establish links with their end nodes. A link on a GBIC port always takes precedence over that of the corresponding 10/100/1000Base-T twisted pair port.

---

Figure 4 shows the front and back panels of the AT-8550GB switch.

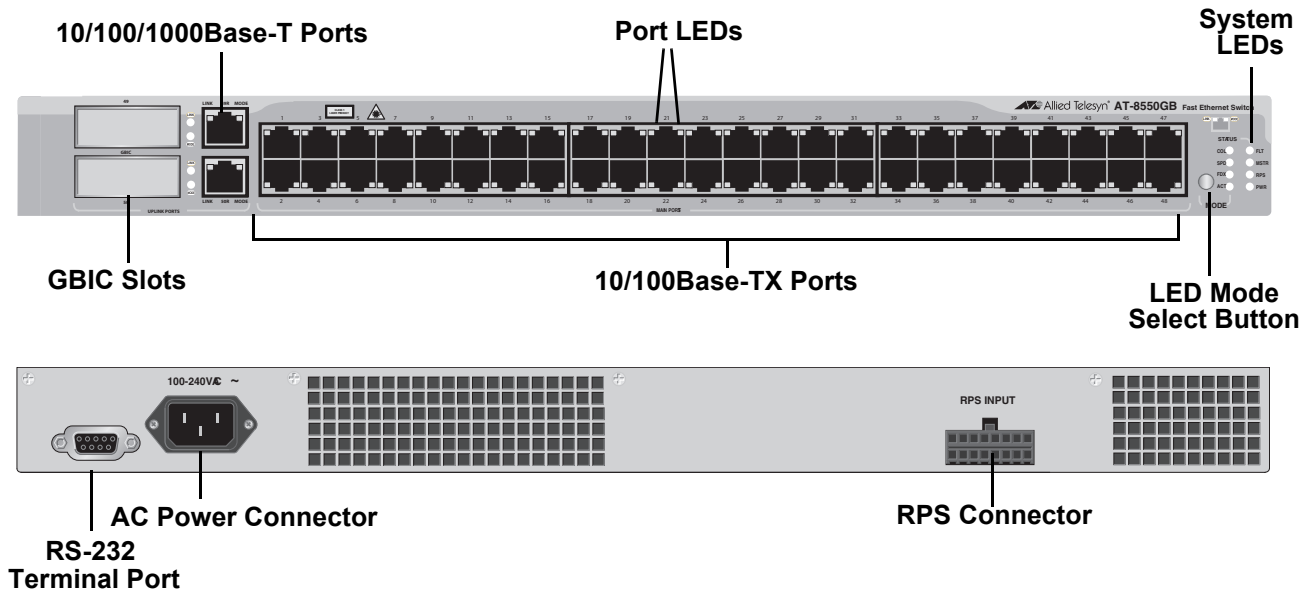

Figure 4. AT-8550GB Switch Front and Back Panels

## AT-8550SP

The AT-8550SP switch has 48 10/100Base-TX twisted pair ports with RJ-45 connectors. The ports have a maximum operating distance of 100 meters (328 feet) using Category 3 or better 100 ohm twisted pair cable for 10Base-T operation and Category 5 or 5E 100 ohm twisted pair cable for 100Base-TX operation.

The switch also features two 10/100/1000Base-T twisted pair ports, labelled Ports 49R and 50R. They have RJ-45 connectors, require Category 5 or 5E 100 ohm twisted pair cable, and have a maximum operating distance of 100 meters (328 feet).

There are also two slots for two Small Form-factor Pluggable (SFP) transceivers. You can use the slots to add 1000Base-X fiber optic ports to the switch. For a list of supported SFP transceivers, contact your Allied Telesis sales representative or refer to the Allied Telesis web site: [www.alliedtelesis.com](http://www.alliedtelesis.com).

---

### Note

The twisted pair ports 49R and 50R change to a redundant status when SFP transceivers are installed and establish links with their end nodes. A link on an SFP port always takes precedence over that of the corresponding 10/100/1000Base-T twisted pair port.

---

Figure 5 shows the front and back panels of the AT-8550GB switch.

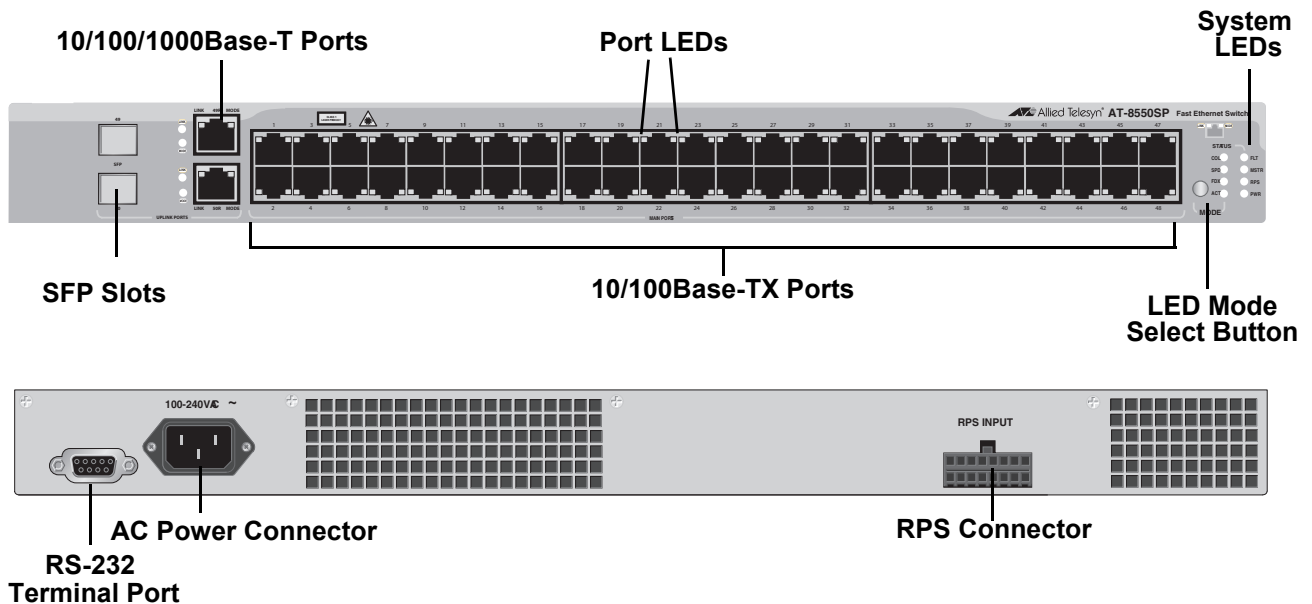

Figure 5. AT-8550SP Switch Front and Back Panels

## Port Descriptions

---

This section provides information on the following port types found on the AT-8500 Series switches:

- “10/100Base-TX Twisted Pair Ports,” next
- “10/100/1000Base-T Twisted Pair Ports” on page 24
- “100Base-FX Fiber Optic Ports” on page 25

### **10/100Base-TX Twisted Pair Ports**

This section applies to the AT-8524M, AT-8524POE, AT-8550GB, and AT-8550SP switches.

#### **Type of Connector**

The 10/100Base-TX twisted pair ports feature 8-pin RJ-45 connectors. Only four of the pins are used when a port is operating at 10 or 100 Mbps

#### **Speed**

The twisted pair ports are 10/100Base-TX compliant and are capable of 10 megabits per second (Mbps) or 100 Mbps speeds. You can set the port speed manually or, because the ports are IEEE 802.3u Auto-Negotiation compliant, you can let the switch set each port’s speed automatically. With Auto-Negotiation, the switch automatically matches the highest possible common speed between each switch port and each end node. For example, if an end node is capable of only 10 Mbps, the switch sets the port connected to the end node to 10 Mbps.

---

#### **Note**

Auto-Negotiation is activated as the default on all twisted pair ports on the switch. To deactivate Auto-Negotiation and set the speeds manually, refer to the *AT-S62 Management Software User’s Guides*.

---

#### **Duplex Mode**

Each twisted pair port on the switch can operate in either half- or full-duplex mode. The twisted pair ports are IEEE 802.3u-compliant and will Auto-Negotiate the duplex mode setting.

If desired, you can disable Auto-Negotiation on one or all of the switch ports so that you can set the duplex mode manually through the switch’s management software.

---

**Note**

In order for a switch port to successfully Auto-Negotiate its duplex mode with an end node, the end node should also be using Auto-Negotiation. Otherwise, a duplex mode mismatch can occur. A switch port using Auto-Negotiation will default to half-duplex if it detects that the end node is not using Auto-Negotiation. This will result in a mismatch if the end node is operating at a fixed duplex mode of full-duplex.

To avoid this problem, when you connect an end node with a fixed duplex mode of full-duplex to a switch port, you should use the AT-S62 management software to disable Auto-Negotiation on the port and set the port speed and duplex mode manually.

---

**Maximum Distance**

Each twisted pair port has a maximum operating distance of 100 meters (328 feet).

**Type of Cabling**

For 10 Mbps operation, Category 3 or better 100 ohm shielded or unshielded twisted pair cabling is required. For 100 Mbps operation, Category 5 or Enhanced Category 5 (5E) 100 ohm shielded or unshielded twisted pair cabling is required.

**Auto-MDI/MDI-X**

The twisted pair ports are auto-MDI/MDI-X. They automatically configure themselves as either MDI or MDI-X, depending on the configuration of the port on the end node. This feature allows you to use either straight-through or crossover twisted pair cables to connect devices to the ports.

---

**Note**

The auto-MDI/MDI-X feature on a port is available only when the port is set to Auto-Negotiation. If you disable Auto-Negotiation and set a port's speed and duplex mode manually, the port defaults to MDI-X. For instructions on configuring a port, refer to the *AT-S62 Management Software User's Guides*.

---

**Port Pinouts**

For the port pinouts for the AT-8524M, AT-8550GB, and AT-8550SP switches, refer to Table 12 on page 83. For the port pinouts for the AT-8524POE switch, refer to Table 13 on page 83.

## **10/100/ 1000Base-T Twisted Pair Ports**

This section applies to Port 49R and Port 50R on the AT-8550GB and AT-8550SP switches.

### **Type of Connector**

The ports have 8-pin RJ-45 connectors. The ports use four pins when operating at 10 or 100 Mbps and all eight pins when operating at 1000 Mbps.

### **Speed**

The ports can operate at 10, 100, or 1000 Mbps. The speed is set automatically through Auto-Negotiation or you can set the speed to 10 or 100 Mbps manually through the management software.

---

#### **Note**

Ports 49R and 50R can operate at 1000 Mbps only when set to Auto-Negotiation. You cannot manually set these ports to 1000 Mbps.

---

### **Duplex Mode**

The ports can operate in either half- or full-duplex mode. The ports are IEEE 802.3u compliant and will Auto-Negotiate the duplex mode. If needed, Auto-Negotiation can be disabled so that you can set the duplex mode manually through the management software.

---

#### **Note**

In order for a 10/100/1000Base-T port to successfully Auto-Negotiate its duplex mode with an end node, the end node should also be using Auto-Negotiation. Otherwise, a duplex mode mismatch can occur. A port, using Auto-Negotiation, will default to half-duplex if it detects that the end node is not using Auto-Negotiation. This will result in a mismatch if the end node is operating at a fixed duplex mode of full-duplex.

To avoid this problem, when you connect an end node with a fixed duplex mode of full-duplex to a 10/100/1000Base-T port, you should use the AT-S62 management software to disable Auto-Negotiation on the port and set the port speed and duplex mode manually.

---

### **Maximum Distance**

The ports have a maximum operating distance of 100 meters (328 feet).

Type of Cable



For 10 Mbps, the port requires Category 3 or better 100 ohm shielded or unshielded twisted pair cabling. For 100 or 1000 Mbps operation, the ports require Category 5 or Enhanced Category 5 (5E) 100 ohm shielded or unshielded twisted pair cabling.

### **Auto-MDI/MDI-X**

The ports are auto-MDI/MDI-X. They automatically configure themselves as either MDI or MDI-X. This feature allows you to use a straight-through twisted pair cable to connect any type of device to a port.

---

#### **Note**

The auto-MDI/MDI-X feature on a 10/100/1000Base-T port is functional only when the port is set to Auto-Negotiation. If you disable Auto-Negotiation and set the port's speed and duplex mode manually, the port defaults to MDI-X. For instructions on configuring a port, refer to the *AT-S62 Management Software User's Guides*.

---

### **Port Pinouts**

For the pinouts of these ports when operating at 10 or 100 Mbps, refer to Table 12 on page 83. For port pinouts when the ports are operating at 1000 Mbps, refer to Table 14 on page 84.

## **100Base-FX Fiber Optic Ports**

This section applies to the AT-8516F/SC switch.

### **Type of Connector**

The fiber optic ports on the AT-8516F/SC switch have dual SC connectors.

### **Speed**

The fiber optic ports have a fixed operating speed of 100 megabits per second (Mbps). The speed cannot be changed.

### **Duplex Mode**

The fiber optic ports can operate in either half- or full-duplex mode. You can set the duplex mode manually or allow the switch to set it automatically through Auto-Negotiation.

### **Maximum Distance**

Each fiber optic port has a maximum operating distance of two kilometers (1.25 miles) when operating in full-duplex mode and 412 meters (1,360 feet) when operating in half-duplex mode.

## **Type of Cable**

The fiber optic ports can use either 50/125 or 62.5/125 micron multimode fiber optic cable.

---

### **Note**

Do not use single-mode fiber optic cable with these ports.

---

## Power Over Ethernet

---

The following discussion applies only to the AT-8524POE switch.

The twisted pair ports on the AT-8524POE switch feature Power over Ethernet (PoE). PoE is a mechanism for supplying power to network devices over the same twisted pair cables used to carry network traffic. This feature can simplify network installation and maintenance by allowing you to use the switch as a central power source for other network devices.

A device that receives its power over an Ethernet cable is called a *powered device*. Examples of such devices can be wireless access points, IP telephones, web cams, and even other Ethernet switches. A powered device connected to a port on the switch will receive both network traffic and power over the same twisted pair cable.

There are several advantages that the PoE feature of the AT-8524POE switch adds to the installation and maintenance of your network. First, because the switch acts as the central power source for your powered devices, adding an uninterruptible power source (UPS) to the switch increases the protection not just to the switch itself from possible power source problems but also to all of the powered devices connected to it. This can increase the reliability of your network by minimizing the impact to network operations from a power failure.

PoE can also simplify the installation of your network. A frequent issue in selecting a location for a network device is whether there is a power source nearby. This often limits equipment placement or requires the added cost and time of having additional electrical sources installed. With PoE, you can install PoE-compatible network equipment wherever they are needed without having to worry about whether they are near a power source.

The switch automatically determines whether or not a device connected to a port is a powered device. A powered device has a signature resistor or signature capacitor that the switch can detect over the Ethernet cabling. If the resistor or capacitor is present, the switch assumes that the device is a powered device.

### Power Budgeting

The AT-8524POE Layer 2+ Fast Ethernet Switch provides a maximum of 15.4 W of power per port on all 24 ports for a total power consumption of 370 W, while at the same time furnishing standard 10/100 Mbps Ethernet functionality.

The AT-8524POE smart power management functionality supports any combination of Ethernet ports (1-24) that supply power for IEEE 802.3af Class 0, 1, 2, or 3 powered devices up to a maximum of 370 watts, as

described in Table 3. .

Table 3. IEEE 802.3af Class vs. Power Levels

Class	Usage	Minimum Power Levels Output at the PSE	Maximum Power Levels Output at the PD
0	Default	15.4W	0.44W to 12.95W
1	Optional	4.0W	0.44W to 3.84W
2	Optional	7.0W	3.84W to 6.49W
3	Optional	15.4W	6.49W to 12.95W

A port connected to a network node that is not a powered device (that is, a device that receives its power from another power source) functions as a regular Ethernet port, without PoE. The PoE feature remains enabled on the port but no power is delivered to the device.

## Implementation

A standard Ethernet twisted pair cable contains four pairs of strands for a total of eight strands. 10/100 Mbps network traffic requires only four strands (1, 2, 3, and 6), leaving four strands in the cable unused (4, 5, 7, and 8).

The PoE standard, IEEE 802.3af, describes two alternative ways for delivering power to a powered device (PD) over twisted pair cabling. Alternative A uses the same strands that carry the network traffic. Alternative B uses the spare strands. The PoE implementation on the AT-8524POE Layer 2+ Fast Ethernet Switch is Alternative A, where power is transmitted over strands 1, 2, 3, and 6.

PD's that comply with the IEEE 802.3af standard typically support both power delivery methods. So long as a PD is compliant with the standard, it should be able to receive its power from the switch while using either a straight or cross-over cable. The PoE feature on the AT-8524POE Layer 2+ Fast Ethernet Switch should also work with most legacy PD's as long as the device can be powered on pins 1, 2, 3, and 6. A legacy device is a node that was manufactured before the IEEE 802.3af standard was completed and, consequently, may not adhere to the standard. If this is the case, a straight (MDI) cable may be needed to insure that the DC polarity is correct.

## GBIC and SFP Slots

---

The AT-8550GB switch has two GBIC slots, and AT-8550SP switch has two SFP slots. The slots are labelled Port 49 and Port 50. Each slot can accommodate one optional fiber optic Gigabit Interface Converter (GBIC) or Small Form-factor Pluggable (SFP) transceiver.

These modules are a fast and easy way for you to add an 1000 Mbps fiber optic port to your Fast Ethernet switch. You can use the modules to extend the distance of your network, build a high-speed backbone network between switches, or connect additional end nodes to the network, such as high-speed servers.

Figure 6 shows an example of a fiber optic GBIC, and Figure 7 shows an SFP transceiver.

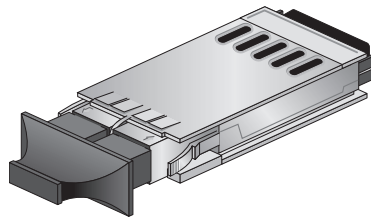

Figure 6. GBIC Module

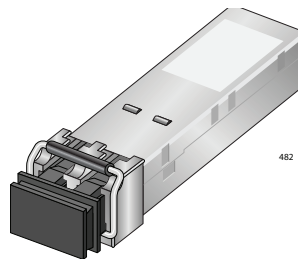

Figure 7. SFP Transceiver

When you install a GBIC or SFP in Port 49 or Port 50 and the module establishes a link with its end node, the corresponding twisted pair port, Port 49R or 50R, changes to a redundant status. A link on a GBIC or SFP port always takes precedence over that of the corresponding 10/100/1000Base-T twisted pair port.

---

For a list of the GBIC and SFP modules supported by the AT-8550GB and AT-8550SP switches, contact your Allied Telesis sales representative or refer to our web site at: [www.alliedtelesis.com](http://www.alliedtelesis.com).

---

## Module Expansion Slots

---

The AT-8516F/SC, AT-8524M, and AT-8524POE switches have two expansion slots. Each slot can accommodate an expansion module. You can use the slots to add 100Base and 1000Base fiber optic and twisted pair ports to the switch.

---

**Note**

For a list of the Allied Telesis expansion modules supported by the switches, contact your Allied Telesis sales representative or refer to our web site at: [www.alliedtelesis.com](http://www.alliedtelesis.com).

---

## LEDs

---

This section provides information on the LEDs found on the AT-8500 Series switches:

- ❑ “Twisted Pair Port LEDs and the LED Mode Select Button,” next
- ❑ “Fiber Optic Port LEDs” on page 34
- ❑ “GBIC and SFP Expansion Slot LEDs” on page 35
- ❑ “System LEDs” on page 36

### Twisted Pair Port LEDs and the LED Mode Select Button

This section applies to the AT-8524M, AT-8524POE, AT-8550GB, and AT-8550SP switches.

The port LEDs on the front panel display port status information. Each port has two LEDs. One of the LEDs displays the status of the link between a port and its end node. The second LED, labeled MODE, displays a variety of status information, depending on the switch model. You use the Mode Select button on the front panel to toggle the Mode LEDs to display different status information. The LEDs next to the Mode Select button indicate the status being displayed by the port Mode LEDs.

---

#### Note

Toggleing the Mode Selection button does not affect the normal operations of the switch.

---

Table 4 describes the LEDs for the 10/100Base-TX twisted pair ports on the AT-8524M, AT-8550GB, and AT-8550SP switches.

Table 4. LEDs for the 10/100Base-TX Twisted Pair Ports on the AT-8524M, AT-8550GB, and AT-8550SP Switches

LED	State	Description
LINK	OFF	Indicates that there is no link between the port and the end node.
	Green	Indicates a valid link has been established between the port and the end node.
Mode - COL	OFF	Indicates that no data collisions are occurring on the port.
	Flashing Green	Indicates that data collisions are occurring on the port.

Table 4. LEDs for the 10/100Base-TX Twisted Pair Ports on the AT-8524M, AT-8550GB, and AT-8550SP Switches (Continued)

LED	State	Description
Mode - 100 (AT-8524M)	OFF	Indicates that the port is operating at 10 Mbps.
	Green	Indicates that the port is operating at 100 Mbps.
Mode - SPD (AT-8550GB and AT-8550SP)	OFF	Indicates that the port is operating at 10 Mbps.
	Green	Indicates that the port is operating at 100 Mbps.
Mode - FULL (AT-8524M)	OFF	Indicates that the port is operating in half-duplex mode.
	Green	Indicates that the port is operating in full-duplex mode.
MODE - FDX AT-8550GB and AT-8550SP)	OFF	Indicates that the port is operating in half-duplex mode.
	Green	Indicates that the port is operating in full-duplex mode.
Mode - ACT	OFF	Indicates that there is no activity on the port.
	Flashing Green	Indicates that the port is transmitting and/or receiving data packets.

Table 5 describes the LEDs for the 10/100/1000Base-TX twisted pair ports, Ports 49R and 50R, on the AT-8550GB and AT-8550SP switches.

Table 5. LEDs for Ports 49R and 50R on the AT-8550GB and AT-8550SP Switches

LED	State	Description
LINK	OFF	Indicates that there is no link between the port and the end node.
	Green	Indicates a valid link has been established between the port and the end node.
Mode - COL	OFF	Indicates that no data collisions are occurring on the port.
	Flashing Green	Indicates that data collisions are occurring on the port.



Table 5. LEDs for Ports 49R and 50R on the AT-8550GB and AT-8550SP Switches (Continued)

LED	State	Description
Mode - SPD	OFF	Indicates that the port is operating at 10 or 100 Mbps.
	Green	Indicates that the port is operating at 1000 Mbps.
Mode - FDX	OFF	Indicates that the port is operating in half-duplex mode.
	Green	Indicates that the port is operating in full-duplex mode.
Mode - ACT	OFF	Indicates that there is no activity on the port.
	Flashing Green	Indicates that the port is transmitting and/or receiving data packets.

Table 6 describes the LEDs for the 10/100Base-TX twisted pair ports on the AT-8524POE switch.

Table 6. LEDs for the 10/100Base-TX Twisted Pair Ports on the AT-8524POE Switch

LED	State	Description
L/A	OFF	Indicates that the port has not established a link with its end node.
	Steady Green	Indicates the port has established a valid 100 Mbps link with its end node.
	Flashing Green	Indicates the port is receiving or transmitting packets at 100 Mbps.
	Steady Amber	Indicates the port has established a valid 10 Mbps link with its end node.
	Flashing Amber	Indicates the port is receiving or transmitting packets at 10 Mbps.

Table 6. LEDs for the 10/100Base-TX Twisted Pair Ports on the AT-8524POE Switch (Continued)

LED	State	Description
Mode - DC	OFF	Indicates that the port has not established a valid link with its end node.
	Steady Green	Indicates that the port is operating in full duplex mode.
	Steady Amber	Indicates that the port is operating in half duplex mode.
	Flashing Amber	Indicates that the port is operating in half duplex mode and that data collisions are occurring on the port.
Mode - POE	OFF	Indicates that the device connected to the port is not a powered device and does not require PoE.
	Green	Indicates that the end node is a powered device and that the port is providing power to it.
	Steady Amber	Indicates that the port experienced a problem providing PoE to the end node. For further information, refer to Chapter 3, "Troubleshooting" on page 77.
	Flashing Amber	Indicates that the port is connected to a powered device but that providing power to it would exceed the maximum PoE power budget of the switch. For further information, refer to Chapter 3, "Troubleshooting" on page 77.

**Fiber Optic Port LEDs**

This section applies to the AT-8516F/SC switch. The fiber optic ports on an AT-8516F/SC switch have two LEDs, labeled L/A and D/C. The LEDs

are defined in Table 7.

Table 7. LEDs for the Fiber Optic Ports on the AT-8516F/SC Switch

LED	State	Description
L/A	OFF	Indicates no link has been established between the port and the end node.
	Green	Indicates a valid link exists between the port and the end node.
	Flashing Green	Indicates that the port is transmitting and/or receiving data packets.
D/C	Green	Indicates that the port is operating in full-duplex mode.
	Amber	Indicates that the port is operating in half-duplex mode.
	Flashing Amber	Indicates that data collisions are occurring on the port.

---

**Note**

The AT-8516F/SC switch does not have an LED Mode Select button.

---

### GBIC and SFP Expansion Slot LEDs

The GBIC and SFP slots on the AT-8550GB and AT-8550SP switches, respectively, have two LEDs. The LEDs display the operating status of the fiber optic port. Use the Mode Select button on the switch to toggle the status information displayed by the MODE LED. The LEDs are defined in Table 8.

Table 8. LEDs for the Optional GBIC and SFP Ports on an AT-8550GB and AT-8550SP Switches

LED	State	Description
LINK	OFF	Indicates that there is no link between the port and the end node.
	Solid Green	Indicates a valid link has been established between the port and the end node.
Mode - COL	OFF	Indicates that no data collisions are occurring on the port.
	Flashing Green	Indicates that data collisions are occurring on the port.

Table 8. LEDs for the Optional GBIC and SFP Ports on an AT-8550GB and AT-8550SP Switches

LED	State	Description
Mode - SPD	Solid Green	Indicates that the port is operating at 1000 Mbps.
Mode - FDX	OFF	Indicates that the port is operating in half-duplex mode.
	Solid Green	Indicates that the port is operating in full-duplex mode.
Mode - ACT	OFF	Indicates that there is no activity on the port.
	Flashing Green	Indicates that the port is transmitting and/or receiving data packets.

## System LEDs

The system LEDs on the front panel display general status information, as described in Table 9.

Table 9. System LEDs

LED	State	Description
FAULT or FLT	OFF	Indicates normal operation.
	Red	Indicates that the management software is saving a change to its configuration. The LED goes off once the configuration has been saved.  If the FAULT LED remains on, the switch or management software may have experienced a malfunction. Refer to Chapter 3, "Troubleshooting" on page 77 for instructions on how to troubleshoot a problem.
MASTE R or MSTR	Green	Indicates that the switch is functioning as the master switch of an enhanced stack.
	OFF	Indicates that the switch is a slave switch or is not a member of a stack.
RPS	Green	Indicates that an optional redundant power supply is connected to the switch.
	OFF	Indicates that there is no optional redundant power supply connected to the switch.
PWR	Green	Indicates that the switch is receiving power.

## RS-232 Terminal Port

---

You can use the RS-232 terminal port to establish a local (out-of-band) management session with the switch and to configure the switch's operating parameters. You establish a local management session with the switch by connecting either a terminal or a personal computer with a terminal emulation program to the port.

---

**Note**

You are not required to manage an AT-8500 Series switch. If the default switch settings are adequate for your network, you can use the unit as an unmanaged switch. For the default settings, refer to the *AT-S62 Management Software User's Guides*.

---

The RS-232 terminal port has a DB-9 female connector and uses a straight-through RS-232 cable (included with the switch). The default settings for the RS-232 terminal port are:

- Baud rate: 9600 bps
- Data bits: 8
- Parity: None
- Stop bits: 1
- Flow control: None

---

**Note**

These settings are for a DEC VT100 or ANSI terminal, or an equivalent terminal emulation program.

---

## Power Options and Connectors

---

This section provides information about the power options and features on the AT-8500 Series switches:

- “RPS Connector,” next
- “AC Power Connector” on page 39
- “DC Power Connector” on page 39

### RPS Connector

The RPS connector on the back panel of the switch connects to an optional AT-RPS3004 or AT-RPS3104 redundant power supply unit. Figure 8 illustrates an AT-RPS3004 unit. A redundant power supply unit can provide power to the switch in the event the switch’s internal power supply should fail.

---

#### Note

The AT-RPS3004 unit is used with the AT-8516F/SC, AT-8524M, AT-8550GB, and AT-8550SP switches. The AT-RPS3104 unit is used with the AT-8524POE switch. Do not use the AT-RPS3004 unit with the AT-8524POE switch.

---

A redundant external power supply comes with one pre-installed power module and has three empty slots for additional power modules. Each power module can support one switch, making the unit capable of supporting up to four switches simultaneously.

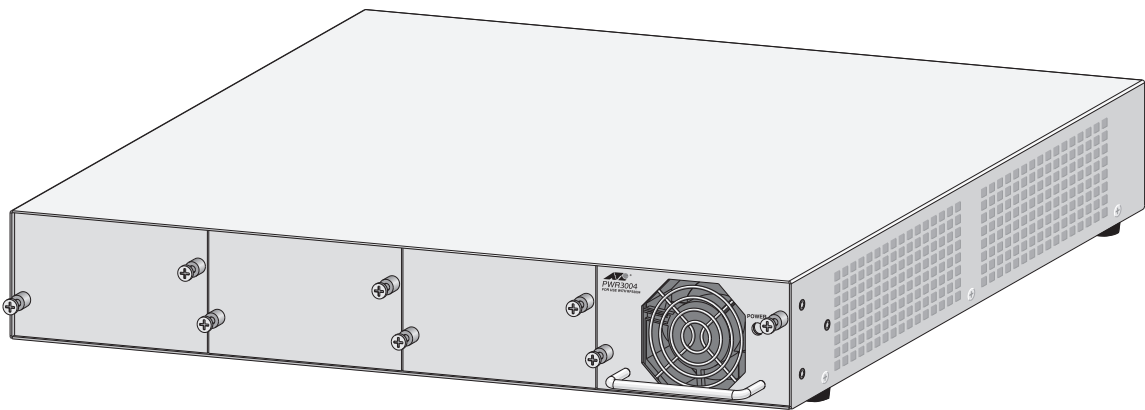

Figure 8. AT-RPS3004 Redundant Power Supply Unit

---

#### Note

DC models of the AT-8500 Series switches do not feature an RPS connector.

---

**AC Power  
Connector**

The switch has a single AC power supply socket on the back panel, which has autoswitch AC inputs. To power the switch on or off, you connect or disconnect the power cord.

Refer to Appendix A, “Technical Specifications” on page 81 for the input voltage range.

**DC Power  
Connector**

Some models of the AT-8500 Series switch are offered with a DC terminal block on the back panel instead of an AC socket, for those network installations that require DC equipment. Refer to Appendix A, “Technical Specifications” on page 81, for the input voltage range and “Wiring and Powering on an DC Powered Unit” on page 70, for instructions on how to wire a DC powered unit.

## A Few Basics about Ethernet Switching

---

An Ethernet switch interconnects network devices, such as workstations, printers, routers, and other Ethernet switches, so that they can communicate with each other by sending and receiving Ethernet frames.

### **MAC Address Table**

Every hardware device in your network has a MAC address and each MAC address is unique. The address is assigned to a device by the device's manufacturer. For example, the network interface cards that you install in your computers have a unique MAC address assigned to them by the adapter manufacturers.

An AT-8500 Series Fast Ethernet Switch has a MAC address table capable of storing up to 8,000 MAC addresses. The switch uses the table to store the MAC addresses of the network end nodes connected to the ports, along with the port number on which each address was learned.

A switch learns the MAC addresses of the end nodes by examining the source address of each packet received on a port. It adds the address and port on which the packet was received to the MAC table if the address had not already been entered in the table. The result is a table that contains all the MAC addresses of the devices that are connected to the switch's ports, and the port number where each address was learned.

When the switch receives a packet, it also examines the destination address and, by referring to its MAC address table, determines the port on which the destination end node is connected. It then forwards the packet to the appropriate port and on to the end node. This increases network bandwidth by limiting each packet to the appropriate port when the intended end node is located, freeing the other switch ports for receiving and transmitting data.

If the switch receives a packet with a destination address that is not in the MAC address table, it floods the packet to all the ports on the switch. If the ports have been grouped into virtual LANs, the switch floods the packet only to those ports which belong to the same VLAN as the port on which the packet was received. This prevents packets from being forwarded into inappropriate LAN segments, increasing network security. When the destination end node responds, the switch adds its MAC address and port number to the table.

If the switch receives a packet with a destination address that is on the same port on which the packet was received, it discards the packet without forwarding it on to any port. Because both the source end node and the destination end node for the packet are located on the same port on the switch, there is no reason for the switch to forward the packet.

### **Duplex Mode**

Duplex mode refers to the manner in which an end node receives and



transmits data. If an end node can receive or transmit data, but not both simultaneously, the end node is operating in what is referred to as half-duplex mode. If an end node can both receive and transmit data simultaneously, the end node is said to be operating in full-duplex mode. Naturally, an end node capable of operating in full-duplex can handle data much faster than an end node that can only operate in half-duplex mode.

The twisted pair ports on the AT-8500 Series switches can operate in either half- or full-duplex mode. The twisted pair ports are IEEE 802.3u-compliant and will Auto-Negotiate the duplex mode setting for you.

By allowing the switch to configure the duplex mode for each port, you will not need to change the setting for a port on the switch should you replace an end node with an end node that has a different duplex mode capability. With Auto-Negotiation, the switch automatically resets the port to a new duplex mode setting.

If desired, you can disable Auto-Negotiation on the switch ports so that you can set the duplex mode manually through the switch's management software.

---

**Note**

In order for a switch port to successfully Auto-Negotiate its duplex mode with an end node, the end node should also be using Auto-Negotiation. Otherwise, a duplex mode mismatch can occur. A switch port, using Auto-Negotiation, defaults to half-duplex if it detects that the end node is not using Auto-Negotiation. This results in a mismatch if the end node is operating at a fixed duplex mode of full-duplex.

Consequently, when you connect an end node with a fixed duplex mode of full-duplex to a switch port, you should use the AT-S62 management software to disable Auto-Negotiation on the port and set the port speed and duplex mode manually.

---

**Store and Forward**

These Fast Ethernet switches use store and forward as the method for receiving and transmitting frames. When an Ethernet frame is received on a switch port, the switch does not retransmit the frame out the destination port until it has received the entire frame and stored the frame in a port buffer. It then examines the frame to determine if it is a valid frame. Invalid frames, such as fragments or runts, are discarded by the switch. This ensures that only valid frames are transmitted out the switch ports and that damaged frames are not propagated on your network.

**Back Pressure and Flow Control**

To maintain the orderly movement of data between the end nodes, an Ethernet switch may periodically need to signal an end node to stop sending data.

How a switch signals an end node to stop transmitting data differs depending on the speed and duplex mode of the end node and switch port. A twisted pair port operating at 100 Mbps port and half-duplex mode stops an end node from transmitting data by forcing a collision. A collision on an Ethernet network occurs when two end nodes attempt to transmit data using the same data link at the same time. A collision causes end nodes to stop sending data. When the switch needs to stop a 100 Mbps, half-duplex end node from transmitting data, it forces a collision on the data link, which stops the end node. After the switch is ready to receive data again, the switch stops forcing collisions. This is referred to as *back pressure*.

A port operating at 100 Mbps and full-duplex mode uses PAUSE frames, as specified in the IEEE 802.3x standard, to stop the transmission of data from an end node. Whenever the switch wants an end node to stop transmitting data, it issues this frame. The frame instructs the end node to cease transmission. The switch continues to issue PAUSE frames until it is ready again to receive data from the end node. This is referred to as *flow control*.

## Network Topologies

This section illustrates several of the network topologies you can create with the AT-8500 Series Fast Ethernet switch.

### Power Workgroup Topology

The topology shown in Figure 9 is commonly referred to as a power workgroup topology. Each workstation or end node is connected directly to a port on an AT-8524M Fast Ethernet Switch. This provides each end node with a dedicated data link to the switch for best performance and reliability. The devices can operate at either 10 Mbps or 100 Mbps.

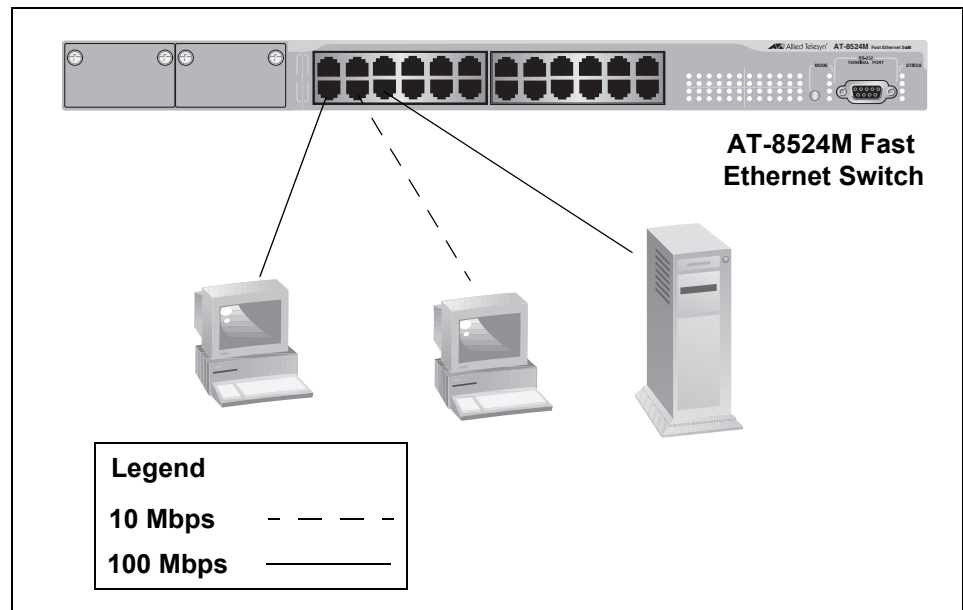

Figure 9. Power Workgroup Topology

### Collapsed Backbone Topology

In the topology illustrated in Figure 10, an AT-8524M Fast Ethernet Switch connects together 10/100 Mbps Ethernet hubs. This type of topology is often referred to as a collapsed backbone topology. The switch functions as the focal point of the network by acting as a bridge between the different workgroups. The switch transfers an Ethernet frame from hub to hub only when the destination end node for the frame is on a different hub than the end node that originated the frame. This reduces the amount of unnecessary data traffic in each workgroup, freeing up bandwidth and improving network performance.

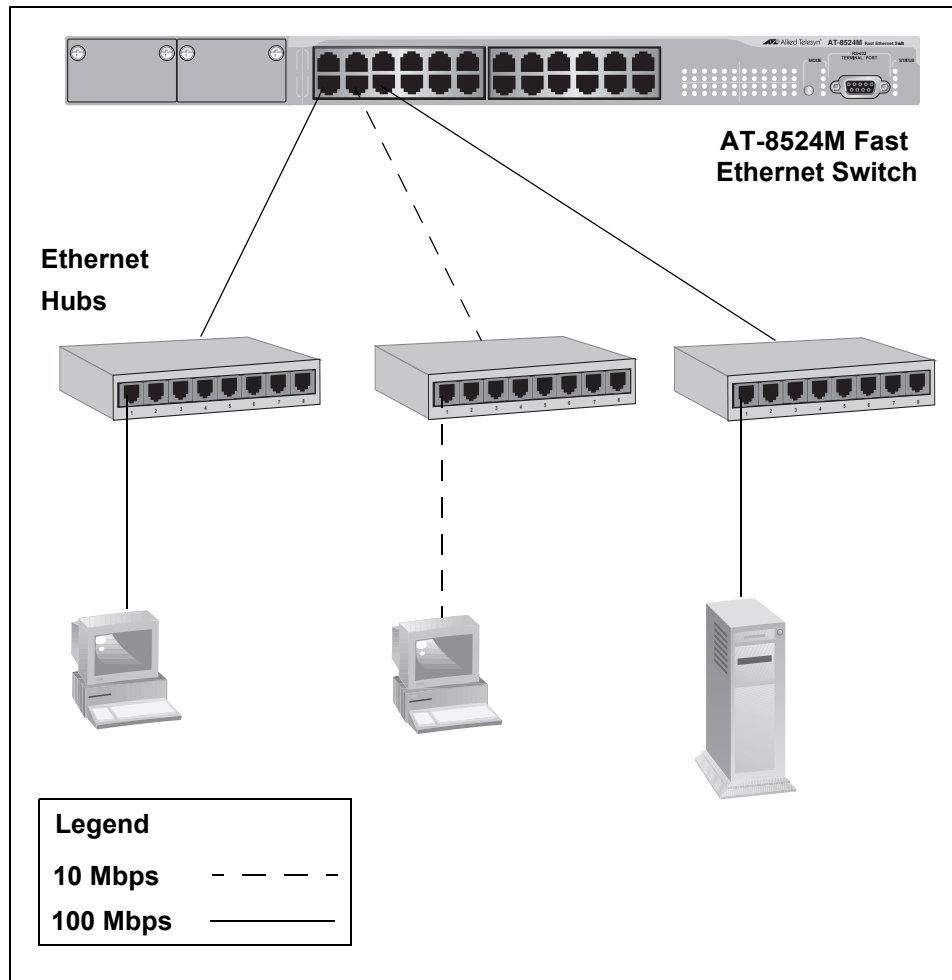

Figure 10. Collapsed Backbone Topology

### Mixed Topology

You can always combine topologies as well as build a larger network by connecting different switches together. If the switches are within 100 meters (328 feet) of each other, you can use the twisted pair ports. If the switches are further apart, then you can use fiber optic ports.

Figure 11 illustrates a network of three AT-8524M Fast Ethernet switches. The workstations and servers on the network are connected either directly to a switch or indirectly through an Ethernet hub. The switches themselves are connected together through 1000Base fiber optic ports on AT-A45/SC expansion modules, creating a high-speed backbone.

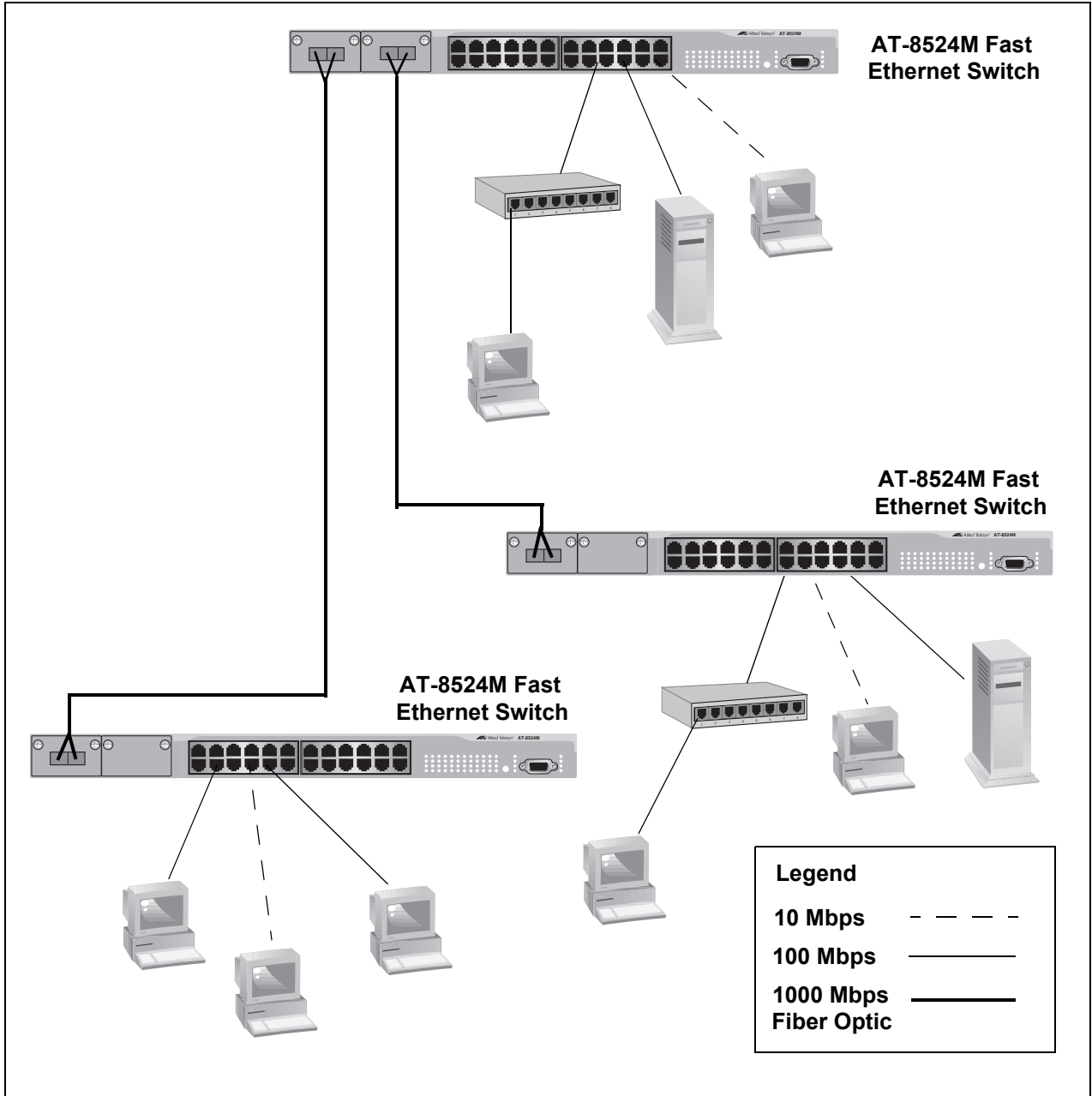

Figure 11. Mixed Topology



## Chapter 2

# Installation

---

This chapter provides the installation procedures for the switch and contains the following sections:

- ❑ “Reviewing Safety Precautions” on page 48
- ❑ “Selecting a Site for the Switch” on page 51
- ❑ “Planning the Installation” on page 52
- ❑ “Unpacking the Switch” on page 54
- ❑ “Installing the Switch in a Rack” on page 55
- ❑ “Installing an Optional Expansion or Stacking Module” on page 58
- ❑ “Installing an Optional GBIC” on page 60
- ❑ “Installing an Optional SFP Transceiver” on page 62
- ❑ “Cabling the Switch” on page 64
- ❑ “Powering on an AC Powered Switch” on page 68
- ❑ “Wiring and Powering on an DC Powered Unit” on page 70
- ❑ “Starting a Local Management Session” on page 73
- ❑ “Warranty Registration” on page 75

---

**Note**

To install an optional redundant power supply, refer to the installation guide included with the unit.

---

## Reviewing Safety Precautions

---

Please review the following safety precautions before you begin to install the chassis or any of its components.

---

### Note

The  indicates that a translation of the safety statement is available in a PDF document titled “Translated Safety Statements” (613-000405) on the Allied Telesis website at [www.alliedtelesis.com](http://www.alliedtelesis.com).

---



**Warning:** To prevent electric shock, do not remove the cover. No user-serviceable parts inside. This unit contains hazardous voltages and should only be opened by a trained and qualified technician. To avoid the possibility of electric shock, disconnect electric power to the product before connecting or disconnecting the LAN cables.  E1

---



**Warning:** Do not work on equipment or cables during periods of lightning activity.  E2

---



**Warning:** Power cord is used as a disconnection device. To de-energize equipment, disconnect the power cord.  E3

---



**Warning:** Class I Equipment. This equipment must be earthed. The power plug must be connected to a properly wired earth ground socket outlet. An improperly wired socket outlet could place hazardous voltages on accessible metal parts.  E4

---

Pluggable Equipment. The socket outlet shall be installed near the equipment and shall be easily accessible.  E5

---



**Caution:** Air vents must not be blocked and must have free access to the room ambient air for cooling.  E6

---

**Warning:** Operating Temperature. This product is designed for a maximum ambient temperature of 40° degrees C.  E7

---

All Countries: Install product in accordance with local and National Electrical Codes.  E8

---





**Warning:** As a safety precaution, install a circuit breaker with a minimum value of 15 Amps between the equipment and the DC power source.

Always connect the wires to the LAN equipment first before you connect the wires to the circuit breaker. Do not work with HOT feeds to avoid the danger of physical injury from electrical shock. Always be sure that the circuit breaker is in the OFF position before connecting the wires to the breaker. *↻* E9

---



**Warning:** Do not strip more than the recommended amount of wire. Stripping more than the recommended amount can create a safety hazard by leaving exposed wire on the terminal block after installation. *↻* E10

---



**Warning:** When installing this equipment, always ensure that the frame ground connection is installed first and disconnected last. *↻* E11

---



**Warning:** Check to see if there are any exposed copper strands coming from the installed wire. When this installation is done correctly there should be no exposed copper wire strands extending from the terminal block. Any exposed wiring can conduct harmful levels of electricity to persons touching the wires. *↻* E12

---

This system works with positive grounded or negative grounded DC systems. *↻* E13

---

**Circuit Overloading:** Consideration should be given to the connection of the equipment to the supply circuit and the effect that overloading of circuits might have on overcurrent protection and supply wiring. Appropriate consideration of equipment nameplate ratings should be used when addressing this concern. *↻* E21

---

A tray cable is required to connect the power source if the unit is powered by centralized DC power. The tray cable must be a UL listed Type TC tray cable and rated at 600 V and 90 degrees C, with three conductors, minimum 14 AWG. *↻* E24

---



**Warning:** Mounting of the equipment in the rack should be such that a hazardous condition is not created due to uneven mechanical loading. *↻* E25

---



**Warning:** This unit might have more than one power source. To reduce the risk of electric shock, disconnect all power sources before servicing the unit. *↪* E30

---

If installed in a closed or multi-unit rack assembly, the operating ambient temperature of the rack environment may be greater than the room ambient temperature. Therefore, consideration should be given to installing the equipment in an environment compatible with the manufacturer's maximum rated ambient temperature (T<sub>mra</sub>). *↪* E35

---

**Caution:** Installation of the equipment in a rack should be such that the amount of air flow required for safe operation of the equipment is not compromised. *↪* E36

---



**Warning:** Reliable earthing of rack-mounted equipment should be maintained. Particular attention should be given to supply connections other than direct connections to the branch circuits (e.g., use of power strips). *↪* E37

---



**Warning:** To reduce the risk of electric shock, the PoE ports on this product must not connect to cabling that is routed outside the building where this device is located. *↪* E40

---

## Selecting a Site for the Switch

---

Observe the following requirements when choosing a site for your switch:

- ❑ If you plan to install the switch in an equipment rack, check to be sure that the rack is safely secured and that it will not tip over. Devices in a rack should be installed starting at the bottom, with the heavier devices near the bottom of the rack.
- ❑ If you are installing the switch on a table, be sure that the table is level and secure.
- ❑ The power outlet for the switch should be located near the unit and should be easily accessible.
- ❑ The site should provide for easy access to the ports on the front of the switch. This will make it easy for you to connect and disconnect cables, as well as to view the switch's LEDs.
- ❑ To allow proper cooling of the switch, air flow around the unit and through its vents on the side and rear should be unrestricted.
- ❑ Do not place objects on top of the switch.
- ❑ Do not expose the switch to moisture or water.
- ❑ Make sure that the site is a dust-free environment.
- ❑ You should use dedicated power circuits or power conditioners to supply reliable electrical power to the network devices.

## Planning the Installation

---

Table 10 contains the cabling specifications for the twisted pair ports.

Table 10. Twisted Pair Cabling and Distances

Model	Speed	Cable Type	Maximum Operating Distance
AT-8524M AT-8524POE AT-8550GB AT-8550SP	10 Mbps	Category 3 or better 100-ohm shielded or unshielded twisted pair cable	100 m (328 ft)
	100 Mbps	Category 5 or Category 5E (Enhanced) 100-ohm shielded or unshielded twisted pair cable	100 m (328 ft)
AT-8550GB AT-8550SP (Ports 49R and 50R)	1000 Mbps	Category 5 and Category 5E (Enhanced) 100-ohm shielded or unshielded twisted pair cable	100 m (328 ft)

---

### Note

The twisted pair ports on the switch feature auto-MDI/MDI-X. They configured themselves automatically as MDI or MDI-X when connected to an end node. This allows you to use a straight-through twisted pair cable when connecting any type of network device to a port on the switch.

The auto-MDI/MDI-X feature is disabled if you disable Auto-Negotiation on a port and set a port's speed and duplex mode manually using the AT-S62 management software. A port where Auto-Negotiation has been disabled defaults to MDI-X. Disabling Auto-Negotiation may require that you manually configure a port's MDI/MDI-X setting or use a crossover cable.

---



---

### Note

The 10/100/1000Base-T ports, Ports 49R and 50R, on the AT-8550GB and AT-8550SP switches can operate at 1000 Mbps only when set to Auto-Negotiation, which is the default setting. You cannot manually set these ports to 1000 Mbps.

---

Table 11 contains the cabling specifications for the fiber optic ports on an AT-8516F/SC switch.

Table 11. Fiber Optic Cabling and Distances

Model	Speed	Cable Type	Maximum Operating Distance
AT-8516F/SC	100 Mbps	50/125 or 62.5/125 micron (core/cladding) multimode fiber optic cable	Full-duplex mode: 2 km (1.25 mi) Half-duplex mode: 412 m (1,360 ft)

---

**Note**

For cabling specifications for an optional GBIC module, SFP module, expansion module, or stacking module, refer to the installation guide included with the option.

---

## Unpacking the Switch

---

To unpack the switch, perform the following procedure:

1. Remove all components from the shipping package.

---

**Note**

Store the packaging material in a safe location. You must use the original shipping material if you need to return the unit to Allied Telesis.

---

2. Place the switch on a level, secure surface.
3. Make sure the following hardware components are included in your switch package. If any item is missing or damaged, contact your Allied Telesis sales representative for assistance.
  - One AT-8500 Series Fast Ethernet Switch
  - Two mounting brackets
  - Eight flathead Phillips screws (All models except the AT-8524POE switch)
  - Twelve flathead Phillips screws (AT-8524POE switch only)
  - AC power cord (AC switches only; Americas, EC, Australia, and UK only)
  - Management cable for local management
  - Documentation CD
  - Warranty card

## Installing the Switch in a Rack

The switch is shipped with two brackets for mounting the unit in a rack. The brackets can be attached to the chassis four ways. You can install the chassis so that it is flush with the front of the rack or so that it extends forward from the rack. Figure 12 illustrates the different ways that you can install the brackets and how much the chassis extends from the front of the rack.

- Method A - Flush with front of rack
- Method B - 4.5cm (1.75 in.)
- Method C - 18.4 cm (7.25 in.)
- Method D - 21.6 cm (8.5 in)

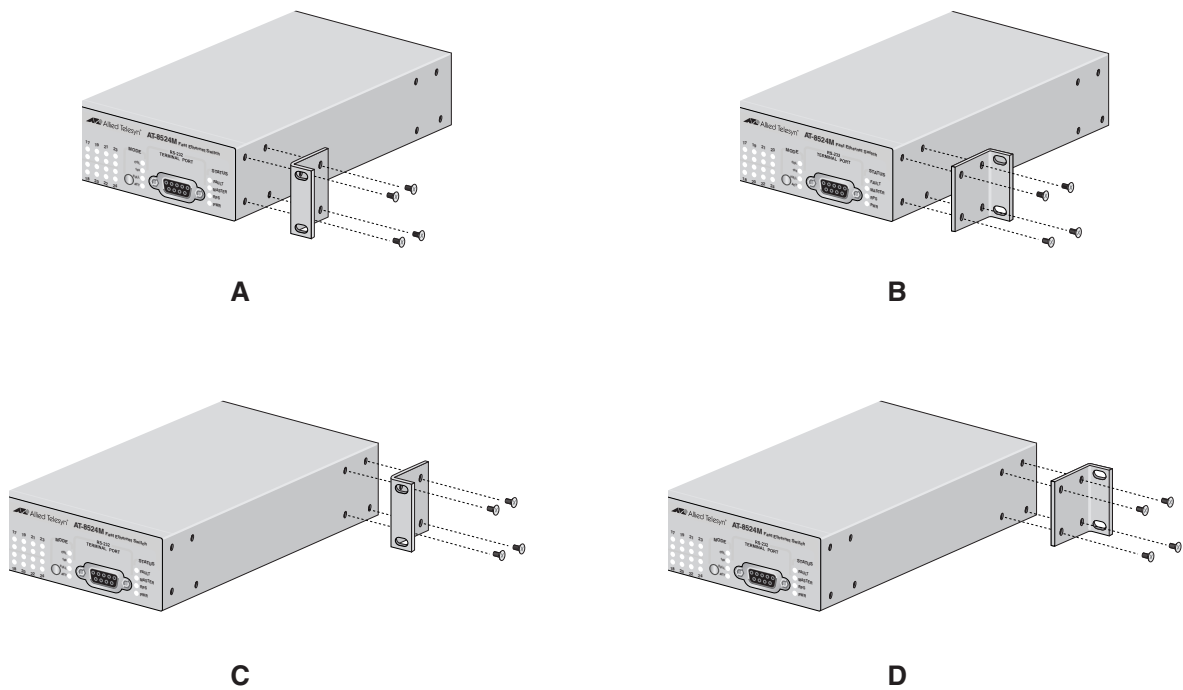

Figure 12. Rack Mount Bracket Positions

---

### Note

The AT-8524POE switch only supports Method A.

---

Perform the following procedure to install the switch in a standard 19-inch rack. If you are not installing the switch in a rack, proceed to “Installing an Optional GBIC” on page 60.

1. Place the unit upside down on a level, secure surface.

- Using a flat-head screwdriver, remove the snap-on plastic feet from the bottom of the switch, as shown in Figure 13.

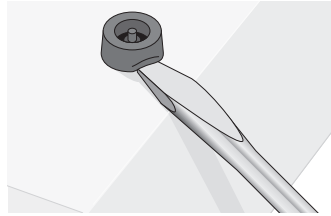

Figure 13. Removing the Feet

- Turn the switch over.
- Attach a rackmounting bracket to one side of the switch using four of the screws that came with the switch. You can install the brackets in one of four ways, as shown in Figure 12.
- Install the second rackmounting bracket on the other side of the switch using the four remaining screws.
- Mount the switch in the 19-inch rack using standard screws (not provided).



**Warning:** To prevent electric shock, do not remove the cover. No user-serviceable parts inside. This unit contains hazardous voltages and should only be opened by a trained and qualified technician. To avoid the possibility of electric shock, disconnect electric power to the product before connecting or disconnecting the LAN cables. ⚡ E1

---



**Warning:** Do not work on equipment or cables during periods of lightning activity. ⚡ E2

---



**Warning:** Power cord is used as a disconnection device. To de-energize equipment, disconnect the power cord. ⚡ E3

---



**Warning:** Class I Equipment. This equipment must be earthed. The power plug must be connected to a properly wired earth ground socket outlet. An improperly wired socket outlet could place hazardous voltages on accessible metal parts. ⚡ E4

---

Pluggable Equipment. The socket outlet shall be installed near the equipment and shall be easily accessible. ⚡ E5

---





---

**Caution:** Air vents must not be blocked and must have free access to the room ambient air for cooling. *↪* E6

---

**Warning:** Operating Temperature. This product is designed for a maximum ambient temperature of 40° degrees C. *↪* E7

---

Circuit Overloading: Consideration should be given to the connection of the equipment to the supply circuit and the effect that overloading of circuits might have on overcurrent protection and supply wiring. Appropriate consideration of equipment nameplate ratings should be used when addressing this concern. *↪* E21

---

**Warning:** Mounting of the equipment in the rack should be such that a hazardous condition is not created due to uneven mechanical loading. *↪* E25

---

If installed in a closed or multi-unit rack assembly, the operating ambient temperature of the rack environment may be greater than the room ambient temperature. Therefore, consideration should be given to installing the equipment in an environment compatible with the manufacturer's maximum rated ambient temperature (T<sub>mra</sub>). *↪* E35

---

**Caution:** Installation of the equipment in a rack should be such that the amount of air flow required for safe operation of the equipment is not compromised. *↪* E36

---



**Warning:** Reliable earthing of rack-mounted equipment should be maintained. Particular attention should be given to supply connections other than direct connections to the branch circuits (e.g., use of power strips). *↪* E37

---

## Installing an Optional Expansion or Stacking Module

---

This section describes how to install an optional expansion or stacking module in the switch and applies to the AT-8516F/SC, AT-8524M, and AT-8524POE models.

---

**Note**

The modules can be hot-swapped; you do not have to power off a switch to install these options.

---

To install a module, perform the following procedure:

1. Remove the module from its shipping container and store the packaging material in a safe location.

---

**Note**

You must use the original shipping material if you need to return the module to Allied Telesis.

---

---

**Warning**

An expansion or stacking module can be damaged by static electricity. Be sure to observe all standard electrostatic discharge (ESD) precautions, such as wearing an antistatic wrist strap, to avoid damaging the module.

---

Refer to the module's installation guide for a list of the items included with the option. If any item is missing or damaged, contact your Allied Telesis sales representative for assistance.

2. Locate the expansion slots on the left side of switch.
3. Using a Phillips screwdriver, loosen the captive screws on the faceplate and remove it, as shown in Figure 14.

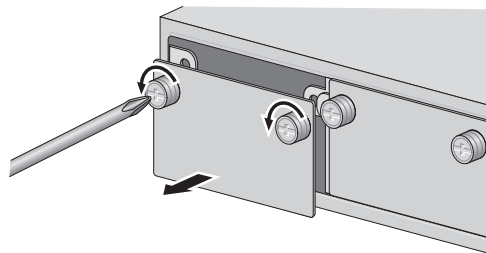

Figure 14. Removing the Expansion Slot Faceplate

4. Pull the faceplate straight out of the slot.
5. Keep the faceplate in a safe area in case you need to reinstall it.

The faceplate keeps any dust from getting into the switch and maintains proper airflow if the slot remains empty.

6. Carefully slide the module into the slot until the module faceplate makes contact with the switch, as shown in Figure 15.

Avoid touching the module components.

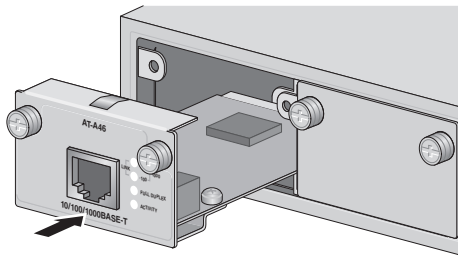

Figure 15. Installing a Module

7. Using a Phillips screwdriver, tighten the captive screws, as shown in Figure 16, to secure the module in the switch.

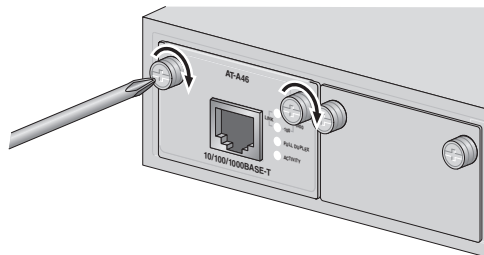

Figure 16. Securing the Module in the Expansion Slot

---

**Caution**

Always use the captive screws to secure the module to the switch. Leaving a module partially seated may cause the system to halt and subsequently crash.

---



---

**Note**

When you remove a module, store the device in an antistatic bag or immediately install it in another switch.

---

## Installing an Optional GBIC

---

To install an optional GBIC in an AT-8550GB switch, perform the following procedure:

---

**Note**

A GBIC can be hot-swapped; you do not have to power off a switch to install it.

---

1. Remove the GBIC from its shipping container and store the packaging material in a safe location.

---

**Note**

You must use the original shipping material if you need to return the module to Allied Telesis.

---

---

**Warning**

A GBIC can be damaged by static electricity. Be sure to observe all standard electrostatic discharge (ESD) precautions, such as wearing an antistatic wrist strap, to avoid damaging the module.

---

2. Check that the GBIC package includes all the items listed below.

If any item is missing or damaged, contact your Allied Telesis sales representative for assistance.

- One GBIC module
- Installation Guide
- Warranty card

---

**Note**

For fiber optic cabling specifications, refer to the GBIC installation guide provided with your module.

---

3. Follow these guidelines to ensure proper performance of your GBIC:
  - GBIC modules are dust sensitive. When the GBIC is stored or when a fiber-optic cable is not plugged in, always keep plugs in the GBIC optical bores.
  - The most common source of contaminants in the optical bore is debris picked up on the ferrules of the optical connectors, as shown in Figure 17. Use an alcohol swab or wipe to clean the

ferrules of the optical connector.

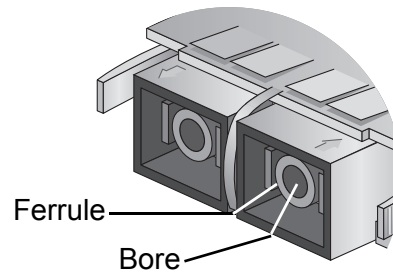

Figure 17. Optical Bore and Ferrule of GBIC Module

---

**Note**

Unnecessary removal and insertion of a GBIC can lead to premature failure.

---

4. Slide the GBIC module, with the label side up, into an expansion slot on the switch, as shown in Figure 18.

The GBIC can be installed in either slot. The GBIC module is seated in the slot when it clicks into place.

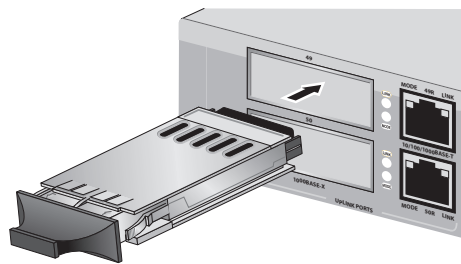

Figure 18. Installing a GBIC Module

5. If you purchased two GBIC modules for the switch, repeat this procedure to install the second module.

---

**Note**

Unnecessary removal and insertion of a GBIC can lead to premature failure.

---

## Installing an Optional SFP Transceiver

---

To install an optional SFP transceiver in an AT-8550SP switch, perform the following procedure:

---

**Note**

An SFP transceiver can be hot-swapped; you do not have to power off a switch to install it.

---

1. Unpack the SFP transceiver from its shipping container and store the packaging material in a safe location.

---

**Note**

You must use the original shipping material if you need to return the module to Allied Telesis.

---

---

**Warning**

An SFP transceiver can be damaged by static electricity. Be sure to observe all standard electrostatic discharge (ESD) precautions, such as wearing an antistatic wrist strap, to avoid damaging the module.

---

2. Check that the SFP transceiver includes the items listed below. If any item is missing or damaged, contact your Allied Telesis sales representative for assistance.

- One SFP module
- Installation Guide
- Warranty card

---

**Note**

For fiber optic cabling specifications, refer to the SFP installation guide provided with the module.

---

3. Follow these guidelines to ensure proper performance of your SFP transceiver:
  - SFP transceivers are static sensitive. To prevent Electrostatic Discharge (ESD) damage, follow your normal board and component handling procedures.
  - SFP transceivers are dust sensitive. Do not remove the dust cover from the port until you are ready to attach the fiber optic cable.
  - The most common source of contaminants in the optical bore is

debris picked up on the ferrules of the optical connectors. Use an alcohol swab or wipe to clean the ferrules of the optical connector.

---

**Note**

Unnecessary removal and insertion of an SFP transceiver can lead to premature failure.

---

4. Remove the dust plug from the SFP slot.
5. Locate the label on the transceiver and turn it so that the label is on top and the alignment groove is on the bottom.
6. Slide the SFP transceiver into an SFP slot on the switch.

The SFP module can be installed in either slot. The SFP module is seated in the slot when it clicks into place.

---

**Note**

SFP transceivers are dust sensitive. When a fiber optic cable is not installed, or when you store the SFP, always keep the plug in the slot. When you do remove the plug, keep it for future use.

---

---

**Note**

Unnecessary removal and insertion of an SFP transceiver can lead to premature failure.

---

7. If you purchased two SFP transceivers for the switch, repeat this procedure to install the second transceiver.

For information about cabling for the SFP transceiver, consult the documentation that was shipped with the SFP.

## Cabling the Switch

---

To connect the data cables to the switch ports and to apply power to the switch, perform the following procedure:

### Cabling Twisted Pair Ports

If your AT-8500 Series switch has twisted pair ports, perform the following procedure:

1. Connect the twisted pair data cables to the RJ-45 ports on the switch, as shown in Figure 19.

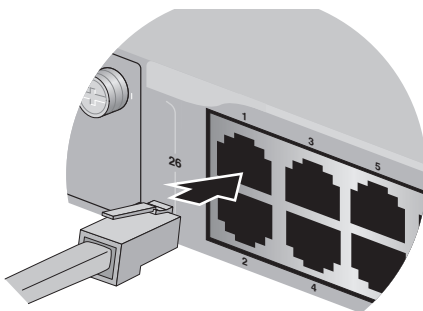

Figure 19. Connecting the Twisted Pair Data Cables

When you connect a twisted pair cable to a port, observe the following guidelines:

- ❑ An RJ-45 connector should fit snugly into the port on the switch. The tab on the connector should lock the connector into place.
- ❑ Because the ports on the switch are auto-MDI/MDI-X, you can use either a straight-through or crossover twisted pair cable to connect any type of network device to a port on the switch. If you disable Auto-Negotiation on a port, the auto-MDI/MDI-X feature is disabled and the port defaults to MDI-X. For instructions on how to configure a port, refer to the *AT-S62 Management Software User's Guides*.
- ❑ If your network topology will contain a loop where two or more network devices can communicate with each other over more than one data path, do not connect the network cables forming the loop until after you have activated a spanning tree protocol on the switch. Data loops can adversely affect network performance. For information on spanning tree, refer to the *AT-S62 Management Software User's Guides*.
- ❑ If you are creating a port trunk, do not connect the cables of the trunk to the switch until after you have configured the trunk using the switch's management software. Connecting the trunk cables to the switch before you have configured the software will result in a data loop, which can adversely affect network performance. For



instructions on how to configure a port trunk, refer to the *AT-S62 Management Software User's Guides*.

- When you connect a device to a port on an AT-8524POE switch, the port automatically determines whether the node is a powered device and, if it is, the amount of wattage required by the device, up to a maximum of 15.4 W. If the node is not a powered device, the port automatically disables the PoE feature.



### Warning

To reduce the risk of electric shock, the PoE ports on this product must not connect to cabling that is routed outside the building where this device is located. *E40*

---

## Cabling Fiber Optic Ports

If your switch has fiber optic ports, perform the following procedure:

1. Remove the dust covers from the ports, as shown in Figure 20.

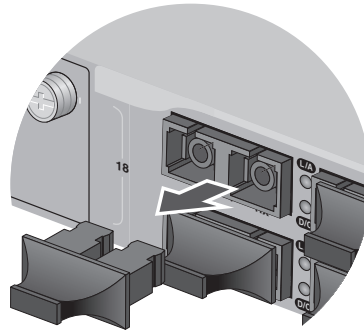

Figure 20. Removing the Dust Covers from the Fiber Optic Ports

---

### Note

Do not remove the dust covers if you do not intend to connect the fiber optic cables at this time. Dust contamination can adversely impact the operation of the ports.

---

2. Attach the fiber optic data cables to the fiber optic ports, as shown in Figure 21.

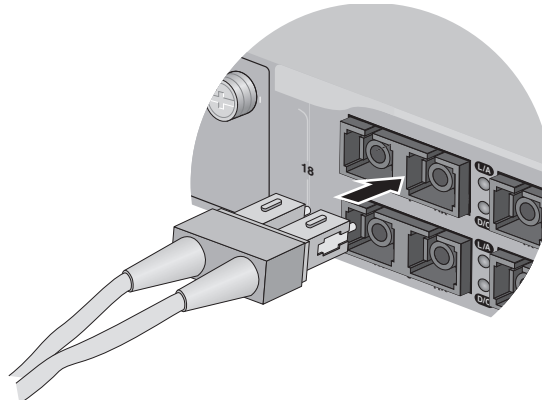

Figure 21. Attaching a Fiber Optic Cable

When you attach a fiber optic cable, be sure to observe the following guidelines:

- ❑ Be sure that the cable connector is firmly locked into place in the port.
- ❑ A dual SC port consists of two separate connectors, as shown in Figure 22. Each connects to a separate fiber strand. One is for receiving packets and the other is for transmitting packets. When you connect a fiber optic cable to a dual SC port, be sure that the receiver fiber connector is connected to the transmitter connector on the remote end node, and the transmitter fiber connector is connected to the receiver connector on the remote node.

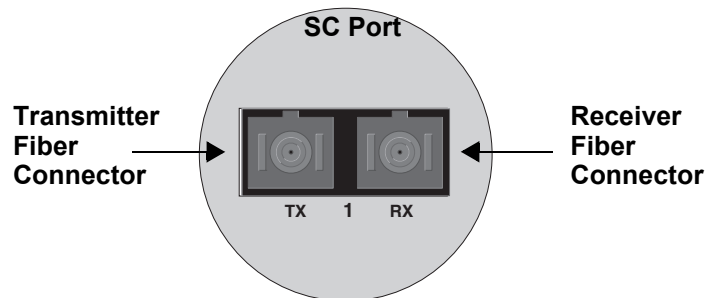

Figure 22. Dual SC Port

- ❑ You should verify that you are using the appropriate type of fiber optic cabling. For an AT-8516F/xx Series switch, refer to “Planning the Installation” on page 52. For an optional GBIC module, refer to the GBIC installation guide. For an optional fiber optic expansion module, refer to the expansion module installation guide.
- ❑ You should verify that the operating specifications of the switch’s fiber optic port are compatible with the fiber optic port on the

remote end node. For example, you cannot connect a fiber optic port with a maximum distance of 2 kilometers and an operating wavelength of 1310 nm to another fiber optic port that has a maximum distance of 40 kilometers (24.8 miles) and an operating wavelength of 1550 nm. For fiber optic ports specifications, refer to “AT-8516F/SC Fiber Optic Port Specifications” on page 85.

- ❑ If your network topology will contain a loop where two or more network devices can communicate with each other over more than one data path, do not connect the network cables forming the loop until after you have activated a spanning tree protocol on the switch. Data loops can adversely affect network performance. For information on spanning tree, refer to the *AT-S62 Management Software User's Guides*.
- ❑ If you are creating a port trunk, do not connect the cables of the trunk to the switch until you after have configured the trunk using the switch's management software. Connecting the trunk cables to the switch before you have configured the software will result in a data loop, which can adversely affect network performance. For instructions on how to configure a port trunk, refer to the *AT-S62 Management Software User's Guides*.

## **Cabling Expansion Modules**

If you installed a fiber optic or twisted pair expansion module, stacking module, GBIC module, or SFP module, connect the data cable to the port on the module.

## Powering on an AC Powered Switch

---

To power on an AC powered switch, perform the following procedure:

---

**Note**

If you are installing a DC powered switch, go to “Wiring and Powering on an DC Powered Unit” on page 70.

---

1. Select the correct power cord for your country.
2. Plug the power cord into the AC power connector on the back panel of the switch, as shown in Figure 23.

**Warning**

The power cord is used as a disconnection device. To de-energize equipment, disconnect the power cord. *GE* E3

---

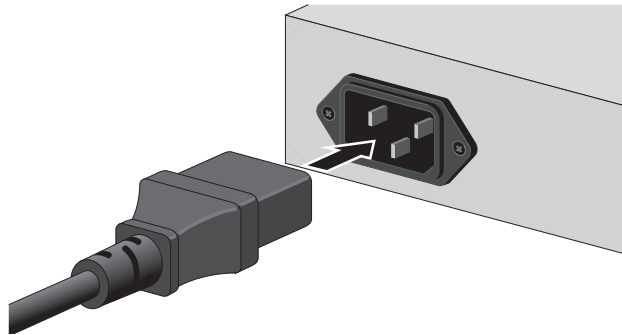

Figure 23. Connecting the AC Power Cord

3. Plug the other end of the power cord into a wall outlet.

When power is applied, the switch begins to load the AT-S62 software. The loading process takes approximately 20 to 30 seconds to complete.

4. If you installed an optional redundant power supply unit, connect one end of the DC power cord included with the RPS unit to the back panel of the redundant power supply and the other end to the RPS connector on the back panel of the switch, as shown in Figure 24.

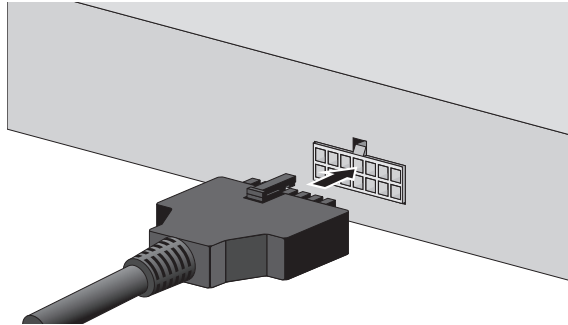

Figure 24. Connecting the RPS DC Cable

5. Verify that the PWR LED on the front of the unit is green. If the PWR LED is OFF, refer to Chapter 3, “Troubleshooting” on page 77.

The switch runs a series of self-diagnostic tests, which take a few seconds to perform. After the self tests are complete, the switch is ready for normal network operations.



#### **Warning**

This unit might have more than one power cord. To reduce the risk of electric shock, disconnect all power cords before servicing the unit. *GE* E30

No further installation steps are required if you do not intend to change the default operating parameter settings of the switch, which are listed in the *AT-S62 Management Software User's Guide*. However, if you want to manage the switch, refer to “Starting a Local Management Session” on page 73.

## Wiring and Powering on an DC Powered Unit

To provide power for a DC powered switch, perform the following steps:

1. Before you attach wires to the DC terminal block at the rear of the switch, review the following warning:



### Warning

As a safety precaution, install a circuit breaker with a minimum value of 15 Amps between the equipment and the DC power source.

Always connect the wires to the LAN equipment first before you connect the wires to the circuit breaker. Do not work with HOT feeds to avoid the danger of physical injury from electrical shock. Always be sure that the circuit breaker is in the OFF position before connecting the wires to the breaker. *⚡* E9

A tray cable is required to connect the power source if the unit is powered by centralized DC power. The tray cable must be a UL listed Type TC tray cable and rated at 600 V and 90 degrees C, with three conductors, minimum 14 AWG. *⚡* E24

2. On the rear side of the chassis is a DC terminal block. Starting from the left side of the terminal block, identify the **positive**, **frame ground**, and **negative** terminals using the symbols beneath the terminal block or the illustration in Figure 25.

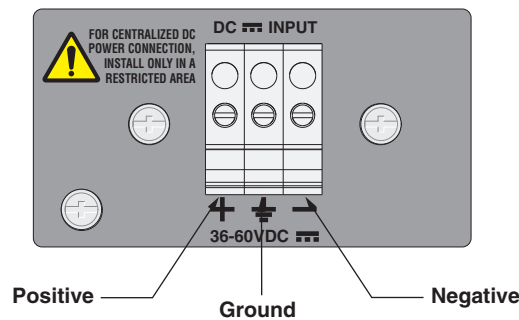

Figure 25. Positive, Ground, and Negative Terminals

3. With a 14-gauge wire-stripping tool, strip the three wires in the tray cable coming from the DC input power source to 8mm  $\pm$  1mm (0.31 in.,  $\pm$  0.039 in.).

**Warning**

Do not strip more than the recommended amount of wire. (See Figure 26.) Stripping more than the recommended amount can create a safety hazard by leaving exposed wire on the terminal block after installation. ⚡ E10

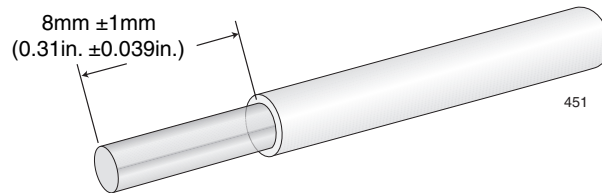

Figure 26. Stripped Wire

4. Connect the **frame ground** wire to the terminal marked with the ground symbol by inserting the wire into the terminal and tightening the connection with a flathead screwdriver, as shown in Figure 27.

**Warning**

When installing this equipment, always ensure that the frame ground connection is installed first and disconnected last. ⚡ E11

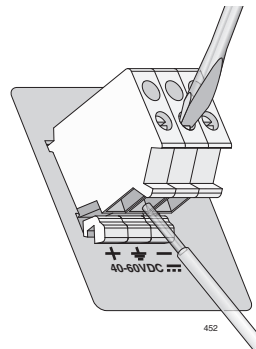

Figure 27. Connecting the Stripped Wire

5. Connect the **positive** feed wire to the terminal block marked (+).
6. Connect the **negative** feed wire to the terminal block marked (-).

**Warning**

Check to see if there are any exposed copper strands coming from the installed wires. When this installation is done correctly there should be no exposed copper wire strands extending from the terminal block. Any exposed wiring can conduct harmful levels of electricity to persons touching the wires. ⚡ E12

7. Secure the tray supply cable near the rack framework using multiple cable ties to minimize the chance of the connections being disturbed by casual contact with the wiring. Use at least four cable ties separated four inches apart with the first one located within six inches of the terminal block.

---

This system works with a positive grounded or negative grounded DC system.  E13

---

8. Ensure that the circuit breaker is in the Off position.
9. Connect the DC wires to the circuit breaker. (Refer “Power Specifications” on page 82 for power requirements.)
10. Power on the circuit breaker.
11. Verify that the PWR LED on the front of the unit is green. If the PWR LED is OFF, refer to Chapter 3, “Troubleshooting” on page 77.

The switch runs a series of self-diagnostic tests, which take a few seconds to perform. After the self tests are complete, the switch is ready for normal network operations.



---

**Warning**

This unit might have more than one power cord. To reduce the risk of electric shock, disconnect all power cords before servicing the unit.  E30

---

No further installation steps are required if you do not intend to change the default operating parameter settings of the switch, which are listed in the *AT-S62 Management Software User's Guide*. However, if you want to manage the switch, refer to “Starting a Local Management Session” on page 73.



## Starting a Local Management Session

The procedure in this section explains how to start a local (out-of-band) management session using the RS-232 terminal port on the switch. You can use a local management session to configure the switch's operating parameters and view performance and error statistics.

### Note

If you already installed an AT-8500 Series Switch, AT-8400 Series Switch, or AT-8000 Series Switch on your network and configured it as a Master switch of an enhanced stack, you can begin to remotely manage the new switch you have just installed by connecting, locally or remotely, to the Master switch and then using the enhanced stacking feature to access the new switch. For instructions, refer to the *AT-S62 Management Software User's Guides*.

To start a local management session, perform the following procedure:

1. Connect one end of the RS-232, straight-through management cable included with the AT-8500 Series switch to the RS-232 terminal port on the switch. (See Figure 28.) This port is located on the front panel on the AT-8516F/SC, AT-8524M, and AT-8524POE switches and on the back panel of the AT-8550GB and AT-8550SP switches.

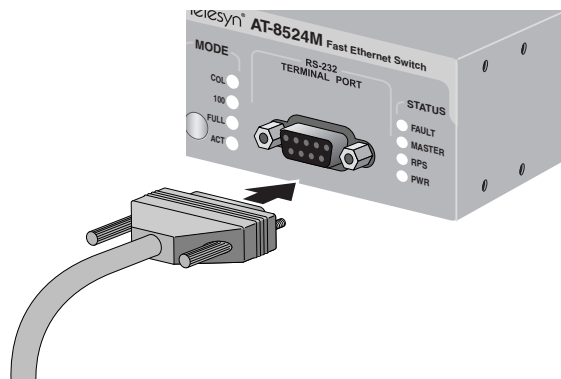

Figure 28. Connecting an RS-232 Cable to the RS-232 Terminal Port on an AT-8524M Switch

2. Connect the other end of the cable to an RS-232 port on a terminal or a personal computer with a terminal emulation program.
3. Set the terminal or the terminal emulation program to the following settings:
  - Baud rate: 9600 bps
  - Data bits: 8

- Parity: None
- Stop bits: 1
- Flow control: None

---

**Note**

The port settings are for a DEC VT100 or ANSI terminal, or an equivalent terminal emulator program.

---

---

**Note**

When you reset or power cycle the switch during a local management session, you will see the following prompt: `Press <CTRL>B to go to Boot Prompt`. This message is intended for manufacturing purposes only. If you inadvertently display the boot prompt (`=>`), type **boot** and press Return to start the switch.

---

4. Press Return.

You are prompted for a user name and password.

5. To view and configure all of the switch's operating parameters, enter the login name "manager". The default password for manager access is "friend". To only view the parameter settings, enter the login name "operator". The default password for operator access is "operator". The user names and passwords are case-sensitive.

The Main Menu is displayed.

If you logged in with manager access, you can now fully manage the switch using the management interface. For instructions, refer to the *AT-S62 Management Software User's Guides*. The guides are available from the Allied Telesis web site at [www.alliedtelesis.com](http://www.alliedtelesis.com) and on the CD included with the switch.

## Warranty Registration

---

When you have finished installing the switch, fill out the enclosed warranty card and mail it to Allied Telesis.



## Chapter 3

# Troubleshooting

---

This chapter contains information on how to troubleshoot the switch in the event that a problem occurs.

---

If after following the instructions in this chapter you are unable to resolve the problem, contact Allied Telesis Technical Support for assistance. Refer to “Contacting Allied Telesis” on page 14 for contact information.

---

## PWR LED is Off

---

Check the PWR LED on the front of the switch. If the LED is OFF, indicating that the unit is not receiving power, do the following:

- Make sure that the power cord is securely connected to the power source and to the AC connector on the back panel of the switch.
- Verify that the power outlet has power by connecting another device to it.
- Try connecting the unit to another power source.
- Try using a different power cord.
- Check that the voltage from the power source is within the required levels for your region.

## Twisted Pair Port Link LED is Off

---

For twisted pair ports, verify that the LINK LED for each port is ON. If a Link LED is OFF, do the following:

- Verify that the end node connected to the port is powered ON and is operating properly.
- Check that the twisted pair cable is securely connected to the port on the switch and to the port on the end node.
- Make sure that the twisted pair cable does not exceed 100 m (328 ft).

- ❑ Verify that you are using the appropriate category of twisted pair cable: Category 3 or better for 10 Mbps operation and Category 5 and Category 5E for 100 Mbps and 1000 Mbps operations.
- ❑ Determine if a crossover cable is required. Since the twisted pair ports feature auto MDI/MDI-X, you should be able to use a straight-through cable regardless of the type of device you connect to a port. However, if you disable Auto-Negotiation on a port and set a port's speed and duplex mode manually, the port defaults to MDI-X. For port pinouts, refer to "RJ-45 Twisted Pair Port Pinouts" on page 83.
- ❑ Make sure that the operating parameters of the port on the switch are compatible with the end node to which the port is connected. This may require that you use the switch's management software. For instructions, refer to the *AT-S62 Management Software User's Guides*.

## Fiber Optic Port Link LED is Off

---

For fiber optic ports, verify that the LINK LED for each port is ON. If a LINK LED is OFF, do the following:

- ❑ Verify that the end node connected to the port is powered ON and is operating properly.
- ❑ Check that the fiber optic cable is securely connected to the port on the switch and to the port on the end node.
- ❑ Dual SC ports consist of two separate connectors, as shown in Figure 32 on page 90. Each connects to a separate fiber strand. One is for receiving data and the other is for transmitting data. When connecting a fiber optic cable to an SC port, be sure that the receiver fiber connector is connected to the transmitter connector on the remote end node, and the transmitter fiber connector is connected to the receiver connector on the remote node.
- ❑ Make sure that you are using the appropriate type of fiber optic cable and that the cable length does not exceed the allowed maximum distance. For an AT-8516F Series switch, refer to "Planning the Installation" on page 52 . For an optional GBIC or SPF module, or other expansion module, refer to the Installation Guide shipped with the module.
- ❑ Use a fiber optic tester to test the attenuation on the cable to determine if the strength of the fiber optic signal falls below acceptable limits. (For fiber optic port specifications for an AT-8516F Series Switch, refer to "AT-8516F/SC Fiber Optic Port Specifications" on page 85. For an optional GBIC or SPF module, or other expansion module, refer to the Installation Guide shipped with the module.
- ❑ Check that the operating specifications (for instance, wavelength and maximum operating distance) of the fiber optic port on the remote end node are compatible with the fiber optic port on the switch. For

example, you cannot connect a fiber optic port with a maximum distance of 40 kilometers (24.8 miles) and an operating wavelength of 1550 nm to a remote fiber optic port with an maximum distance of only 2 kilometers (1.24 miles) and a wavelength of 1310 nm.

- ❑ Check to be sure that the fiber optic ports on the switch and on the end node are operating at the same speed and duplex mode.
- ❑ AT-8550GB and AT-8550SP switches only — Verify that the GBIC module or SFP module is completely inserted into the expansion slot on the front of the switch.

---

A 1000Base connection can take from five to ten seconds to establish a link.

---

## PoE Device is Not Receiving Power

---

If you attached a powered device to a port on an AT-8524POE, the PoE LED for the port should be green. (Remember to use the Mode Select button to toggle the Mode LEDs to the PoE state.) If the device is not receiving power or the PoE LED is flashing amber, steady amber, or is OFF, do the following:

- ❑ Check to be sure that the powered device is designed to receive power over pins 1, 2, 3, and 6 on the RJ-45 port. This can be verified by reviewing the device's documentation or data sheet.
- ❑ Check that the device's power requirements do not exceed 15.4 W. This can be verified by reviewing the device's documentation or data sheet.
- ❑ Verify that the twisted pair cable is Category 5 or 5E.
- ❑ Verify that the twisted pair cable is not faulty.
- ❑ Use the AT-S62 management software to determine whether PoE is enabled on the switch and the port. The default setting for PoE is enabled.
- ❑ Use the management software to determine whether the PoE power setting for the port has been reduced from the default setting of 15.4 W, to a value below the power requirements of the device.
- ❑ PoE is not supported on expansion modules.
- ❑ Verify that the power budget on the switch is not being exceeded by the powered devices. This should not be a problem for the AT-8524POE switch, which can support powered devices on all ports 1 to 24, even when all devices require the maximum of 15.4 W.

## Fault LED is On Continuously

---

Check the FAULT LED. During normal operations, the LED remains off, except for periods when the management software is saving a change to its configuration. If it remains on for an extended period, do the following:

- ❑ Try resetting the switch by disconnecting and reconnecting the AC power cord. If the switch is a DC model, reset the unit by powering off and the powering on the DC circuit.
- ❑ If the FAULT LED remains ON, try downloading a new version of the switch's management software through the RS-232 terminal port on the front panel of the switch. For instructions, refer to the switch's software management guide.
- ❑ If the LED remains on even after you have tried the above suggestions, the switch may be having a hardware problem. Contact your Allied Telesis representative for assistance.

## **Cannot Establish a Local Management Session**

---

If you are unable to establish a local management session with the switch through the RS-232 terminal port on the front panel, do the following:

- ❑ Check to be sure that the RS-232 cable is securely connected to the RS-232 terminal port on the switch and to the RS-232 port on the terminal or personal computer.
- ❑ Check to be sure that you are using a straight-through RS-232 cable. Do not use a cross-over cable.
- ❑ Check to be sure that the operating parameters on the terminal or the terminal emulation program, if you are using a personal computer, have been set correctly. The default settings for "Planning the Installation" on page 52 the RS-232 terminal port can be found in. See "Planning the Installation" on page 52.



## Appendix A

# Technical Specifications

---

## Physical Specifications

---

AT-8516F/SC and AT-8524M Dimensions	4.4 cm x 44.0 cm x 22.2 cm (1.75 in. x 17.3 in. x 8.75 in.) (H x W x D)
AT-8550GB and AT-8550SP Dimensions	4.4 cm x 44.0 cm x 25.5 cm (1.75 in. x 17.3 in. x 10.0 in.) (H x W x D)
AT-8524POE Dimensions:	4.4 cm x 43.8 cm x 40.6 cm (1.75 in. x 17.25 in. x 16.0 in.) (H x W x D)
Weight:	
AT-8516F/SC	3.4 kg (7.4 lb.)
AT-8524M	3.2 kg (7.1 lb.)
AT-8524POE	6.0 kg (13.3 lb.)
AT-8550GB	3.6 kg (7.9 lb.)
AT-8550SP	3.5 kg (7.7 lb.)
Recommended Minimum Ventilation on All Sides:	10 cm (4.0 in)

## Environmental Specifications

---

Operating Temperature:	0° C to 40° C (32° F to 104° F)
Storage Temperature:	-25° C to 70° C (-13° F to 158° F)
Operating Humidity:	5% to 90% non-condensing
Storage Humidity:	5% to 95% non-condensing
Maximum Operating Altitude:	4,000 m (13,000 ft)
Maximum Non-operating Altitude:	4,000 m (13,000 ft)

## Power Specifications

---

Input Voltage:

All models except for the AT-8524POE:

AC	100-240 VAC, 2A Max, 50/60 Hz
DC	36-60 VDC, 4A Max

AT-8524POE:

AC	100-240 VAC, 6A Max, 50/60 Hz
----	-------------------------------

AC Input Power Consumption:

All models except AT-8524POE:	74 watts
Only the AT-8524POE:	450 watts

Available Power over Ethernet:	370 W @ 48 VDC
IEEE 802.3af Class 3 (15.4 W):	Max 24 ports
IEEE 802.3af Class 2 (7.3 W):	Max 24 ports
IEEE 802.3af Mode:	Alternative A (MDI)

## Safety and Electromagnetic Emissions Certifications

---

EMI:	FCC Class A, EN55022 Class A, VCCI Class A, C-TICK, EN61000-3-2, EN61000-3-3
------	--

Immunity:	EN55024
-----------	---------

Safety:	UL 60950 (cUL <sub>us</sub> ), EN60950 (TUV)
---------	--

Quality and Reliability:	MTBF > 90,000 hrs, MTTR < 1/2 hr
--------------------------	-------------------------------------

## RJ-45 Twisted Pair Port Pinouts

Figure 29 illustrates the pin layout for an RJ-45 connector and port.

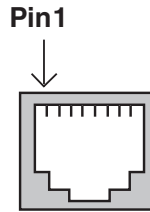

Figure 29. RJ-45 Connector and Port Pin Layout

Table 12 lists the RJ-45 pin signals for the 10/100Base-TX ports on the AT-8524M, AT-8550GB, and AT-8550SP switches.

Table 12. 10/100Base-TX Port MDI/MDI-X Pin Signals

Pin	MDI Signal	MDI-X Signal
1	TX+	RX+
2	TX-	RX-
3	RX+	TX+
4	Unused	Unused
5	Unused	Unused
6	RX-	TX-
7	Unused	Unused
8	Unused	Unused

Table 13 lists the RJ-45 port pin signals on the 10/100Base-TX ports on an AT-8524POE switch.

Table 13. 10/100Base-T Port MDI/MDI-X Pin Signals with PoE

Pin	MDI Signal	MDI-X Signal
1	TX+ and Vport-1 <sup>1</sup>	RX+ and Vport-1
2	TX- and Vport-1	RX- and Vport-1
3	RX+ and Vport-2 <sup>2</sup>	TX+ and Vport-2

Table 13. 10/100Base-T Port MDI/MDI-X Pin Signals with PoE

Pin	MDI Signal	MDI-X Signal
4	Unused	Unused
5	Unused	Unused
6	RX- and Vport-2	TX- and Vport-2
7	Unused	Unused
8	Unused	Unused

1. Vport-1 can be positive (+) or negative (-), depending on the requirements of the powered device connected to a port.
2. Vport-2 can be positive (+) or negative (-), depending on the requirements of the powered device connected to a port. If Vport-1 is positive, then Vport-2 will be negative. If Vport-1 is negative, then Vport-2 will be positive.

Table 14 lists the RJ-45 pin signals for the two 10/100/1000-Base-T ports on the AT-8550GB switch when the ports are operating at 1000 Mbps.

Table 14. MDI and MDI-X Pin Signals (1000Base-T)

MDI Configuration		MDI-X Configuration	
Pinout	Pair	Pinout	Pair
1	Pair 1 +	1	Pair 2 +
2	Pair 1 -	2	Pair 2 -
3	Pair 2 +	3	Pair 1 +
4	Pair 3 +	4	Pair 4 +
5	Pair 3 -	5	Pair 4 -
6	Pair 2 -	6	Pair 1 -
7	Pair 4 +	7	Pair 3 +
8	Pair 4 -	8	Pair 3 -

## AT-8516F/SC Fiber Optic Port Specifications

---

Standard:	100Base-FX
Speed:	100 Mbps
Maximum Operating Distance:	2 km (1.24 mi)
Connectors:	
AT-8516F/SC	Dual SC Connector
Type of Cabling:	50/125 micron or 62.5/125 micron (core/cladding) multimode fiber optic cabling
Operating Wavelength:	1310 nm
Transmitter Output Power:	
50/125 micron cabling	
Minimum:	-22.5 dBm average
Maximum:	-14 dBm average
62.5/125 micron cabling	
Minimum:	-19 dBm average
Maximum:	-14 dBm average
Receiver Sensitivity:	
Minimum:	-31 dBm average
Maximum:	-14 dBm average

## RS-232 Terminal Port Pinouts

---

Table 15 lists the pin signals on the RS-232 terminal port.

Table 15. RS-232 Terminal Port Pin Signals

<b>Pin</b>	<b>Signal</b>
1	Data Carrier Detect
2	Transmit Data
3	Receive Data
4	Data Set Ready
5	Ground
6	Data Terminal Ready
7	Clear to Send
8	Request to Send
9	Ring Indicator

## RPS Connector Port Pinouts

Figure 30 illustrates the pin layout to the 16-pin molex connector and RPS port on the AT-8516F/SC, AT-8524M, AT-8550GB, and AT-8550SP switches.

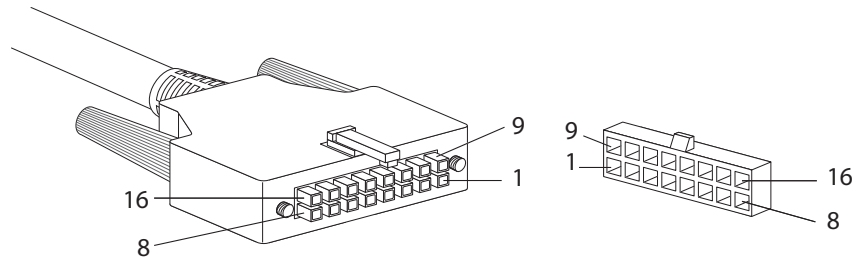

Figure 30. RPS 16-pin Molex Connector Pin Layout

Table 16 lists the 16-pin RPS connector pins and definitions.

Table 16. Pin Definitions of the 16-pin RPS Connector

Pin	Definition
1	+5V DC
2	Remote Sense (RS) +3.3 V DC
3	RS -3.3 V DC
4	RS +2.5V DC
5	Redundant Power Supply (RPS) present
6	+2.5V DC Return
7	+3.3V DC Return
8	+3.3V DC
9	+5V DC Return
10	+2.5V DC
11	+2.5 DC Return
12	+2.5V DC
13	+2.5V DC Return
14	+2.5V DC
15	+3.3V DC

Table 16. Pin Definitions of the 16-pin RPS Connector (Continued)

Pin	Definition
16	+3.3V DC Return

Figure 31 illustrates the pin layout to the RPS connector on the AT-8524POE switch.

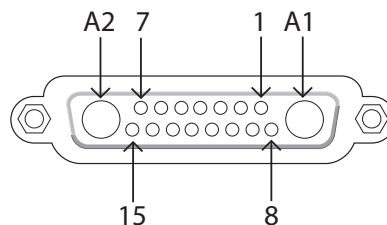

Figure 31. AT-8524POE RPS Connector Pin Layout

Table 17 lists the RPS connector pins and definitions.

Table 17. Pin Definitions for the RPS Connector on the AT-8524POE Switch

Pin	Definition
A1	48V Return
A2	Return
1	48V
2	48V RS+
3	Redundant Power Supply (RPS) present
4	12V RS-
5	12V RS+
6	12V
7	3.3V
8	48V
9	48V
10	48V RS-
11	RPS GOOD
12	3.3V RS-



Table 17. Pin Definitions for the RPS Connector on the AT-8524POE Switch (Continued)

<b>Pin</b>	<b>Definition</b>
13	3.3V RS+
14	3.3V
15	3.3V

## Dual SC Type Connector

---

A dual SC type connector, as shown in Figure 32, is used with the AT-8516F/SC switch.

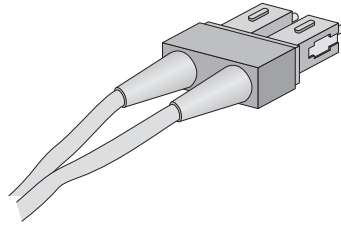

Figure 32. Dual SC Connector