



Index	Safety Precautions	Features	Installing	Device Driver	How to Use	Utilities	Storing/Cleaning	Troubl
-------	--------------------	----------	------------	---------------	------------	-----------	------------------	--------



Samsung's OMS (Optical Media Solution) Customer Support Website (<http://www.samsung-ODD.com>) offers the latest versions of firmware for ODD products, user instructions and product information.

Select Model
SH-S243D(TS-H663D)



The Statement

<http://www.s>

<http://www.s>

Select Model
SH-S243D(TS-H663D)

Select Languages
English

▶ **Main Page**

▶ **Safety Precautions**

- ▶ Safety Precautions
- ▶ During Installing
- ▶ During Operating
- ▶ Others
- ▶ RoHS & WEEE

▶ **Features**

- ▶ Exterior
- ▶ System Requirements
- ▶ Features

▶ **Installing DVD Writer and Connecting Cables**

- ▶ Installing Drive
- ▶ Connecting Cables

▶ **Installing Device Driver and Confirming The Installation**

- ▶ Firmware Update
- ▶ Confirming the Installation of Device Driver

▶ **How To Use The DVD Writer**

- ▶ How to Use the Drive
- ▶ How to Use DVD±R/RW and Other Discs
- ▶ MAGIC SPEED
- ▶ How to use the TruDirect

▶ **Storing/Cleaning Drive and Disc**

- ▶ Cleaning the Drive
- ▶ Storing the Disc
- ▶ Cleaning the Disc
- ▶ When the LED Blinks

▶ **Deleting Utilities**

▶ **Troubleshooting**

- ▶ Troubleshooting
- ▶ Caution: Possible Errors





▶ **Product Specifications**

Select Model
SH-S243D(TS-H663D)

Select Languages
 English

Important to read and understand at all times



 Warning	<p>This symbol indicates explanations about extremely dangerous matters. If users ignore this symbol and handle the device the wrong way, serious injury or death could result.</p>
 Caution	<p>This symbol indicates explanations about dangerous matters. If users ignore this symbol and handle the device the wrong way, damage to home or property could result.</p>
	<p>Important to read and understand at all times.</p>
	<p>Do not disassemble.</p>

<p><input type="checkbox"/></p>	<p>Always make sure that the disc does not have a crack before use. If the disc has a crack (especially around the center hole), it is recommended to make a copy immediately and use the copy instead. When a cracked disc is used continuously, the size of the crack is likely to grow and this will eventually result in irreparable damage to the disc.</p>
---------------------------------	--

Select Model
SH-S243D(TS-H663D)

Select Languages
English

Installing

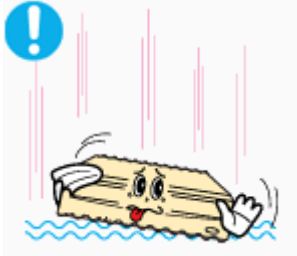

- ❖ Do not drop the drive, and protect it from severe shocks.
 - It can damage the drive or cause it to malfunction.

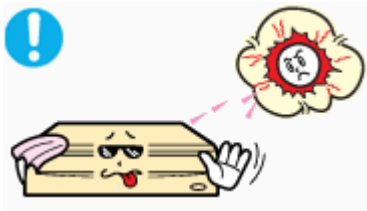

- ❖ Do not place the drive in direct sunlight.

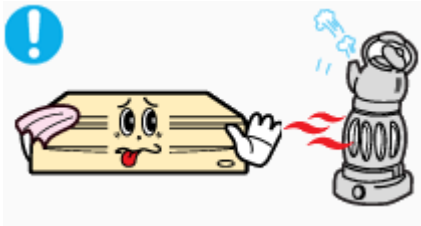

- ❖ Avoid low-or high-temperature environments.

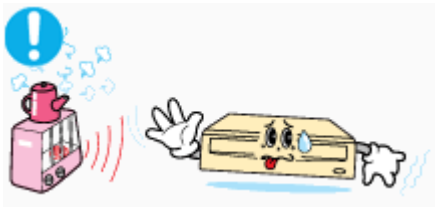

- ❖ Avoid high-humidity environments.

←UP

Select Model
SH-S243D(TS-H663D)

Select Languages
English

Operating

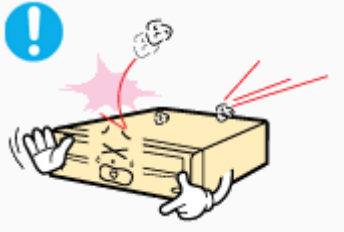

- ❖ Handle with caution to prevent damage from an external shock.

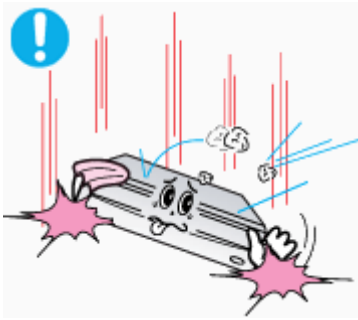

- ❖ Do not drop the drive, and protect it from severe shocks.
 - It can damage the drive or cause it to malfunction.

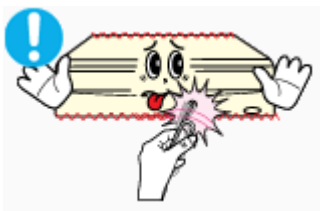

- ❖ Do not move the drive while in operation and do not attempt to open the disc tray by force. Make sure to close all working programs before attempting to open the tray and always use the open/close button.



Do not insert a pin into the emergency opening while in operation.



Do not insert hands in the tray while in operation. This may cause damage to the product or human body.

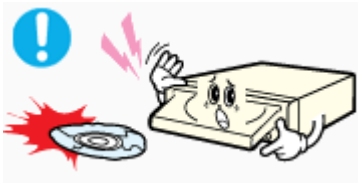

- ❖ Do not use cracked, distorted or damaged discs.



In particular, a disc with a crack on the inner tracks may break while in use.

Always check to be sure the disc is not cracked before use. If you find a crack on the disc (especially around the center hole), make a copy of the disc immediately and use the copy instead. Continued use of a cracked disc will cause the crack to become bigger, resulting in irreparable damage to the disc.

Do not use low-quality discs (illegal, scratched, damaged, etc.).

Samsung is not responsible for any loss resulting from the use of such discs.

▲UP

Select Model
SH-S243D(TS-H663D)

Select Languages
English

Others



- Never allow food particles or foreign substances to enter the drive casing.

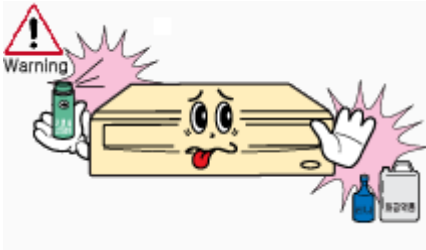

- To protect against the risk of fire, do not spill such liquids as alcohol and benzene on the drive.

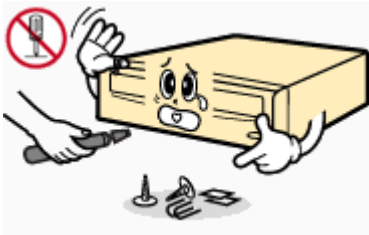

- Do not disassemble, attempt to repair or modify the device without an express approval as directed in the manual.
- To reduce the risk of damage, electric shock and fire.

←UP

Select Model
SH-S243D(TS-H663D)

Select Languages
English

RoHS



Samsung Eco-mark
The Samsung's own Eco mark helps consumers to easily understand that Samsung develops eco-friendly products. This mark represents Samsung's continuous effort to develop eco-friendly products.

RoHS (Restriction of the use of certain hazardous substances in electrical and electronic equipment)The RoHS, the environmental regulation announced by European Union, restricts the use of lead, mercury, cadmium, hexavalent chromium, PBB, and PBDE in products put on the market in The European Union after July 1, 2006.

WEEE

Correct Disposal of This Product (Waste Electrical & Electronic Equipment)

(Applicable in the European Union and other European countries with separate collection systems)



This marking on the product, accessories or literature indicates that the product and its electronic accessories (e.g. charger, headset, USB cable) should not be disposed of with other household waste at the end of their working life. To prevent possible harm to the environment or human health from uncontrolled waste disposal, please separate these items from other types of waste and recycle them responsibly to promote the sustainable reuse of material resources.

Household users should contact either the retailer where they purchased this product, or their local government office, for details of where and how they can take this item for environmentally safe recycling.

Business users should contact their supplier and check the terms and conditions of the purchase contract. This product should not be mixed with other commercial wastes for disposal.



Select Model
SH-S243D(TS-H663D)

Select Languages
English

Front



1. Emergency Hole
3. Eject Button

2. LED
4. Door Tray

- Design and specifications are subject to change without prior notice.

Back

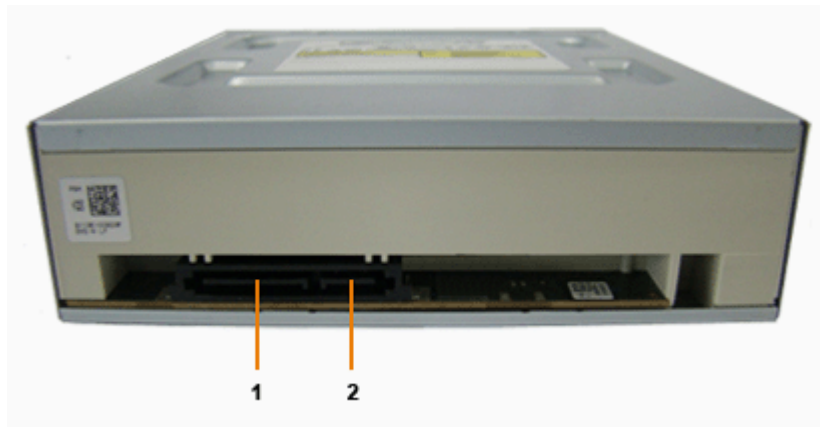

1. S-ATA Power Port

2. S-ATA Data Port

Components

- ▶ DVD Writer
- ▶ S-ATA Data Cable
- ▶ Mounting Screws
- ▶ Quick Installation Guide
- ▶ Application software & User manual CD

- In case you need to return the purchased product, be sure to include all the accessories provided with the product to receive a refund.

- The type of accessories varies depending on a product model.
and some accessories described herein are subject to change without notice.



Select Model
SH-S243D(TS-H663D)

Select Languages
 English

System Requirements

Item	Description
OS	Microsoft Windows 2000/XP/Vista
CPU	S-ATA supported PC (The compatible mainboard list can be found from the website) Pentium4 2.0GHz or above
RAM	512 MB or more (Windows 2000/XP), 1 GB or more (Windows Vista)

Select Model
SH-S243D(TS-H663D)

Select Languages
English

Features

Versatile Multimedia Features

	Disc Type	Writable	Rewritable	Read
DVD	DVD-ROM	x	x	O
	DVD-ROM DL	x	x	O
	DVD±R	O	x	O
	DVD-RW	O	O	O
	DVD+R DL	O	x	O
	DVD-R DL	O	x	O
	DVD+RW	O	O	O
	DVD-RAM	O	O	O
CD	CD-ROM	x	x	O
	CD-R	O	x	O
	CD-RW	O	O	O

Writable : Write once and read a lot of times.

Rewritable : Read and Write data once or more times.

←UP

DVD Recommended Disc Types

▶ DVD-R Media

Taiyo-Yuden, TDK, MKM, Hitachi, Maxell, FujiFilm, RiTEK, CMC

▶ DVD-RW Media

TDK, MKM, JVC, RiTEK, CMC

▶ DVD+R Media

RICOH, Taiyo-Yuden, MKM, RiTEK, CMC, Prodisc, Optdisc

▶ DVD+RW Media

RICOH, MKM, RiTEK, CMC

▶ DVD±R DL

MKM, RICOH

▶ DVD-RAM

Maxell

CD Recommended Disc Types

▶ CD-R Media

Taiyo-Yuden, RICOH, MKM, Hitachi, Maxell, FujiFilm, RiTEK(Phtharo), CMC, Pioneer, Princo, TDK

▶ CD-RW Media

RICOH, MKM, RiTEK, CMC

▶ **HS CD-RW Media**
RICOH, MKM, CMC

▶ **US CD-RW Media**
MKM

● **Buffer underrun prevention technology included**

▶ What is "buffer underrun prevention technology"?

A technology to prevent "**buffer underrun**" errors in which the data transmission speed is not as fast as the data writing speed when data is being recorded on a disc.

● **Reading / Writing Speed**

▶ Reading Speed(MAX)

DVD-ROM(16X), DVD-ROM DL(12X), DVD-R(16X), DVD-RW(12X), DVD+R(16X), DVD+RW(12X), CD-ROM(48X), CD-R(40X), CD-RW(40X), DVD+R DL(12X), DVD-R DL(12X), DVD-RAM(12X)

▶ Writing Speed(MAX)

DVD+R DL(16X), DVD+RW(8X), DVD-R(24X), DVD+R(24X), DVD-RW(6X), CD-R(48X), CD-RW(32X), DVD-R DL(12X), DVD-RAM(12X)

(The maximum speed depends on the writing media condition or some of user PC environment.)



Select Model
SH-S243D(TS-H663D)

Select Languages
English

Installing Drive

1. Turn the PC off.
2. Open the cover as shown in the picture.

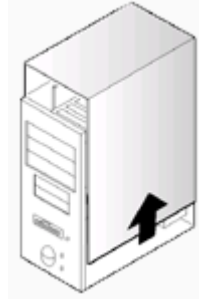

3. If necessary, attach the support devices on both sides of the drive
 - The support devices are PC accessories. Purchase a pair if necessary.
(SCREW : M3 X 6 X 4)

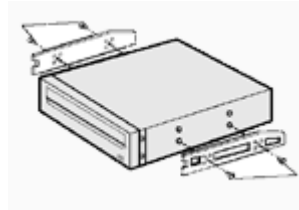

4. Insert the DVD Writer after removing the plate as below.
 - Be sure to use the screws (M3x6) provided with the product.
 - Using screws other than M3x6 may cause malfunction.



Be sure that the screws are tightened securely in place.
Loosely tightened screws may result in an increased level of noise.



▲UP

Select Model
SH-S243D(TS-H663D)

Select Languages
English

Connecting Cables

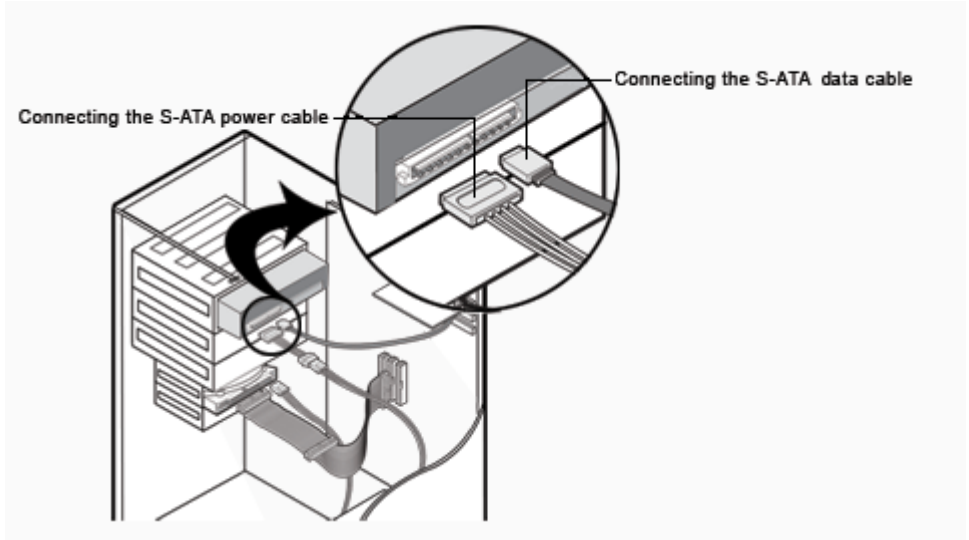

Connecting S-ATA Cable

When you use one S-ATA cable

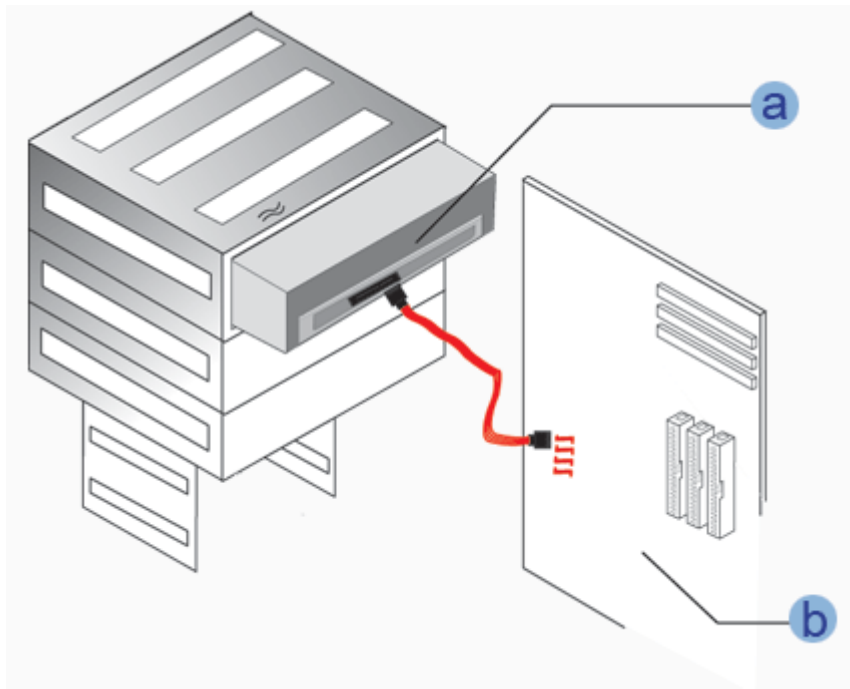

a : Drive
b : Mainboard

◀ UP

▶ When you have one DVD Writer and the other ODD products.

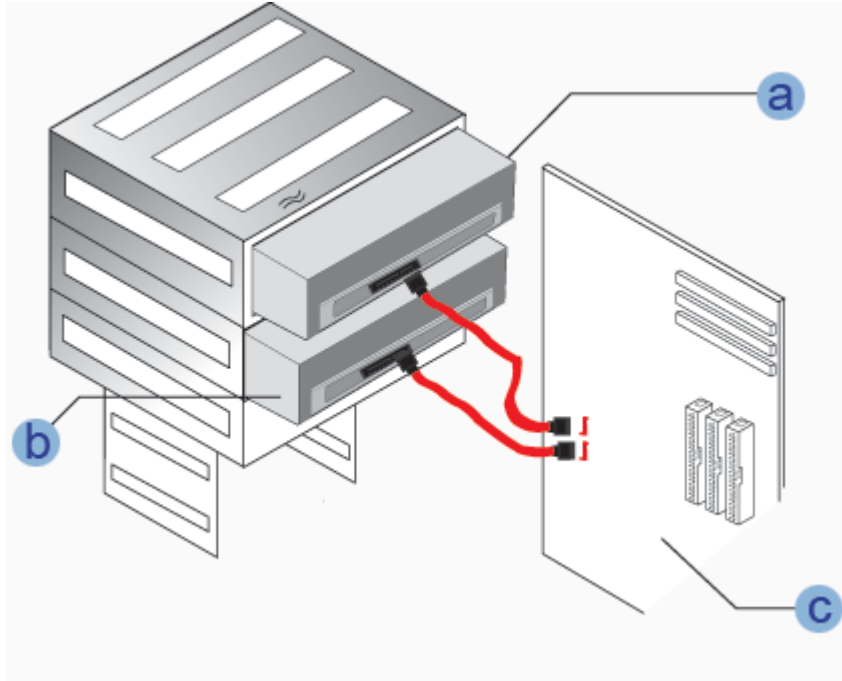

- a : Drive (S-ATA 1)
- b : Drive (S-ATA 2)
- c : Mainboard

◀ UP

Select Model
SH-S243D(TS-H663D)

Select Languages
English

Firmware Update

1. Go to www.samsung-ODD.com
2. Click Firmware on the menu bar (in the upper right-hand corner).
3. Click Firmware Downloads. Check for your drive model and start downloading.

Select Model
SH-S243D(TS-H663D)

Select Languages
English

Confirming the Installation of Device Driver

Confirming Using [Device Manager]

Windows 2000

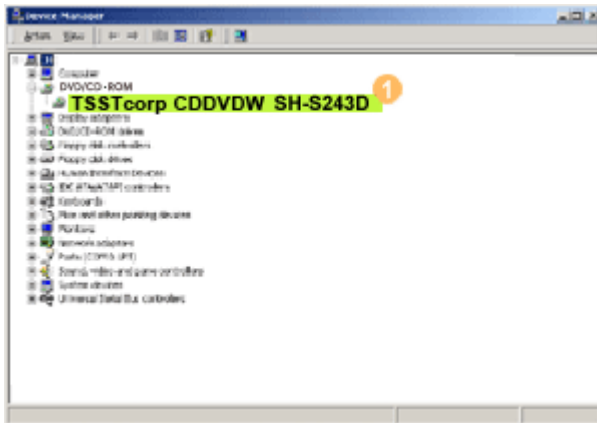

1. Click [Start] - [Settings] - [Control Panel] - [System]
2. Click on the [Hardware] tab in the System Properties window and then click on the [Device Manager] tab.
3. Click DVD-W drive in the Device Manager window.

① in the left picture appears if the driver is installed properly.

Windows XP

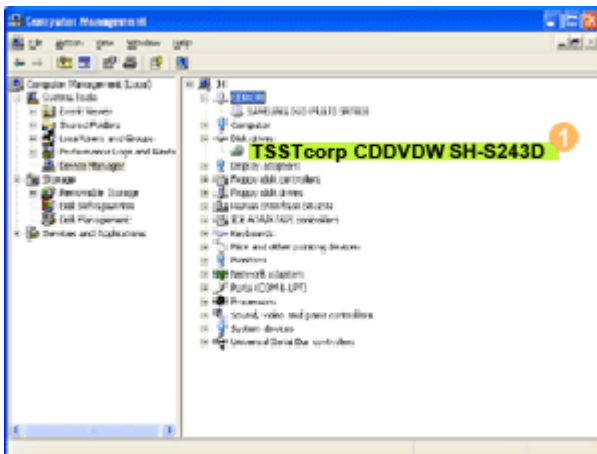

1. Go to [Start] - [Settings] - [Control Panel] - [Performance and Maintenance]
2. Click [Administrative Tools] icon in the Performance and Maintenance window.
3. Click [Computer Management] icon in the Administrative Tools window.
4. Click [Device Manager] icon in the Administrative Tools window and then click DVD-W drive.

① in the left picture appears if the driver is installed properly.

Windows Vista

1. Click [Start] - [Control Panel] - [System] - [Device Manager].
2. Click DVD-W drive in the Device Manager window.

① in the left picture appears if the driver is installed properly.

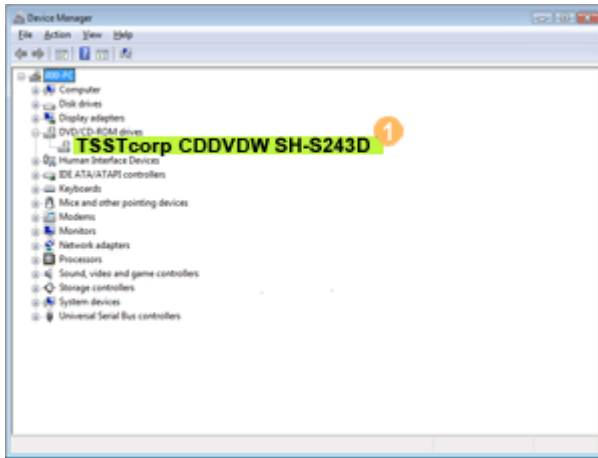

← UP

Select Model
SH-S243D(TS-H663D)

Select Languages
English

How to Use the Drive

While the LED indicator is blinking green, do not turn the PC off, nor disconnect the DVD Writer. Otherwise it may cause damage to the drive.

How to Use a Horizontally Installed Drive

You can use **3.15 Inch or 4.72 Inch (8cm or 12cm) disc.**

The drive cannot read the disc properly if any part of the disc is placed outside the tray guiding line.

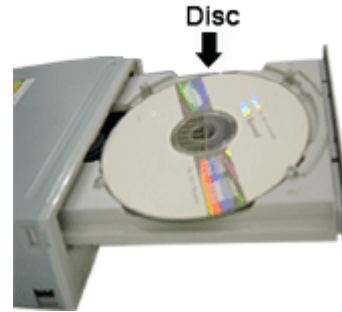

← UP

How to Use a Vertically Installed Drive

This drive can be installed vertically.

You can use only the **4.72 Inch (12cm) disc.**
(You cannot use the 3.15 Inch (8cm) disc)

The drive cannot read the disc properly if any part of the disc is placed outside the tray guiding line.



← UP

Select Model
SH-S243D(TS-H663D)

Select Languages
English

How to Use DVD±R/RW and Other Discs



The DVD Writer allows writing DVD±RW discs using Nero Express and enables "packet writing" (high-speed recording) using InCD. The drive also allows writing DVD±R discs using Nero Express.



Caution

Unauthorized copying of DVD or software titles is illegal and the individuals that make illegal copies will be held responsible for any copyright infringement. Using low-quality discs may lengthen the recording time or not supporting due to reduction in double speed.

- ▶ You can use the DVD Writer to playback Music CD, CD-ROM, CD-R/RW, or DVD-ROM disc like a CD-ROM drive or a DVD-ROM drive. If your computer recognizes the [CD-ROM] icon designated to the DVD Writer as the 'E:' drive, insert a CD-ROM or a DVD-ROM disc and access the 'E:' drive.

(The actual drive letter of the DVD Writer may vary depending on the user's system environment.)

- ▶ If you want to use this product to play a commercial DVD-Video title('DVD title')
 - Most of DVD titles in the market adopt the Dolby sound system. You are required to install software that supports Dolby decoding on your PC before you can play a DVD title using the DVD writer purchased.
 - How to obtain commercial software supporting Dolby decoding. Visit the website of Nero: <http://www.nero.com> (You can use other compliant software if you want to.)

DVD Region Protection Coding (RPC):

The RPC feature is supported on DVD players and is used with DVD-video discs (such as movies). Currently, the motion picture industry has divided the world into different regions or zones that correspond to the regional markets into which the motion picture industry releases movies. Simply put, RPC codes are placed on movies marketed throughout the world, based on the region of the world in which they are being sold. These RPC codes help control and prevent pirating of new movies into other motion picture regions prior to their true release dates within those markets.

The DVD Writer supports RPC phase II. In the RPC-2 mode, the local code can be changed by users. RPC-2 is selected by default for The DVD Writer.

You can change the region code up to five times via an MPEG application.

Please contact your dealer or local SAMSUNG representative if you wish to change the local code more than five times.



Select Model
SH-S243D(TS-H663D)

Select Languages
English

▶ What is MAGIC SPEED?

MAGIC SPEED is a program that supports user to select at his or her discretion the reading speed of CD disc between two modes offered by drive: Maximum Speed Mode (Max Mode) and Silent Mode.

▶ Development Background

ODD products launched nowadays are providing a high reading speed. With the increased reading speed, faster data processing has become possible. However, high rotation speed often causes louder noise, and it is more possible to crash the cracked or bent discs. Against this backdrop, our Company has developed a speed-down algorithm and applied this technology to newly-launched products to provide safer and more comfortable environments for PC users.

※ What is Speed-down Algorithm?

It establishes a safer disc reading speed in operating the device in order to prevent possible disc crashes in using CDs with cracks in starting. In addition, for customers who want to play CDs at its maximum speed, MAGIC SPEED program offers the function of selecting reading speed, so that customers can set the speed as they want. (Recording speed will run at recordable speed without limit)

▶ What are MAGIC SPEED and How to Use?

MAGIC SPEED Mode

- Max Mode: Setting reading speed to its maximum level provided by drive.
- Silent Mode: Setting reading speed to a stable low speed.
- Any mode set by Magic Speed will be reset to "Low noise mode" when the PC restarts, so please check the current mode if you want to use "The maximum speed mode" and change the settings where necessary.

Caution: A disc with crack may be crashed in playing with Max Mode. We recommend you to use such disc in Silent Mode, or make a copy immediately before use.

How to Use MAGIC SPEED

- First, install MAGIC SPEED program registered on our website.
- On MAGIC SPEED tray icon, select right-click to execute the program.
- Select the mode you want to use on Program Execution Window and select "settings". Then, reading speed of the drive will run in selected mode.
- Select "Close" to exit Program Execution Window.
In this occasion, reading speed will be run in the set speed if there is no separate mode change or program exit.
- ※ We recommend you to use "Max Mode" for data copy or disc copy, and "Silent Mode" for normal operation.
- ※ Other functions
 - ▶ To disable Auto Run
This is a default program that automatically runs in every PC booting.
If you want to quit this auto run function, deselect the auto run item selected on tray icon menu.

Where Can I Download MAGIC SPEED?

Visit our website for customer support (URL:www.samsung-ODD.com), and select Firmware → MAGIC SPEED.



Select Model
SH-S243D(TS-H663D)

Select Languages
English

How to use the TruDirect

1. Connect the Video/Audio devices to your computer before you start TruDirect.

Camcorder, Digital Camera, Webcam Manual.



2. Click the TruDirect Program Shortcut on your Desktop of Windows.



3. Make the DVD title from Live Video, Photo Files, Video Files.

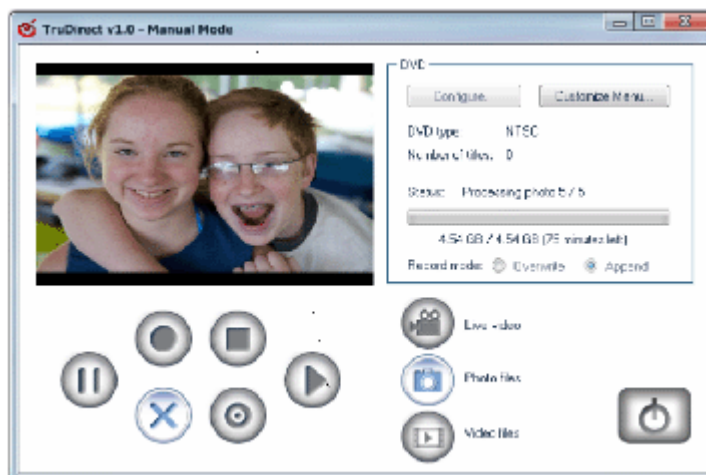

4. Play DVDs made with TruDirect on your DVD player or PC.



Select Model
SH-S243D(TS-H663D)

Select Languages
English



Click [Start] - [Setting] - [Control Panel] - [Add/Remove Programs] and a window as shown below appears.

[Windows 2000]



Click the [Add/Remove] button to remove the program.



[Windows XP]

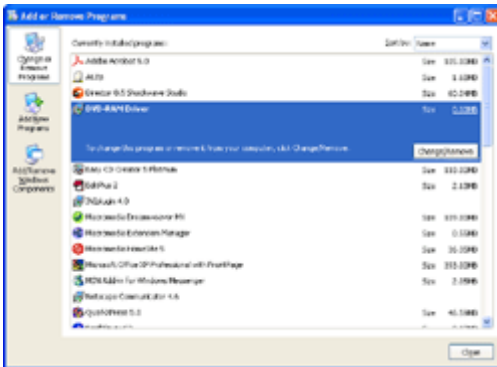

Click the [Add/Remove] button to remove the program.



[Windows Vista]

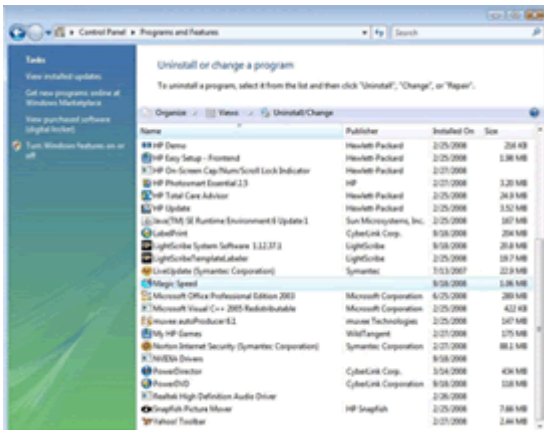

Click the [Add/Remove] button to remove the program.

Select Model
SH-S243D(TS-H663D)

Select Languages
English

Cleaning the Drive

- Turn the PC off and pull out the drive.
- Remove any foreign objects from the surface of the drive using soft cloth.



- Do not use benzene, paint thinner, or any other solvents.
- Cleaning the interior of the unit with such things as a cotton swab may cause a failure or a loss of function.

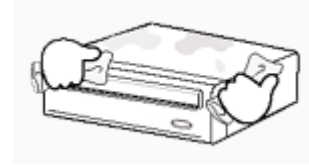

Select Model
SH-S243D(TS-H663D)

Select Languages
 English



**This part of the manual is to prevent damages or data loss.
Read carefully and use the device properly.**

Storing the Disc

- ▶ Do not place it under the direct sunlight.
- ▶ Place it so that it sits on its side on a flat surface.
- ▶ Do not scratch or place a label on the disc.
- ▶ Handle the disc with caution to prevent damage from an external shock.
- ▶ Do not expose it to severe temperature-fluctuations.
(Exposure to such environment may cause congealing.)



Select Model
SH-S243D(TS-H663D)

Select Languages
English



**This part of the manual is to prevent damages or data loss.
Read carefully and use the device properly.**

Cleaning the Disc

- Do not touch the surface of the disc.
Place your fingers on the edge of the disc to hold.
- Clean the disc lightly with soft cotton cloth, starting from the center and move to the edge of the disc.
- Use only disc-cleaning liquids. Do not use benzene, paint thinner, or any other solvents.



If the disc surface becomes dirty with fingerprints, foreign substances or dust, the disc may not function properly.

← UP

Select Model
SH-S243D(TS-H663D)

Select Languages
English

When the LED blinks

LED	Meaning
Disc Lead-In	Green: Blinks every 0.3 seconds.
Writing	Green: Blinks every 0.3 seconds.
Reading	Green: Blinks every 0.3 seconds.
Standby	Off
No Disc	Off



The indicator light turns off when the drive is not in use (standby) after disc lead-in.

Select Model
SH-S243D(TS-H663D)

Select Languages
English

General Problems

Problem	Meaning / Solution
The tray doesn't open.	See if the PC is on. Make sure the power cable within the PC is connected properly. If the tray still won't open with the power-on, turn the power-off and insert a pin(paper clip) into the emergency hole to open.
The tray doesn't close.	Make sure the disc has been inserted properly.
The PC is not working properly.	See if the drive is properly connected to the PC.
The drive is not working properly.	See if the drive is connected properly to the PC. See if the device drive program has been installed properly.
The system dosen't read the disc.	See if the system detects the drive. Make sure you use the types of discs that are supported by the drive. Check if the LED indicator turns green. Make sure you inserted the disc with the label facing up. Make sure you are using the right program for disc playback. See if the disc is clean. See if any congealing has occurred. Make sure the region code of the drive matches the disc number.

You can confirm the use of software at the site of our customer support.

Address: www.samsung-ODD.com

- See " SUPPORT > Download Center > User Manual "
- See " INFORMATION > Flash Manual > Recording Software "
- See " INFORMATION > Flash Manual > Software Quick Manual "



Select Model
SH-S243D(TS-H663D)

Select Languages
English

Caution: Possible Errors

DVD Writer records data on the disc by applying laser light onto the surface of the disc, and therefore writing errors may occur if you use a damaged disc, for example. Be sure to eliminate the following error-causing elements before you start writing.

* The following settings are recommended for all DVD Writer.

- 1. Avoid a situation that requires multitasking, and remove turn off the screen saver.**
 - A buffer underrun may occur if the system multitasks while the DVD Writer is writing/erasing.
- 2. Block any outside attempt to access the host PC during a writing session.**
 - An error may occur if another user accesses the printer connected to his/her the system via the network during a writing session.
- 3. Disable the CD auto-run feature of the CD.**
 - Inserting an auto-run enabled CD in to another drive connected to the same system during a writing/erasing session may cause an error.
- 4. It is recommended that you use the image file format when you write a large number of small-sized files.**
 - When there are a large number of small-sized files to write, the system's transfer rate drops and the Superlink feature works at a more frequent rate, resulting in lower writing quality.
 - If you are doing a CD-to-CD write, it is not necessary to check to see if you have available space on your hard disc beforehand.

However, in the case of image files, it is recommended that you be sure you have at least twice the amount of space needed for the data on your hard disc, as image files are copied to the hard disc before they are copied to the media.

- 5. Use a regulation-length (50cm) or shorter S-ATA cable.**
 - Using an S-ATA cable longer than 50cm may cause a transmission error.
- 6. Do not use more than one type of writing software.**
 - Before you install a writing program, be sure to first uninstall existing versions of the program or other writing program(s) and reboot the system first.

(The Windows operating system may be damaged if you install the Korean version while the English version remains on the system.)

- **It is recommended to use the data recording software provided by Samsung. You may experience an error if you use other recording software.**

The write speed for a disc can be restricted if

- 1. ■ The disc has bad properties data, and or there are other discs with different properties available under the same ID.**

The drive's write strategy is set in a way that the drive examines to examine the disc properties and determines the optimal write conditions for those properties.

For example, many disc makers do not bother to insert property information distinguishing 48X discs from 32X discs. Since the two types of discs have the same properties data, although they actually have different properties, it is often impossible to respond to the situation with a single write strategy. In order to ensure stable writing, it is necessary to downgrade the write speed.

If discs from two different disc makers have the same write speed according to the labels, but actually have different write speeds, it is necessary to downgrade the write speed to ensure stable writing.

- 2. ■ Samsung's Standards for Write Speed Restriction.**

Standard 1 Write speed is downgraded for the sake of write stability, if high-speed discs available in the market have particularly bad properties data, or there are low-speed discs available under the same ID.

Speed-restricted discs go through further examination and adjustments

Standard 2 later. If high-speed discs are available under the same ID with as low-speed discs (speed restricted at present), the speed restriction is removed when the low-speed counterparts become no longer unavailable in the market under the same ID.



You may experience lower write quality in case if you use disc products by some disc makers which that are not registered with the product's firmware. Therefore, it is recommended that you use only discs by recommended companies. Even, and even if the write session is completed successfully, check the write quality before you put the disc in storage, especially in case of an important data backup. (Samsung is not responsible for any loss resulting from data backup failure.)



We update the list of supported media on a regular basis through our firmware upgrades.



Select Model
SH-S243D(TS-H663D)

Select Languages
English

Category		SH-S243D(TS-H663D)			
		DVD Writer			
DISC	Usable Discs	DVD :DVD-R, DVD-RW, DVD+R, DVD+RW, DVD-ROM, DVD-Video, DVD+R DL, DVD-R DL, DVD-RAM			
		CD : CD-ROM, CD-R, CD-RW, CD-DA, CD+E(G) CD-MIDI, CD-TEXT, CD-ROM XA, Mixed Mode CD, CD-I, CD-I Bridge (Photo-CD, Video-CD), Multisession CD (Photo-CD, CD-EXTRA, Portforio)			
Interface Support	Disc Diameter	4.72 Inch or 3.15 Inch (120mm or 80mm)			
	Interface Port	S-ATA			
	Burst Transfer Rate	S-ATA 1.5Gbps			
ACCESS TIME (Random)	CD-ROM	110ms			
	DVD-ROM	130ms			
Data Transfer Speed (Max)	Media Type	Write	TruDirect Write	Read	
	DVD+R	CAV 24X	CLV 4X	CAV 16X	
	DVD+RW	ZCLV 8X	ZCLV 8X	CAV 12X	
	DVD+R DL	CAV 16X	CLV 4X	CAV 12X	
	DVD-R DL	CAV 12X	CLV 4X	CAV 12X	
	DVD-R	CAV 24X	CLV 4X	CAV 16X	
	DVD-RW	CLV 6X	CLV 6X	CAV 12X	
	DVD-ROM	-		CAV 16X	
	DVD-ROM DL	-		CAV 12X	
	DVD-RAM	PCAV 12X	CLV 12X	PCAV 12X	
	CD-ROM	-		CAV 48X	
	CD-R	PCAV 48X		CAV 40X	
	US-RW	ZCLV 32X		CAV 40X	
	HS-RW	CLV 10X		CAV 40X	
CD-RW	CLV 4X		CAV 40X		
Buffer Memory	2MB				
Drive Installation	Horizontal / Vertical				
Operating Environment	Temperature	41°F ~ 122°F (5°C ~ 50 °C)			
	Humidity	20% ~ 80% (RH)			
Dimension(Width x Height x Length)	5.34 X1.65 X 6.69 Inch (148.2 X 42 X 170mm)				
Weight	750g				



Note

- ▶ Do not support DVD-R for Authoring.
- ▶ Cannot playback or record on both sides of a dual layer disc simultaneously.
- ▶ The read/write capacity of the supported discs depends on the condition of the disc and the recording format of the drive. Therefore, the read/write quality may not be perfect.
- ▶ Please firmly place the product onto the PC before use.
- ▶ Specifications are subject to change without notice.



FCC information to the user

This equipment has been tested and found to comply with the limits for a Class B digital device, pursuant to Part 15 of the FCC Rules. These limits are designed to provide reasonable protection against harmful interference in a residential installation.

This equipment generates, uses and can radiate radio frequency energy and, if not installed and used in accordance with the instructions, may cause harmful interference to radio communications.

However, there is no guarantee that interference will not occur in a particular installation.

If this equipment does cause harmful interference to radio or television reception, which can be determined by turning the equipment off and on, the user is encouraged to try to correct the interference by one or more of the following measures:

- ▶ Reorient or relocate the receiving antenna.
- ▶ Increase the separation between the equipment and receiver.
- ▶ Connect the equipment into an outlet on a circuit different from that to which the receiver is connected.
- ▶ Consult the dealer or an experienced radio/TV technician for help.

CAUTION

Change or modifications not expressly approved by the manufacturer responsible for compliance could void the user's authority to operate the equipment.

**Laser Standard**

IEC 60825-1 : 1993 + A1 : 1997 + A2 : 2001



The product specifications above may be changed to improve device performance without prior notice.

