

ENGLISH

# **PHILIPS CD-ROM Drive**

**User's Manual**

**PCA82CR  
PCA102CD**

---

# Table of Contents

<b>Chapter 1</b>	<b>INTRODUCTION</b>	<b>1</b>
1.1	Features	1
1.2	Package Contents	2
1.3	System Requirements	2
<b>Chapter 2</b>	<b>PRECAUTIONS</b>	<b>3</b>
2.1	During Installation	3
2.2	During Operation	3
2.3	During Transport	4
2.4	When Handling a Disc	4
2.5	Servicing the Drive	4
<b>Chapter 3</b>	<b>INSTALLING YOUR DRIVE</b>	<b>5</b>
3.1	Installing the CD-ROM Drive	5
3.2	Letting Your System Recognize the Drive	8
3.2.1	If You Are a DOS or Windows 3.1 User	8
3.2.2	If You Are a Windows 95 User	10
3.2.3	If You Are an OS/2 Warp User	13
<b>Chapter 4</b>	<b>USING YOUR CD-ROM DRIVE</b>	<b>17</b>
4.1	Drive Applications	17
4.2	Front Panel Controls	17
<b>Appendix A</b>	<b>A MASTER OR A SLAVE DEVICE?</b>	<b>19</b>
A.1	IDE Connections	19
A.2	Setting Master and Slave Jumpers	22
<b>Appendix B</b>	<b>SPECIFICATIONS</b>	<b>23</b>









**Notice 3:**

This product complies with the requirements set out in the Council Directive on the Approximation of the Laws of the Member States relating Electromagnetic Compatibility (89/336/EEC). For the evaluation regarding the electromagnetic compatibility, the following standards were applied:

EN 50 082-1, IEC 801-2, IEC 801-3, IEC 801-4  
EN 50 081-1, EN 55 022

---

## **CDC Regulatory Statement (Canada)**

This digital apparatus does not exceed Class B limits for radio noise emissions from digital apparatus set out in the Radio Interference Regulations of the Canadian Department of Communications.

Le présent appareil numérique n'émet pas de bruits radio-électriques dépassant les limites applicables aux appareils numériques de la classe B prescrites dans le Règlement sur le brouillage radioélectrique édicté par le ministère des Communications du Canada.

---

## **D.N.S.F1. Regulatory Statement**

Class 1 laser product

(EN 60825: 1991)

or

Luokan 1 laserlaite



Klass 1 laser apparat

(EN 60825: 1991)

Additional remarks:

VAROITUS - Laitteen käyttäminen muulla kuin tässä käyttöohjeessa mainitulla tavalla saattaa altistaa käyttäjän turyallisuusluokan 1 ylittävälle näkymättömälle lasersäteilylle.

Varning - Om apparaten används på annat sätt än i denna bruksanvisning specificerats, kan användaren utsättas för osynlig laserstrålning, som överskrider gränsen för laserklass 1.

According to EN 60825 sub-clause 6, regarding actions to be taken against dangerous radiation including copies of all warning labels and information about the laser components and radiation data such as wavelength, output power and pluse times.



---

## **Important Safety Notice**

1. Follow all warnings and instructions marked on the product.
2. Danger: Invisible laser radiation when open. Avoid direct exposure to beam.
3. Unplug this product from the wall outlet before cleaning. Do not use liquid cleaners or aerosol cleaners. Use a damp cloth for cleaning.
4. Slots and openings in the cabinet and the back or bottom are provided for ventilation. To protect it from overheating, these openings must not be blocked or covered. This product should never be placed near or over a radiator or heat register, or in a built-in installation unless proper ventilation is provided.
5. This product should be operated from the type of power indicated on the marking label. If you are not sure of the type of power available, consult your dealer or local power company.
6. Never push objects of any kind into this product through cabinet slots as they may touch dangerous voltage points or short cut parts that could result in a fire or electric shock. Never spill liquid of any kind on the product.

---

## **Belangrijke veiligheidsvoorschriften**

1. Let op alle waarschuwingen en instructies die op het product staan vermeld.









1. Befolgen Sie alle auf dem Produkt vorhandenen Warnungen und Anweisungen.
2. Gefahr: Im geöffneten Zustand kann unsichtbare Laserstrahlung entweichen. Vermeiden Sie den direkten Kontakt mit Laserstrahlen.
3. Ziehen Sie den Netzstecker Ihres PC aus der Steckdose, bevor Sie dieses Produkt reinigen. Verwenden Sie keine flüssigen Reinigungsmittel oder Reinigungssprays. Reinigen Sie das Produkt, falls notwendig, mit einem feuchten Tuch.
4. Die Schlitze und Öffnungen am Gehäuse des Produktes dienen zur Lüftung. Um das Produkt vor Überhitzung zu schützen, dürfen die Schlitze und Öffnungen nicht blockiert oder verdeckt werden. Zusätzlich sollten Sie dieses Produkt niemals in der Nähe einer Heizquelle stellen oder in eine Anlage integrieren, außer wenn ausreichende Lüftung gewährleistet ist.
5. Dieses Produkt sollte mit der auf dem Etikett angegebenen Netzspannung betrieben werden. Fragen Sie Ihren Händler oder Ihr lokales Stromversorgungsunternehmen, welche Netzspannung verfügbar ist.
6. Stecken Sie niemals Gegenstände durch die Schlitze und Öffnungen in das Produkt, da diese Gegenstände unter gefährlicher Spannung stehende Bereiche berühren oder Teile kurzschließen und somit Brand oder elektrischen Schlag verursachen können. Verschütten Sie keine Flüssigkeiten auf dem Produkt.



---

## Precauzioni Importanti

1. Seguire tutte le istruzioni e precauzioni indicate sul prodotto.
2. Pericolo! Quando l'unità è aperta, c'è una radiazione laser invisibile. Evitare l'esposizione ai raggi laser.
3. Disinserire la spina del PC dalla presa di corrente prima di effettuare operazioni di pulizia sul prodotto. Quando lo si vuole pulire, non bisogna impiegare detergenti liquidi né spray, ma soltanto un panno umido.
4. Le fessure e aperture presenti sull'unità permettono la ventilazione necessaria a proteggerla da surriscaldamento; pertanto queste non devono essere bloccate né coperte. Inoltre, questo prodotto non dovrebbe essere mai posto vicino o sopra termosifoni o altre fonti di calore e neppure incorporato in altri contenitori a meno che non si provveda ad una opportuna ventilazione.
5. Questo prodotto dovrebbe esser fatto funzionare con l'alimentazione elettrica indicata sull'etichetta. Consultare il proprio rivenditore o la società elettrica locale per conoscere i tipi di alimentazione disponibili.
6. Mai introdurre o spingere oggetti di qualsiasi tipo attraverso le fessure e le aperture poiché potrebbero entrare in contatto con zone a voltaggio pericoloso oppure con parti di circuito che possono provocare incendi o scosse elettriche. Non rovesciare mai liquidi di alcun tipo sul prodotto.





# INTRODUCTION

# 1

Congratulations! You have just made a very important upgrade for your PC. By installing the PHILIPS 8X or 10X CD-ROM drive into your IBM PC/compatible, you can now take advantage of the vast host of multimedia software available today at a higher performance than ever. Whether you are interested in the Encyclopedia Britannica, educational games, using your computer as a digital music studio or composing a business presentation with sound, graphics and animation, your new CD-ROM drive will be the tool to efficiently and effectively get all that information into your computer.

## 1.1 Features

This CD-ROM drive has the following key features:

- ✚ IDE/ATAPI interface
- ✚ Access time at 145 ms for PCA102CD and 155 ms for PCA82CR
- ✚ Data transfer rate at 1,500 KB/sec for PCA102CD and 1,200 KB/sec for PCA82CR
- ✚ Built in 128 KB buffer
- ✚ Motorized tray for loading and unloading CDs
- ✚ Standard size: fits into a standard 5.25 inch half-height PC disk drive bay
- ✚ Emergency eject for manual disc ejection
- ✚ Automatic power-saving feature
- ✚ Compatibility with the following disc formats: Audio-CD, Video-CD, CD-ROM/XA, CD-i/FMV (CD-i movies), Karaoke-CD, CD Plus and Photo-CD (both single and multi-session)

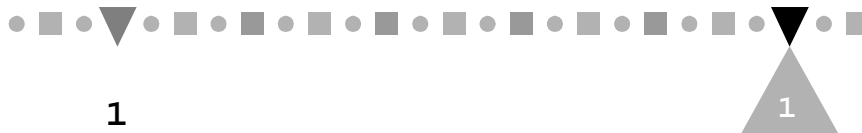

- ✚ Front-panel Stop/Eject, audio Play/Skip track control
- ✚ Compatibility with Windows 3.1, Windows 95 and OS/2

**Note:** *The use of the IDE/ATAPI interface means that you can use your PC's existing IDE interface to set up the drive without the need for an additional CD-ROM interface card.*

## 1.2 Package Contents

Your complete CD-ROM package contains the following items:

- ✚ CD-ROM drive
- ✚ Audio cable
- ✚ IDE cable
- ✚ software diskette
- ✚ Four screws
- ✚ This user's manual

## 1.3 System Requirements

- ✚ IBM PC or compatible, with 80286 CPU or higher (a 80386 or higher is recommended)
- ✚ 3.5" floppy drive
- ✚ One empty 5.25" *horizontally* oriented disk bay
- ✚ One free IDE interface connector
- ✚ MS-DOS 6.0 or later, Windows 3.1 or higher, or OS/2 Warp 3.0 or above



---

Please read this manual thoroughly before installing  
or using your new CD-ROM drive.





# 2

## PRECAUTIONS

### 2.1 During Installation

#### ALWAYS

- ✚ install and use the drive in a *horizontal* position

#### PROTECT THE DRIVE FROM:

- ✚ high temperature, high humidity, extreme temperature changes
- ✚ dusty area
- ✚ excessive vibration
- ✚ direct sunlight
- ✚ inclined places

### 2.2 During Operation

#### ALWAYS

- ✚ keep the tray closed to prevent dust and dirt contamination when not using the drive.
- ✚ turn off your PC power before pressing a thin bar to manually eject the disc tray (see *Chapter 4*)
- ✚ use a voltage regulator or Uninterrupted Power System (UPS) in areas where the power supply voltage varies a lot

#### NEVER

- ✚ move the drive while it is operating
- ✚ operate the drive right after a sudden increase in temperature
- ✚ force the disc tray to open or close by pulling or pushing it



- ⤵ repeatedly open and close the disc tray for no obvious reasons
- ⤵ insert any foreign objects into the disc tray
- ⤵ press hard on the disc tray when it is opened
- ⤵ expose your PC to random electrical noise

## 2.3 During Transport

### ALWAYS

- ⤵ remove any disc from the drive before the transport
- ⤵ pack the drive in the original packing materials

## 2.4 When Handling a Disc

### ALWAYS

- ⤵ store a disc in its case to prevent dust contamination, scratches, bending, and other damage
- ⤵ use a clean, soft and dry cloth to remove dust or fingerprints. Never use fluids like benzene or anti-static fluids to clean a disc
- ⤵ handle a disc by its edges

### NEVER

- ⤵ touch the surface of the disc
- ⤵ write on a disc or place a label on the surface of the disc
- ⤵ bend a disc
- ⤵ place or store a disc in places with high temperature and humidity or under direct sunlight



---

## 2.5 Servicing the Drive

### ALWAYS

- ↘ ask an authorized service technician to perform any service operations

### NEVER

- ↘ attempt to open or remove the drive casing by yourself

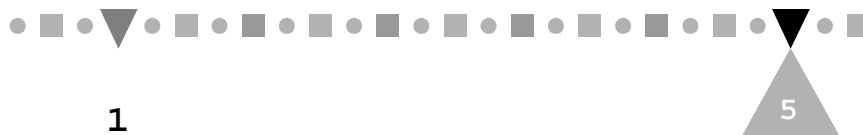

# INSTALLING YOUR DRIVE

# 3

This chapter contains detailed instructions to guide you through the installation of your new CD-ROM drive.

To install the drive, your PC must have at least one free IDE interface connector. If not, you need to go to a computer retailer and buy an IDE controller card (an Enhanced IDE controller card is needed if your PC already has a one-port IDE controller). See *Appendix A* for a brief introduction to IDE connections.

## 3.1 Installing the CD-ROM Drive

Here's how to install your CD-ROM drive:

1. Adjust the Master/Slave jumpers on the back of the CD-ROM drive as necessary. (The factory setting of the slave mode meets most people's needs and normally does not need to be changed. See *Appendix A*.)
2. Disconnect the power to your PC and remove your PC's casing.
3. Slide the CD-ROM drive into the mounting rails of a 5.25" drive bay.

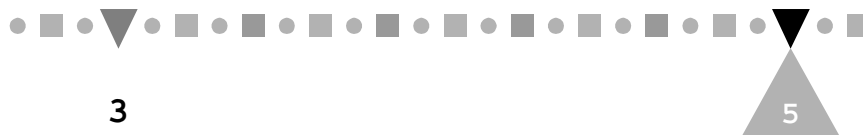

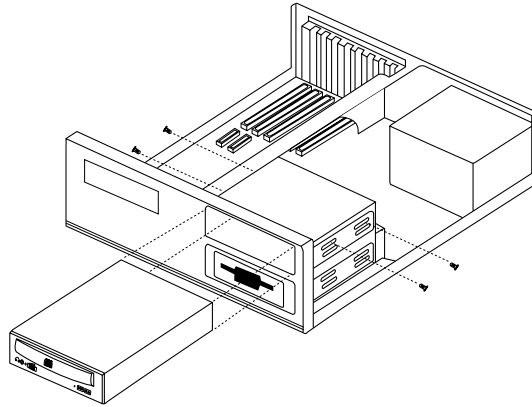

**Figure 3-1**     **Inserting the CD-ROM Drive**

4. Search inside your PC for a free power cable connector and plug it into the 4-pin DC INPUT connector on the back of your CD-ROM drive.
5. Find an IDE cable that has a free connector and plug the connector into the IDE INTERFACE connector on the back of the drive. The cable's colored edge must be aligned with the Pin 1 position.



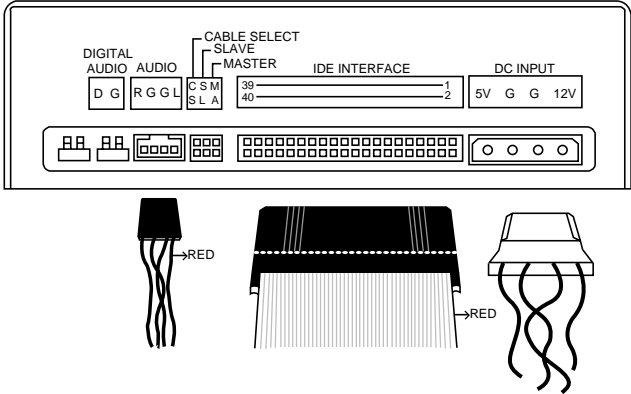

Figure 3-2 Back Panel Connections

**Note:** *If you have a sound card, you can connect either the sound card's IDE cable (if there is one) or one of your PC's available IDE cables to this IDE INTERFACE connector. You must then disable the unused interface port in the sound card's setup program. See the user manual of your IDE controller or sound card for instructions.*

- 6. If you have a sound card which has a Sound Blaster compatible 4-pin "Audio-In" connector, use the supplied audio cable to connect "AUDIO" on the back of the drive to "Audio-In" of the sound card.
- 7. If you have an audio device (e.g., a sound card or a recorder) which supports digital audio input, you may optionally connect "DIGITAL AUDIO" on the back of the drive to the digital input connector of that device with an audio cable

PHILIPS CD-ROM DRIVE USER'S MANUAL

---

that has two 2-pin Molex or equivalent connectors.

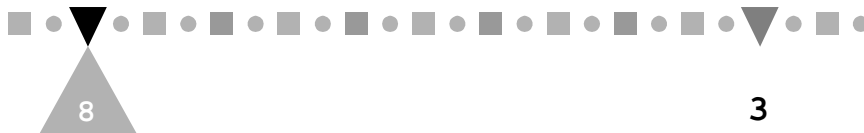

## INSTALLING YOUR DRIVE

8. Secure the drive with the supplied four screws.
9. Replace your PC's casing and reconnect the power supply.

This completes the hardware installation.



*Wait a minute. You haven't told me what the leftmost thing in the picture is about!*



*Don't panic. That's just a jumper reserved for our own testing. You don't need to do anything to it.*

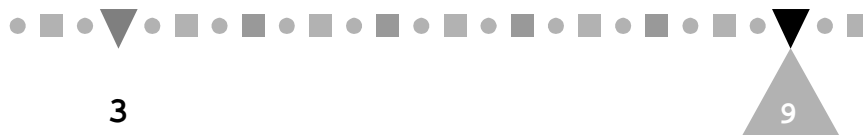



## 3.2 Letting Your System Recognize the Drive

For your system to recognize the new CD-ROM drive, you need an appropriate driver to act as the system's "eye opener." Because your new CD-ROM is a plug-and-play device, in normal cases either Windows 95 or OS/2 Warp should have no problem recognizing it with the OS's built-in standard IDE CD-ROM driver. Users of DOS and Windows 3.1, however, need to install a supplied device driver. Even so, the installation procedure is easy and takes less than three minutes.

### 3.2.1 If You Are a DOS or Windows 3.1 User

Perform the following steps:

1. Boot your computer.
2. Insert the Installation diskette into a 3.5" floppy drive.
3. Type `A:/SETUP <ENTER>` or `B:/SETUP <ENTER>`, depending on into which drive you inserted the diskette.

The CD-ROM Device Driver Setup menu appears:



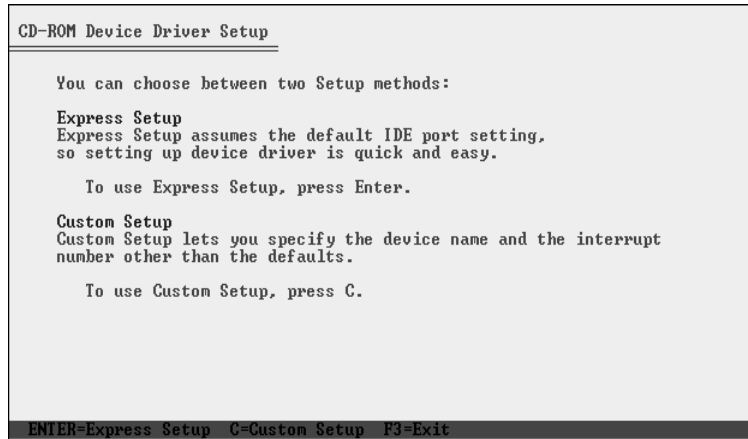

Figure 3-3 The "CD-ROM Device Driver Setup" Menu

4. Press <ENTER> to accept the default settings for an express setup, or press "C" to start a custom setup.

**Note:** *Custom Setup are only for users who want to change the default installation settings, such as the target directory or the IRQ lines to be used by the available IDE ports.*

A "Compile Time" message will appear when the setup is completed.

5. Reboot your computer.

If everything is okay, you can start using your CD-ROM drive right away. Otherwise:

- ⚡ If the file MSCDEX.EXE is indicated not found, make sure that you are using DOS 6.0 or above and your AUTOEXEC.BAT file has a path statement similar to:

```
PATH C:\DOS;
```

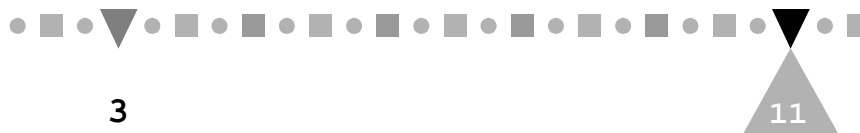

- ⚡ If the system halts, make sure that your CD-ROM drive has been correctly set as a master device or a slave device. See *Appendix A* for instructions.

If you still have trouble with your CD-ROM drive, contact the retail store where you bought your drive or call the help desk.



### 3.2.2 If You Are a Windows 95 User

Perform the following steps:

1. Install Windows 95, if it is not already installed.
2. Boot your computer. Windows 95 automatically starts.
3. Double click the My Computer icon on the desktop and check whether the CD-ROM icon appears as in the following window:

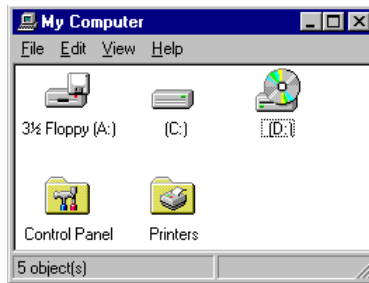
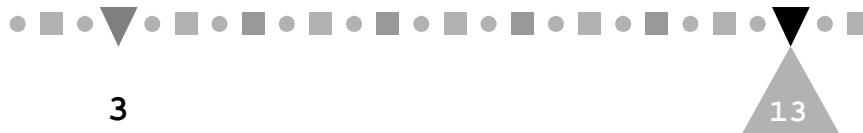
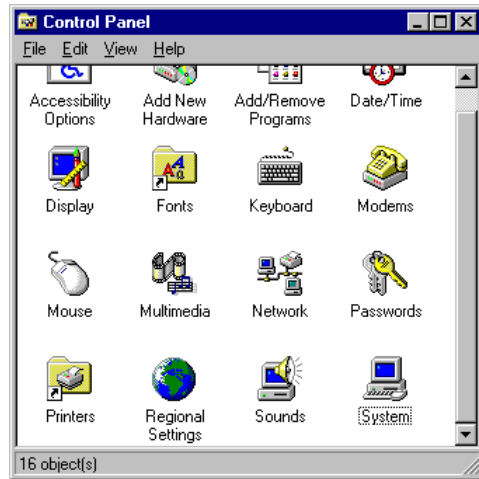

Figure 3-4 "My Computer" Peripherals

4. Double click the Control Panel folder in the same window. The Control Panel folder contents are displayed:





**Figure 3-5 The "Control Panel" Folder Contents**

5. Double click the System icon. The System Properties folder appears:

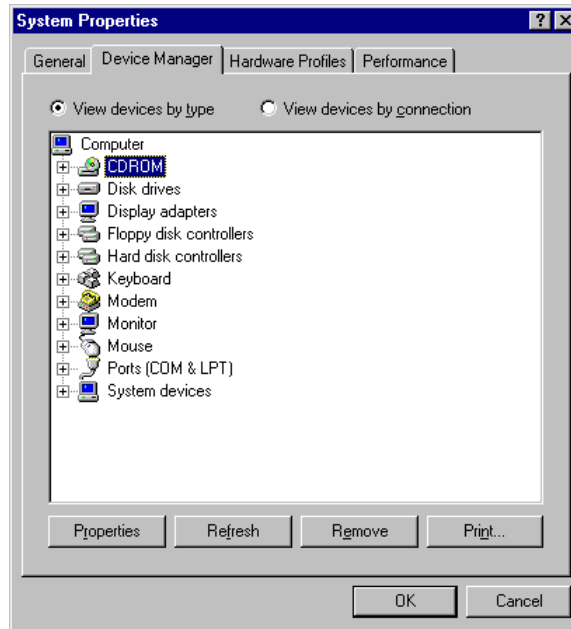

Figure 3-6 The "System Properties" Folder

6. Click the Device Manager tab and check whether the CD-ROM drive is listed.

If the CD-ROM icon is listed in both Step 3 and this step, you can stop here. Windows 95 has successfully recognized your new CD-ROM drive. Otherwise, proceed with Steps 7 and 8.

7. Install the supplied device driver under DOS by following the instructions given in Section 3.2.1.
8. Restart Windows 95 and repeat Step 3.

This time the CD-ROM icon should appear in My Computer's peripheral icon display (but not in the Device Manager's listing for reasons beyond this manual's purposes).



*Why couldn't I set up Windows 95 with its CD disc? Is my CD-ROM defective?*



*No. Your CD-ROM probably had nothing to do with that problem.*

*If you were making an upgrade from Windows 3.1 to Windows 95, you might have forgotten to complete the steps listed in Section 3.2.1 before performing the upgrade. Remember, without the CD-ROM driver, Windows 3.1 has no way to recognize your CD-ROM drive.*

*If you were setting up Windows 95 from scratch, the standard IDE CD-ROM driver contained in the Windows 95 installation package might not be working properly with your IDE controller. Try the diskette version.*

### 3.2.3 If You Are an OS/2 Warp User

Perform the following steps:

1. Install OS/2 Warp, if it is not already installed. Otherwise, skip to Step 3.

When the installation comes close to the end, the following dialog box pops up:

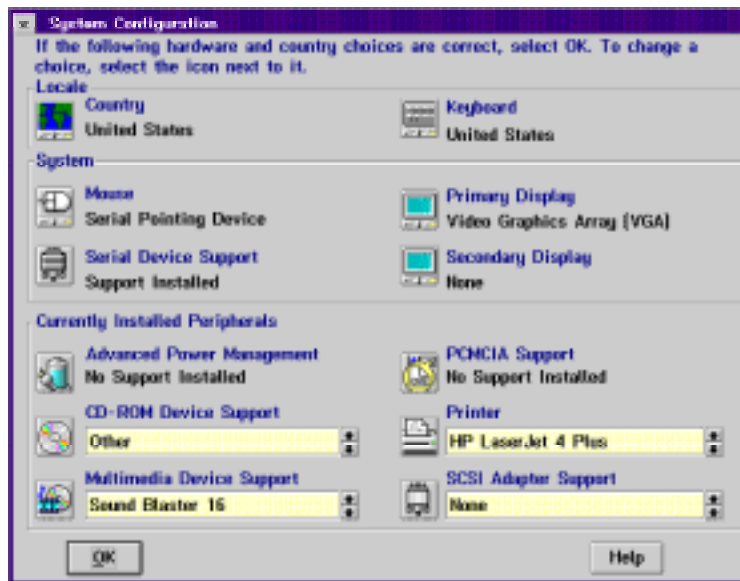

Figure 3-7 The "System Configuration" Dialog Box

2. Click the CD icon, select Other from the CD-ROM Device Support list box and click the OK button. Follow the screen instructions until the installation is completed.
3. Reboot your PC.



4. Double click the OS/2 System icon on the desktop to display the following window:

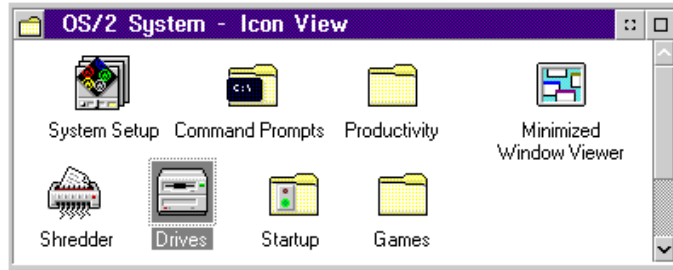

Figure 3-8 The "OS/2 System - Icon View" Window

5. Double click the Drives icon and check whether the CD-ROM icon (Drive D) appears as in the following list of available drives:

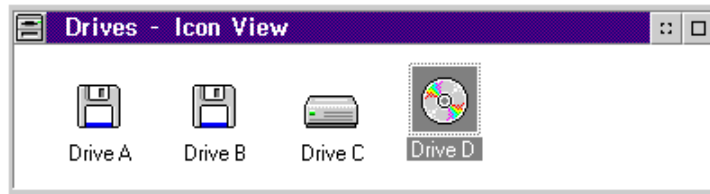

Figure 3-9 The "Drives - Icon View" Window

6. If it is listed, you can stop here. OS/2 Warp has successfully recognized your new CD-ROM drive. Otherwise, proceed with the remaining steps.
7. Close the window and double click the Command Prompts icon in the OS/2 System - Icon View window (see Figure 3-8). The following window appears:

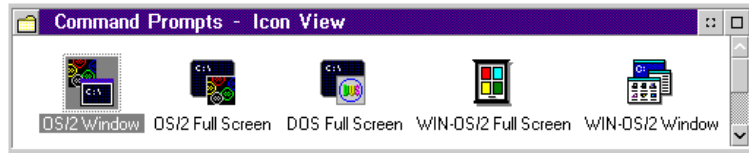

Figure 3-10 The "Command Prompts - Icon View" Window

8. Double click the OS/2 Window icon. An OS/2 window appears:

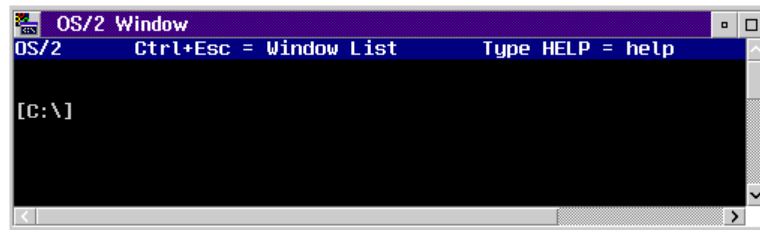

Figure 3-11 "OS/2 Window"

9. At the command prompt, type:  
`E CONFIG.SYS`
10. At the end of the opened CONFIG.SYS file, add the following line:  
`BASEDEV=IBMIDECD.FLT`
11. Close the file after saving it and reboot your PC.
12. Repeat Steps 4 and 5.  
This time the CD-ROM icon should appear as an available drive in the Drives - Icon View window.



*Why couldn't I set up OS/2 Warp with its CD disc? Is my CD-ROM defective?*



*No. Your CD-ROM probably had nothing to do with that problem.*

*Instead, the standard IDE CD-ROM driver contained in Diskette 1 of the OS/2 Warp installation package might not be working properly with your IDE controller. Try the diskette version.*

This page is intentionally left blank.



# USING YOUR CD-ROM DRIVE

# 4

## 4.1 Drive Applications

There are two main ways in which you will use your new CD-ROM drive. The first way is as a typical disk drive (albeit read-only). Here, data such as program files, databases, sound clips, video images, etc. is read from the CD into your PC's CPU. The other way is as a CD player. You can use your CD-ROM drive to listen to music CDs.

## 4.2 Front Panel Controls

Most of time, you will use application software to control the CD-ROM drive no matter whether the drive is used as a disk drive or a CD player. Nevertheless, there are times you will need to manually control the drive through its front panel controls.

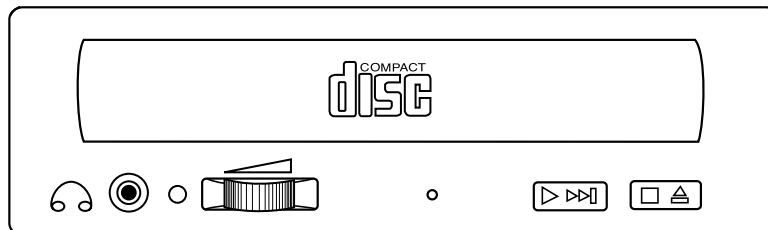

Figure 4-1 The Front Panel Look

These controls are (from top to bottom and from left to right):

**Disc Tray** Opens or closes for disc loading and removal





# A MASTER OR A SLAVE DEVICE?

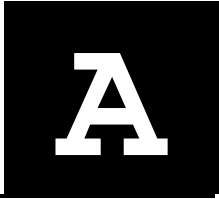

Before sliding your CD-ROM drive into the 5.25" drive bay, you have to decide whether the drive is going to be a *master* or *slave* device by adjusting the MA and SL jumpers on its back. This appendix presents some basic concepts of IDE connections to help you make the decision and describes the way to set the jumpers.

## A.1 IDE Connections

When you open your PC box, most likely you will see a wide ribbon cable with two 40-pin connectors stemming from a connector seat on the motherboard; each of the connectors may or may not have been connected to a peripheral device. Such a cable is called an IDE cable and the connector seat an IDE port. The functionality of the cable and port is determined by an "IDE controller", either built-in on your motherboard or in the form of an add-on card. This whole set of things acts as a data bridge between your CPU and devices that are designed for use with the IDE standards.

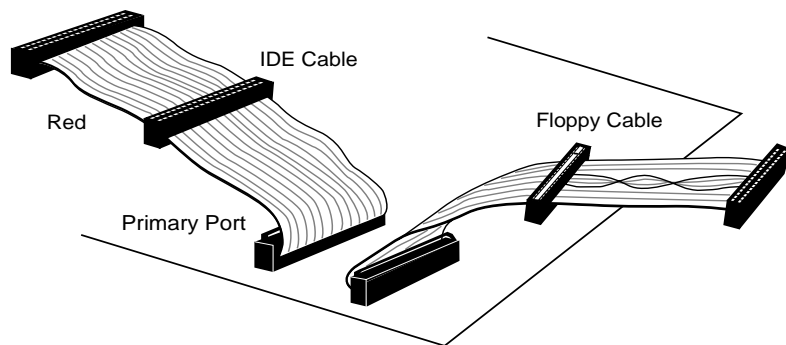

Figure A-1 IDE Port and Cable on Motherboard

PHILIPS CD-ROM DRIVE USER'S MANUAL

---



IDE controllers may contain more than one port and hence contain more than one IDE cable. Such a controller is called an enhanced IDE controller. Its ports are called the primary port, secondary port, tertiary port, etc. Currently, most enhanced IDE controllers contain two ports: the primary port and the secondary port. Any "bonus" port that comes with a peripheral device, for example, your sound card, is taken as a secondary port.

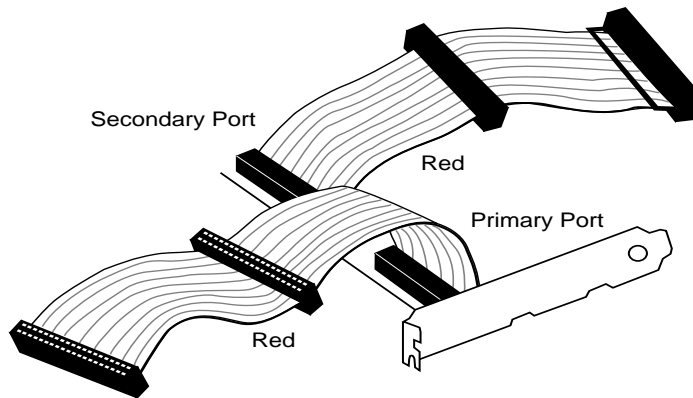

Figure A-2 Enhanced IDE Controller Card

**Note:** *Your PC system can have only one port of each kind at any time. If you add an enhanced IDE controller to the system, you must remove or disable the PC's original port(s). Similarly, if a "bonus" port is present, you must disable either this port or the PC's secondary port, if your PC already has a secondary port.*

Because each IDE port supports up to two devices, you need to tell your PC whether a device you are connecting is the master or the slave device of that port. As a result, if you have more than one IDE



device, their assignments may look similar to the following:



Device 1	Primary master (boot drive)
Device 2	Primary slave
Device 3	Secondary master
Device 4	Secondary slave
Device 5	Tertiary master
Device 6	Tertiary slave
⋮	⋮

Note that the primary master, if configured, must be a boot drive (normally a hard disk). Other than this, an IDE device can be configured to any IDE interface port and either as a master or a slave at your own choice. Here master and slave do not imply any operating precedence; they are just the "sub-IDs" of the devices that your computer needs to know about.

- Note:**
1. *Currently, a CD-ROM drive cannot be used as a boot drive. Therefore, you cannot configure the CD-ROM drive as the primary master.*
  2. *Your CD-ROM can be attached to any IDE controller that supports up to eight IDE devices.*
  3. *If you are using OS/2 Warp and another device has already been configured as the primary slave, we highly recommend that you configure the CD-ROM drive as the master device of one of the rest available IDE ports.*

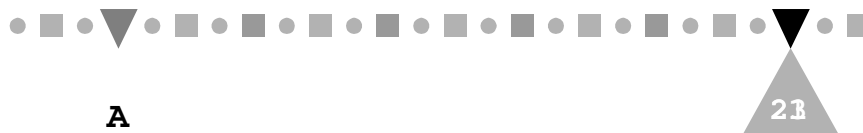

## A.2 Setting Master and Slave Jumpers

Whether your PC system regards your CD-ROM drive as a master device or a slave device depends on which of the "MA" (master) and "SL" (slave) jumpers on the back of the drive is capped.

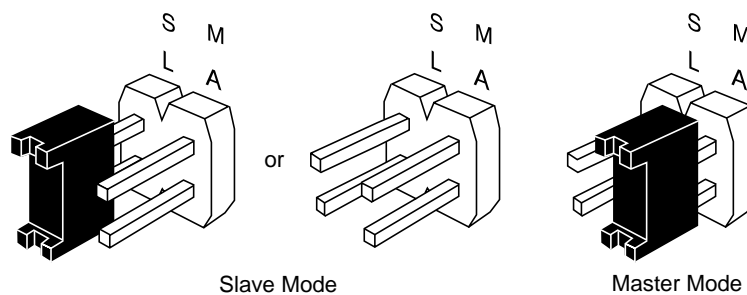

Figure A-3 Jumper Settings of Slave Mode and Master Mode

Your CD-ROM drive is shipped with the "SL" jumper capped. In spite of this, note from Figure A-3 that capping the "SL" jumper is optional for Slave mode.

To set your CD-ROM drive as a master device, simply remove the cap from the "SL" jumper and place it over the "MA" jumper.

- Note:**
1. The "MA" and "SL" jumpers cannot be both capped at the same time.
  2. A system halt will occur if the "MA" or "SL" jumper is set in conflict with the other device connected to the same IDE port. An IDE port cannot contain two master devices or two slave devices at any moment of time.





## SPECIFICATIONS

---

### Interface

**Drive interface type:** ATAPI IDE (conforms to SFF8020 V1.2)

**Disc formats:** Audio-CD, CD-ROM (mode 1 and mode 2)  
CD-ROM/XA (mode 2, form 1 and form 2)  
Video-CD, CD-i/FMV (CD-i movies)  
CD Plus  
Photo-CD (single and multisession)

**Disc size:** 80 and 120 mm

### Performance

**Data transfer rate:** 1,200 KB/sec (8X), 1,500 KB/sec (10X)

**Access time:** 155 ms typical @ 1/3 stroke (8X)  
145 ms typical @ 1/3 stroke (10X)

**Buffer size:** 128 KB

### Audio Features

**Signal to noise ratio:** 70 dB min

**Distortion:** < 2%

**Line output:** > 0.7 Vrms

**Digital output:** > 0.5 Vrms

**Headphone output:** > 0.8 Vrms

**Sampling frequency:** 44.1 KHz

**Output ports:** 3.5 mm stereo headphone jack  
4-pin stereo line out connector  
2-pin stereo digital audio output connector

### Power Requirements



**PHILIPS CD-ROM DRIVE USER'S MANUAL**

---

**DC 5V +/- 5%:** 500 mA typical  
**DC 12V +/- 5%:** 350 mA typical (8X), 900 mA typical (10X)



## Reliability

**MTBF:** 100,000 POH (25% duty cycle at room temperature)

**Error rate:**  $10^{-15}$  after error correction  
 $10^{-12}$  hard read error

## Environmental Tolerance

	Operating	Non-operating
<b>Temperature:</b>	+5 °C ~ +40 °C +41 °F ~ +104 °F	-20 °C ~ +55 °C -4 °F ~ +131 °F
<b>Humidity:</b>	20% - 80% RH, non-condensing	15% - 80% RH, non-condensing

## Physical Characteristics

**Dimension:** 146 x 42.5 x 210 mm (W x H x D)  
typical

**Weight:** 0.9 Kg

**Front panel:** Stop/Eject button  
Audio Play/Skip button  
Emergency disc eject hole  
Rotary volume control knob  
Disc Ready/Data Seek LED indicator  
Headphone jack

**Rear Panel:** Power supply connector  
IDE interface connector  
Master/Slave configuration jumpers  
Audio line output  
Digital audio output  
Testing jumper

