



Internal CD-ReWritable kit
CDRW400
series

 **CDRW400**
Series

Owner's manual
Bedienungsanleitung
Mode d'emploi
Istruzioni per l'uso
Gebruiksaanwijzing
Instrucciones de manejo



Let's make things better.



PHILIPS

LASER SAFETY

This CD-RW drive employs a laser. Do not remove the cover or attempt to service this device when connected due to the possibility of eye damage.



**CLASS 1
LASER PRODUCT**

CAUTION

USE OF CONTROLS OR ADJUSTMENTS OR PERFORMANCE OF PROCEDURES OTHER THAN THOSE SPECIFIED HEREIN MAY RESULT IN HAZARDOUS LASER RADIATION EXPOSURE.

CAUTION

LASER RADIATION WHEN OPEN AVOID EXPOSURE TO BEAM.



FOR EUROPE

The CD-RW drive is in conformity with the EMC directive and low-voltage directive.

COMPLIANCE INFORMATION STATEMENT
(DECLARATION OF CONFORMITY PROCEDURE)

Responsible Party: Philips BU PC Add-Ons.
Address: Glaslaan 2, 5616 LW Eindhoven
Type of Equipment: CD Rewriter
Model Name: Philips CD Rewriter

This device complies with Part 15 of the FCC Rules. Operation is subject to the following conditions:

- 1) this device may not cause harmful interference, and
- 2) this device must accept any interference received including interference that may cause undesired operation.

See user manual instructions if interference to radio reception is suspected.

FCC INFORMATION (U.S.A.)

1. IMPORTANT NOTICE: DO NOT MODIFY THIS UNIT!

This product, when installed as indicated in the instructions contained in this manual, meets FCC requirements. Modifications not expressly approved by Philips may void your authority, granted by the FCC, to use the product.

2. IMPORTANT: When connecting this product to accessories and/or another product use only high quality shielded cables. Cable/s supplied with this product **MUST** be used. Follow all installation instructions. Failure to follow instructions could void your FCC authorization to use this product in the USA.

3. NOTE: This product has been tested and found to comply with the requirements listed in FCC Regulations, Part 15 for Class "B" digital devices. Compliance with these requirements provides a reasonable level of assurance that your use of this product in a residential environment will not result in harmful interference with other electronic devices. This equipment generates/uses radio frequencies and, if not installed and used according to the instructions found in the users manual, may cause interference harmful to the operation of other electronic devices. Compliance with FCC regulations does not guarantee that interference will not occur in all installations. If this product is found to be the source of interference, which can be determined by turning the product "OFF" and "ON", please try to eliminate the problem by using one of the following measures: Relocate either this product or the device that is being affected by the interference.

Utilize power outlets that are on different branch (circuit breaker or fuse) circuits or install AC line filter/s.

In the case of radio or TV interference, relocate/reorient the antenna. If the antenna lead-in is 300 ohm ribbon lead, change the lead-in to coaxial type cable.

If these corrective measures do not produce satisfactory results, please contact the local retailer authorized to distribute this type of product. If you can not locate the appropriate retailer, please contact Philips.

This manual applies to the Philips CD Rewriter. The Philips CD Rewriter front panel displays the Philips brand

WARNING

Warning

The temperature where your Philips CD Rewriter is located should be between 5°C and 40°C (41°F – 104°F), when used in a fan-cooled system.

To reduce the risk of electric shock do not disassemble the Philips CD Rewriter cabinet.

Always remove the disc before transporting your Philips CD Rewriter.

IMPORTANT PRECAUTIONS

Important Precautions

Please read the following precautions before attempting to operate your Philips CD Rewriter.

- Always record in a dust-free environment. If the disc must be removed from the Philips CD Rewriter before recording is finished, store the disc in a clean, dust-free environment.
- Your Philips CD Rewriter contains no user serviceable parts. Please refer all servicing to qualified personnel.
- If any of the following should occur, your Philips CD Rewriter should be serviced by qualified personnel:

Metal objects or liquids get inside the Philips CD Rewriter.

Your Philips CD Rewriter does not operate normally or a marked change in performance is noticed.

- Do not place heavy objects on the CD-RW discs.
- Do not subject your Philips CD Rewriter and computer to impact or shock when in use, as this may impair recording or playback.
- Philips is not responsible for any data or information losses resulting from the operation of your Philips CD Rewriter.

Table of Contents

English

Introduction	4
Philips CD Rewriter Features	4
Recording Modes	4
Chapter 1 - System Configuration	5
Computer	5
Software	5
Tools	5
Discs	6
Chapter 2 - Installing your Philips CD Rewriter Drive	7
MASTER/SLAVE settings	7
Installing your Philips CD Rewriter drive	9
Chapter 3 - Operation	14
Front Panel	14
Loading a Disc	15
Ejecting the Disc	16
Manual Eject (emergency use)	16
Troubleshooting	17
Appendix	18
Specifications	18
Front Panel Indicator Key	19

©1998 Philips Consumer Electronics B.V. All Rights Reserved.

This document may not, in whole or in part, be copied, photocopied, reproduced, translated, transmitted or reduced to any electronic medium of machine readable form without prior consent in writing from Philips.

MS-DOS and Windows are registered trademarks of Microsoft, Inc.

Unix is a registered trademark of UNIX System Laboratories.

All other trademarks are the property of their respective companies.

Introduction

Thank you and congratulations for purchasing this Philips Philips CD Rewriter drive. Please read this manual before using the drive in order to make the best use of its superior functions. After reading, we suggest you retain this manual for future reference.

Philips CD Rewriter Features

4 speed Recording (Rewritable) - 4 speed Recording (Recordable) - 16 speed Reading

Your Philips CD Rewriter is able to write (overwrite) CD-RW discs at up to four speed, and is able to write CD-R and CD-RW discs at up to four speed. For both types of media, this drive is able to read at up to 16X speed.

Compatible with Seven Different Formats

Your Philips CD Rewriter can both record and read seven different formats: CD-ROM, CD-ROM XA, CD-I, CD-DA, CD-Bridge (multisession), CD-Extra, and Video CD. Your Philips CD Rewriter is also equipped with an analog audio output terminal (headphones) for CD-DA.

ATAPI for High-Volume, High-Speed Data Transfer

Your Philips CD Rewriter features an ATAPI/IDE interface for connecting computers and peripheral devices. ATAPI provides high-speed transmission of large quantities of data, which is especially important when working with image data.

Recording Modes

Track at Once

In this mode, data can be recorded to disc one track at a time. Discs recorded in this mode cannot be played in CD players or CDRom drives other than a CD-RW or a CD-R drive until the session is closed.

Disc at Once

In this mode, data can be recorded to an entire disc in one pass. It is not possible to write additional data later.

Session at Once

In this mode, data can be recorded to the disc one session at a time. To use this mode, your software must support Session at Once recording. New sessions can be written later.

Packet Writing

This is useful for data back-up. Smaller units of data can be added to tracks. To use this mode, your software must support Packet Writing. Your Philips CD Rewriter supports both sequential and random packet writing.

Chapter 1.

System Configuration

Before using your Philips CD Rewriter, make sure that you have all of the items on the list of included items.

In order to use your Philips CD Rewriter, you will require the following.

Computer

The following operating environment is required:

- An IBM/AT compatible computer with a 100 MHz or faster Pentium CPU, or a 100 MHz or faster 486 CPU
- A vacant IDE interface connector
- A vacant half-height bay
- Windows 98, Windows 95, Windows NT4.0 or Higher
- Sufficient hard disk space

Note: You will need about twice as much space on your hard disk as that required by the data you wish to write to CD

Software

The Philips CD-RW software packed with your Philips CD Rewriter has been carefully designed to give you the best possible results with the maximum ease of use.

Tools

Cruciform screwdriver

This is used to remove the cover of your computer, and to install your Philips CD Rewriter drive.



Cruciform Screwdriver

Long nose pliers

These are used to insert or remove the jumper pin when setting the MASTER/SLAVE settings of your Philips CD Rewriter drive.

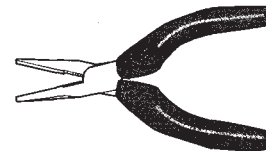

Long nose pliers

Discs

You may use conventional CD-RW and CD-R discs with your Philips CD Rewriter.

Philips recommends you use only Philips CD-RW and CD-R discs which are available at your retailer



CD-RW Discs

(ø120mm, 74 minutes)

CD-R Discs

(ø120mm, 74 minutes)

Read-only Discs

You can use discs with the  logo which conform to the Compact Disc Read Only Memory standard. If you wish to use the audio functions, use discs with the  logo, which conform to the Compact Disc Digital Audio standard.

Chapter 2.

Installing your Philips CD Rewriter Drive

MASTER/SLAVE settings

Before you install your new Philips CD Rewriter in your computer, you must first make the MASTER/SLAVE setting.

This setting is set by inserting a jumper pin in the jumper switch located on the rear panel of the Philips CD Rewriter drive.

Important: *When the unit is shipped from the factory, this setting is in the MASTER position.*

Note: *Use long-nose pliers to remove or insert the jumper pin.*

Rear Panel

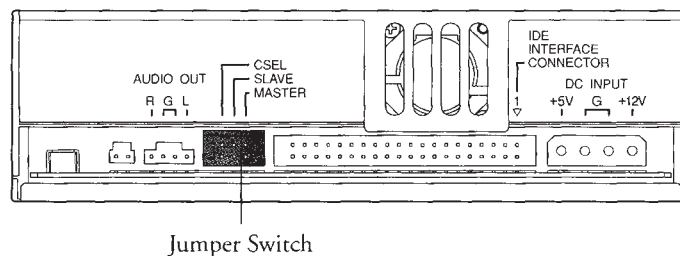

Enhanced IDE compatible computers normally have two IDE interface connectors; a primary one and a secondary one.

Each IDE interface connector of the host computer allows up to two IDE devices to be connected. This means that a total of up to four IDE devices can be connected.

Normally, a hard disk is connected to the primary connector, and a CDROM drive is connected to the secondary connector.

Important: *Avoid connecting your Philips CD Rewriter or a CD-ROM drive to the same primary connector as the hard disk drive.*

In order to take full advantage of the system's performance, we recommend that you connect your Philips CD Rewriter to the secondary connector by itself as the MASTER.

Make sure that any other drives that are connected to the same cable have their jumper settings set to SLAVE. Verify each respective drive's owner's manual for instructions on jumper settings.

Setting your Philips CD Rewriter as the MASTER

As shown in the diagram at the right, insert the jumper pin into the right edge of the jumper switch.

Note: If only your Philips CD Rewriter will be connected to the IDE interface connector, connect the Philips CD Rewriter to the end of the connector.

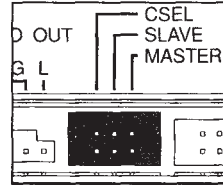

Setting the Philips CD Rewriter as the SLAVE

As shown in the diagram at the right, insert the jumper pin into the middle of the jumper switch.

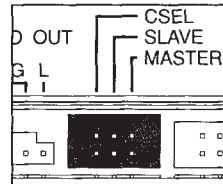

CSEL (Cable SElect)

If you choose the CSEL setting, the MASTER/SLAVE setting will be made automatically depending on your hardware configuration. For details refer to the user manual of your computer.

Installing your Philips CD Rewriter drive

The following steps may differ slightly, depending on the type of computer you are using. For details on removing the cover from your computer, and installing or removing internal devices, refer to the user manual for your computer.

1. Switch off your computer, and unplug it from the mains power outlet.

If you fail to do this, there is a danger of electric shock and/or of causing short circuits, which may damage the computer and/or your Philips CD Rewriter drive.

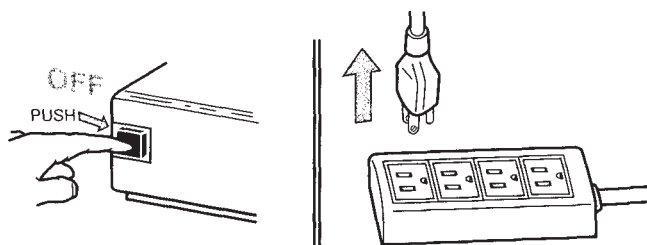

2. Remove the cover from your computer.

Be careful not to lose the screws that were removed.

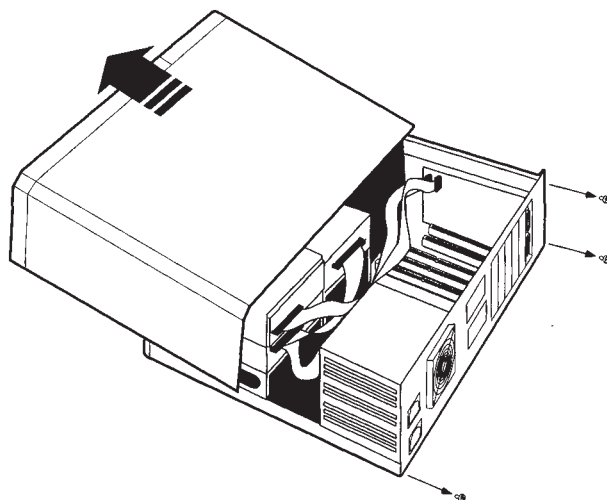

3. Your hands or body may be holding a charge of static electricity.

Touch a metallic portion of the chassis or the power supply to discharge the build up.

4. Remove the front cover of a vacant half-height drive bay.

For details refer to the user manual of your computer.

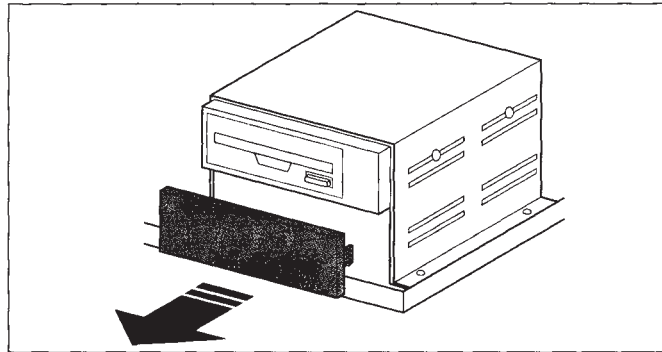

5. Slide your Philips CD Rewriter into the drive bay from the front.

At this time, be careful not to apply excessive force to the drive itself. Finger-tighten the four fastening screws, and check that there is enough room to connect the power supply cable, IDE interface connector, and the AUDIO cables.

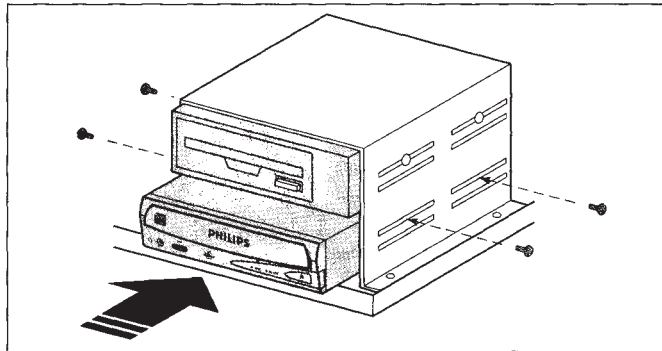

6. Connect the IDE interface connector.

Connect the 40-pin IDE interface connector to the IDE interface located on the rear panel of your Philips CD Rewriter drive.

Position the connector so that the colored line is at pin 1 (your lower right).

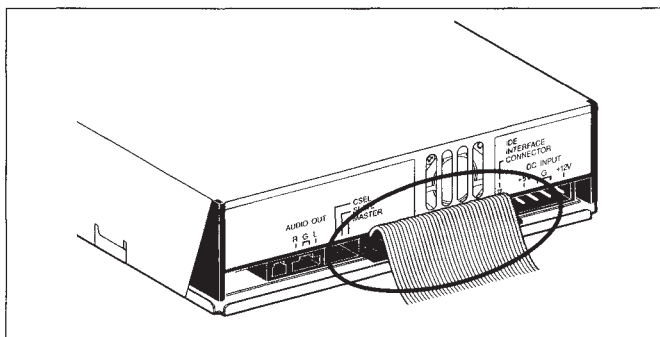

7. Connect the AUDIO cable.

Connect the single 4-pin connector (Sound Blaster compatible) to the sound card.

Connect the 4-pin connector at the other end of the cable (the larger connector) to the AUDIO OUT connector on your Philips CD Rewriter drive. The polarizing lug should be at the top.

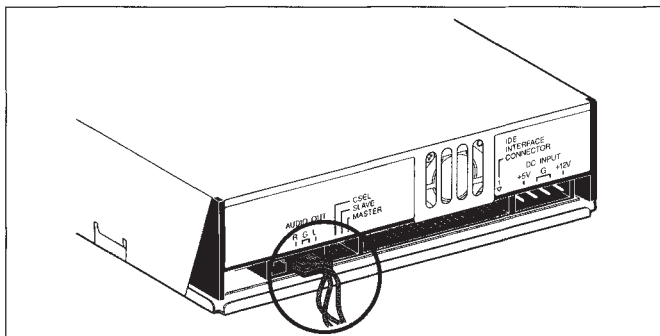

AUDIO cable

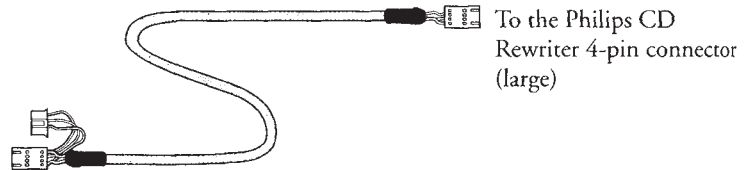

To the Philips CD
Rewriter 4-pin connector
(large)

To the Sound Card (Sound Blaster compatible)
One of the 2 connectors

8. Connect the power supply cable.

Connect the +12V and +5V 4-pin power cable to the power supply interface located on the rear panel of your Philips CD Rewriter drive.

The shape of the connector makes it impossible to reverse the connections.

If you have difficulty when inserting the connector, try gently wiggling the connector left and right while inserting it.

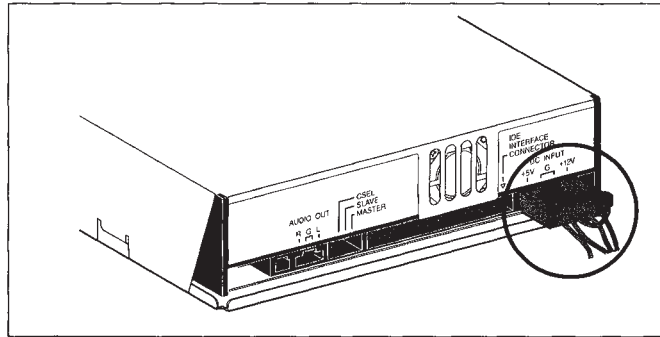

9. Tighten the four fastening screws securely.

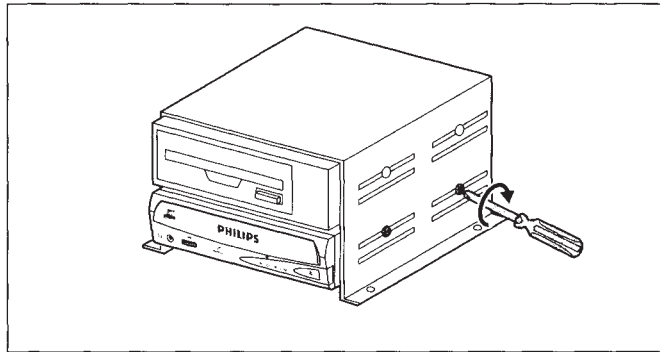

10. Re-attach the cover to the computer.

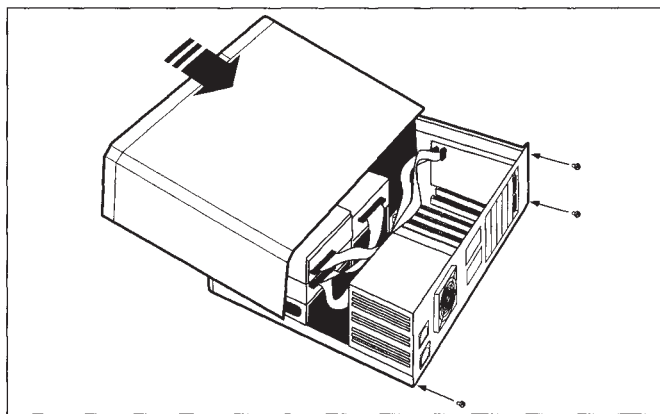

11. Connect the power cable to an AC outlet, and switch on your computer.

Make sure that the LED located on the panel of your Philips CD Rewriter drive is lit.

12. Start up your operating system.

For the procedure, refer to the manual for your operating system.

13. Install your Philips CD recording software

For the installation procedure, refer to the easy installation instructions on the CD-ROM sleeve or simply insert the software CD in your computer's CD-ROM drive. The software installation process will then begin automatically; just follow the on-screen prompts. In addition, a complete user manual for the software is located on the CD-ROM in the root directory under "Manual". Simply click on the language you wish to use.

Chapter 3. Operation

Front Panel

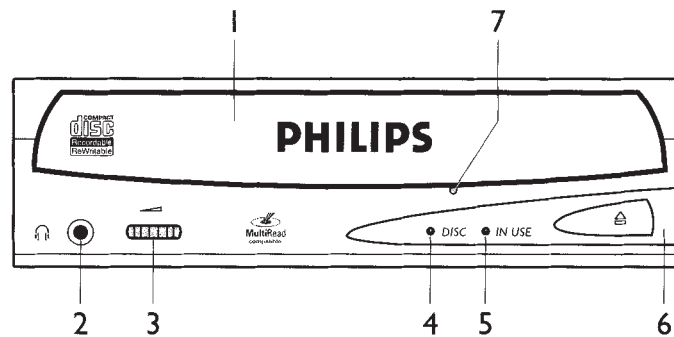

1 Disc tray

The disc is inserted and ejected here. Pressing the eject button will open the tray.

2 Headphone jack

This stereo mini jack allows you to connect headphones and listen to audio CD output.

3 Headphone volume control wheel

This control adjusts the volume level of the headphone output. Rotating the control wheel clockwise (to the right) will increase the volume level.

4 ON/DISC LED

This indicator lights-up in orange when your Philips CD Rewriter is powered-up, and lights-up in green when the Philips CD Rewriter contains a disc.

5 READ/WRITE LED

This indicator lights-up in green when data is being read, and flashes when data is being accessed. It also lights-up in orange when data is being recorded on a disc.

6 Eject button

This button is used to open or close the tray.

7 Manual Eject port

This is used to manually eject a disc that cannot be ejected in the normal way. It is for emergency use only.

Loading a Disc

1. Press the eject button to open the tray.
2. Carefully place the disc, label-side up, on the disc tray.
3. Press the disc tray softly or press the eject button again to close the disc tray.

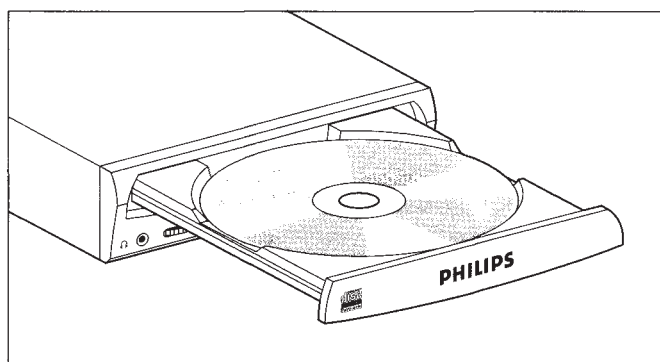

Ejecting the Disc

If your Philips CD Rewriter is powered-up:

Press the eject button to eject the disc.

Note: You cannot open the tray if the ATAPI command prohibits the eject operation while your Philips CD Rewriter is reading data.

Caution: Be sure to remove the disc only after the tray is completely open. (Attempting to remove the disc before it is completely ejected may cause the drive to malfunction.)

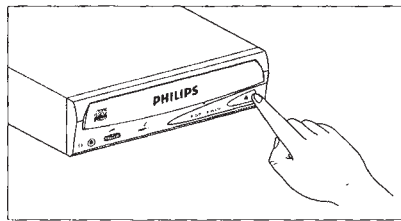

Press the eject button

If your Philips CD Rewriter is not powered up:

Pressing the eject button will not eject the disc.

Manual Eject (emergency use)

We will explain below how to eject the disc when the tray cannot be opened in the normal manner, for example if the power is shut-off inadvertently or the loading mechanism fails. This technique should be used only as a last resort. Frequent use may lead to malfunction. You will need a pin-like object of 2 mm or less in diameter to do this. A straightened paper clip works well.

1. Insert the pin-like tool into the manual eject port and push gently.

The spring-loaded mechanism ejects the disc.

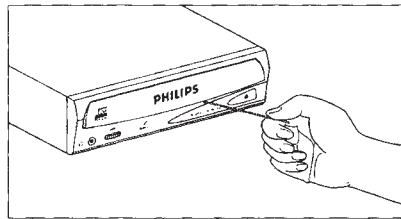

2. After manually ejecting a disc, you must turn off the power supply to your Philips CD Rewriter, then turn it back on before continuing.

Troubleshooting

If your Philips CD Rewriter is not performing as expected, we suggest you look up the symptoms in the following table, and take the appropriate corrective action.

Symptoms	Corrective action
The power to your Philips CD Rewriter is off	- Check the DC power cable connection.
Your Philips CD Rewriter is not recognized by your computer	- Check the IDE interface connection. - Is the MASTER/SLAVE setting correct? - If there is only one device connected to the IDE interface connector, is it connected to the end of the connector?
The disc tray will not open	- Make sure that the power to the drive is turned on.
The disc ejects by itself	- Make sure that the disc is seated in the tray correctly.
Incorrect operation of the unit	- Make sure that the disc is seated in the tray correctly. - Make sure that you are using the correct disc. - Make sure that there is no dust, dirt, or condensation on the disc or tray.

Appendix

Specifications

Interface	ATAPI (E-IDE)
Data Capacity	650MB (74 minutes disc)
Record/Read Speed	Writing (CD-RW): 4X speed Writing (CD-R): Normal speed, 4X speed Reading: Maximum 16X speed (CD-DA: 1X speed only)
Data Transfer Rate	150 - 2400KB/sec
Burst Transfer Rate	Maximum 13.3 MB/sec
Buffer Size	2MB (325 sectors)
Access Speed	160 ms (Random access at reading)
Installation	Horizontal
Disc Loading	Tray
Audio Out (normal speed)	Frequency Response 20 - 20,000Hz (Line Out) Output Level 1 Vrms (Line Out)
Power Consumption	11 W (read/write)
Power Supply	5V±5%, 12V±10%
Environment	Temperature: +5°C - +40°C (read/write, when used in a fan-cooled system) Humidity: 5 - 85% (condensation must not occur)
Dimensions (WxHxD)	146 x 41.3 x 193.1 mm (excluding front panel)
Weight	950g

Philips reserves the right to change product specifications at any time and without prior notice.

Front Panel Indicator Key

● on: green ■ flashing: green — off
 ○ on: orange □ flashing: orange

Status	ON/DISC	READ/WRITE
Reset	○ ⇄ —	○ ⇄ —
Ready (no disc)		—
Inserting disc	□ ⇄ ■	—
Ejecting disc	□	—
Ready (disc inserted)	●	—
Seeking	●	■
Preparing to write	●	□
Writing	●	■
Writing (test mode)	●	□
Playback	●	●

Thank you for purchasing this fine Philips product. We have worked relentlessly to bring you a product combining superb operating performance with the greatest possible ease of use.

If you have any questions or comments, please contact your retailer or Philips at the following Internet address: [Http://www.pcstuff.philips.com](http://www.pcstuff.philips.com).



Additional information available at our website:
www.pcstuff.philips.com

Specifications subject to change without notice.
All dimensions shown are approximate.

©1999 Philips Electronics N.V.
All rights reserved. Reproduction, copying, usage,
modifying, hiring, renting, public performance, transmission
and/or broadcasting in whole or part is prohibited
without the written consent of Philips Electronics N.V.

Printed in The Netherlands

3138 105 50136

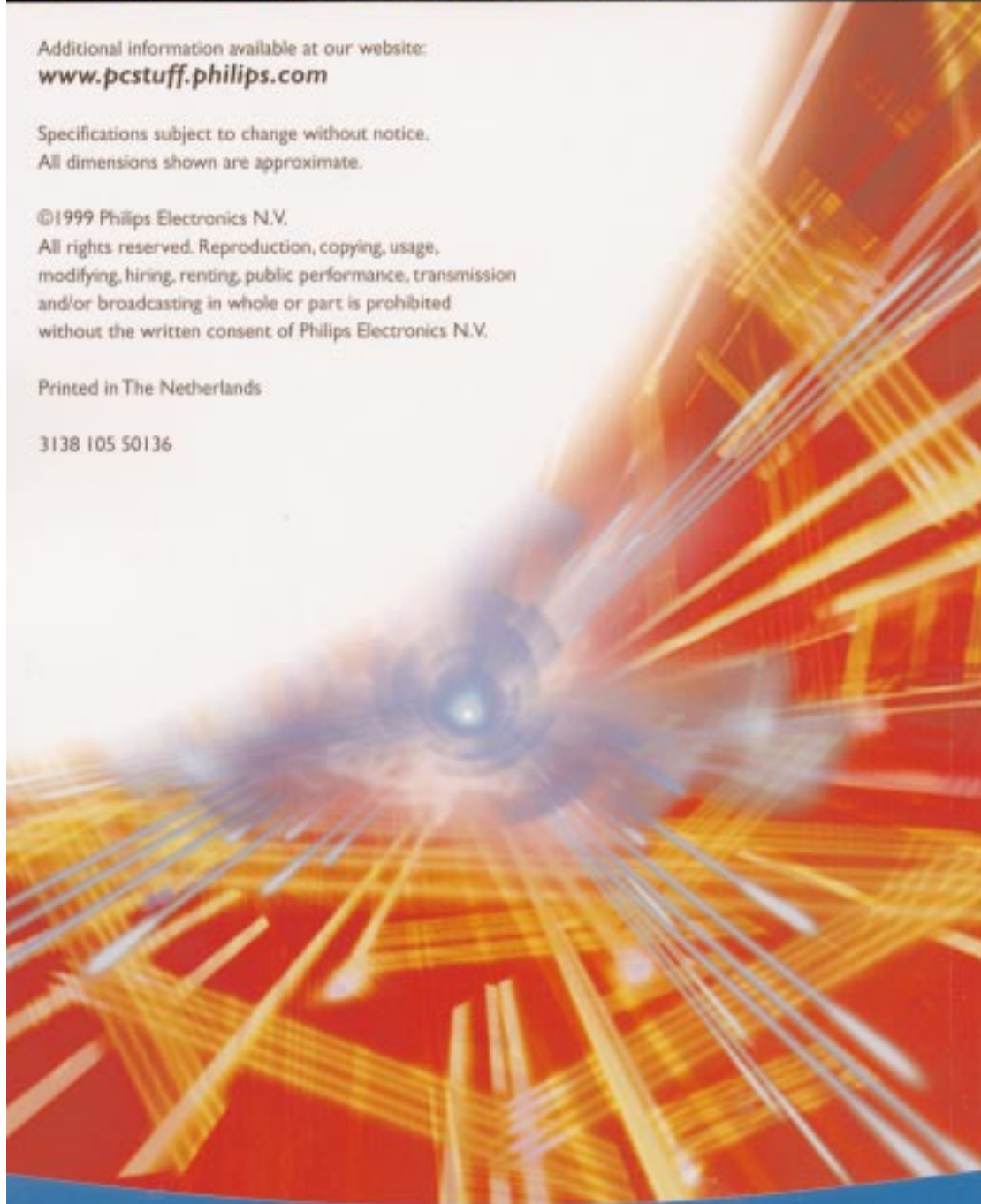

Let's make things better.



PHILIPS