

DVD/CD Rewritable Drive

Operating Instructions



DRU-720A

Safety Regulations

WARNING

You are cautioned that any changes or modifications not expressly approved in this manual could void your authority to operate this equipment.

To prevent fire or shock hazard, do not expose the unit to rain or moisture.

To avoid electrical shock, do not open the cabinet. Refer servicing to qualified personnel only.

CAUTION:

As the laser beam in the DRU-720A is harmful to the eyes, do not attempt to disassemble the cabinet. Refer servicing to qualified personnel only.

The use of optical instruments with this product will increase eye hazard.

The use of controls or adjustments or performance of procedures other than those specified herein may result in hazardous radiation exposure.

This label is located on the top of the drive unit enclosure.

Dieses Etikett befindet sich auf der Oberseite des Laufwerksgehäuses.

| | |
|------------------|---|
| CAUTION | CLASS 3B VISIBLE AND INVISIBLE LASER RADIATION WHEN OPEN. AVOID DIRECT EXPOSURE TO THE BEAM. |
| ATTENTION | RADIATIONS LASER VISIBLES ET INVISIBLES DE CLASSE 3B EN CAS D'OUVERTURE. EVITER TOUTE EXPOSITION DIRECTE AU FAISCEAU. |
| VORSICHT | KLASSE 3B SICHTBARE UND UNSICHTBARE LASERSTRAHLUNG WENN GEÖFFNET. DIREKTEN KONTAKT MIT DEM STRAHL VERMEIDEN. |
| ADVARSEL | SYNLIG OG USYNLIG LASERSTRÅLING AF KLASSE 3B VED ÅBNING. UNDGÅ DIREKTE UDSÆTTELSE FOR STRÅLING. |
| ADVARSEL | SYNLIG OG USYNLIG LASERSTRÅLING I KLASSE 3B NÅR DEKSEL ÅPNES. UNNGÅ DIREKTE EKSPONERING FOR STRÅLEN. |
| WARNING | KLASS 3B SYNLIG OCH OSYNLIG LASERSTRÅLNING NÅR DENNA DEL ÄR ÖPPNAD. UNDVIK ATT DIREKT EXPONERA DIG FÖR STRÅLNINGEN. |
| VARO! | AVATTUNA LUOKAN 3B NÄKYVÄÄ JA NÄKYMÄTÖNTÄ LASERSÄTEILYÄ. VÄLTÄ SUORAA ALTISTUMISTA SÄTEELLE. |

The DRU-720A is classified as a CLASS 1 LASER PRODUCT.
The CLASS 1 LASER PRODUCT label is located at the top of the enclosure.

Bei diesem DRU-720A handelt es sich um ein Laser-Produkt der Klasse 1.
Das Etikett mit der Aufschrift LASER KLASSE 1 PRODUKT befindet sich auf der Oberseite des Gehäuses.



LUOKAN 1 LASERLAITE

KLASS 1 LASER APPARAT

CE Sicherheitsbestimmungen

Diese Ausrüstung erfüllt die Europäischen EMC-Bestimmungen für die Verwendung in folgender / folgenden Umgebung(en):

- Wohngegenden
- Gewerbegebiete
- Leichtindustrialgebiete

(Diese Ausrüstung erfüllt die Bestimmungen der Norm EN55022, Klasse B.)

Table of Contents

Safety Regulations 2

Updating the Firmware29

Turbo Boost Function29

Introduction

Unpacking the Package Contents ... 6

Features 6

System Requirements 7

Part Names and Functions 8

Setup

Setting up the Drive 10

Appropriate Jumper Settings 15

Replacing your current optical drive with the DVD/CD rewritable drive 15

Installing the DVD/CD rewritable drive as a second drive 16

Installing the DVD/CD rewritable drive as a third drive 17

Installing the DVD/CD rewritable drive as a fourth drive 18

Operation

Using the Drive 19

Supplied Software 19

Using Generic Software with the Drive 20

Compatible Discs 21

Recommended Writable Discs ... 23

Writable Disc Features 24

Precautions when Writing Data to Disc 27

Maximizing Performance 29

User Support Web Site 29

Miscellaneous

Precautions for Use30

Specifications31

Support Overview33

User Support Web Site33

Update the Drive Firmware33

Product and Support Information33

- **Power-Burn**_{c o n f o r m e d} is a trademark of Sony Corporation.
- Pentium is a registered trademark of Intel Corporation.
- Microsoft, MS, MS-DOS and Windows are registered trademarks of Microsoft Corporation.
- Other system and product names used herein are registered trademarks or trademarks of their respective manufacturers, although the ™ and ® marks are not used in the text.

- Our product warranty is valid only when the supplied accessories (including software) are used in the specified or recommended system environment, in accordance with the documentation, and applies only to this DVD/CD rewritable drive. Our customer service and user support apply only under these product warranty conditions.
- Please note that we cannot accept responsibility for failure of the computer or other devices, incompatibility with special hardware, operating problems caused by improper installation of software, loss of data, discs or other accidental or incidental damage that might occur when using this product.
- The guarantee and user support for this product are valid only within the countries or sales regions specified on the warranty card.
- Copyright laws prohibit the copying in part or in full of the supplied software and documentation, or loaning the software, without obtaining permission of the copyright holder.
- We cannot accept responsibility for any direct or indirect financial damage or loss of profit that might occur when using the supplied software.
- The supplied software can only be used with this product.
- Specifications of the supplied software may be changed without notice in the interest of product improvement.

Please Record Responsibly

Before copying anything onto a disc, please be sure that you are not violating copyright laws. Most software companies allow you to make a backup or archive copy of software. Check your software's license agreement for details.

► Introduction

Unpacking the Package Contents

Please verify that the package contains the following when unpacking. If any of these items appear to be missing and/or damaged, please contact your dealer.

- Drive

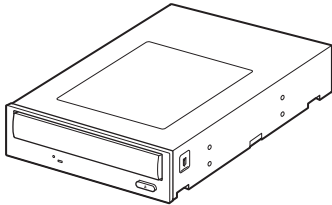

- 40-pin ATAPI (IDE) flat cable
- Screws (×4)
- Quick start guide
- Software quick start guide
- Operating instructions (this document)
- Front panel replacement guide
- Front panel replacement kit
- Software disc
- Warranty card

Note

Make sure that you back up the supplied software disc on another disc because the software disc is not distributed independently.

Features

This product offers the following features.

- An internal DVD/CD rewritable drive with ATAPI (EIDE) interface for computers.
- Can be used horizontally or vertically.
- The drive can write to DVD+R Double Layer discs.
- You can write at a maximum of 16× when using high speed DVD+R, DVD-R discs.
- The drive can write to seven types of disc.
- Features the **Power-Burn**_{conformed} technology to prevent buffer underrun errors.
- You can replace the front panel of the drive with the supplied replacement front panel.

System Requirements

The drive should be used with a system that meets the following requirements¹⁾.

- ❑ PC/AT-compatible computer
- ❑ CPU: Pentium III, 800 MHz or higher (with Nero Vision Express: Pentium 4, 1.6 GHz recommended)
- ❑ 256 MB RAM or more
- ❑ 1 GB (with Nero Vision Express: 10 GB) free hard disk space
- ❑ One available EIDE (ATAPI) interface connection with DMA capability²⁾
- ❑ One empty 5-inch half-height drive bay
- ❑ One available internal +12 V/+5 V power connector³⁾
- ❑ Operating system:
Windows 2000 Professional (referred to as Windows 2000),
Windows XP Home Edition or
Windows XP Professional (referred to as Windows XP)

- 1) The above requirements are the minimum necessary requirements to write to disc normally. Under actual operating conditions, the requirements imposed by your software must also be met. For details, refer to your software documentation.
- 2) The drive does not support connection to an ATAPI interface card. Connect the drive to the IDE (ATAPI) interface connector of your computer's motherboard.
- 3) The drive consumes a lot of power when operating at high speeds. You should therefore make sure that the rated power output of the power outlet where you connect all your drives is sufficient to power all the drives, including this one. For details about each drive's power consumption rating, refer to their documentation.

Part Names and Functions

Front Panel

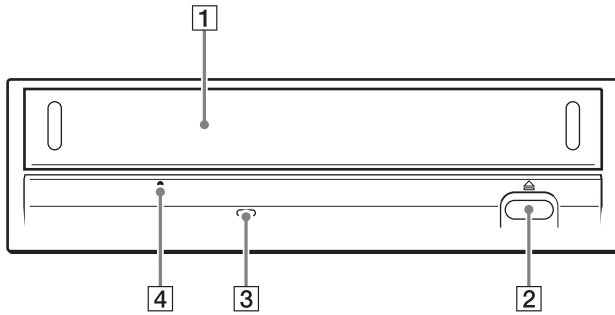

Rear Panel

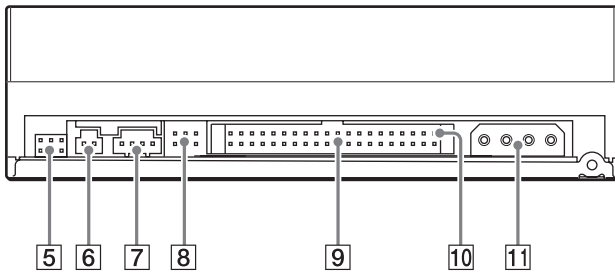

1 Disc tray

Insert discs here, label side up.

Hint

When you insert a disc into the drive, make sure that it is under the four pins. When using the drive vertically, make sure that you set the disc inside the two lower pins.

2 Eject button

Press to open and close the disc tray.

3 Busy indicator

Indicates the drive status.

Lit : The drive is reading data, playing back an audio CD, or writing packets.

Blinking: The drive is writing data (disc-at-once, track-at-once), formatting a disc, or deleting¹⁾ data from a disc.

Off : The drive is in a state other than those outlined above.

¹⁾ Some drives indicate this state with the lit indicator.

4 Emergency eject hole

If you cannot open the disc tray with the eject button, turn off your computer, and then insert a thin, elongated object into this hole to eject the disc tray manually.

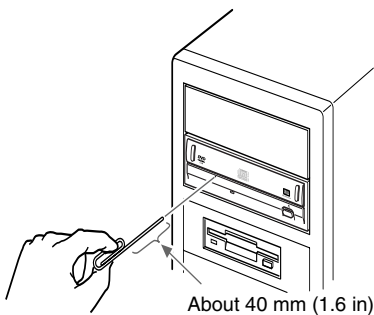
**5 Do not use.****6 Do not use.****7 Analog audio connector**

Analog stereo audio output. Using an audio cable, connect to the audio connector of a computer with a sound card.

Note

Connecting a cable other than an audio connector or otherwise misusing the audio connector may cause damage to the product.

8 Jumper

A jumper is set on the appropriate pins before connecting the drive.

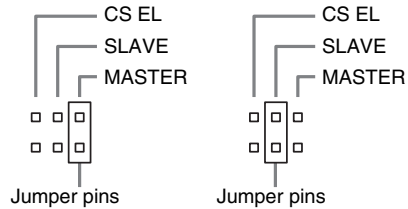
**9 IDE connector**

Connect to the computer with the supplied IDE flat cable.

10 Pin 1

The location of this pin determines the proper orientation of the connection cable.

11 Power connector

Connect the connector of the computer's internal power supply.

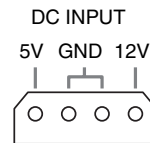

Setting up the Drive

The installation and setup procedures outlined below assume that you are using a standard computer. For details about how to install peripheral devices into your computer, refer to the instructions supplied with your computer.

Before installing the drive

Referring to “Unpacking the Package Contents” on page 6, verify that the contents of the drive package are complete.

Note

Avoid touching any exposed electronic conductors or contacts on the circuit boards of the drive or your computer, as they can be damaged by electrostatic discharges from your body. Make sure that you discharge any static electricity from your body before performing this operation.

- 1 Turn off your computer, disconnect the power cable from the outlet, and then remove the computer cover.

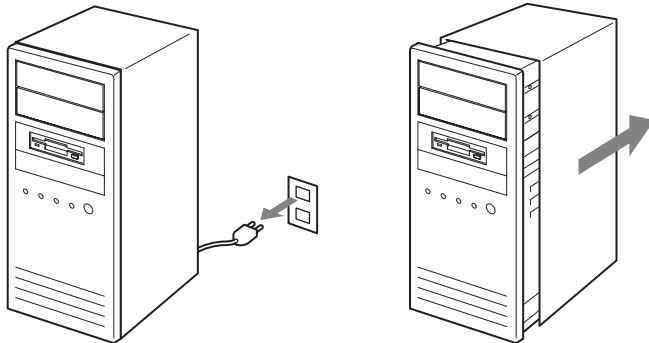

2 Determine which connection method you want to use, and then adjust the jumper.

Depending on whether you want to connect the drive as MASTER or SLAVE, place the jumper on the pins, as illustrated below.

If you are unsure of the appropriate jumper setting, see “Appropriate Jumper Settings” on page 15.

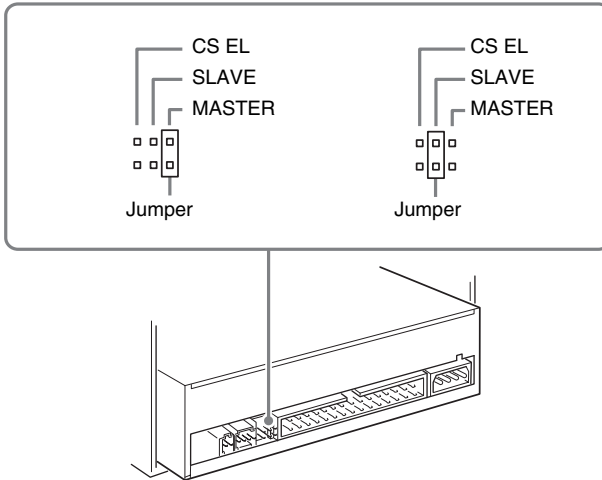

Notes

- If installing the drive to replace one using the CSEL jumper setting, place the jumper on the CSEL pins of the drive before installing it.
- Only place the jumper vertically, as illustrated. Placing the jumper horizontally may damage the drive and/or cause malfunctions.

3 Connect the cables.

- Connect an unused power connector from the computer's power supply to the DC input (power input) connector of the drive.
- Connect the supplied IDE flat cable to the IDE connector of the drive.

Hint

If your computer supports digital playback, you do not need to connect the audio cable to the analog audio connector. Most computers support digital playback at this time.

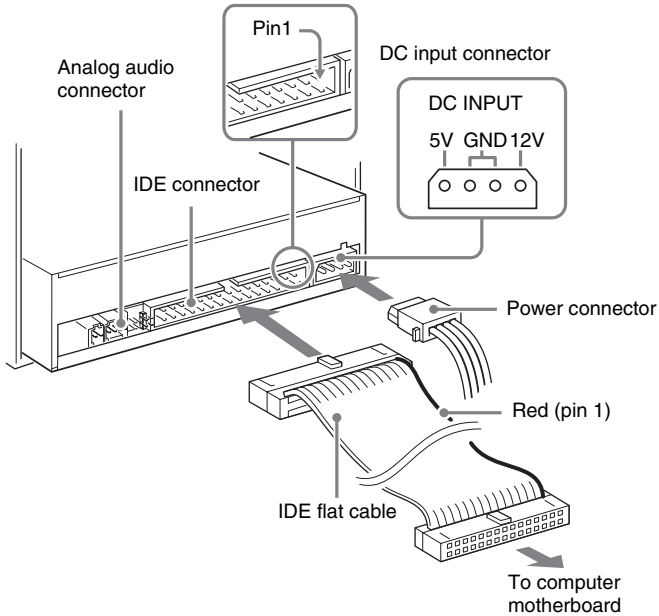

Notes

- The side of the IDE flat cable with the red line indicates the pin 1 conductor. Verify that the pin 1 side is connected to pin 1 on the motherboard.
- The power connector must be inserted with the inclined side upwards.
- If there is no spare power connector, you must use a “Y” adapter.

- 4** Install the drive into a 5-inch drive bay with the supplied screws.

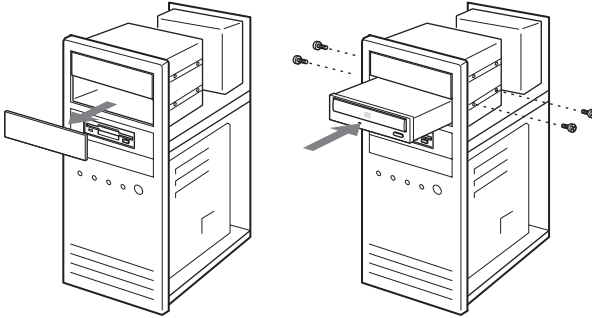

- 5** Replace the computer cover, and then reconnect the power cable to the outlet.

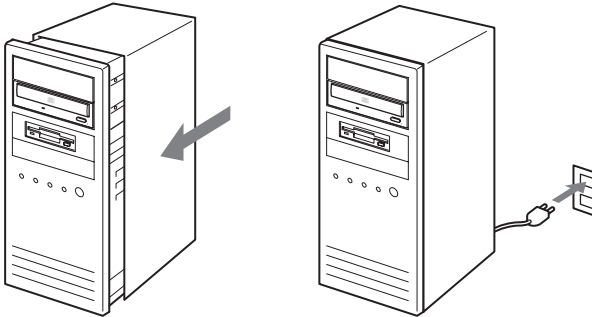

- 6** Start your computer, and make sure that the drive is detected. On the Windows desktop, open [My Computer], and verify that a new drive icon is displayed.

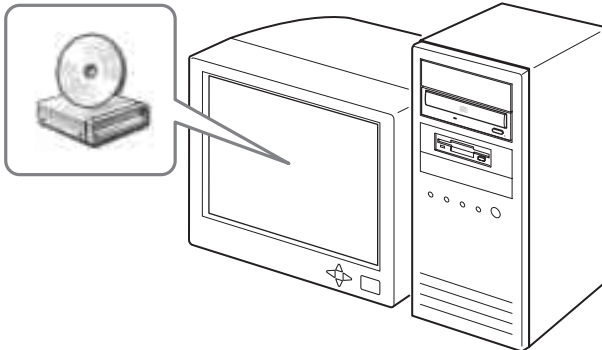

- 7 Insert the supplied software disc into the drive, and then install the software on the disc.

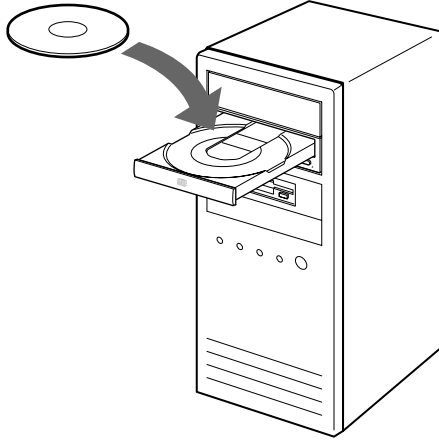

Follow the instructions on the screen to complete the installation.

For details about the software on the supplied software disc, see “Supplied Software” on page 19.

Hints

You do not need serial numbers when you install the software on the supplied software disc. However, in some instances you may have to purchase serial numbers or upgrade keys to upgrade the software.

Appropriate Jumper Settings

Depending on the settings of your computer, use one of the following configurations.

Hint

Your computer has two IDE connectors: a primary and a secondary connector. You can connect up to two devices to each connector using cables (one master device and one slave device per cable; hard disk, CD, or DVD drives, etc.). The hard disk of your computer is normally connected on the primary IDE cable as the master device. Before connecting the drive, refer to the items below to determine your situation, and then place the jumper in the MASTER or SLAVE position.

Replacing your current optical drive with the DVD/CD rewritable drive

Connect the drive as follows.

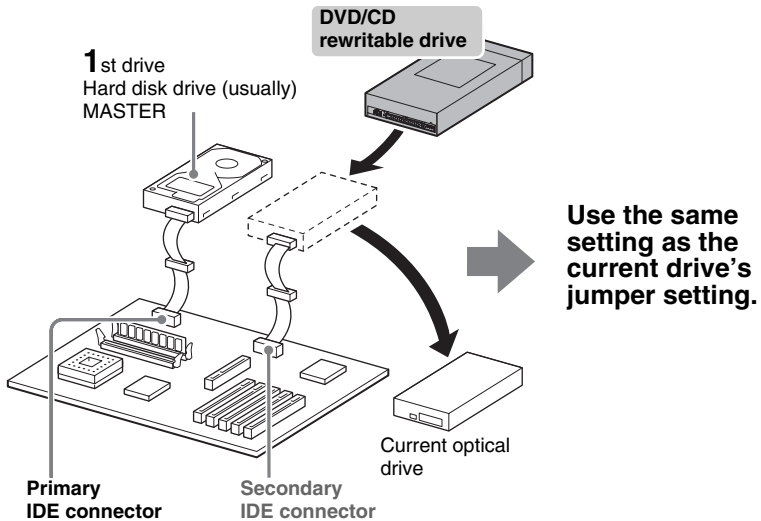

Installing the DVD/CD rewritable drive as a second drive

Connect the drive as follows.

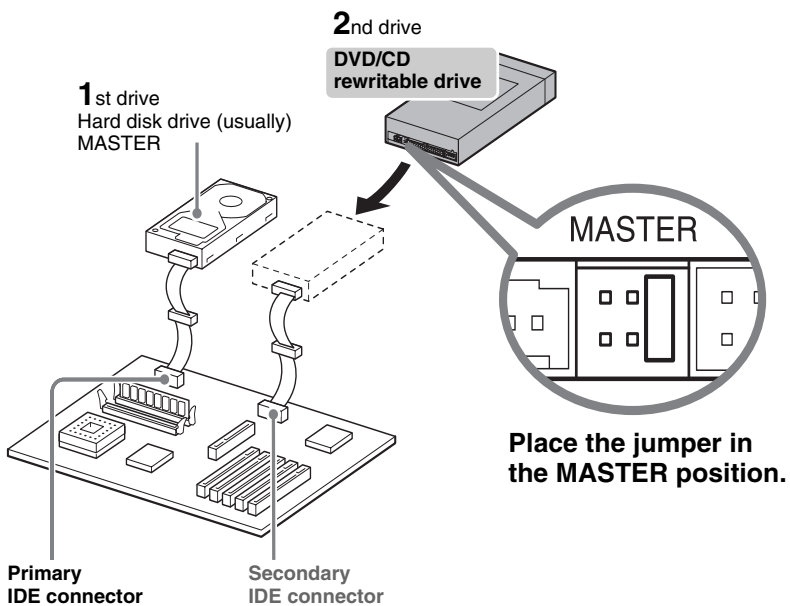

The following configuration is also possible.

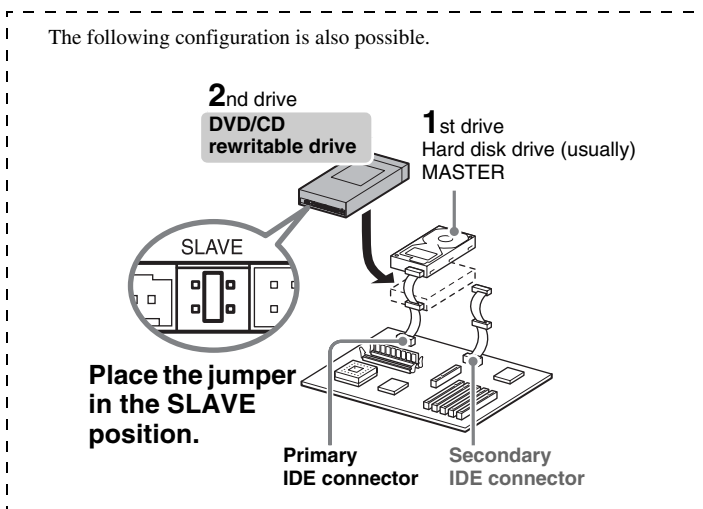

Installing the DVD/CD rewritable drive as a third drive

Connect the drive as follows.

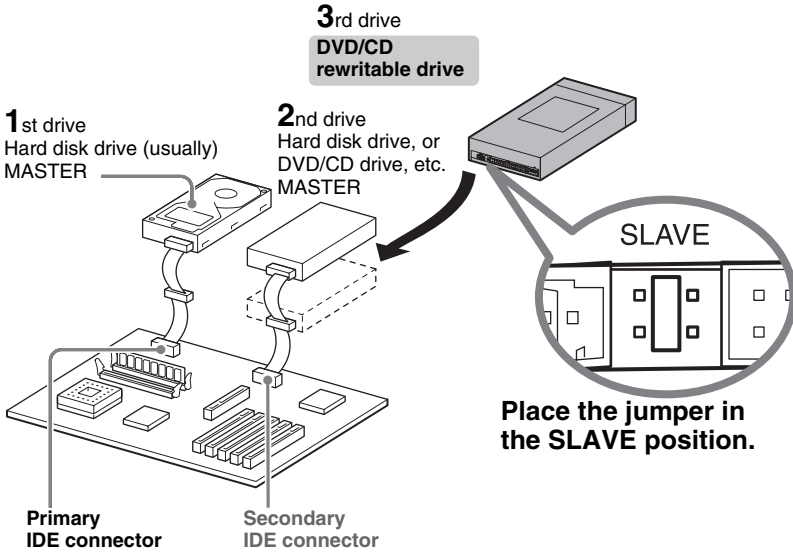

The following configuration is also possible.

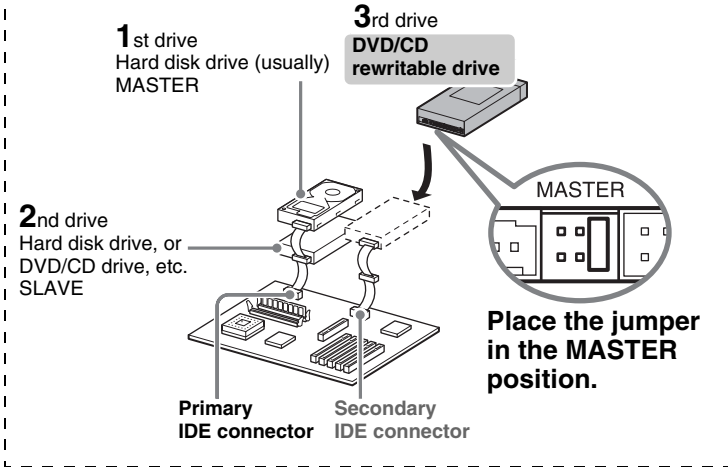

Installing the DVD/CD rewritable drive as a fourth drive

Connect the drive as follows.

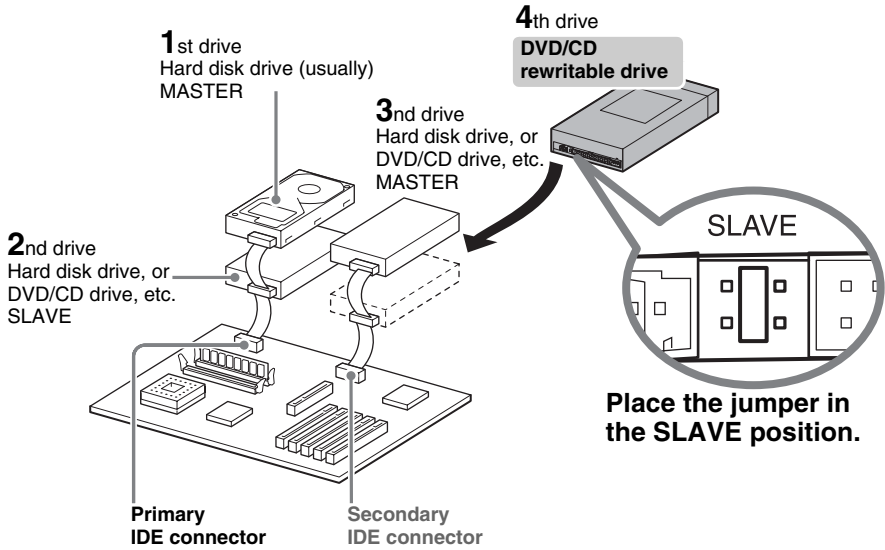

Using the Drive

Use the supplied software to create discs and play back DVDs. Refer to the documentation of each software for details about their operation.

Supplied Software

The supplied software disc contains the following software.

Nero StartSmart 2

Nero StartSmart serves as the command center to quickly start all the software of the Nero 6 suite.

Nero Burning ROM 6 SE

Nero Burning ROM is the CD and DVD writing software.

Nero Express

A light version of the Nero Burning ROM software. Makes it even easier job to create CDs and DVDs.

Nero BackItUp

Nero BackItUp is software that allows you to back up the data on your hard disk to the hard disk, DVD+R/RW, DVD-R/RW, or CD-R/RW discs.

InCD 4

InCD 4 is a packet writing software. It supports writing to DVD-RW, DVD+RW, and CD-RW.

NeroVision Express 3

DVD-Video and video CD authoring software.

Nero ShowTime 2

DVD-Video and video CD playback software.

Nero Recode 2

Nero Recode 2 is software for backing up the contents of a dual-layer DVD video on a single disc. It also allows you to convert DVD video and movie files into MPEG4-format files.

Nero Wave Editor 2

Audio processing software that allows you to modify and such audio files as WAV, MP3, and WMA.

Nero Cover Designer

CD and DVD cover and label creation software.

Nero Toolkit

The utilities of Nero Toolkit provide information about the system and more. Nero CD-DVD Speed tests the speed of the existing drives. Nero DriveSpeed adjusts the write speed to minimize drive noise. Nero InfoTool provides the main characteristics of drives, the discs they contain, and the installed software.

Using Generic Software with the Drive

Using software other than the supplied software (such as generic software, shareware, or freeware) to write data to disc with this drive is not under warranty and Sony offers no customer service if problems arise from using such software.

Make sure that the supplied writing software and generic writing software do not coexist on your computer. Taking appropriate steps to avoid this situation, especially in the case of packet writing software¹⁾ will help prevent erratic operation of the software and/or computer.









If the generic software you are using does not detect the drive correctly, visit the Web site of the software manufacturer and update the software, as this may solve the problem.

¹⁾ Such as Roxio's Drag-to-Disc, BHA's B's CLIP, and Sonic's DLA.

Compatible Discs

The following discs are compatible with the drive.









DVD

| Disc types | Logo | Read | Write | Write speed ¹⁾ |
|-------------------------|---|------|-------|--|
| DVD+R |  | ✓ | ✓ | Speed supported by the disc (max. 16×) |
| DVD+R DL (Double Layer) |  | ✓ | ✓ | Speed supported by the disc (max. 4×) |
| DVD+RW |  | ✓ | ✓ | Speed supported by the disc (max. 4×) |
| DVD+RW (High Speed) |  | ✓ | ✓ | Speed supported by the disc (max. 8×) |
| DVD-R |  | ✓ | ✓ | Speed supported by the disc (max. 16×) |
| DVD-RW |  | ✓ | ✓ | Speed supported by the disc (max. 6×) |
| DVD-ROM |  | ✓ | — | — |
| DVD-Video |  | ✓ | — | — |

¹⁾ Writing speed supported by the drive. Depending on your software and media, this speed may vary.

For more details on writing speed by disc type, access the user support web site (see page 33).

CD

| Disc types | Logo | Read | Write | Write speed ¹⁾ |
|---------------------|---|------|-------|--|
| CD-R |  | ✓ | ✓ | Speed supported by the disc (max. 48×) |
| CD-RW |  | ✓ | ✓ | Speed supported by the disc (max. 4×) |
| CD-RW (High Speed) |  | ✓ | ✓ | Speed supported by the disc (max. 10×) |
| CD-RW (Ultra Speed) |  | ✓ | ✓ | Speed supported by the disc (max. 24×) |
| CD-ROM |  | ✓ | — | — |
| CD-DA (audio only) |  | ✓ | — | — |
| CD Extra |  | ✓ | — | — |
| Video CD |  | ✓ | — | — |
| CD TEXT |  | ✓ | — | — |

¹⁾ Writing speed supported by the drive. Depending on your software and media, this speed may vary.

For more details on writing speed by disc type, access the user support web site (see page 33).

| Disc diameters | | Read | Write |
|----------------|-------|------|-------|
| DVD | 12 cm | ✓ | ✓ |
| | 8 cm | ✓ | — |
| CD | 12 cm | ✓ | ✓ |
| | 8 cm | ✓ | ✓ |

Notes

- Only round discs should be used with this drive. Attempting to read odd-shaped discs (stars, hearts, card shape, etc.) may damage the drive.
- Operation is not guaranteed when writing to or playing back 99 minute discs
- With 8 cm discs, you must place the drive horizontally.

Recommended Writable Discs

We recommend that you only use discs for which operation has been guaranteed. You can obtain the latest list of writable discs for which operation with this drive has been guaranteed at the user support Web site address (see page 33 for details).

User support Web site

Insert the supplied software disc into the drive, and in the [Menu Selection] screen, click [User Support Web Page]. You can also directly type the user support Web site address (see page 33 for details) in the address box of your Web browser.

Note

You can safely use most disc formats that comply to the appropriate standards with this drive. However, bear in mind that some generic discs do not comply to quality or performance standards necessary for safe use with this drive. If you use such discs, the drive may automatically adjust the writing speed, writing errors may occur, and discs that have been written to may generate reading errors, etc.

Writable Disc Features

You can use a variety of discs with the drive to write data. Refer to the table below to find the type of disc that matches what you want to do.

| | DVD+R DVD+R DL | DVD+RW | DVD-R | DVD-RW | CD-R | CD-RW |
|---|-------------------|--------|-------|--------|------|-------|
| Want to create DVD-Video that can be played back by most drives and/or players | ✓ | | ✓ | | | |
| Want to create DVDs that you can modify | | ✓ | | ✓ | | |
| Want to create DVDs to which you can add to later. | | ✓ | | | | |
| Want to create video CDs that can be played back with most computers | | | | | ✓ | |
| Want to use DVDs as you would video tapes (allowing multiple rewrites) | | ✓ | | ✓ | | |
| Want to share 700 MB of data or more (Want to create DVD-ROM discs) | ✓ | | ✓ | | | |
| Want to share data that can be used on most computers (Want to create CD-ROM discs) | | | | | ✓ | |
| Want to create audio CDs that be played back by most CD players | | | | | ✓ | |
| Want to back up your hard disk | | ✓ | | ✓ | | |
| Want to store data without deleting it | ✓ | | ✓ | | ✓ | |
| Want to use discs as floppy disks | | ✓ | | ✓ | | ✓ |

Note

You can access/play back the data written to the discs above with most drives/players that support their formats. However, some combinations of drives/players and discs (depending on their quality and/or characteristics) may make access/playback impossible. For details, refer to your drive/player documentation.

CD-R and CD-RW Discs

The DVD/CD RW drive can write to CD-R and CD-RW discs, when used with writing software. The ability of another model of CD-ROM drive to play (or read data) written by the DVD/CD RW drive depends on having the appropriate software settings when writing to the disc.

CD-R Discs

Data can be written to this type of disc only once, and once it has been written, it cannot be erased. Music CDs created on CD-R disc media can be played in a common CD player.

CD-RW Discs

Data can be written to and erased from this type of disc repeatedly. Typically, a new CD-RW disc can be rewritten about 1,000 times.

Music CDs created on CD-RW disc media cannot be played in a CD player unless it is specifically designed to be CD-RW compatible.

High Speed CD-RW Discs

The drive can write to High Speed CD-RW disc media. Data written on High Speed CD-RW discs can be read by common CD-ROM drives other than the drive.

Note

Drives that do not have the High Speed CD-RW logo cannot be used to write to High Speed CD-RW discs. When writing or appending to such discs with a drive other than this one, be sure that the drive has the High Speed CD-RW logo. Also, always set the writing speed to that specified for the particular High Speed CD-RW disc media being used.

Ultra Speed CD-RW Discs

The drive can write to High Speed CD-RW and Ultra Speed CD-RW disc media. Data written to these discs can be read by common CD-ROM drives other than the drive.

Note

Drives that do not have the Ultra Speed CD-RW logo cannot be used to write to Ultra Speed CD-RW discs. When writing or appending to such discs with a drive other than this one, be sure that the drive has the Ultra Speed CD-RW logo. Also, always set the writing speed to that specified for the particular Ultra Speed CD-RW disc media being used.

Writing Speed

When writing to CD-R and CD-RW discs, set the writing speed specified on the disc. Changing the writing speed is done through the writing software.

Reading Discs

CD-R and CD-RW discs created with the DVD/CD RW drive can be read on most CD-ROM drives. However, some older CD-ROM drives cannot read CD-RW discs.

Also, CD-R music discs created and finalized with the DVD/CD RW drive can be played in most CD players, but playback cannot be guaranteed for all CD players or automobile CD players.

Also, depending on the particular drive-disc combination, some CD-R and CD-RW discs may not be readable in some drives due to variations in disc quality and drive characteristics from one manufacturer to another.

Writable DVD Discs

The DVD/CD RW drive can write to DVD+R DL, DVD+R and DVD-R discs, as well as to DVD+RW and DVD-RW discs, when used with writing software. The playback (read) compatibility with DVD-ROM drives or DVD players of data written by this DVD/CD RW drive depends on the capabilities of the DVD-ROM drives or the DVD players and on the logical format selected when the disc is recorded (written).

DVD+R DL/DVD+R/DVD-R Discs

Data can be written to this type of disc only once. Once it has been written, it cannot be erased. Playback (read) compatibility of DVD+R and DVD-R discs with DVD-ROM drives or DVD players depends on the capability of the DVD-ROM drive and the DVD player and on the logical format selected when it is recorded (written).

DVD+RW and DVD-RW Discs

Data can be repeatedly written to or erased from this type of disc. Typically, a new DVD+RW or DVD-RW disc can be rewritten about 1,000 times. Playback (read) compatibility of DVD+RW and DVD-RW discs with DVD-ROM drives or DVD players depends on the capability of the DVD-ROM drive and the DVD player and on the logical format selected when it is recorded (written).

Disc Playback (Reading Data)

DVD+R DL/DVD+R/DVD-R discs, as well as DVD+RW and DVD-RW discs created and finalized with the DVD/CD RW drive can be played back on almost all DVD-ROM drives. However depending on the type of your drive, playback of DVD+R DL, DVD+RW, and DVD-RW discs may not be supported.

In addition, some drives do not support multi-session (DVD+R DL/DVD+R/DVD+RW) or multi-border (DVD-R/DVD-RW). In these cases, you can only playback the disc in single-session (DVD+R DL/DVD+R/DVD+RW) or single-border (DVD-R/DVD-RW).

Also, DVD-Video discs created with the DVD/CD RW drive can be played back on many standard DVD players. However depending on the type of your player, playback of DVD+RW and DVD-RW discs may not be supported. Further, because of the differences in quality and characteristics between various DVD-ROM drive, DVD player, DVD+R DL disc, DVD+R disc, DVD+RW disc, DVD-R disc, and DVD-RW disc manufacturers, playback may not be possible depending on the combination. (Playback compatibility is not under warranty.)

Precautions when Writing Data to Disc

Write speed and compatible discs

- When writing data to disc at high speeds, you must use the appropriate type of disc.
- Configure the writing speed through your writing software. For details about the setting procedures, refer to your writing software documentation.
- When writing data to disc, the drive may adjust the writing speed to the quality of the disc in the drive. Depending on the transfer rate, there may also be limitations on writing speeds.

DVD region codes

The playback of DVD-Video (DVD discs) is protected and controlled by a region code setting. For the drive to play back DVD-Video, the region code on the DVD disc, the region code of the drive, and the region code of the DVD-Video software must all match.

With this drive, the region code can be set up to five times, including the initial assignment (RPC phase 2¹⁾ standard). After setting the region code five times, the setting becomes permanent and can no longer be changed. From this point on, you are only able to play back DVD-Video whose region code matches the one set the fifth time.

Do not attempt to make unauthorized changes to the region code. Any problems resulting from doing so are not covered by the warranty.

Hint

You can change the region code of the drive on its properties dialog box accessible from the Device Manager.

Precautions when playing back DVD-Video

DVD-Video disc playback conditions are sometimes determined by software manufacturers. Because the drive plays back discs as determined by software manufacturers, some drive functions may not always perform as expected. When playing back DVD-Video, refer to the documentation accompanying each disc.

DVD copy protection technology

Most DVD-Video discs on the market are protected against unauthorized copy. Attempting to copy protected discs violates copyright laws.

¹⁾ Region Playback Control (RPC) standard.

Copy controlled CDs

This product is designed to play back discs conforming to the compact disc (CD) standard. Audio CDs encoded with copyright protection technology are now marketed by various record companies. Be aware that some of these discs do not conform to the CD standard and you may not be able to play them back with the drive. When using the drive as an audio CD player, only use audio CDs with the following mark. Some of these discs are encoded in such a way as to prevent sampling and/or copy, while others can only be played back under certain conditions. For details, refer to the documentation of your audio CD.



Maximizing Performance

User Support Web Site

Make sure that you use High Speed discs for which this operation has been certified by Sony. For the latest information about these discs, visit the user support Web site. When using discs other than those mentioned above, the drive may limit writing speed to preserve a good reading quality.

Updating the Firmware

We recommend using the drive with the latest firmware as some problems encountered when using the drive can be solved simply by updating the drive firmware. Firmware updates are available on the user support Web site.

Hint

The firmware is the built-in software that makes the drive work. For details about the user support web site, see page 33.

Turbo Boost Function

The default read/write speed of this drive is 40× speed. With a single touch, you can activate the Turbo Boost function, to raise the read/write speed to 48× speed.

Note

- On rare occasions, some discs may not be able to tolerate 48× speed, causing them to break. We recommend that you do not use deeply scratched, brittle, or other discs that may break at 48× speed.
- The Turbo Boost function does not guarantee a 48× write speed. Depending on the condition of the disc you are using, the speed may be automatically lowered.
- The Turbo Boost function does not increase read/write speed with CD-RW discs.

1 Insert a disc into the drive.

The read/write speed when you insert a disc is normally 40× speed.

2 Press and hold the Eject button for five seconds.

The Busy indicator blinks twice and the read/write speed switches to 48× speed. (The Turbo Boost function is active.)

Hint

When you open the disc tray, the read/write speed reverts to its default of 40× speed.

► **Miscellaneous**

Precautions for Use

Operation and storage conditions

Avoid using or storing the drive in a hot or humid location, or where it might be subject to severe vibration or direct sunlight.

On transportation

- Please repack the drive in its original carton when shipping by itself.
- If the drive is to be shipped while installed in a PC, remove any disc beforehand.

Avoiding condensation problems

As much as possible, avoid sudden temperature changes. Do not attempt to use the drive immediately after moving it from a cold to a warm location, or raising the room temperature suddenly, as condensation may form within the drive. If the temperature changes suddenly while using the drive, stop using it but keep the power on for at least an hour.

Handling discs

- Handle discs only by the edges. Never touch the recording surface.

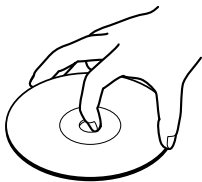

- Do not affix labels on discs.

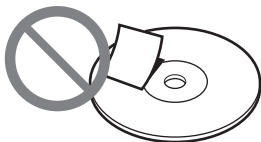

- Do not store discs in dusty, dirty or humid locations, in direct sunlight, or near heat-generating devices.
- To protect important data, always keep discs in their protective cases.
- Do not wipe writable discs to clean them before recording data. Instead, use a blower to remove any dust.
- Data may not record properly if a scratch or dust is present on the unrecorded area of writable discs. Use special care when handling.

Specifications

| Compatible discs | Read (max.) | Write (max.) |
|------------------------|-----------------------|-----------------------|
| DVD+R | 8X-CAV | 2.4X |
| DVD+R (4X) | 8X-CAV | 4X |
| DVD+R (8X) | 8X-CAV | 8X-P-CAV |
| DVD+R (16X) | 8X-CAV | 16X-CAV |
| DVD+R Double Layer | 6X-CAV | 2.4X |
| DVD+R Double Layer(4X) | 6X-CAV | 4X |
| DVD+RW | 8X-CAV | 2.4X |
| DVD+RW (4X) | 8X-CAV | 4X |
| DVD+RW (High Speed) | 8X-CAV | 8X-ZCLV |
| DVD-R | 8X-CAV | 1X |
| DVD-R (4X) | 8X-CAV | 4X |
| DVD-R (8X) | 8X-CAV | 8X-P-CAV |
| DVD-R (16X) | 8X-CAV | 16X-CAV |
| DVD-RW | 8X-CAV | 1X |
| DVD-RW (2X) | 8X-CAV | 2X |
| DVD-RW (4X) | 8X-CAV | 4X |
| DVD-RW (6X) | 8X-CAV | 6X |
| DVD-ROM | 16X-CAV | — |
| DVD-Video | 6X-CAV | — |
| CD-R | 48X-CAV ¹⁾ | 48X-CAV ¹⁾ |
| CD-RW | 32X-CAV | 4X |
| CD-RW (High Speed) | 32X-CAV | 10X |
| CD-RW (Ultra Speed) | 32X-CAV | 24X-ZCLV |
| CD-ROM | 48X-CAV ¹⁾ | — |
| CD-DA | 10X-CAV | — |
| CD-DA (DAE) | 48X-CAV ¹⁾ | — |

| Disc diameters | | | |
|----------------|--------------------|---|---|
| DVD | 12 cm | ✓ | ✓ |
| | 8 cm ²⁾ | ✓ | — |
| CD | 12 cm | ✓ | ✓ |
| | 8 cm ²⁾ | ✓ | ✓ |

1) The default setting is 40x. You must use the turbo boost function to achieve 48x speed.

2) With 8 cm discs, you must place the drive horizontally.

Writing systems

DVD

Random write
Sequential write

CD

Track-at-once
Disc-at-once
Session-at-once
Packet writing

Drive

Data transfer rate

DVD: 22.1 MB/s (16x speed¹⁾)
CD: 7.2 MB/s (48x speed¹⁾)

Access time

Average random stroke
Approx. 135 ms (DVD)
Approx. 140 ms (CD)

¹⁾ Maximum data transfer rate depends on the capabilities of the host computer.

Buffer underrun error protection

Power-Burn™
conformed

Operating environment

Operating temperature
5 to 40 °C

Power and miscellaneous

Power consumption

25.5 W

Power source

DC +5 V 1.5 A max.
DC +12 V 1.5 A max.

Size

Approx. 146 × 41.3 × 165 mm (W×H×D)
(excluding front panel)

Weight

Approx. 0.9 kg (drive only)

Laser

CD

Type: RLD78PZW3
Wavelength: 782 nm
Output power: 90 mW (CW)
240 mW (Pulse)

DVD

Type: ML101J25-23
Wavelength: 658 nm
Output power: 100 mW (CW)
255 mW (Pulse)

Interface**Drive interface**

ATAPI (EIDE) compliant

Buffer capacity

2 MB

Drive product number (Inquiry)

SONY DVD RW DRU-720A

Design and specifications are subject to change without notice.

Support Overview

If you have problems with the drive, or are unsure of a procedure or some other details, please contact your Sony customer support center.

User Support Web Site

You can find the following information on this Web site. The information is periodically updated, so we recommend that you visit regularly.

- Information about the drive
- Information about the software supplied with the drive
- Latest firmware
- Frequently asked questions
- Troubleshooting guide
- Certified compatible computers
- Certified compatible discs
- Operating instructions
- Et cetera

Accessing the user support Web site

Insert the supplied software disc into the drive, and in the [Menu Selection] screen, click [User Support Web Page]. You can also directly type the user support Web site address (see Product and Support Information for details) in the address box of your Web browser.

Update the Drive Firmware

Some problems encountered when using the drive can be solved simply by updating the drive firmware. Firmware updates are available on the user support Web site. Access the site, make sure that there is an update for your firmware, and follow the instructions on the screen to proceed with download and installation.

Product and Support Information

Sony Global Sites Information (As of November, 2004)

Product purchased in the USA:*
<http://sony.storagesupport.com/>

Product purchased in Canada:
<http://www.sony.ca/>

Product purchased in Australia or New Zealand:
<http://www.sony.com.au/>

Product purchased in Europe:*
<http://www.sonydigital-link.com/osd/>

Product purchased in Hong Kong:*
<http://www.sony.com.hk/Electronics/cp>

Product purchased in China:*
<http://www.sony.com.cn/ed/cp>

Product purchased in Singapore:
<http://www.sony.com.sg/asianit/>

Product purchased in Taiwan:*
<http://www.sony.com.tw/stwn/cpd/index.htm>

Product purchased in Korea:*
<http://www.sony.co.kr/cp>

Product purchased in Brazil:
<http://www.sony.com.br>

Product purchased in the Middle East:
<http://www.sony-mea.com/>

* Local Web sites for computer peripheral products

About the Bundled Software

Detailed information about the supplied software is available on the Web sites of the software manufacturer.

<http://www.nero.com>

Technical Support

Please consult the above sources before calling with questions about using this product, or with technical questions about the drive or the supplied software. If using telephone or e-mail support, please have the following information available:

- Model number: DRU-720A
- Serial number
- Date and place of purchase
- Computer maker and model number
- Computer specifications (CPU speed, memory size, OS version, etc.)
- Writing software used (version, etc.)

Local technical support is only available in the specified sales regions. The customers in these regions should be provided with a warranty card for this product. For contact information, refer to the warranty card.

Note that technical support conditions may vary according to the locality, and that charges and/or limited service may apply in some regions.

<http://www.sony.net/>

Sony Corporation Printed in China