

# **COLOUR TELEVISIONS**

**NICAM STEREO**  
**24", 25", 26", 28", 29", 32", 33"**

**Operating Instructions**

# List of contents

<b>Special features</b> .....	<b>2</b>
<b>Safety instructions</b> .....	<b>3</b>
<b>Getting started</b> .....	<b>4</b>
Aerial connection .....	4
Switching on .....	4
Battery fitting .....	4
<b>Control unit</b> .....	<b>5</b>
Front and rear panel.....	5
External connections table .....	6
Remote control .....	6
<b>Using the TV</b> .....	<b>7</b>
TV controls .....	7
Manual tuning.....	8
Automatic tuning .....	9
Child lock.....	9
Program table .....	10
<b>TV setup</b> .....	<b>11</b>
Sound menu .....	11-12
Picture menu .....	13
Features menu .....	14
Picture format.....	15
PIP Operation .....	16
<b>Using teletext</b> .....	<b>17-18</b>
<b>Connecting external equipment</b> .....	<b>19-23</b>
<b>Help and service tips</b> .....	<b>24</b>
<b>Technical specifications table</b> .....	<b>25</b>

# Television

Thank you for buying this television which is designed to give you many years of satisfactory service.

You may already be familiar with using a television but do please take time to read these instructions. They are designed to familiarise you with the unit's many new features and to ensure you get the very best out of your purchase.

## Special features

- Your TV can receive stereo channels directly (NICAM optional).
- Automatic tuning system with country selection.
- 100 Programme Memory
- Available for Cable Channels (A decoder maybe required)
- Manual Fine Tuning
- Child Lock
- Return to the last channel viewed (SWAP)
- Spatial Sound effect
- 16:9 picture format
- S-Video connection (optional)
- Audio/Video RCA sockets (optional).
- Back Audio Out (optional)
- Normalisation system to recall the setting in memory after the colour,contrast, brightness setting have been changed.
- Picture adjustment using one button (Smart control).
- Sound adjustment using one button (Smart control).
- Equalizer Sound Setup
- Automatic Volume Limiting
- Your TV set is equipped with an On-Screen Display system. This system enables the user to see the function on-screen and to control them efficiently.
- Infrared Remote Control
- Virtual Dolby Surround (optional)
- Multi language menu system
- On Timer
- Off Timer
- Stereo headphone socket (optional)
- 2 Scart Socket: Video cassette recorder, satellite receiver, video disc player,DVD, TV games or a home computer can be connected to this AV socket with an appropriate connecting cable.
- Third scart socket (optional).
- Subwoofer (optional)
- Zoom, Letterbox, Subtitle, Panaroma (optional), picture formats ( for Widescreen TV sets)
- Naming the channels
- Teletext reception
- Auto recognition of the broadcasting format (4:3, 16-9 or Letterbox) via WSS feature.
- Digital Colour Transition Improvement (DCTI).
- Digital Comb Filter (DCF).
- Digital Luminance Transition Improvement (DLTI).
- Dynamic Digital Video Adaption(Optional).
- TILT function (Optional).
- Dynamic Focus (Optional).
- Picture freeze function (Optional).
- PIP (2 tuner), (Optional).
- Mosaic Picture (optional)
- Picture and Text (optional)
- Picture on Picture (optional)
- Blueback
- Component input via Scart (optional)
- Component input via cinch (optional)

# Safety is Important

Your safety and the safety of others is important. Please, therefore, ensure you read the Safety instructions **before** you operate this television.

## Safety instructions

**!** Read all the safety instructions before first use of your TV.



- Position the television so that direct light does not fall on the screen. Excessive light will cause a washed out effect.



- Position the power supply lead and other leads so that they are not likely to be walked on or pinched by things placed on or against them.



- Do not use the appliance in humid or damp conditions. Do not allow the appliance to get wet, i.e. dripping or splashing, as this may be dangerous. Do not place water filled objects, such as vases and flower top on top of the appliance.



- Make sure that no naked flame sources, such as lighted candles, are placed on top of the appliance.
- Do not place the television near heat sources such as radiators, ovens, stoves, etc.



- Do not use the television near any apparatus that produces a magnetic field such as HI-FI speakers or electric motors otherwise colourpurity may be affected.



- The heat built up in the set escapes through ventilation holes, so do not cover the set by drapes, clothes etc. that may block air circulation. Do not place the television on carpet or soft furnishings.
- NEVER let children push anything into the holes or slots on the case.



- Clean the TV Screen using a slightly damp cloth or chamois leather. Never use abrasive cleaning agents like liquid or aerosol cleaners.
- Remove the mains plug from the socket outlet while cleaning.



- If you wish to place the television on a shelf or in a wall unit always ensure there is a minimum air gap of 8 cm around the top, sides and rear of the television, to assist ventilation.



- Your TV set is designed to operate with mains voltages 230V AC; 50Hz. Do not connect your TV set to power sources other than the mains supply.

# Getting started

Remove your Television carefully from the box. You may wish to store the packaging for future use.

## In the box

Inside your this package you should have:

- Television
- Remote control
- User guide
- AAA batteries x 2

4

**Read these instructions before use.**

## Aerial connection

To connect an aerial, plug the aerial lead into the aerial socket on the rear of the TV.

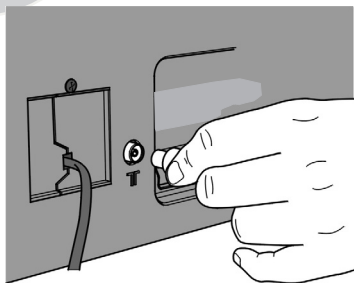

You can use an outdoor or indoor aerial. However, if you use an indoor aerial the quality of the reception may be reduced and adjustment of the aerial may be required when changing programs.

### Please note

If you live in a poor reception area or use an indoor aerial you may experience loss or corruption of teletext transmissions.

## Switching on

### Mains power

Connect the mains plug into the mains socket and switch on.

Connect the TV mains plug into your domestic mains socket outlet (230 V 50 Hz AC).

### Please Note

When not in use disconnect the plug from the mains power supply.



Press the **Power** button on the front of the TV. The standby indicator will illuminate.

Press a **Numeric** button or the **Program up** or **Program down** button on the remote handset or **Program up** or **Program down** button on the front panel to switch the TV on.

The standby indicator remains on. The picture will appear after a few seconds.



Press the **Standby** button to switch the TV to standby. The standby indicator will brighter.



**Blue Back:** When there is no broadcast, you can select the background purely blue instead of snowy picture.

### Please Note

Do not leave the television on standby unattended or overnight.

### Switching the TV on for the first time

To install your TV, please read the sections “TV controls” and “Tuning the television”.

## Battery fitting

Insert the 2 AAA Batteries supplied into the compartment on the rear of the remote control, ensure you follow the polarity diagram inside the compartment.

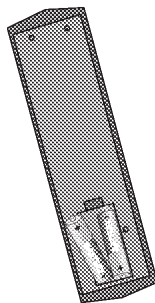

# Control Unit

## Front Panel

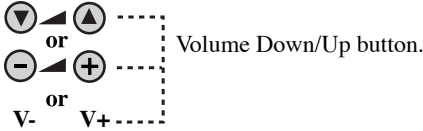
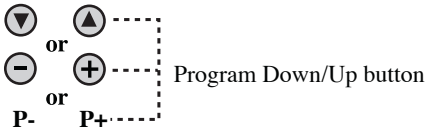

## General

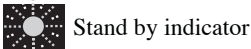

## External Connections: (Front or side) (External connections: (Rear)



Right audio RCA (Red)

Left audio RCA/Mono RCA (White)

Video RCA (Yellow)

S-Video connection

Headphone socket



AV1 scart



AV2 scart



AV3 scart (optional)



Aerial socket



Power cable

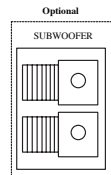

It is used for external subwoofer in 33" televisions

You may wish to connect audio amplifier or any similar devices to audio out. The output is always the current channel you are watching.

### Please note

- See the external connections table on next page for available connections depending the size and model of your TV set.
- Do not use Video RCA and S-Video connections at the same time, otherwise they will effect the picture each other.

# External connections table

Picture tube size/type	24" 16:9	25" 4:3	26" 16:9	28" 4:3	28" 16:9	29" 4:3	32" 16:9	33" 4:3
AV1 Scart	STD.	STD.	STD.	STD.	STD.	STD.	STD.	STD.
AV2 Scart	STD.	STD.	STD.	STD.	STD.	STD.	STD.	STD.
AV3 Scart	OPT.	OPT.	OPT.	OPT.	OPT.	OPT.	OPT.	OPT.
Headphone socket	OPT.	OPT.	OPT.	OPT.	OPT.	OPT.	OPT.	OPT.
Audio/Video RCA	OPT.	OPT.	OPT.	OPT.	OPT.	OPT.	OPT.	OPT.
S-Video socket	OPT.	OPT.	OPT.	OPT.	OPT.	OPT.	OPT.	OPT.
Back Audio Out	OPT.	OPT.	OPT.	OPT.	OPT.	OPT.	OPT.	OPT.

STD : Standart  
 OPT : Optional

**Please note:**

The Audio/Video RCA, S-Video and Headphone socket can be placed on the front panel or on the right-hand side of the cabinet depending to the model of your TV.

## Remote control

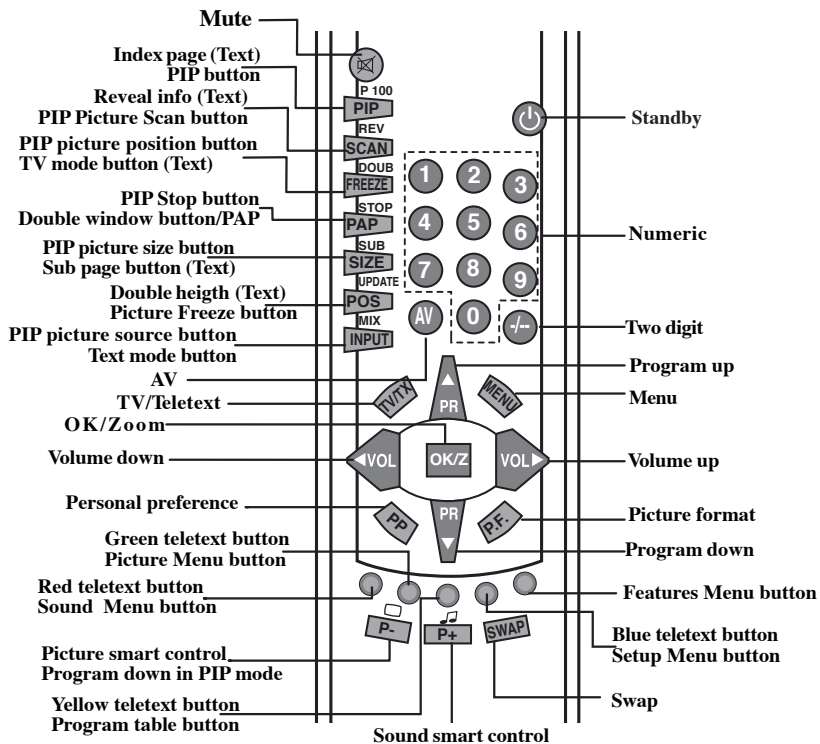

# Using the TV

## Turning on for the first time and Tuning



When you first turn your TV on, “**Language**” menu will appear. To search on the languages, use the **Program up** or **Program down**. **Volume up** or **Volume down** buttons and choose your desired language and press “**OK/Z**” button.

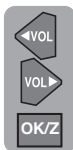

Then “**Country Selection**” menu will appear. Choose your country using **Program up** or **Program down**. **Volume up** or **Volume down** and press “**OK/Z**” button. “Autoprogram” process will begin and all the channels will be searched and stored.

## TV controls

### Programme selection



Press the **Program up** or **Program down** buttons on the TV or remote control or press a **Numeric** button to select a programme.

1

To select a programme whose number is greater than 9 using the numeric buttons, press the **-/--** button first and then press the two **Numeric** buttons. For example, to select programme 12, press the **-/--** button followed by **1** and then **2**.



1

2

You can also select a program by pressing in the OK button.



Press the **OK/Z** button and a grey box will appear on the screen with programme numbers on it.

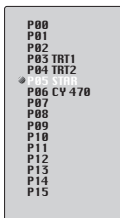

Use the **Program up** and **Program down** buttons to scroll through the programme numbers. When you find the program number you want press the **OK/Z** button again.

Press the **TV/TX** button to close the grey box.

### Volume

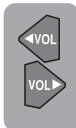

Press the **Volume +** or **Volume -** button on the TV or the **Vol ◀** or **Vol ▶** button on the remote control. A sound level bar will appear on the screen.

### Mute



To mute the sound press the **Mute** button on the remote control. A loudspeaker symbol will appear on the screen.



Press the **Mute** button again to restore the sound. The symbol will disappear.



Pressing **Volume down** buttons to decrease headphone volume. Pressing the **Volume up** buttons to increase the headphone volume.

### PP



Personal preference. Press the **PP** button to revert to the default settings for the TV. (See TV setup).

### Swap



Allows you to swap between the program you are watching and the last selected program. i.e. If you were watching Program 1 and change to Program 11, press the **Swap** button to go back to Program 1. Press it again to return to Program 11.

**PR 01** ➔ **SWAP** **PR 11** ➔ **SWAP** **PR 01**

### AV

For use when you are connecting an external source to your TV (Video recorder, DVD player etc.) via the SCART sockets or RCA sockets.

See ‘Connecting external equipment’.



Press the **AV** button to select your input as follows:

### 2 Scart models:

- 1 AV1 when using SCART socket 1.
- 2 AV2 when using SCART socket 2.
- 3 AV2S for S-Video equipment.
- 4 AV3 when using the RCA sockets of the TV. (Optional)
- 5 AV3S when using the S-video socket and RCA audio sockets of the TV. (Optional)

### 3 Scart models:

- 1 AV1 when using SCART socket 1.
- 2 AV2 when using SCART socket 2.
- 3 AV2S for S-Video equipment.
- 4 AV3 when using SCART socket 3.
- 5 AV4 when using the RCA sockets of the TV. (Optional)
- 6 AV4S when using the S-video socket and RCA audio sockets of the TV. (Optional)





Press the **AV** button again to return to TV.

## Tuning the television

There are two ways of tuning your television: Manual, where you control the tuning process or

Autoprogram where the television does it all automatically.

### Please Note

If the TV is set to a channel with no signal the TV will return to standby after 5 minutes.

The time remaining is displayed on the screen last 60 second.

### Manual tuning

Tuning the TV is accessed through the **SETUP** menu.

There are two ways to access the **SETUP** menu:

Press the blue **Setup** button.  
or  
Press the **Menu** button and use the **Program down** button to select **SETUP**. Press the **OK/Z** button to enter the **SETUP** menu.

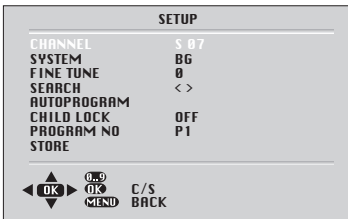

### Please note

The system will displayed automatically on **SYSTEM** row i.e.BG, L, I, DK depending the receiving broadcasting system of the country. In some countries the broadcasting system can be both in BG/DK or BG/LL'. Only the TV sets produced with Pal Secam BG/DK or Pal Secam BG/LL' systems can receive both BG/DK or BG/LL' broadcasts. In this case the user can select the required **SYSTEM** using **Volume up/down** buttons.

### Please note

If you do not press any buttons for 15 seconds the TV will exit the menu system.



In the Setup menu select **PROG NO** and change to **P1** using the **Program down** button to select it and the **Volume up** button to change it.



Starting with Program 1, tune in the first channel as follows:

Use the **Program down** button to select **SEARCH**.

Press the **Volume up** or **Volume down** button to start the tuning search.

When the search finds a strong channel signal it will stop searching. The picture will appear.

Identify which channel you are watching (BBC 1, ITV 1 etc.) and decide which program number you want it to be.



Use the **Program down** button to select **PROGRAM NO**.

Use the **Volume up/down** buttons to select the program number.

Use the **Program down** button to select **Store**. Press the **OK /Z** button and **STORED** will appear on the **STORE** line.

You have now stored the first channel.



Use the **Program up** button to select again **SEARCH** and continue the tuning procedure until you have tuned in all the programmes you want or the television can receive.

## Tuning with channel numbers

Enter the SETUP menu by pressing the blue button.



Press the **OK/Z** button to enter the CHANNEL row.



Use the **OK/Z** button to select "S" for cable channels and "C" for terrestrial broadcast.



Use **Volume up** button to select the channel number buttons.



Enter the channel number using the Numeric buttons.



Press the **Program down/up** buttons to exit the channel row.



Use the **Program down** button to select PROGRAM NO.



Use the **Volume up/down** buttons to select the program number.



Use the **Program down** button to select STORE. Press the **OK /Z** button and STORED will appear on the STORE line.



You have now stored the first channel.



Use the **Program up** button to select again SEARCH and continue the tuning procedure until you have tuned in all the programmes you want or the television can receive.





To exit the SETUP menu press the TV/TX button.

## Automatic tuning (Autoprogram)

Enter the SETUP menu as before.

SETUP	
CHANNEL	S 07
SYSTEM	BG
FINE TUNE	0
SEARCH	< >
AUTOPROGRAM	
CHILD LOCK	OFF
PROGRAM NO	P1
STORE	



Use the Program down button to select AUTOPROGRAM and press the **OK/Z** button. A list of countries will appear. Select the desired country using **Program** and **Volume** buttons.



When you are sure the aerial is connected properly press the **OK/Z** button. Autoprogram will start.



To cancel Autoprogram whilst it is working press the **Menu** button.

**Your TV is now tuned and ready to use.**

### Please note:

If auto sort fails to arrange the programmes in the required sequence please refer to programme table.

### Fine tuning

Although the search and Autoprogram will automatically try and tune to the best reception, in areas of poor reception a bit of fine tuning may be required.



In the SETUP menu use the Program up/down buttons to select FINE TUNE. Use the Volume up and Volume down buttons to fine tune.



When you have finished use the **Program down** button to select STORE and press the **OK/Z** button.



### Child lock

Childlock switches off the programme you are watching when you select it. All other programmes are unaffected. If you go back to the programme with childlock on you will see a black screen with the OSD showing "0-". You can lock as many programs as you want.



Press the **Volume up** button to switch the Child lock on or off.

# Program Table

Once you have tuned in all the channels you want, you can change their programme number, if required, and name them.

To enter the PROGRAM TABLE menu press the **Menu** button and select PROGRAM TABLE and press the **OK/Z** button or press directly the **Yellow** button.

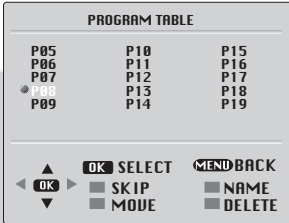

10

PROGRAM 01 will be selected and the channel stored under PROGRAM 01 will be showing on the screen.

The buttons used to edit the programs are shown at the bottom of the display:

- Blue button - Name
- Green button - Move
- Pink button - Delete
- Red button - Skip

## To name the programmes

Press the **Blue** button, the selected line will turn blue and the CH will turn white.

Use the **Program up** and **Program down** buttons to select the letters and numbers and the **Volume up** and **Volume down** buttons to move through the name.

Press the **Blue** button again to store the name.

Repeat this process to name all the programmes.

## Please Note

Some TV channels may send their names with teletext transmission. In this case their names will be automatically shown on the name line.

## To move the programmes

You can move the programmes around the programme list to the order you want

Select the programme you want to move and press the **Green** button. The programme will turn to green. Select the number you want to move the programme to and press the **Green** button again and the programme will be moved to that number.

All the following programmes are shifted down by one place.

## To delete a programme

To delete a programme, select it and press the **Pink** button. The programme will turn pink and the programme will be deleted.

All the following programmes are shifted up by one position.

## To skip programmes

Skipped programmes will not appear when you move through the program list using the **Program up/Program down** buttons.

They can still be selected using the numeric buttons or the OK button.

Select the programs you want to skip and press the **Red** button. The program will turn red. To unskip the program press the **Red** button again.

To exit the PROGRAM TABLE press the **TV/TX** button once, **Yellow** button or the **Menu** button twice.

When you select a programme, the information you entered in the PROGRAM TABLE menu will appear on the top of the screen i.e. P1 BBC1. This will disappear after about three seconds.

## TV set up

The TV set up is accessed through a menu system.

Once you have stored your set up, this is the set up the TV will default to when you switch it on.

To enter the MAIN menu press the **Menu** button.

Once in the MAIN menu use the **Program up** and **Program down** buttons to select items in the menu and the **OK/Z** to access sub menus or use the coloured fastext buttons for quick access.

- Red button - SOUND
- Green button - PICTURE
- Yellow button - PROGRAM TABLE
- Blue button - SETUP
- Pink button - FEATURES



### Please note

If you do not press any buttons for 15 seconds the TV will exit the menu system.

### Sound menu (red button)

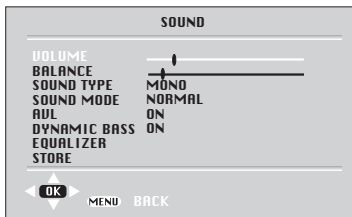

Select the required item in the menu using the **Program up/down** buttons and make the changes pressing **Volume up/down** buttons. Use the **OK/Z** button to enter EQUALIZER sub menu.

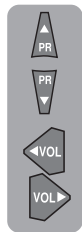

### Volume

Sets default volume using the **Volume up** and **down** buttons.



To save your settings, select **STORE** and press the **OK/Z** button. **STORED** will be displayed. Press the **Menu** button to go back to the previous menu.

### Balance



Sets the sound balance when the TV is in stereo mode using the **Volume up** and **down** buttons

To save your settings, select **STORE** and press the **OK/Z** button. **STORED** will be displayed. Press the **Menu** button to go back to the previous menu.

### Sound type

This item shows **STEREO** when receiving stereo transmission and **MONO** for mono transmissions.

The TV can be produced to receive the **NICAM** broadcasts as a optional feature.

If the channel you are watching is in **Nicam stereo** the **On Screen Display** will show **NICAM STEREO** for a while.

### Please Note

If, while watching a **nicam stereo** channel, the signal strength drops and the system cannot receive **nicam stereo** the **OSD** will show **MONO**. If the signal strength increases again and **nicam stereo** can be received again, the **OSD** will show **NICAM STEREO**.

## Sound mode

You can select NORMAL, SPATIAL or DOLBY VIRTUAL (optional) using the **Volume up/down** buttons or mix button.

SPATIAL sound is an 'expanded stereo'. It gives the impression that the two speakers in the TV are further apart than they really are.

DOLBY VIRTUAL is based on Dolby Pro Logic decoding for production of the Left, Right, Centre and Virtual Surround Sound channels using two loudspeakers.

**Manufactured under license from Dolby Laboratories. "Dolby", "Pro Logic" and the double-D symbol are trademarks of Dolby Laboratories.**

### Please Note

To get the surround effects in Dolby Virtual mode, you must apply a Dolby Surround encoded input to the TV.

You can't adjust the AVL and EQUALIZER in DOLBY VIRTUAL mode.



To save your settings, select STORE and press the **OK/Z** button. STORED will be displayed. Press the **Menu** button to go back to the previous menu.



## AVL

TV transmitters have different sound levels. AVL (automatic volume limiting) maintains the same sound level as you switch from program to program.

To supply this press **Volume up** or **down** button and select **ON** for AVL.



To save your settings, select STORE and press the **OK/Z** button. STORED will be displayed. Press the **Menu** button to go back to the previous menu.



## Dynamic Bass (optional)

Set DYNAMIC BASS to ON if you wish to deepen the bass sound specifically.

## Subwoofer (optional)

A sub woofer speaker can be fitted within the TV case as an option depending to the model.

For 33"(84cm) TV sets there is an external subwoofer (optional) to be fixed as shown below.

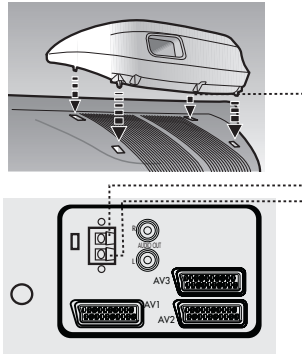

Select Sound menu and press **Program down** button to access subwoofer.



Press the **Volume up** button to switch the Subwoofer on or off.

### Please Note





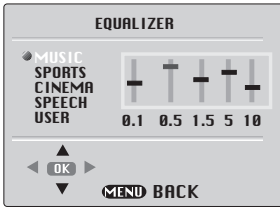

If you move the loudspeaker switch, on the rear of the TV, to the external position, the internal speakers in the TV will be switched off but the Subwoofer will remain on if switched on.

## Equalizer



In this menu are a series of preset equalizer settings for different types of sound output. There are five music settings - MUSIC, SPORTS, CINEMA, SPEECH and USER mode.

USER allows you to set your own sound output as follows:

-  Place the OK button to enter the use EQUALIZER menu.
-  Use the **Program down** button to select USER.
-  Press **OK/Z** button to adjust the frequency band levels.
-  Use the **Volume up** button to select the KHz column you want to change.
-  Use the **Program up/down** buttons to make the changes.
-  To save your settings, press the **OK/Z** button. Press the **Menu** button to go back to the previous menu.

You can change the equalizer setting whilst watching the TV using the sound Smart control.

-  Press the sound **Smart control** to page through the different equalizer settings and select the one you want.

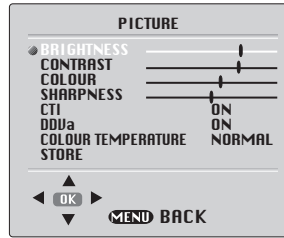

Once you have switched the TV off the equalizer setting will revert to the stored setting.

## Picture menu (Green button)



The picture menu allows you to set up the following:

- BRIGHTNESS
- CONTRAST
- COLOUR
- SHARPNESS
- CTI
- DDVa
- COLOUR TEMPERATURE

-  To change, for example, the colour, select it using **Program** buttons.
-  Use the **Volume up** and **Volume down** buttons to change the setting.
-  To save your settings, select STORE and press the **OK/Z** button. STORED will be displayed.

### CTI (Colour Transient Improvement):

You can improve the colour transitions in the picture by selecting ON or OFF.

### DDVa (OPTIONAL)

#### (Dynamic Digital Video Adaption):

You can increase the picture sharpness by selecting DDVa as ON.

### Smart cont.

This gives you a choice of picture type: SOFT, NATURAL, RICH or USER.

Use the  button to change this type.



Select **BRIGHTNESS**, **CONTRAST**, **COLOUR** and **SHARPNESS** using the **Program up/down** buttons.

Change the settings with the **Volume up/down** buttons.

To save your settings, select **STORE** and press the **OK/Z** button. **STORED** will be displayed. Press the **Menu** button to go back to the previous menu.

You can change the picture type whilst watching the TV using the picture **Smart control**.

Press the picture **Smart control** to page through the different picture types and select the one you want.

Once you have switched the TV off the picture type will revert to the stored setting.

**IMPORTANT NOTE:** Your TV has Digital Comb Filter, DLTI (Digital Luminance Transient Improvement) features to improve picture quality. These features are set ON and they can not be changed by the end user.

### Features Menu (Pink button)

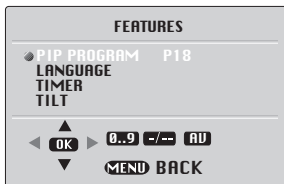

**PIP Program:** You can select the program to be displayed on the PIP sub-picture by pressing **Volume up** and **down** buttons or you can also press the numeric buttons to select the PIP program directly. To select AV input press the **AV** button repeatedly.

### Language

There are many languages available for the On Screen Displays (OSD).



Press the **OK/Z** button to select the language list.

Press the **Program down** button to page through all the languages and **OK/Z** to select.

**Timer:** Use **Program up** and **down** buttons to select **Timer** in the features menu. Using the Timer function, you can switch to a specific programme at a pre-programmed time or you can turn your TV off at the time you want your TV to be turned off.

Press **OK/Z** to access the **Timer** menu.

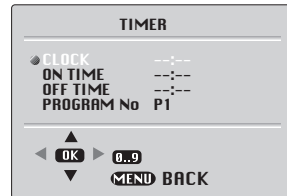

**Clock:** Use the numeric buttons to set the real time.

**On Time:** Use the numeric buttons to set the time that you want your TV to be turned on (TV should be on stand-by mode).

**Off Time:** Use the numeric buttons to set the time that you want your TV to be turned off (Stand-by mode).

**Program No:** Use the numeric buttons to set the programme number that will be shown when you set the **On Time**.

### Tilt (OPTIONAL):

Because of the structure of the picture tubes, your picture can be lost on the corners of the screen depending on the position of your TV, north-south-east-west.

To clear this effect, you can adjust the **TILT** setting and prevent the picture loss (OPTIONAL).

### Picture format

This allows you to select the picture size on corresponding to the screen type widescreen of your TV:

Available formats for widescreen TV sets are 16:9, 4:3, zoom, Letterbox, Subtitle and Panaroma.

Available formats of 4:3 TV sets are 4:3 and 16:9.

The formats of the broadcasts (4:3 or 16:9) you watch by means of aerial input are chosen automatically. (4:3, 16:9 and Letterbox for 16:9 TV) This feature is active if the channel you are watching sends WSS (Wide Screen Signalling) information.

Note: The feature mentioned above is relevant for TV sets having tele-text.

### Widescreen TV sets:

16:9, this is the screen format of widescreen TV sets (24" SF, 26" PF, 28" SF/PF, 32" SF/PF).

The TV will automatically switch to this format if it detects 16:9 format from the SCART inputs.

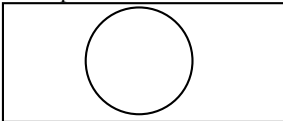

4:3, conventional TV picture format.

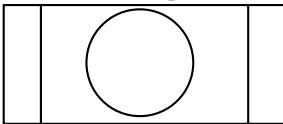

Zoom, an enlarged 4:3 format retaining the same aspect ratio.

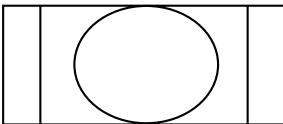

L Box (Letter box), Useful for watching video, some film formats and Pal-Plus format.

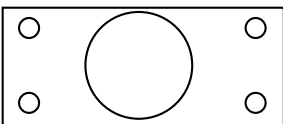

### 4:3 Sets:

4:3, is the screen format of 25", 28", 29" and 33" TV sets But you can change the picture format to 16:9 to able to watch the inputs in 16:9 format, i.e. some broadcasts and DVD's.

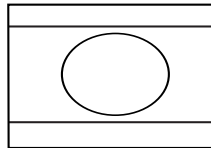
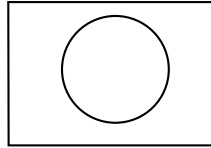

Press the **P.F.** button to page through the different picture formats and select the one you want. The selected format will appear on the lower center of the screen for a short while.

Once you have switched the TV off the picture format will revert to the stored setting.



**PIP OPERATION (OPTIONAL)**

2 Tuner PIP function allows you to watch 2 programmes or other inputs like DVD, VCR or satellite receiver at the same time through its PIP window.

It includes lots of functions like, SWAP, SIZE, POSITION, ZAPP and DOUBLE WINDOW.

**On and off**

Press the **PIP** button to switch on the PIP picture. Press again to switch it off.



**Input mode selection for PIP picture**

Press the **INPUT** button to select the AV input signal for the PIP picture.



**Swapping between main and PIP pictures**

Press the **SWAP** button to exchange the main and PIP pictures.

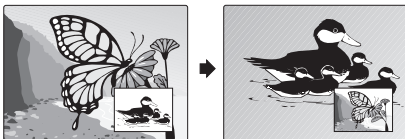

**ZAPP: Programme selection for PIP picture**

Press the **P-/P+** buttons. The selected sub-programme number is displayed just below the sub picture.



**PIP picture size**

Repeatedly press the **SIZE** button to select the desired PIP picture size.

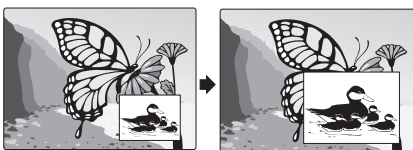

**DOUBLE WINDOW**



If you press the **PAP** button the double window function will be displayed by putting the PIP window on the half of the main picture.

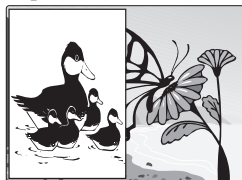

**PAT (Picture and Text) (OPTIONAL)**

In the double window function, you can also display the teletext screen in the second window.

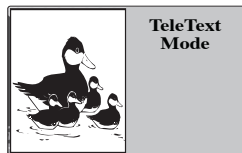

**PIP picture position change**

Press the **POS** button repeatedly until desired position is achieved. The PIP picture moves clockwise.

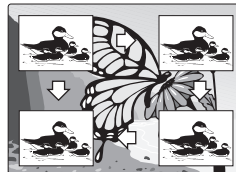

**Programme scan**

This function enables you to search all the stored stations in 11 PIP pictures mode only and see your favorite station by exchanging the main and PIP pictures by pressing **SWAP** button during **SCAN** mode.

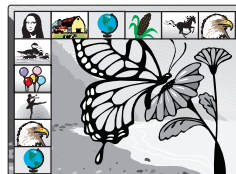

# Using Teletext

Teletext is an information system that displays text on your TV screen. Using the teletext control buttons you can view pages of information that are listed in the teletext index.

## Please Note

No on screen display is available in text mode. The contrast, brightness and colour cannot be changed but the volume control is still available.

## To enter Text mode

### Please Note

Make sure the TV channel you are watching transmits teletext.



Press the **TV/TX** button. The text page will appear, normally the index page.

## To exit Text mode



Press the **TV/TX** button. The TV will return to the channel you were watching.

## To select a page of text



Find the number of the page in the index and enter it using the **Numeric** buttons. The number of the page will appear in the top left hand corner of the screen.

The page counter will search for your page. When it finds it, the page will be displayed.



To move to the next page of text press the **Program up** button.



To move to the previous page press the **Program down** button.



To return to the index page press the **PIP** button.

## TV/text mix



To view a page of text whilst watching a TV programme press the **Mix** button. The text will be superimposed over the TV programme.



Press the **Mix** button again to return to the text page.

## Page search whilst watching TV



In Text mode press the Update button. The TV will return to TV mode with the text page number in the top left hand corner of the screen.



Enter the page number you want using the **Numeric** buttons.

The top line of the text page will appear whilst the text searches for your page. When the page is found the number will remain in the top left hand corner of the screen.



Press the **Update** button to view your selected page of text.

## Double height text



If you have difficulty reading the text on the TV you can double the height of the text.

Press the **Double** button. The top half of the page will be displayed in double height text.



Press the **Double** button again. The bottom half of the page will be displayed in double height text.



Press the **Double** button again to return to the full page.

### Page hold

If the page of text you have selected contains sub pages, these sub pages will automatically be displayed in order with a delay to allow you to read the page.



To stop the move to the next sub page press the **Stop** button. STOP will appear in the top left hand corner.



To continue moving through the sub pages press the **Stop** button again.

### To select a sub page

If the page of text you are viewing contains sub pages, the number of the sub page you are on and the total number of sub pages is displayed on the right of the screen i.e. 1/7.



To select a sub page press the **Sub** button. The number in the top left hand corner will be replaced by S followed by 4 asterisks.



Enter the number of the sub page, using the **Numeric** buttons in the format S0001 for sub page 1.

The teletext will search for the sub page. This may take some time. To return to the TV whilst the teletext is searching press the **Update** button.

When the page number is found it will appear in the top left hand corner of the screen.



Press the **Update** button again to view the text page.

### To reveal information



Press the **Rev** button to reveal concealed information (quiz answers etc.).



Press the **Rev** button again to conceal the information again.

### Clock



Press the **Sub** button, whilst watching a TV program, to display the time.

### Fastext

At the bottom of the teletext screen is a row of subject headings in red, green yellow and blue.

The remote control has a row of coloured buttons corresponding to the row of coloured subjects on the screen.

Pressing one of the coloured buttons will take you directly to the page corresponding to the subject heading.

### Toptext (optional)

At the bottom of the teletext screen is a row of subject headings in yellow and blue. Pressing yellow or blue buttons on the remote control, selects the related Subject. Next page can be selected by pressing the red button and previous page can be selected by pressing the green button.

**Note:** Fastext and Toptext features are not available in every program.

# Connecting external equipment

## Headphones (optional)

The headphones must have an impedance of between 8 and 32 ohms and have a 3.5 mm stereo jack plug.

Plug the headphone jack into the headphone socket of the TV.

## Connecting a video recorder

### ① Via SCART

Make sure the TV and video recorder are both switched off.

Plug one end of the SCART lead (not supplied) into the back of the video recorder and the other end into one of the SCART sockets on the back of the TV.

Switch on the video recorder and the TV.

AV

Press the **AV** button on the remote control to select AV1, AV2 or AV3 (optional) to correspond with SCART socket you are using on the back of the TV.

### Please note:

You can connect a RGB external equipment via Scart 1. It is necessary to you use full Scart cable for this purpose.

Select the video outputs of external device by using its menu to RGB if it's available.

### ② Via RCA lead (optional)

Make sure the TV and video recorder are both switched off.

Plug one end of the RCA lead into the video and audio out sockets on the back of the video recorder and plug the other end into the video and audio in sockets of the TV.

If the sound is in mono use the Audio Input L. In the SOUND menu select MONO.

AV

Press the **AV** button repetitively and select the AV3 mode by two scart models or select AV4 mode by three scart models.

### ③ Via aerial socket

Make sure the TV and video recorder are both switched off.

Unplug the aerial lead from the TV and plug it into the aerial socket on the video recorder (if fitted).

Plug a coaxial plug into the RF out socket on the rear of the video recorder and plug the other end into the aerial socket of the TV.

Switch on the video recorder and the TV.

If your video recorder has a test signal, switch it on. (Refer to the video recorder user guide).

See 'Tuning the TV' and carry out the tuning procedure for the video recorder test signal. Select a programme number 0 or between 55 and 99.

### ④ S-Video Player

If you have an S-Video player you can connect it to SCART socket 2 via an adaptor from scart to S-Video/RCA audio (not supplied).



Press the **AV** button three times to select AV2S (available by two scart models).

### ⑤ Via RCA lead and S-Video socket

You can also connect it through the S-Video socket of the TV (optional).

Plug the S-Video plug into the S-Video socket and the audio leads into the audio sockets.



Press the **AV** button repetitively to select AV3S by two scart models or AV4S by three scart models.

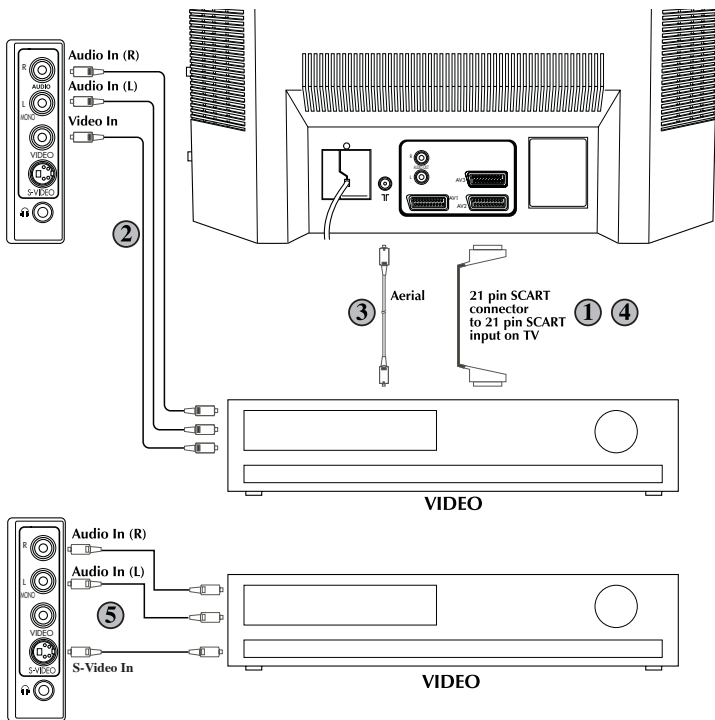

# Connecting a DVD player

## ① Via SCART

Make sure the TV and DVD player are both switched off.

Plug one end of the SCART lead (not supplied) into the back of the DVD player and the other end into one of the SCART sockets on the back of the TV.

Switch on the DVD and the TV.

**AV** Press the **AV** button on the remote control to select AV1, AV2 or AV3 (optional) to correspond with SCART socket you are using on the back of the TV.

## ② Via RCA lead (optional)

Make sure the TV and DVD player are both switched off.

Plug one end of the RCA lead into the video and audio out sockets on the back of the DVD player and plug the other end into the video and audio in sockets of the TV.

**AV** Press the **AV** button repetitively and select the AV3 mode by two scart models or select AV4 mode by three scart models.

## ③ Via RCA lead and S-Video socket

You can also connect it through the S-Video socket of the TV (optional).

Plug the S-Video plug into the S-Video socket and the audio leads into the audio sockets.

**AV** Press the **AV** button repetitively to select AV3S by two scart models or AV4S by three scart models.

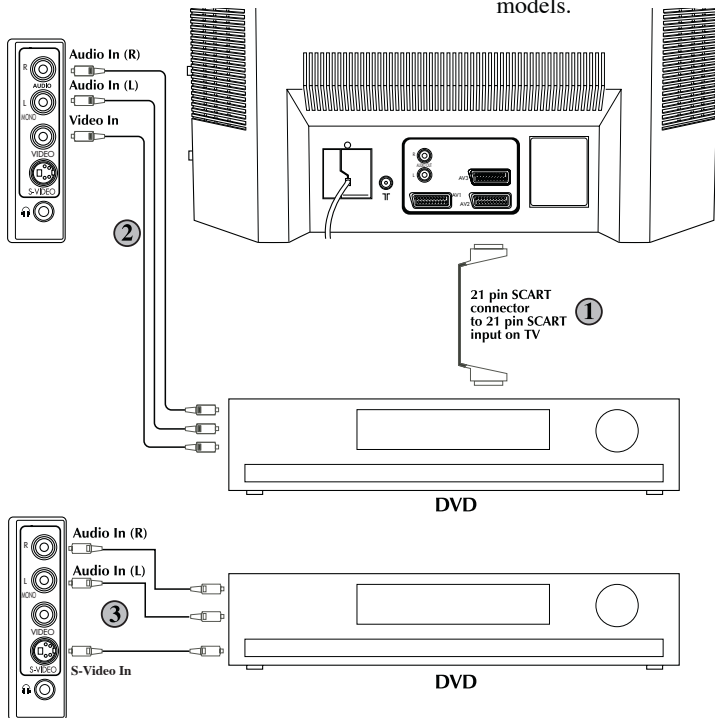

# Connecting a decoder

## ① Via SCART

Make sure the TV and decoder are both switched off.

Plug one end of the SCART lead (not supplied) into the back of the decoder and the other end into the SCART1 on the back of the TV.

Switch on the decoder and the TV.

AV

Press the **AV** button on the remote control to select AV1.

Plug one end of the RCA lead into the video and audio out sockets on the back of the decoder and plug the other end into the video and audio in sockets on the TV.

AV

Press the **AV** button repetitively and select the AV3 mode by two scart models or select AV4 mode by three scart models.

### Please Note

You can record from one external piece of equipment to another via the TV by connecting the playback to SCART 1 and the recorder to SCART 2 or SCART 3 and selecting AV1. You cannot watch the TV.

You can connect NTSC supported equipment to the TV via the SCART sockets and adjusting the colour via the PICTURE menu.

Select TINT by using **Program down** button and use the adjust the colour to **Volume up** and **down** buttons.

22

## ② Via RCA lead (optional)

Make sure the TV and decoder are both switched off.

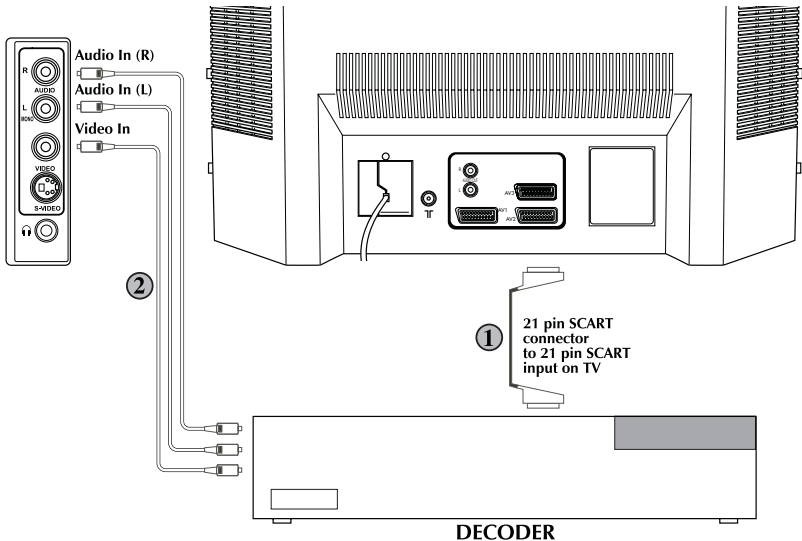

# Connecting TV with video and satellite/digital receiver

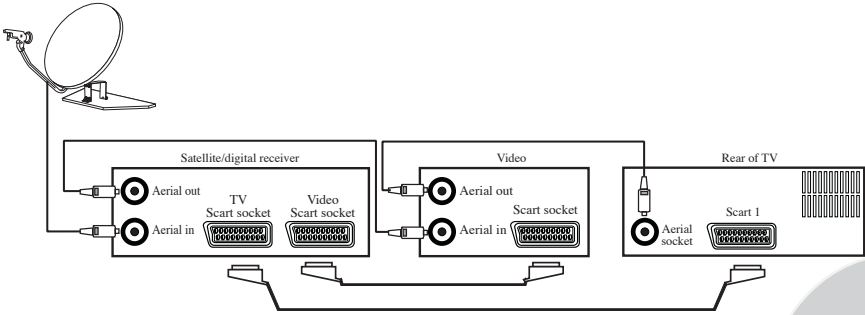

# Connecting TV with camcorder

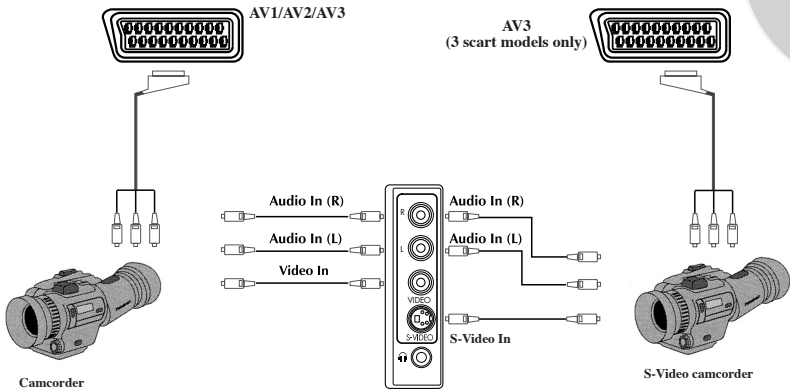

# Connecting TV games and computer

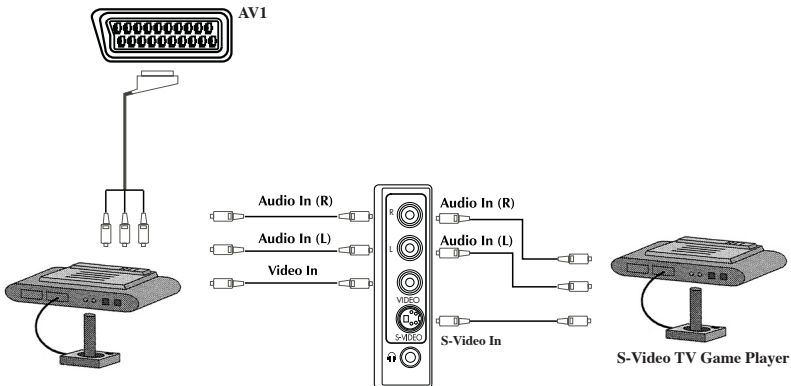





# Technical specifications table

Picture tube size/type	24" 16:9 SF	25" 4:3	26" 16:9 PF	28" 4:3	28" 16:9 SF	28" 16:9 PF	29" 4:3 SF	29" 4:3 PF	32" 16:9 SF	32" 16:9 PF	33" 4:3
Screen size	61 cm	63 cm	68 cm	70 cm	70 cm	70 cm	70 cm	72 cm	82 cm	82 cm	84 cm
Visible screen size	56 cm	59 cm	65 cm	66 cm	66 cm	66 cm	68 cm	68 cm	77 cm	77 cm	80 cm
Sound Output (%10 THD)	2x10 W	2x10 W	2x10 W	2x10 W	2x10 W	2x10 W	2x10 W	2x10 W	2x10 W	2x10 W	2x10 W
Power consumption	85 W	85 W	90 W	90 W	90 W	90 W	95 W	95 W	95 W	95 W	115 W
Stand by Power consumption	3 W	3 W	3 W	3 W	3 W	3 W	3 W	3 W	3 W	3 W	3 W
Subwoofer	—	—	optional	optional	optional	optional	optional	optional	optional	optional	optional
Dolby Virtual	optional	optional	optional	optional	optional	optional	optional	optional	optional	optional	optional

**SF** : Superflat picture tube

**PF** : Pureflat picture tube

**16:9**: Widescreen TV

**4:3** : Conventional TV

## Please note:

Using a subwoofer causes 20 W extra power consumption and supplies maximum 20 W extra sound output.

## General technical specifications

### Power Supply

**AC:** ..... 230-240V 50Hz

**Number of preset programmes** ..... 100

**RF Aerial input** ..... 75 ohm (unbalanced)

**Speaker empedance** ..... 8 ohm

**Audio output** ..... Mono/Stereo/NICAM (optional)

**Batteries** ..... 2x AAA

**Receiving channels** ..... VHF (Band I Channels 2-4)

..... VHF (Band III Channels 5-12)

..... UHF (Channels 21-69)

..... Cable TV (S1-S20/S21-S41)

**Receiving broadcast system**..... PAL BG

PAL SECAM BG

PAL SECAM BG DK/DK´

PAL SECAM BG LL´

PALI

**Please note:** Your TV set is produced to receive only “one “ of this colour and sound system options which is based on your country's norms and can not be changed by user except BG/DK and BG/LL´ if both systems are available to receive (BG or DK and BG or LL´). Please refer to “Tuning the TV”.