

Genova

Design by BoConcept

Samvejledning - Assembly Instructions - Montageanleitung - Instructions d'assemblage - Instrucciones de montaje

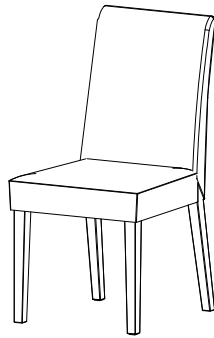

2300

93,3/47,3x48x59,3 cm

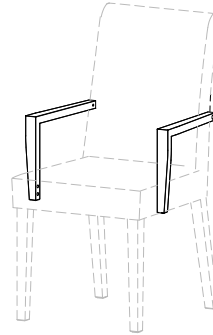

2310

93,3/47,3x54,6x59,3 cm

Korpus - Korpus - Carcase - Carcasse
Col. 1 / 2300

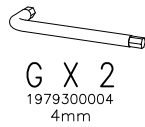
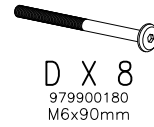
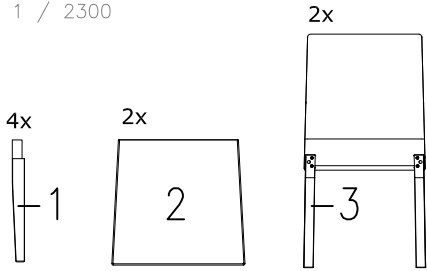

Col. 2 / 2310

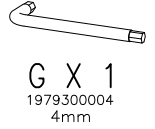
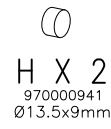
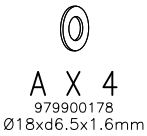
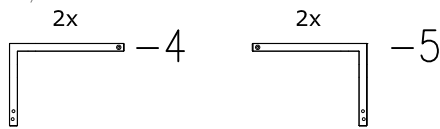

FIG. 1

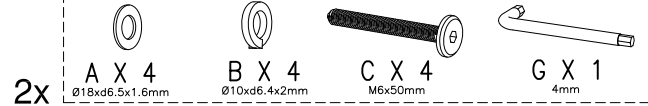
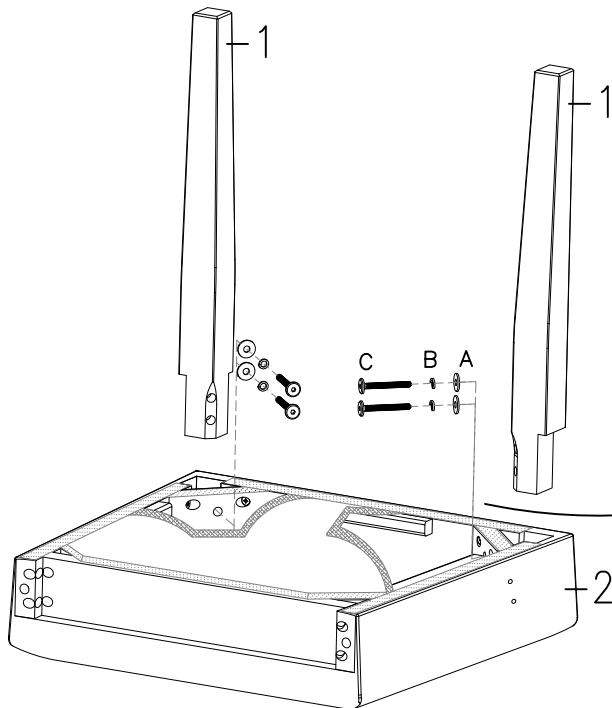







FIG. 2

- 
A X 4
 Ø18x6.5x1.6mm
- 
B X 4
 Ø10x6.4x2mm
- 
D X 4
 M6x90mm
- 
E X 2
 Ø10x30mm
- 
G X 1
 4mm

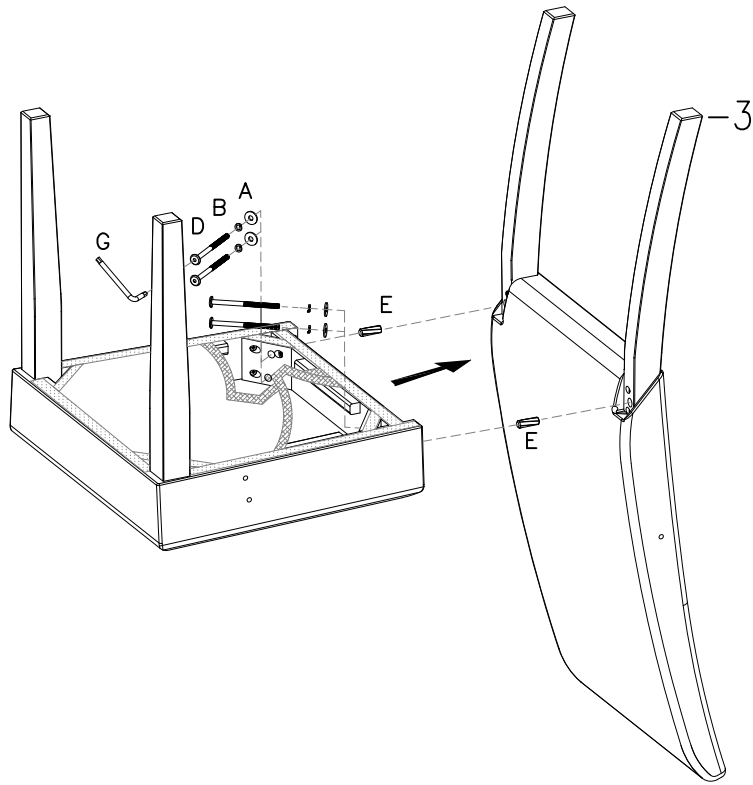

FIG. 3

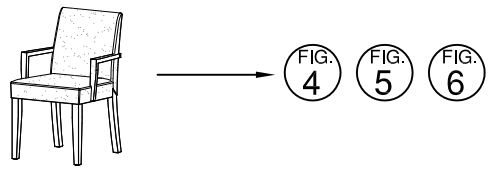
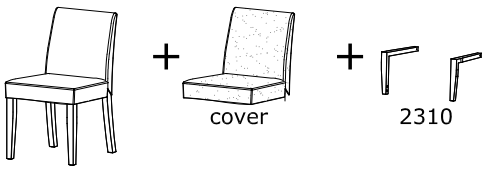
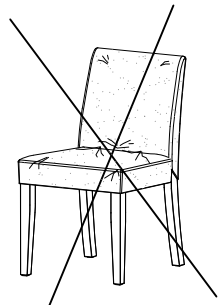
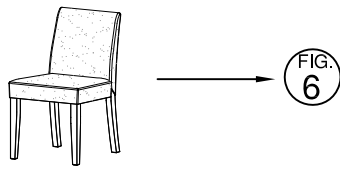
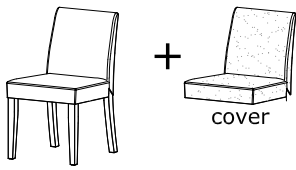

FIG. 4

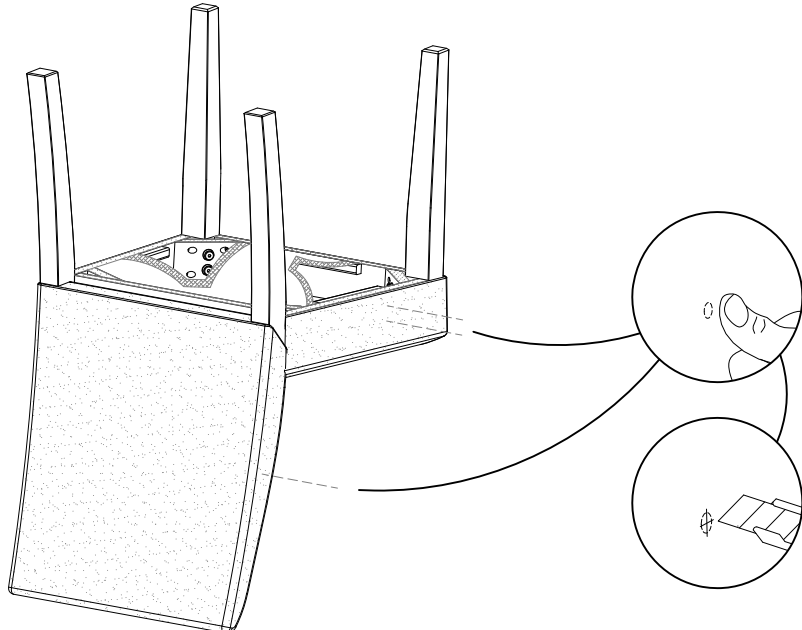



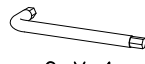



FIG. 5

- 
A X 4
Ø18x6.5x1.6mm
- 
B X 4
Ø10x6.4x2mm
- 
E X 5
M6x40mm
- 
G X 1
4mm
- 
H X 2

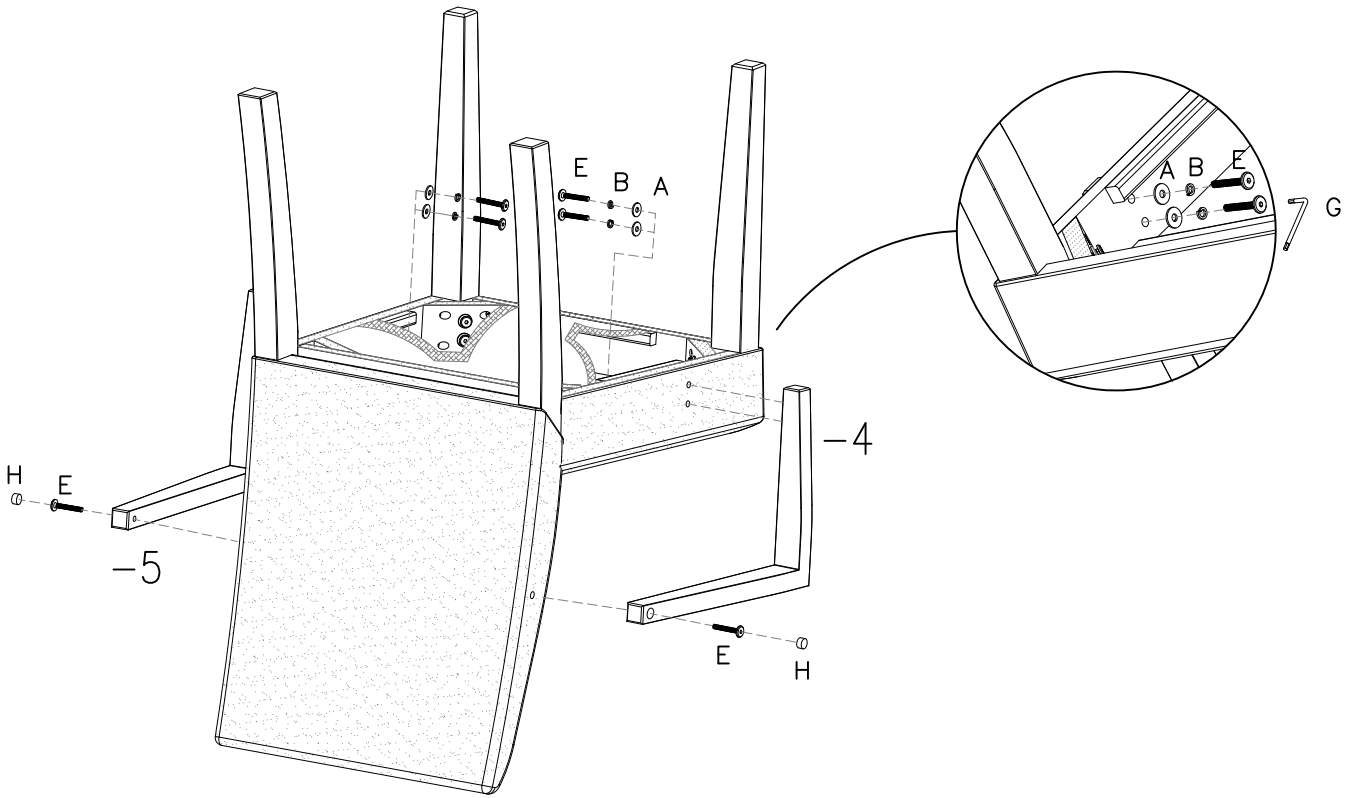

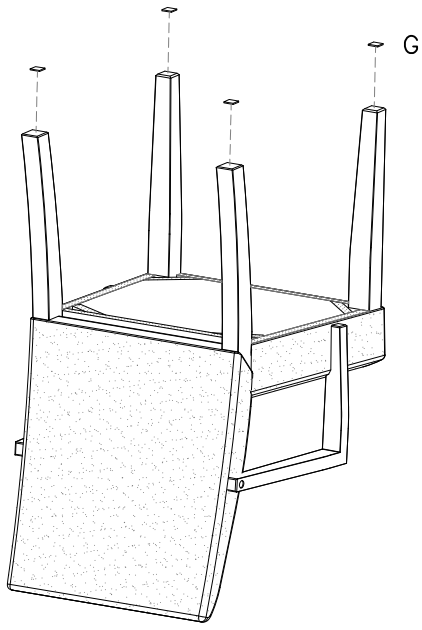

FIG. 6

- 
I X 4
20X20X2mm



!

DK Ved reklamation oplyses følgende:
 D Im Reklamationsfall, bitte folgendes erläutern:
 US In case of claims, please state the following:
 F En cas de réclamation, veuillez indiquer:
 NL Bij service volgene mededelen
 E En caso de reclamacion, indicar lo siguiente:
 P No caso de reclamação, por favor indique o seguinte:
 JP お気づきの点等ございましたら、以下の点をお知らせください。

Example!

Korpus - Korpus - Carcase - Carcasse	Beslag - Fittings - Beschläge - Set de Montage
