

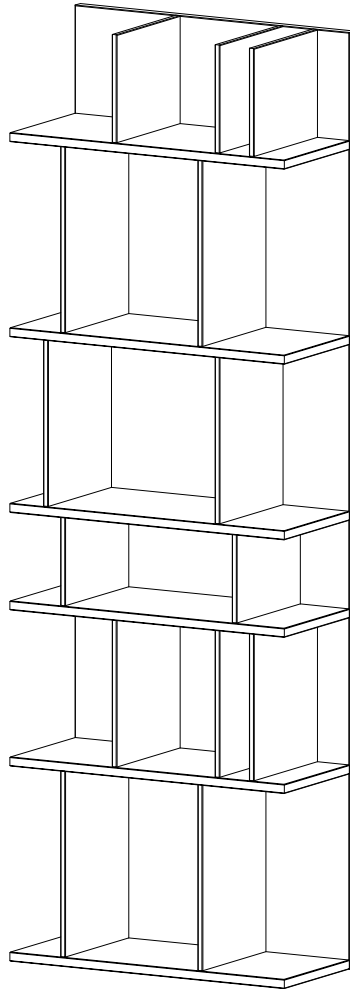

Occa

Design by BoConcept

Samlevejledning - Assembly Instructions - Montageanleitung - Instructions d'assemblage - Instrucciones de montaje



1120

153,6x51,2x21,55 cm  max. 25kg

Col. 1

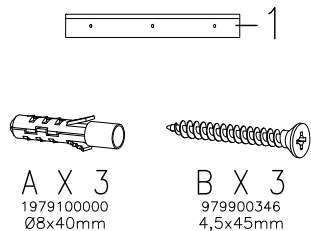
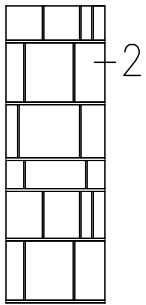

Værktøj - Werkzeuge - Tools - Outils

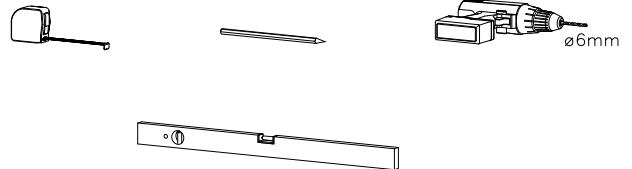

Attention!

- DK: Vægforhold kan bevirke, at det ikke er tilrådeligt at benytte de medfølgende skruer/rawplugs.
- US: The condition of the wall may mean that it is inadvisable to use the enclosed screws and rawplugs.
- D: Die Wandbeschaffenheit kann ggf. dazu führen, dass eine Verwendung der beigefügten Schrauben/Dübel nicht ratsam ist.
- E: Las condiciones de la pared pueden dar lugar a que no sea recomendable utilizar los tornillos/tacos adjuntos.

- F: Veuillez noter que les vis ou les chevilles jointes ne conviennent pas à tous les types de mur.
- NL: Er zijn muren waarin het niet valt aan te bevelen om de bijgevoegde schroeven/rawplugs te gebruiken.
- P: As condições da parede podem fazer com que seja recomendável utilizar os parafusos/buchas de fundo incluídos.
- JP: 壁の状態によっては、製品付属のネジやロープラグの使用は避けた方がよい場合があります。

FIG. 1

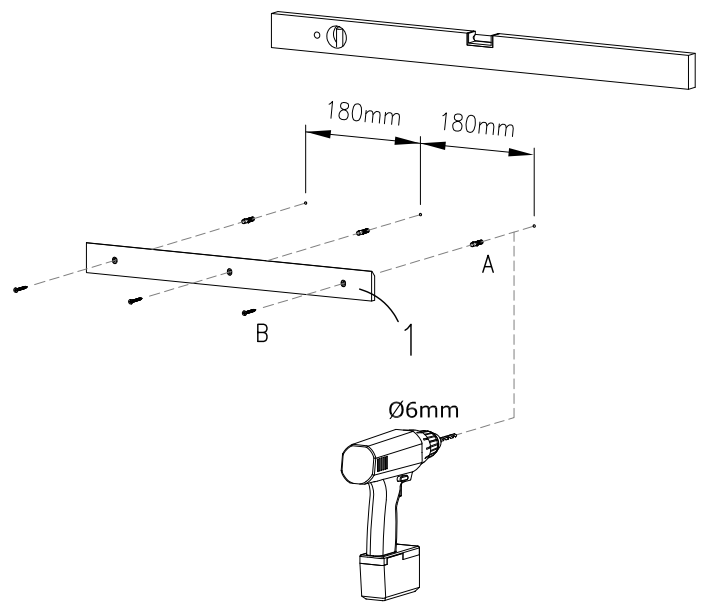
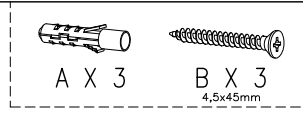
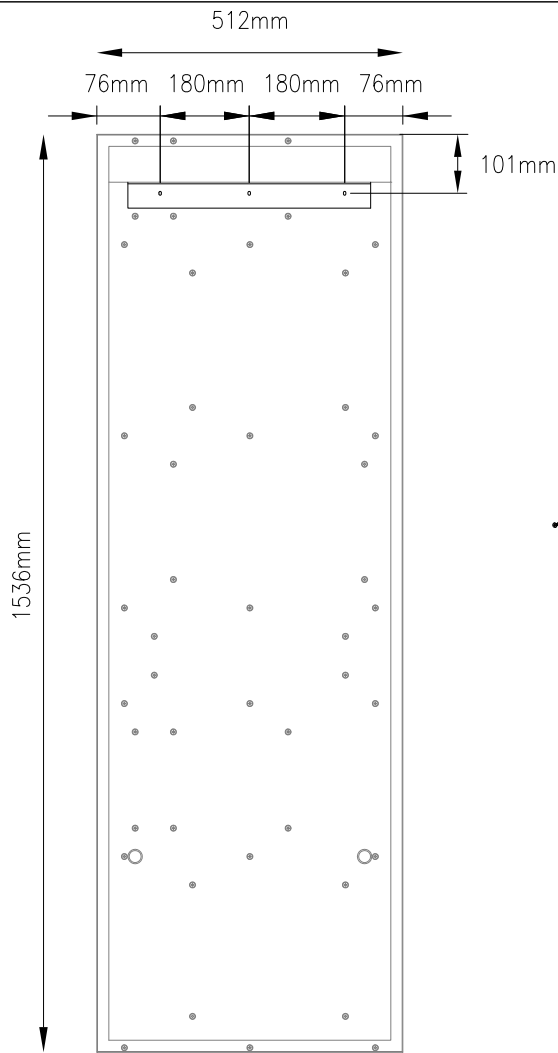
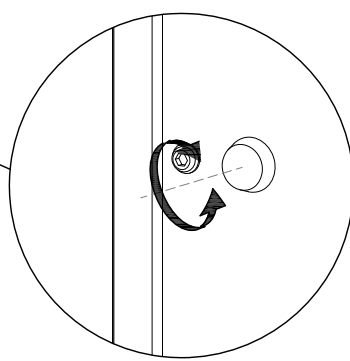
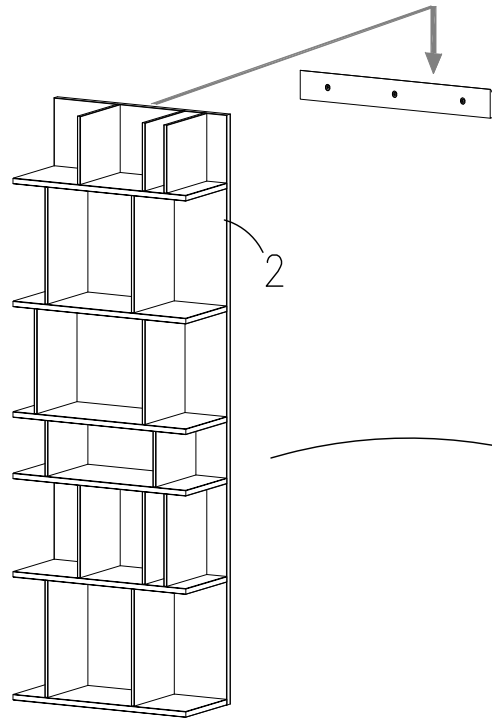

FIG. 2



Justering
Justierung
Adjusting
Réglage
Bijstelling
Ajuste
Regolazione
Afinação

DK Ved reklamation oplyses følgende:
 D Im Reklamationsfall, bitte folgendes erläutern:
 US In case of claims, please state the following:
 F En cas de réclamation, veuillez indiquer:
 NL Bij service volgene mededelen
 E En caso de reclamacion, indicar lo siguiente:
 P No caso de reclamação, por favor indique o seguinte:
 JP お気づきの点等ございましたら、以下の点をお知らせください。

Example!

Korpus - Korpus - Carcase - Carcasse	Beslag - Fittings - Beschläge - Set de Montage