

Occa

Design by BoConcept

Samvejledning - Assembly Instructions - Montageanleitung - Instructions d'assemblage - Instrucciones de montaje

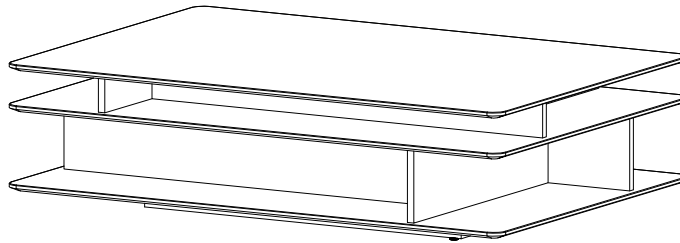

4500

34x125x85 cm

Korpus - Korpus - Carcase - Carcasse

Col. 1

002085

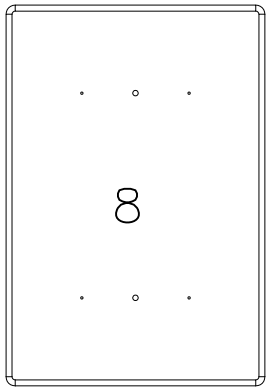

8

002086

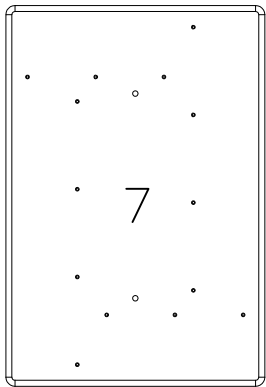

7

Col. 2

002084

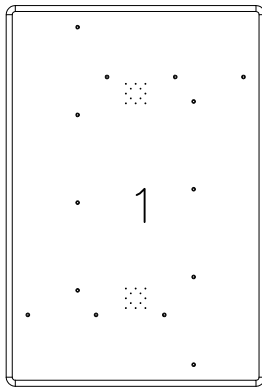

1

002121

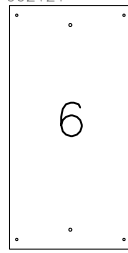

6

x2 002104 : 3

x2 002106 : 5

x2 002103 : 2

x2 002105 : 4

Beslag - Beschläge - Fittings - Set de montage - Acessórios

Col. 2



A X 2
970001125



B X 24
1978104515
4,5x15mm



C X 2
970000883
D12,9x6,5 M8

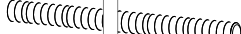

D X 2
970001126
M8x312mm



E X 76
1979110830
8x30mm



F X 4
1976001934
M6x8mm

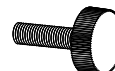

G X 4
1976001935
M6



H X 2
970000706
M8x13



J X 1
1979300005
5mm

Værktøj - Werkzeuge - Tools - Outils

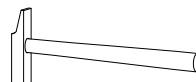
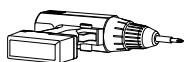

Attention!

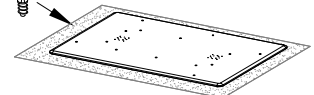

FIG. 1

- 
A X 2
- 
B X 24
4,5x15mm
- 
C X 2
D12,9x6,5 M8
- 
D X 2
M8x312mm

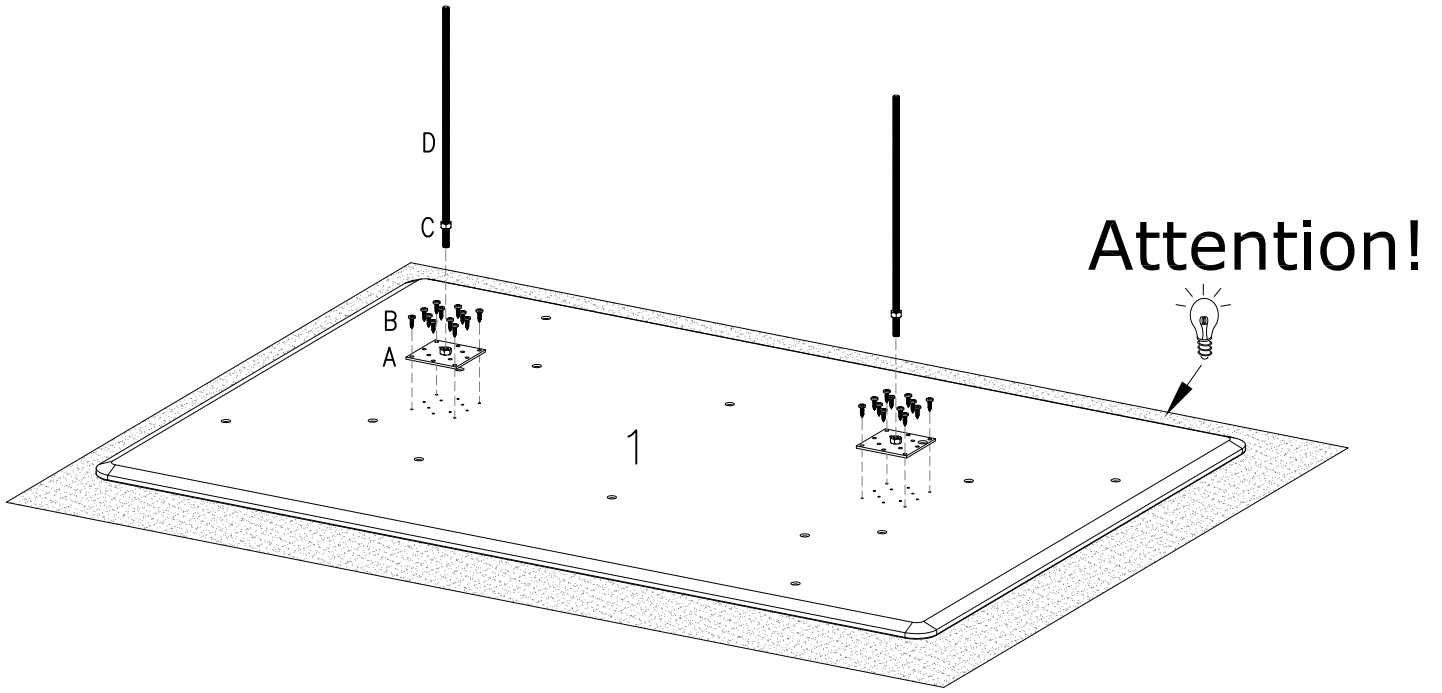
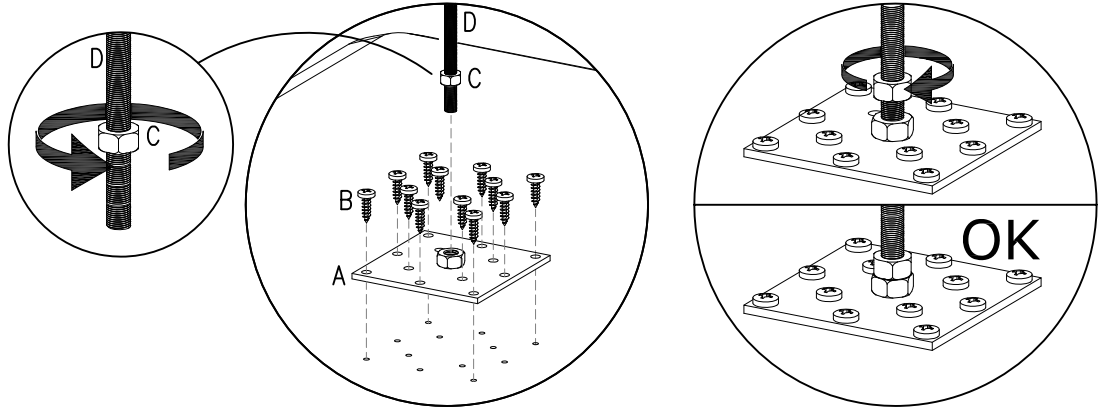



FIG. 2

- 
E X 72
8x30mm

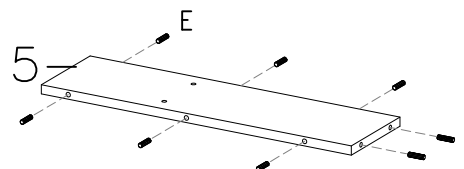
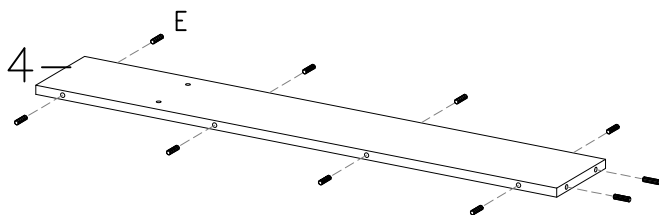
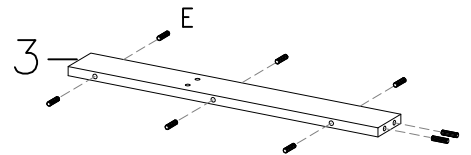
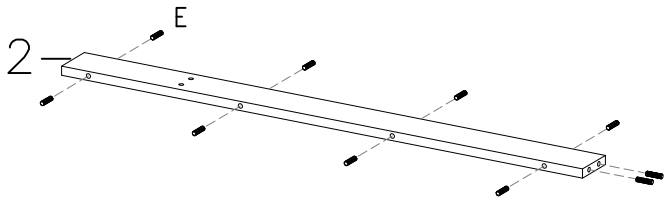

FIG.
3

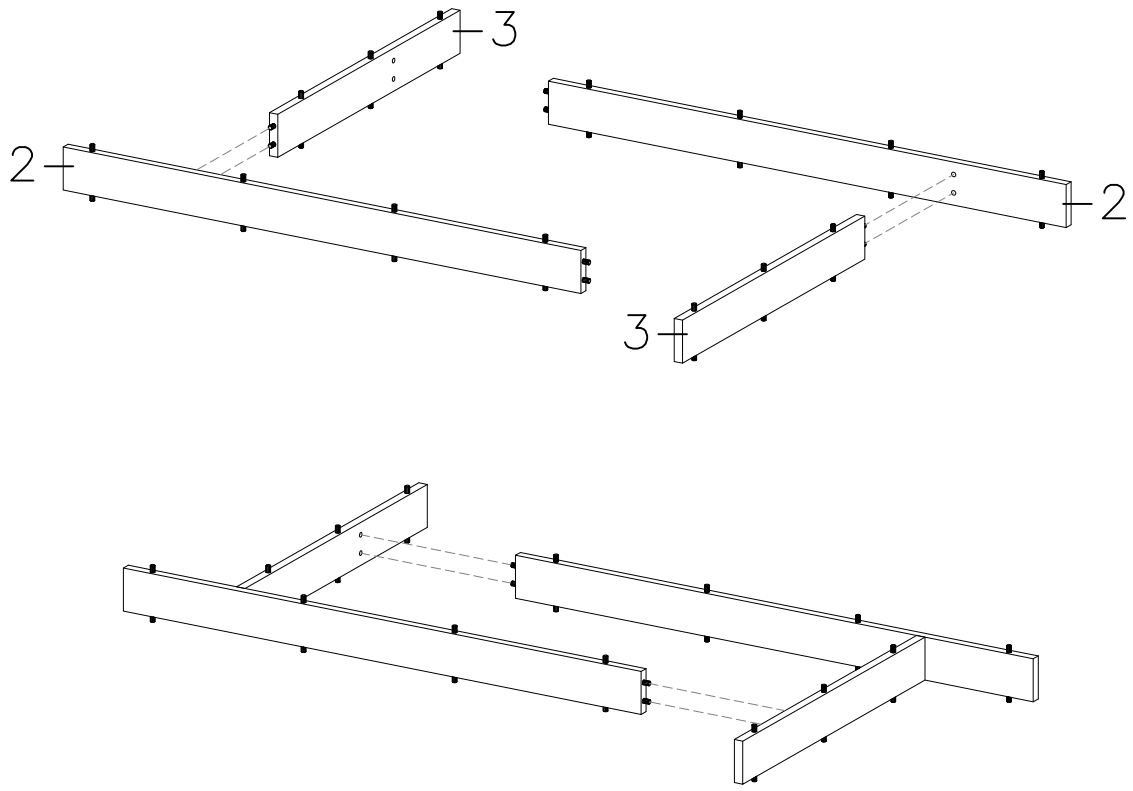

FIG.
4

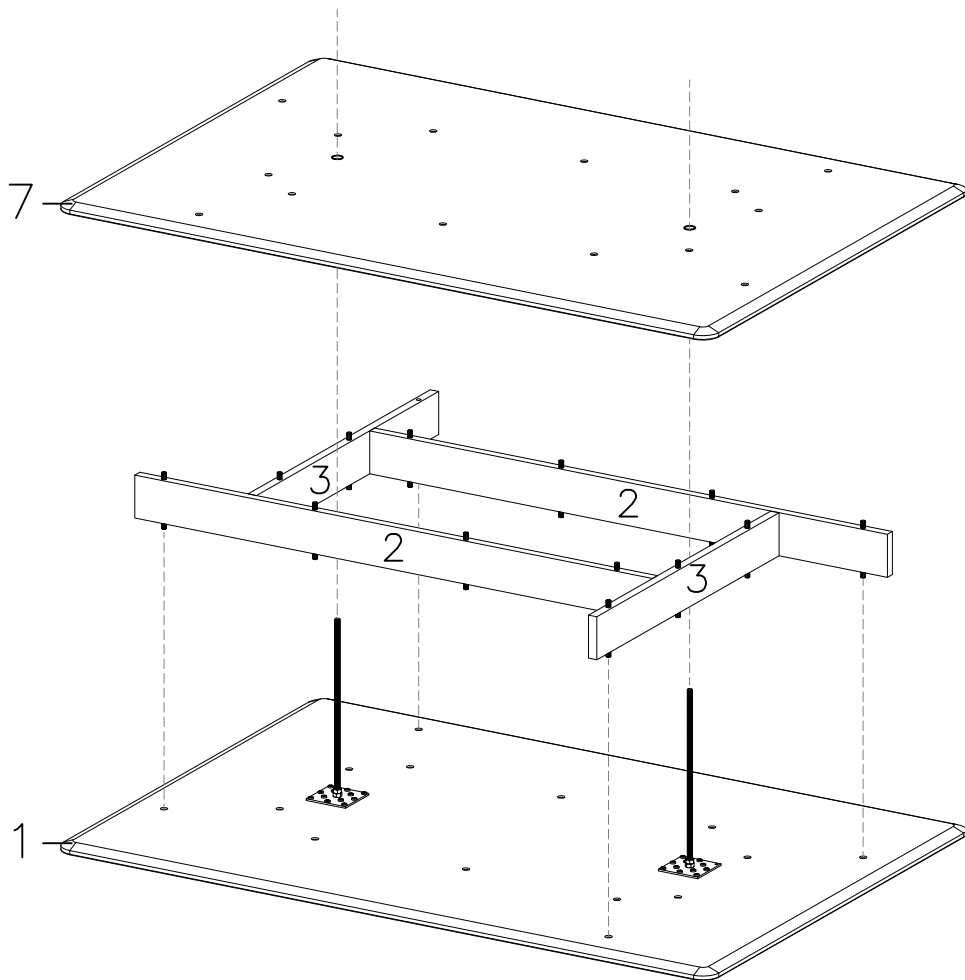

FIG. 5

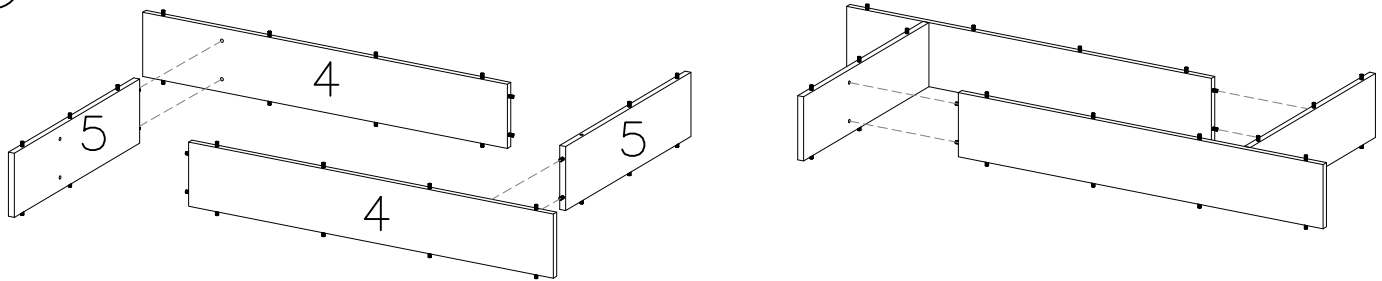
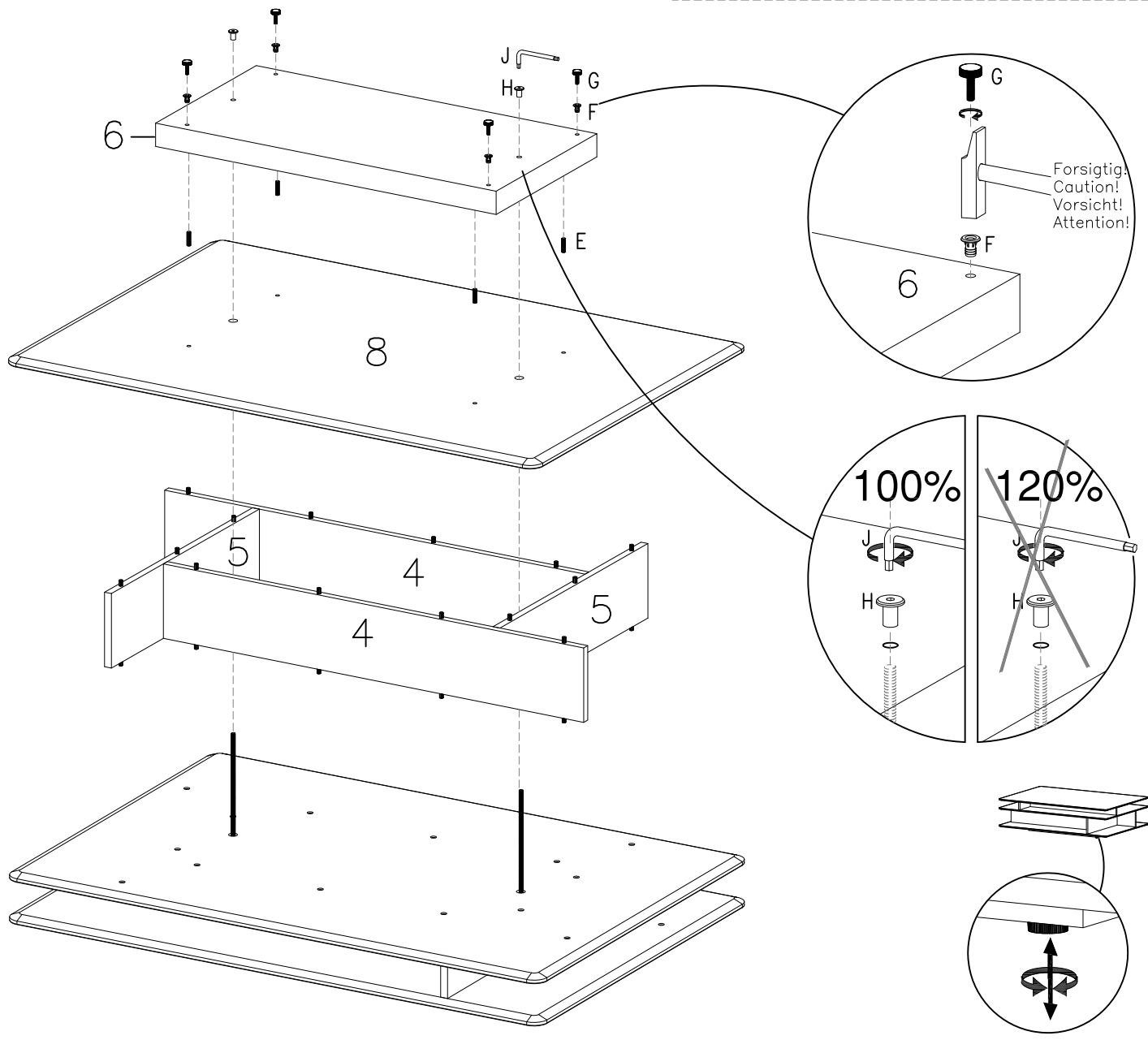
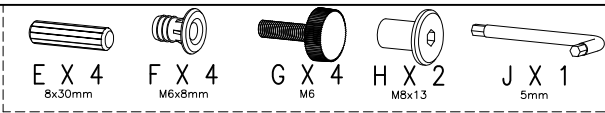

FIG. 6



! DK Ved reklamation oplyses følgende:
 D Im Reklamationsfall, bitte folgendes erläutern:
 US In case of claims, please state the following:
 F En cas de réclamation, veuillez indiquer:
 NL Bij service volgenez mededelen
 E En caso de reclamación, indicar lo siguiente:
 P No caso de reclamação, por favor indique o seguinte:
■ JP お気づきの点等ございましたら、以下の点をお知らせください。

Example!

Korpus - Korpus - Carcase - Carcasse		Beslag - Fittings - Beschläge - Set de Montage		