

Schelly

Made in Denmark

Samvejledning - Assembly Instructions - Montageanleitung - Instructions d'assemblage - Instrucciones de montaje



610014
6100+1403



610015
6100+1503

6100

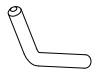
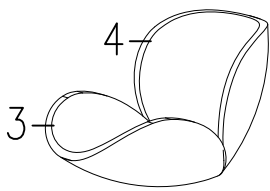

C X 2
6951000100



D X 1

1403

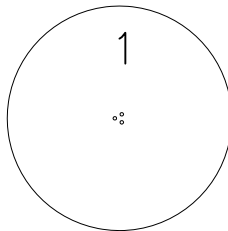

A X 1
1979300005
5mm

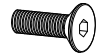

B X 3
970001052
M8x25mm

1503

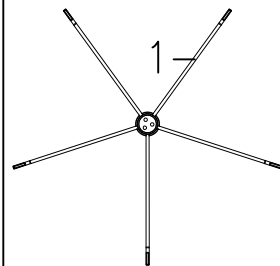

A X 1
1979300005
5mm

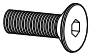

B X 3
970001052
M8x25mm

FIG. 1

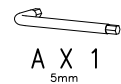

A X 1
5mm



B X 3
M8x25mm

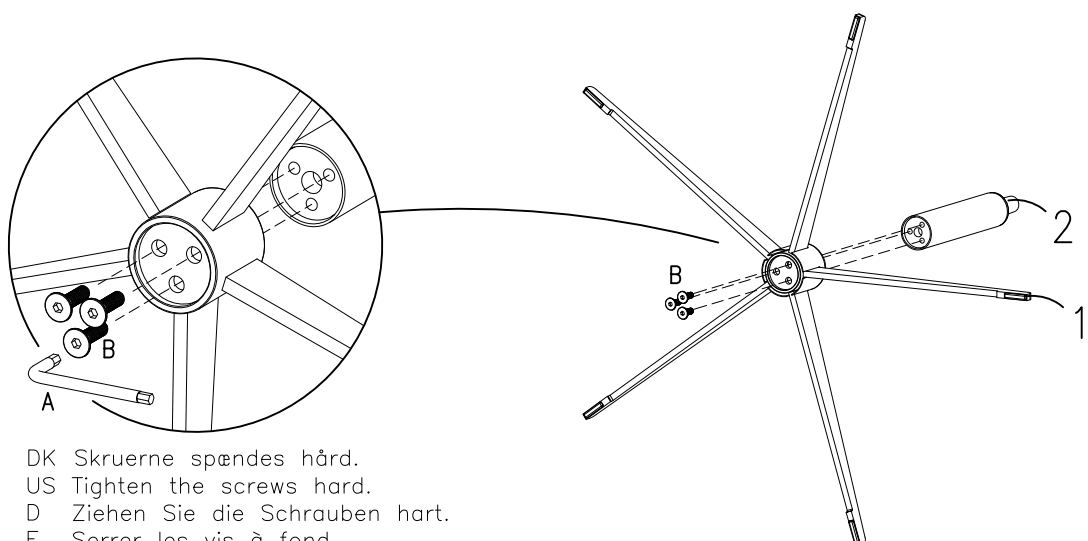

DK Skruerne spændes hård.
US Tighten the screws hard.
D Ziehen Sie die Schrauben hart.
F Serrer les vis à fond
NL Schroeven hard aandraaien.
E Aprieta fuerte los tornillos
P Aperte os parafusos com força
JP 「ネジを固く締めます」。

FIG. 2

C X 2

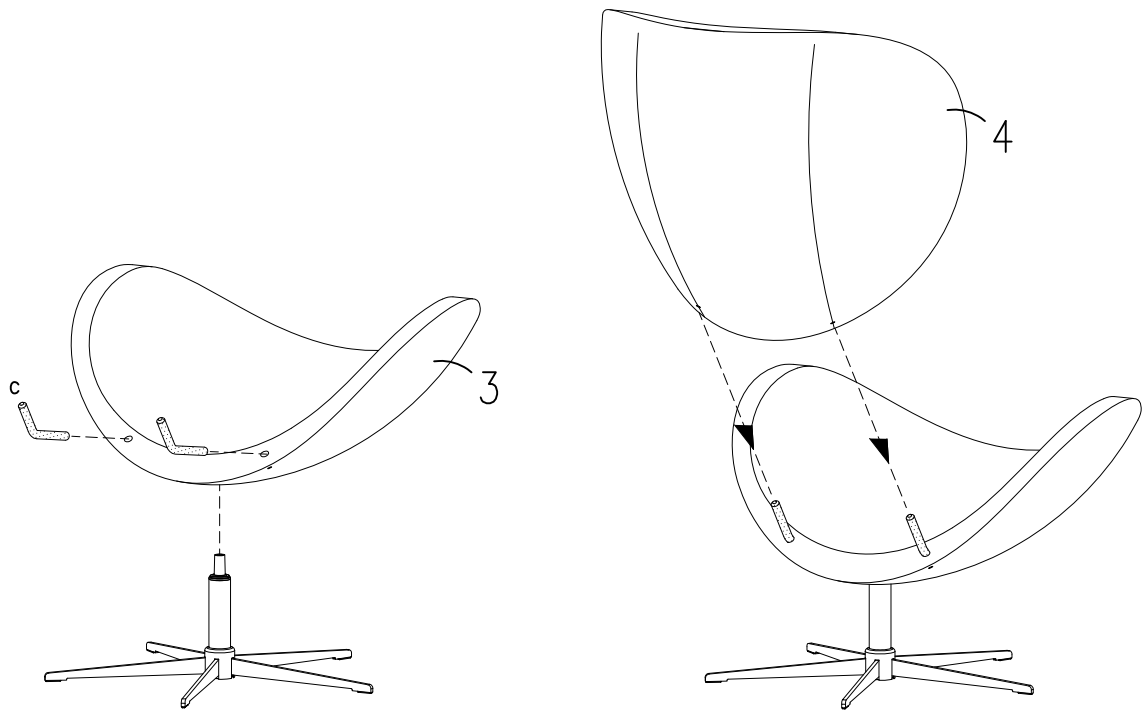

FIG. 3

D X 1

