

# Installation manual

Montageanleitung • Notice de montage • Istruzioni per il montaggio • Manual de montaje

## Log cabin FRB28-2924P

Blockhaus • Maisonnette en poutres • Casa di travi • Casa de jardin

Width 290 x Depth 235 x Height 228 cm









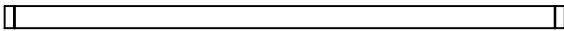
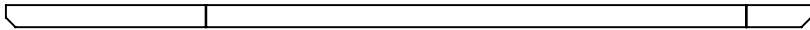
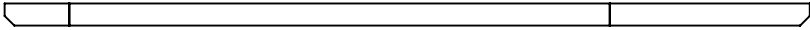
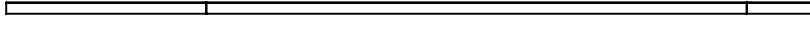
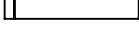
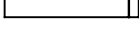
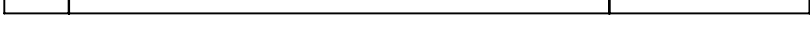
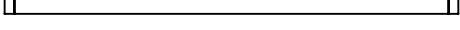
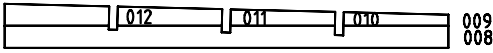
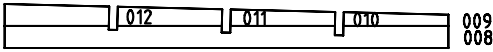
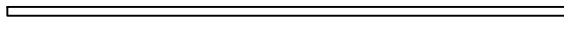
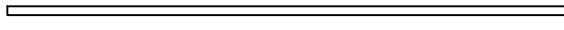
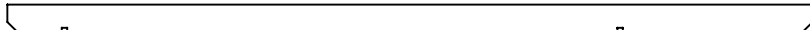

Breite/Tiefe/Höhe • Largeur/Profondeur/Hauteur • Lunghezza/Profondita/Altezza • Ancho/Profundidad/Altura

Log thickness 28 mm















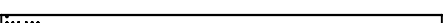

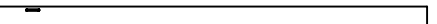

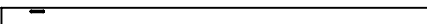

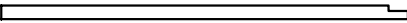
Bohlenstärke • Épaisseur des murs • Spessore delle pareti • Grosor de pared



The producer shall have the right to make technical changes to the product • Technische Änderungen vorbehalten • Le producteur réserve le droit d'effectuer des modifications techniques au produit • Il produttore mantiene il diritto di apportare modifiche tecniche al prodotto • Reservado el derecho a modificaciones técnicas

Pos	SPECIFICATION-STÜCKLISTE-NOMENCLATURE-ELEMENTI-ESPECIFICACIÓN -FRB28-2924P-	Pcs	Profile (mm)	Length (mm)
001		19	28x114	2872
002(1)		1	28x114	4162
002(2)		1	28x114	4162
003		1	28x57	4162
004		17	28x114	681
005		17	28x114	681
006		1	28x114	4162
007		36	28x114	2322
WA-1		1		
WB-1		1		
AR1	Foundation- Fundament- Fondation- Fondazione- Vigas de cimentación 	2	45x70	2870
AR2	Foundation- Fundament- Fondation- Fondazione- Vigas de cimentación 	3	45x70	2890
PR1		3	44x140	4162
061	Floor board- Fussbodenbrett- Madrier du plancher Tavola pavimento- Tabla de suelo 	32	89x19	2289
070	Roof board- Dachbrett- Madrier du toit- Tavola tetto- Tabla de tejado 	47	89x19	2810
130	Floor beading- Fussbodenleiste- Baguette du plancher- Listello pavimento- Listón de suelo 	2	19x19	2256
131	Floor beading- Fussbodenleiste- Baguette du plancher- Listello pavimento- Listón de suelo 	2	19x19	2844
090	Eave edging- Dachrandbrett- Madrier en bordure du toit- Tavola bordo tetto- Tabla de voladizo 	2	105x19	2912
091	Eave edging- Dachrandbrett- Madrier en bordure du toit- Tavola bordo tetto- Tabla de voladizo 	2	114x19	2912
092	Eave edging- Dachrandbrett- Madrier en bordure du toit- Tavola bordo tetto- Tabla de voladizo 	2	105x19	4200
093	Eave edging- Dachrandbrett- Madrier en bordure du toit- Tavola bordo tetto- Tabla de voladizo 	2	114x19	4200
094	Covering board- Deckbrett- Madrier de couverture Tavola di copertura- Listón de cubierta 	2	70x19	2880
095	Covering board- Deckbrett- Madrier de couverture Tavola di copertura- Listón de cubierta 	1	70x19	4200



Pos	SPECIFICATION-STÜCKLISTE-NOMENCLATURE-ELEMENTI-ESPECIFICACIÓN -FRB28-2924P-	Pcs	Profile (mm)	Length (mm)
097	Connecting board -Verbindungs Brett -Madrier de connection Tavola di collegamento- Listón de juntura 	3	120x28	281
080	Roof edge reinforcement- Dachrandleiste- Baguette en bordure du toit- Rinforzo bordo tetto- Refuerzo borde tejado 	2	32x40	4162
098	Connecting board -Verbindungs Brett -Madrier de connection Tavola di collegamento- Listón de juntura 	3	140x44	287
140	Corner post- Eckständer- Cornier- Palo di angolo Poste de la esquina 	1	54x54	2276
141	Corner post- Eckständer- Cornier- Palo di angolo Poste de la esquina 	1	54x54	2276
142	Corner post- Eckständer- Cornier- Palo di angolo Poste de la esquina 	1	54x54	2222
143	Corner post- Eckständer- Cornier- Palo di angolo Poste de la esquina 	1	54x54	2222
144	Covering board- Deckbrett- Madrier de couverture Tavola di copertura- Listón de cubierta 	4	95x16	2052
145	Covering board- Deckbrett- Madrier de couverture Tavola di copertura- Listón de cubierta 	2	95x16	2222
146	Covering board- Deckbrett- Madrier de couverture Tavola di copertura- Listón de cubierta 	2	95x16	2280
156	Slat - Leiste - Baguette - Listello- Listón 	1	19x19	1510
160	Post -Pfosten -Poutre -Montante- Poste 70x70 	2	70x70	2170
300	Fixing kit- Befestigungsset- Moyens de fixation Materiale di fissaggio- Kit de fijación 	1		
	Cylinder - Zylinderschloss - Serrure a mortaiser - Serratura a cilindro 	1		
	Door fittings- Türbeschlag- Ferrure- Ferramenta porta Manilla (puerta) 	1		
	L-iron - Winkel - Angle - Angolo- Ángulo 20x20x40 	14		
	Nail- Nagel- Clou- Chiodo- Clavo- 1.4x40mm 	24		
	Nail- Nagel- Clou- Chiodo- Clavo- 2.5x50mm 	500		
	Screw- Schraube- Vis- Vite- Tornillo- 3.5x40mm 	180		
	Screw- Schraube- Vis- Vite- Tornillo- 3x30mm 	60		
	Screw- Schraube- Vis- Vite- Tornillo- 4.5x70mm 	40		
	Screw- Schraube- Vis- Vite- Tornillo- 6.4x40mm  2276-64 40	8		
	Glue- Leim- Colle- Colla- Pego de tela asfáltica- 1L	1		

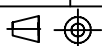

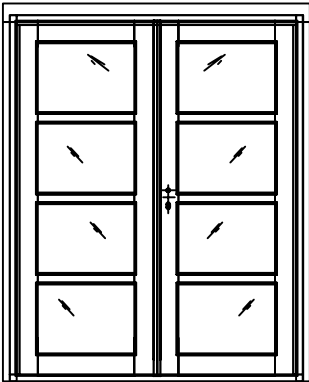
Pos	SPECIFICATION-STÜCKLISTE-NOMENCLATURE-ELEMENTI-ESPECIFICACIÓN -FRB28-2924P-	Pcs	Profile (mm)	Length (mm)
	Adjustment bolt- Senkbolzen- Boulon de réglage Bullone di regolamento- Perno de ajuste	2		
	Keeper- Schliessblech- Toile- Lamiera- Aldaba de candado	2		
	Screw- Schraube- Vis- Vite- Tornillo- 2.5x16mm	4		
TU-2813R	Door - Tür - Porte - Porta-Puerta 1500x1873 	1		



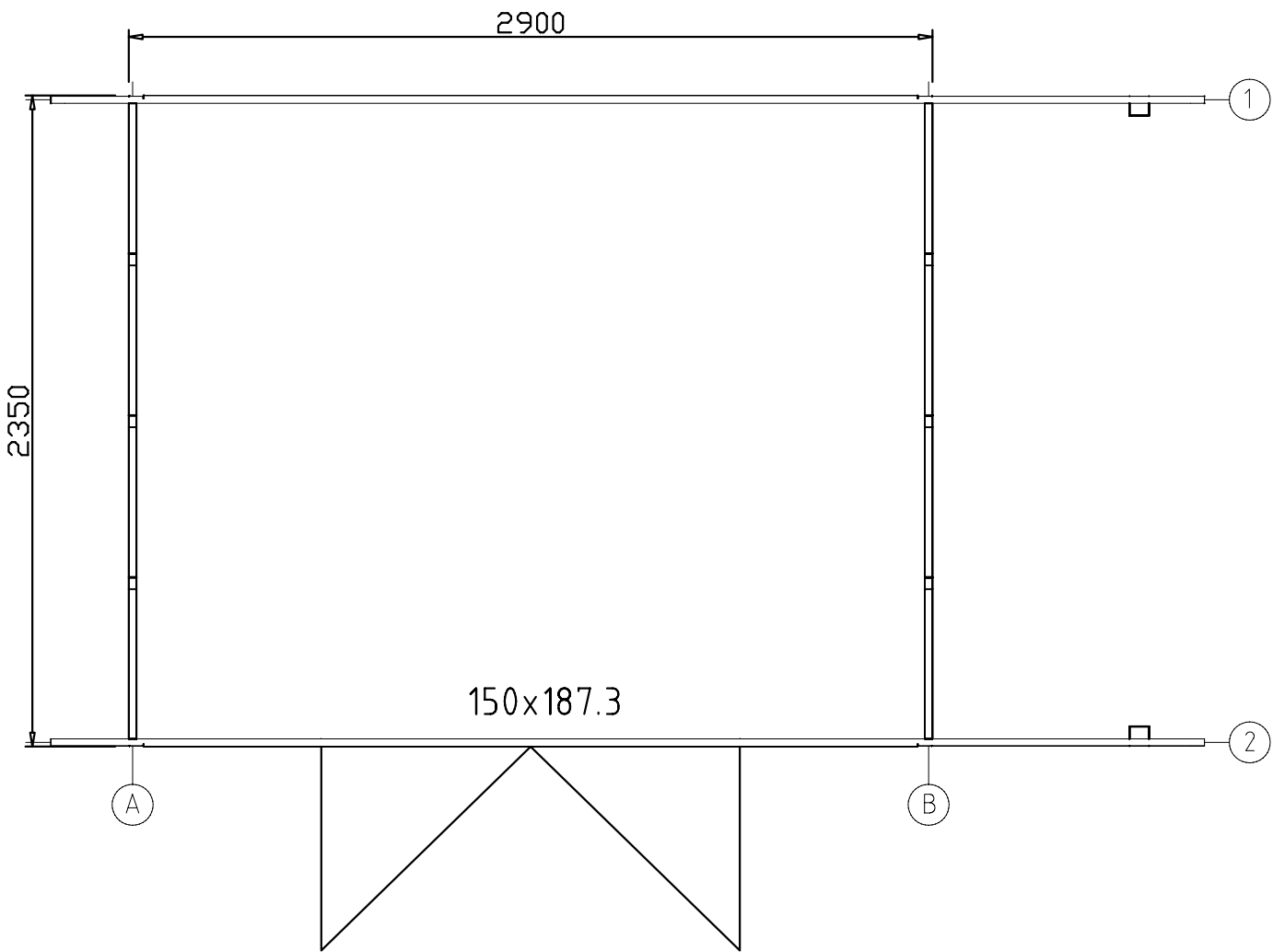

13.08.2008 11:19:15

L-irons + 3x30  
NB ! Details 140-143 can not base on foundation !

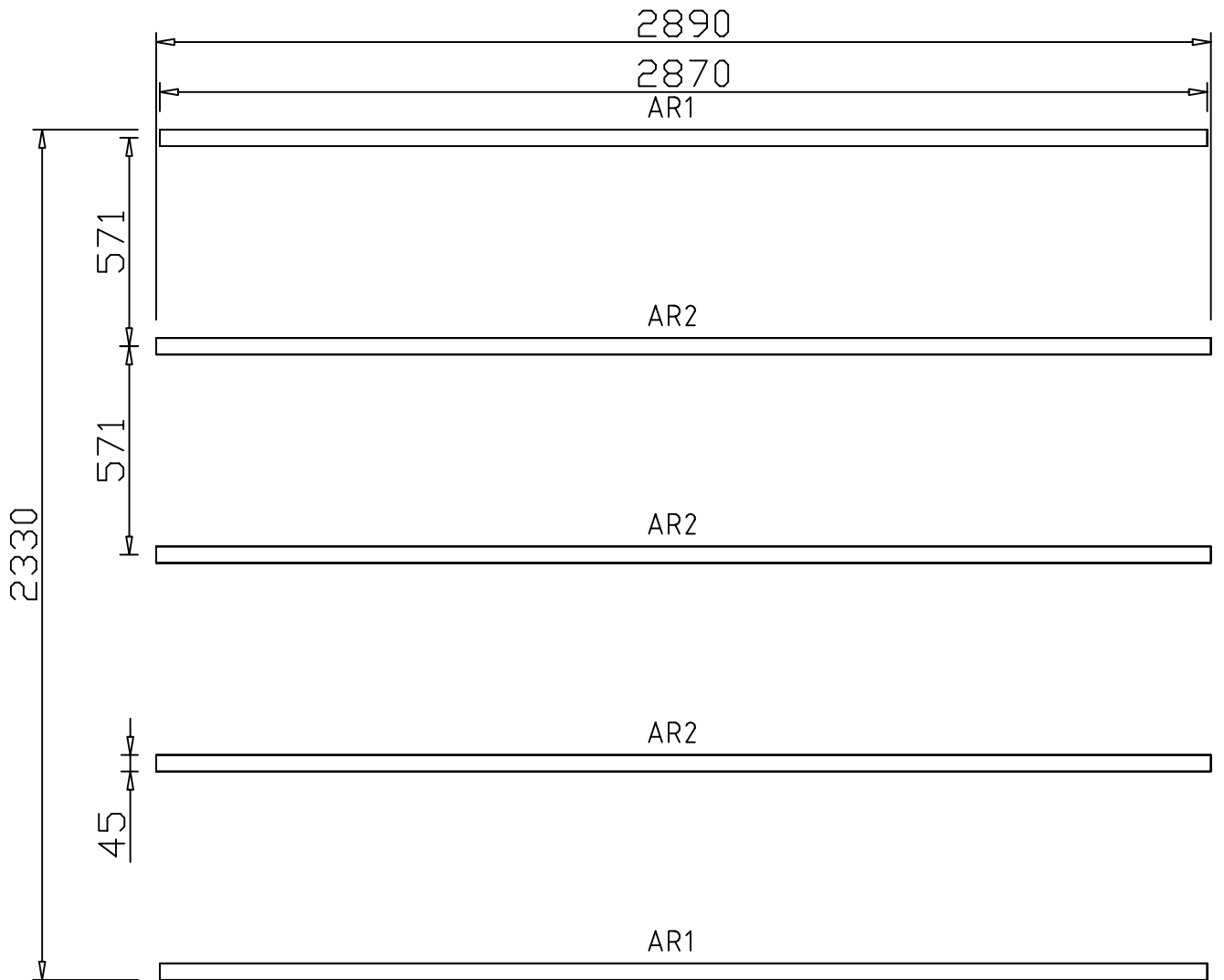

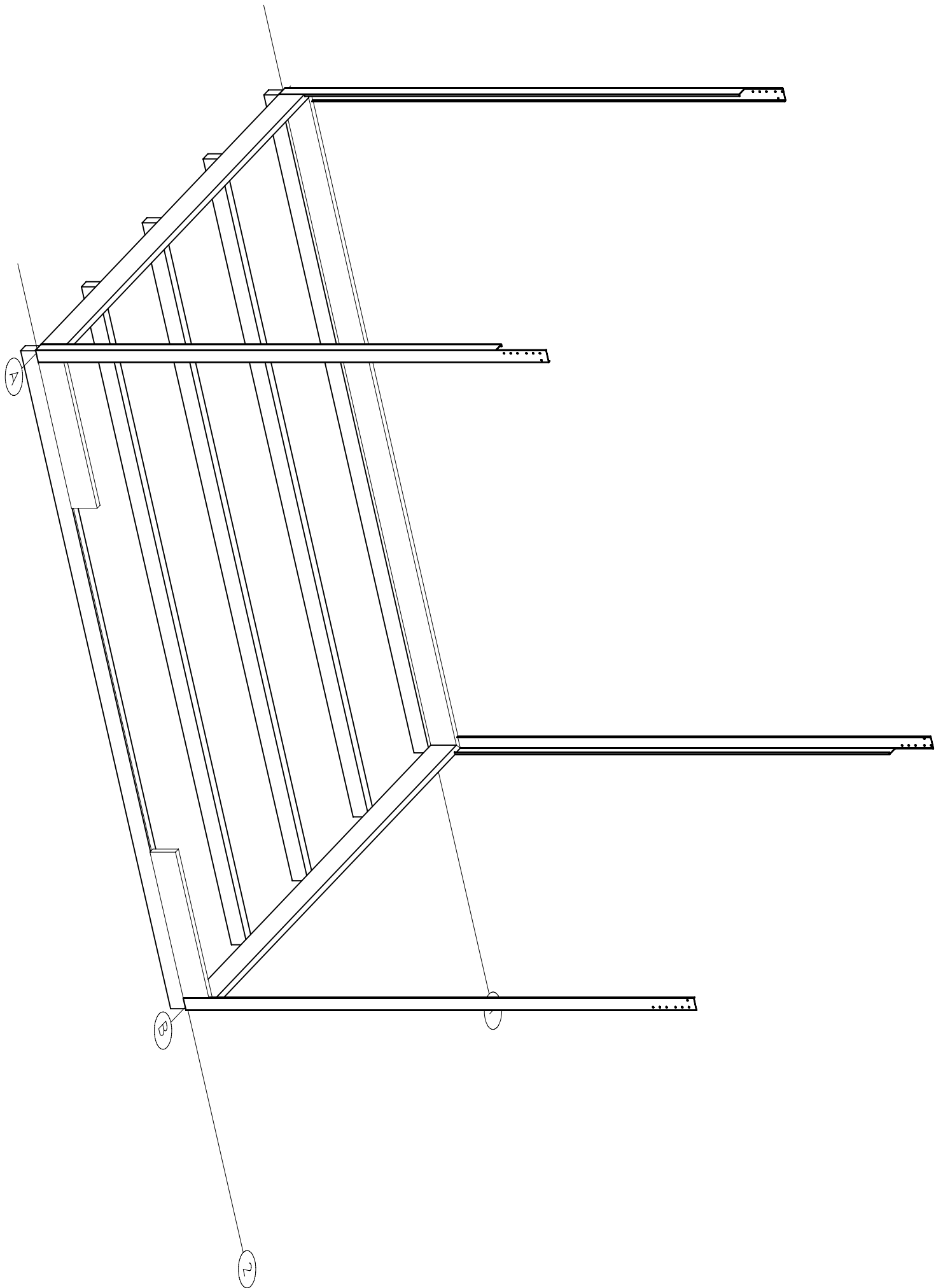

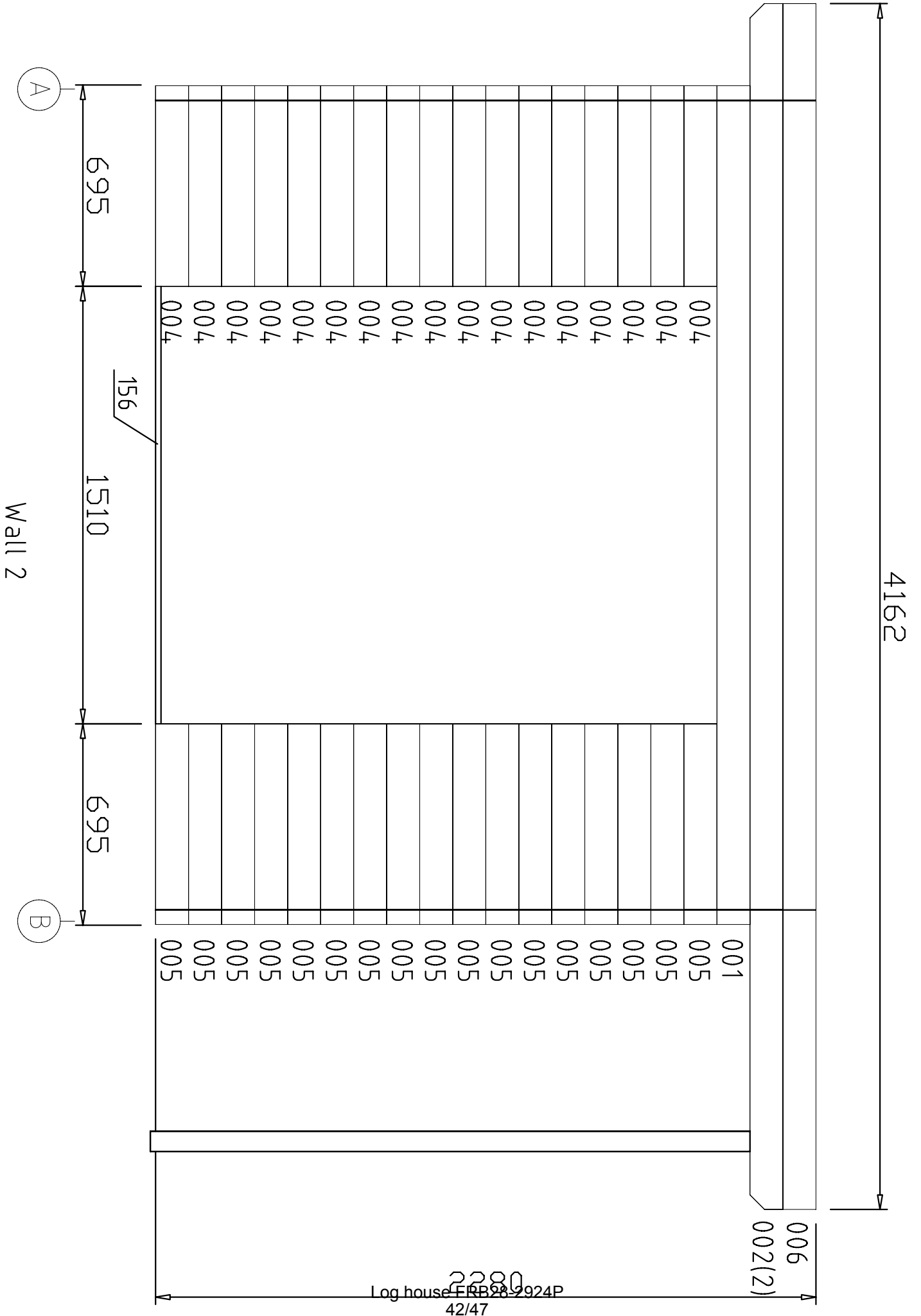



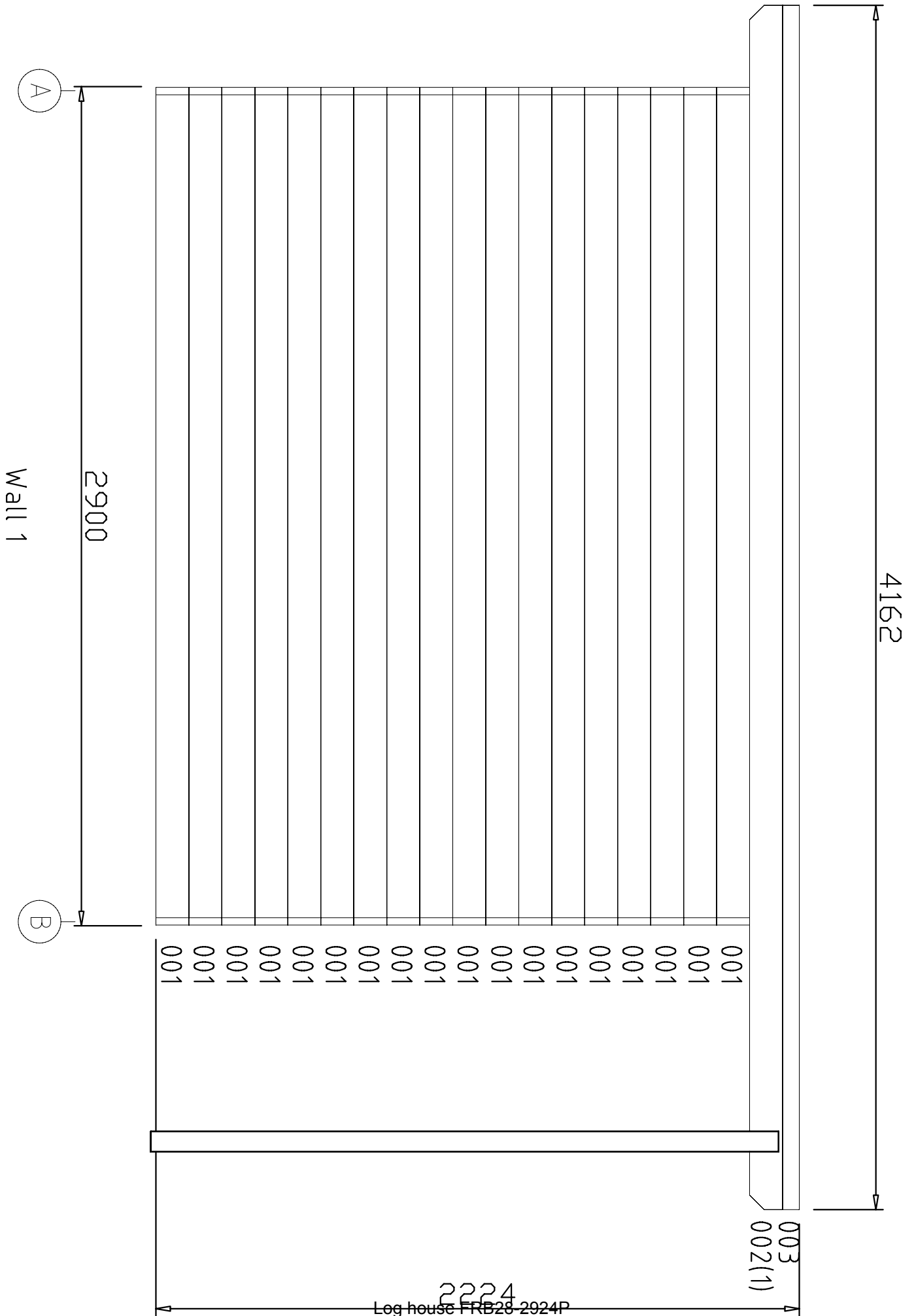

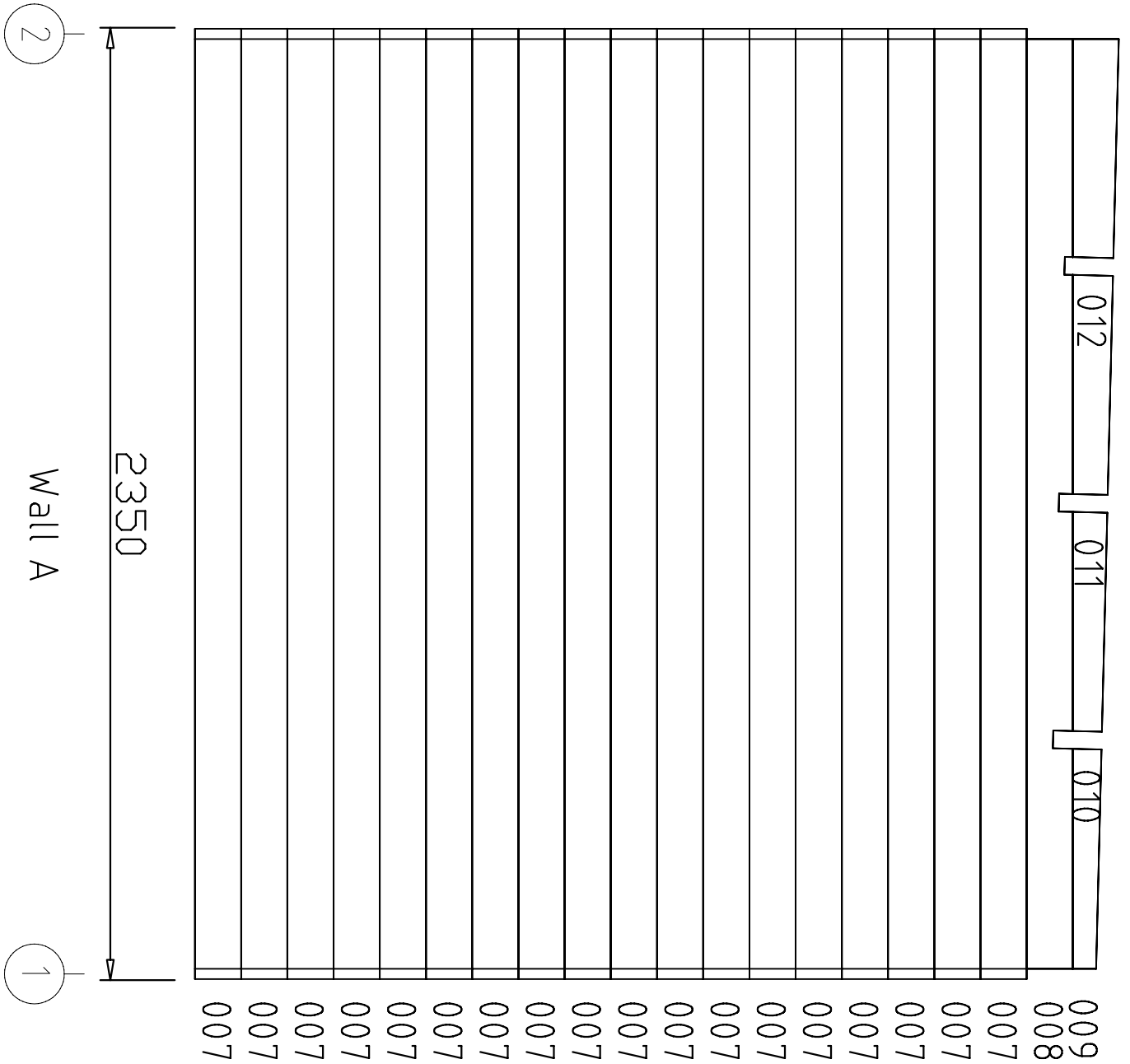

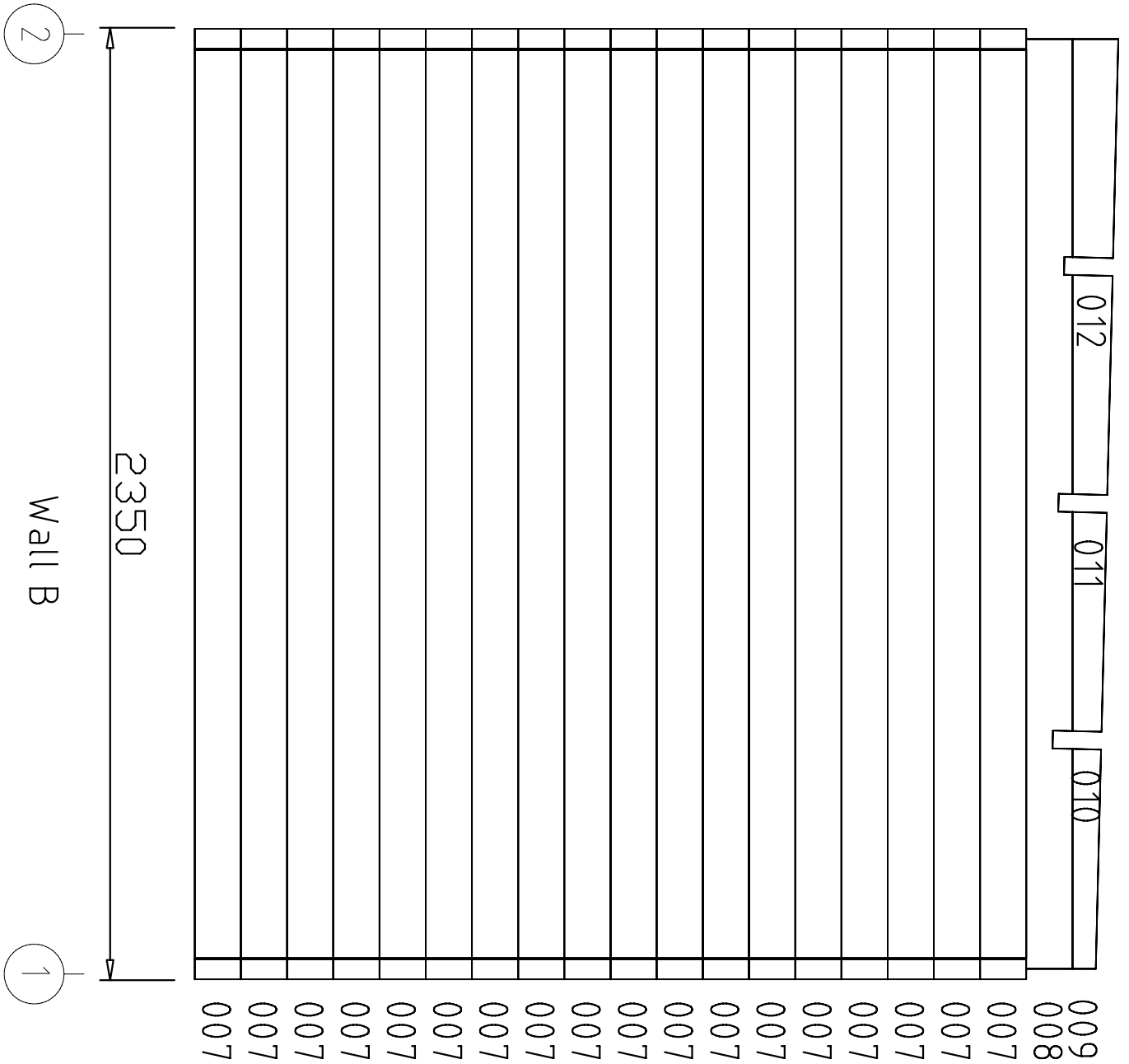

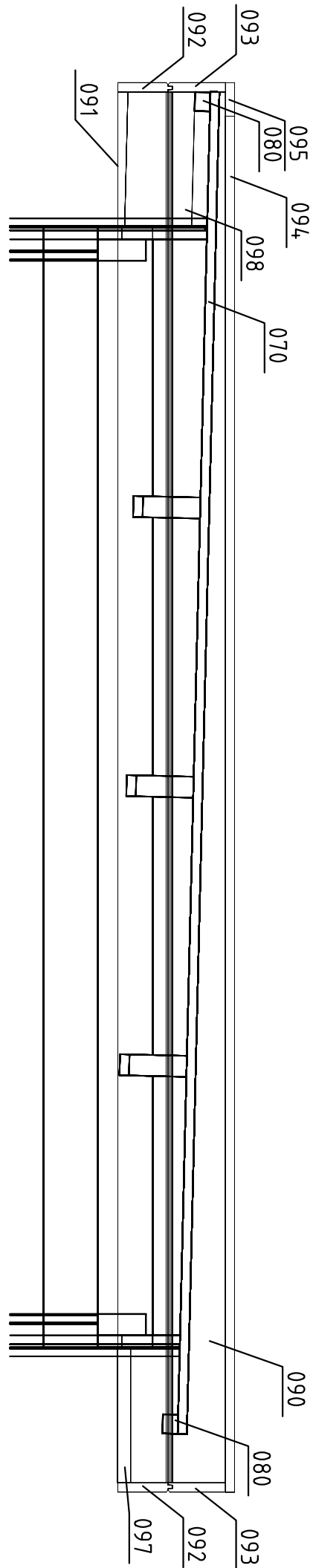

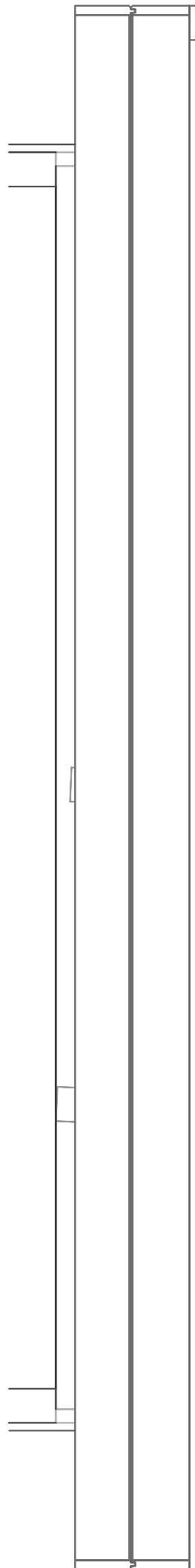



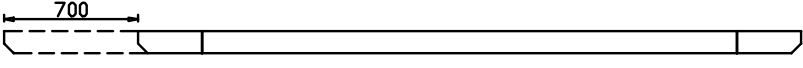
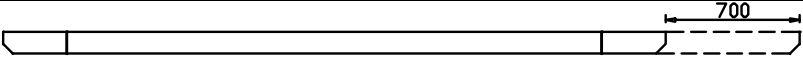
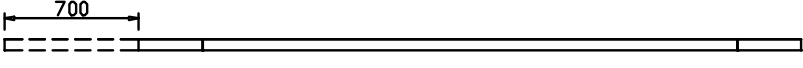
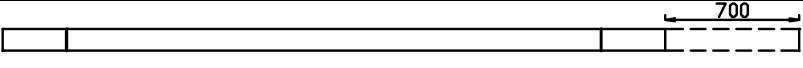
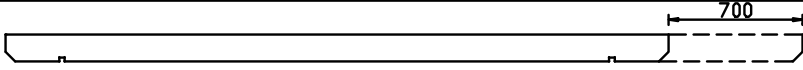



Pos	-FRB28-2924P-		Pcs	Profile (mm)	Length (mm)	Length (mm)
002(1)		700mm	1	28x114	<del>4162</del>	3462
002(2)		700mm	1	28x114	<del>4162</del>	3462
003		700mm	1	28x57	<del>4162</del>	3462
006		700mm	1	28x114	<del>4162</del>	3462
PR1		700mm	3	44x140	<del>4162</del>	3462
092	Eave edging- Dachrandbrett- Madrier en bordure du toit- Tavola bordo tetto- Tabla de voladizo 	700mm	2	105x19	<del>4200</del>	3500
093	Eave edging- Dachrandbrett- Madrier en bordure du toit- Tavola bordo tetto- Tabla de voladizo 	700mm	2	114x19	<del>4200</del>	3500
095	Covering board- Deckbrett- Madrier de couverture Tavola di copertura- Listón de cubierta 	700mm	1	70x19	<del>4200</del>	3500
080	Roof edge reinforcement- Dachrandleiste- Baguette en bordure du toit- Rinforzo bordo tetto- Refuerzo borde tejado 	700mm	2	32x40	<del>4162</del>	3462

