



**Universal ovens**  
**UNB 100-500**  
**UFB 400-500**



**Sterilisers**  
**SNB 100-400**  
**SFB 400-500**





**Incubators**  
**INB 200-500**

# Operating Instructions





1	Contents .....	3
2	General notes and safety notes .....	4
	2.1. Intended purpose when used as medical product .....	4
	2.2 Transport .....	4
3	Installation facilities (accessories).....	5
	3.1 Subframe (accessory).....	5
	3.2 Wall bracket (accessory) .....	5
	3.3 Stackable version (accessory) .....	5
	3.4 Initial start-up .....	6
	3.5 Oven load .....	6
4	Technical data.....	7
	4.1 Standard equipment of BASIC ovens.....	8
	4.2 Material quality .....	8
	4.3 Electrical equipment.....	9
	4.4 Supply failure .....	9
5	Oven construction and operation.....	10
	5.1 Operating the door .....	10
	5.2 Controls and indications.....	11
	5.3 Switching on.....	11
	5.4 Setting air changes.....	11
	5.5 Setting the temperature .....	11
6	Selecting the operating mode .....	12
7	Normal operation  .....	12
8	Timer operation  .....	13
9	Temperature monitor and protection devices.....	14
	9.1 Temperature limiter (TB) .....	14
	9.2 Monitor relay .....	14
10	Sterilisers .....	15
	10.1 Purpose definition for MEMMERT hot air sterilisers .....	15
	10.2 Note in accordance with Medical Products Guidelines.....	15
	10.3 Guidelines for sterilisation .....	15
	10.4 Steriliser cassettes.....	17
11	Cleaning.....	18
12	Maintenance .....	18
13	Error messages .....	19
14	CE Conformity Declaration .....	20
15	Address and customer service .....	23
16	Index.....	24

## 2 General notes and safety notes

You have purchased a technically fully proven product which has been produced in Germany with the use of high-grade materials and the application of the latest manufacturing techniques; it has been factory tested for many hours.

In addition we guarantee the supply of spare parts over 10 years.



This mark in the Operating Instructions means:

Watch out  
Important Note!



This mark on the product means:

Note Operating Instructions  
Warning – oven hot when operating!



Observation of the Operating Instructions is necessary for faultless operation and for any possible claims under warranty. If these Instructions are disregarded, all claims under warranty, guarantee and indemnification are excluded!

The right to technical modifications is reserved.

Dimensional details are not binding.

### 2.1. Intended purpose when used as medical product

For ovens covered by the scope of the Directive 93/42/EEG (Directive of the Commission on the harmonization of the legal regulations of the Member States on medical devices) the following intended purpose applies:

For ovens series SNB / SFB:

The product is intended for the sterilisation of medical products with dry heat using hot air at atmospheric pressure.

### 2.2 Transport

Always use gloves!

If the oven has to be carried, at least 2 persons are required to transport it.



Do not place the oven on a readily inflammable support surface!  
It is important that the oven is set up accurately horizontally!

### 3 Installation facilities (accessories)

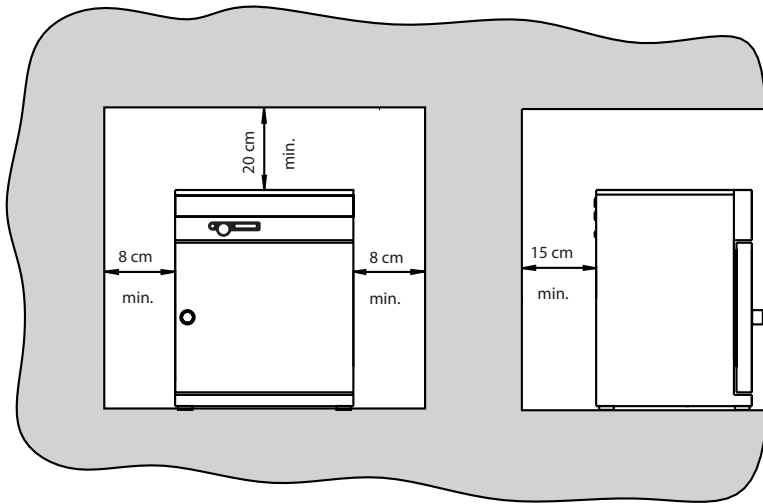

The oven can be placed on the floor or on a bench (working surface). It is important that the oven is set up accurately horizontally; the door may have to be adjusted (see Section „Maintenance“)

The spacing from the back of the oven to the wall should be at least 15 cm. The spacing to the ceiling must not be less than 20 cm and that at the side to the wall not less than 8 cm. Generally it is essential to have adequate air ventilation around the oven.

Information on accessories will be found in our leaflet or on our internet page [www.memmert.com](http://www.memmert.com). Please note the installation instructions for our accessories.

#### 3.1 Subframe (accessory)

Oven model 500 can be mounted on a subframe

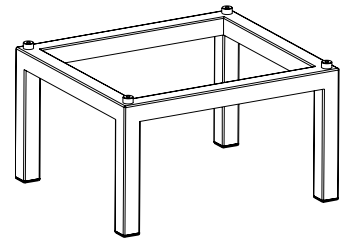

#### 3.2 Wall bracket (accessory)

Oven models 200 to 500 can be wall-mounted using the wall bracket. The wall bracket is factory-fitted with a fire-resistant plate. The size and length of the screws used and of the corresponding dowel plugs depend on the total weight (oven plus load) and vary with the condition of the wall.

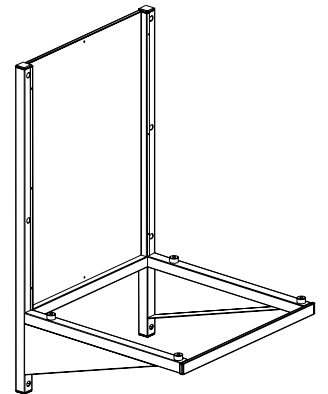

#### 3.3 Stackable version (accessory)

Two ovens of the same model size can be stacked on each other. Note that the oven with the lower working temperature must always be placed at the bottom.

Foot locators have to be fitted on the bottom oven.

- Take off cover of bottom oven
- Place drill jig (supplied with foot locators) into the inverted cover at the back
- Mark holes and drill 4.2 mm dia.
- Screw the foot locators to the top of the cover using the screws and nuts supplied
- Re-fit the cover

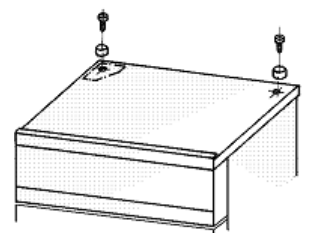
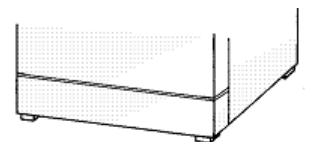

### 3.4 Initial start-up

When the oven is started up for the first time, it should be supervised continuously until steady conditions have been reached. Severe vibrations during transport may cause movement of the temperature probe in its holder inside the chamber. Note therefore that before the first start-up the temperature probe should be checked for its correct position and, if necessary, carefully aligned in its mounting (see ill).

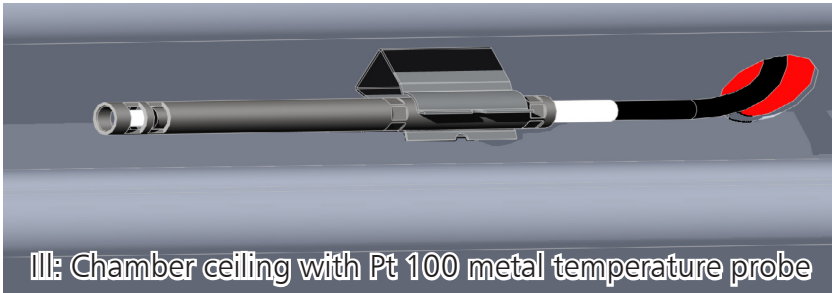

### 3.5 Oven load

Full consideration must be given to the physical and chemical properties of your load (e.g. combustion temperature etc.) in order to prevent serious damage to load, oven and surroundings.

Please note that the MEMMERT ovens described here are not explosionproof (they do not conform to the Industrial Association Specification VBG 24) and are therefore not suitable for drying, evaporating and burning-in of paints, enamels or similar materials whose solvents may produce an inflammable mixture with air. There must be no possibility of the formation of inflammable gas/air mixtures either within the oven chamber or in the immediate surroundings of the equipment.

Large amounts of dust or corrosive fumes inside the oven chamber or in the surroundings of the equipment may produce deposits within the oven and lead to short-circuits or damage the electronics. It is therefore important that adequate precautions are taken against excessive dust or corrosive fumes.

In order to ensure proper air circulation inside the chamber, there must be sufficient spacing of the load inside the oven. Do not place any load on the floor, against the side walls or underneath the ceiling of the chamber (heating ribs). In order to ensure optimum air circulation the shelves must be so inserted that the air spacings between door, shelf and rear chamber wall are approximately equal.

The maximum number and the loading of the shelves can be found in the [table in the Section „Technical Data“](#). With unfavourable loading (too closely spaced) and completely opened ventilation it is possible that the set temperature may be reached only after a longer period of time.

See stick-on label “Correct Loading” on the oven!

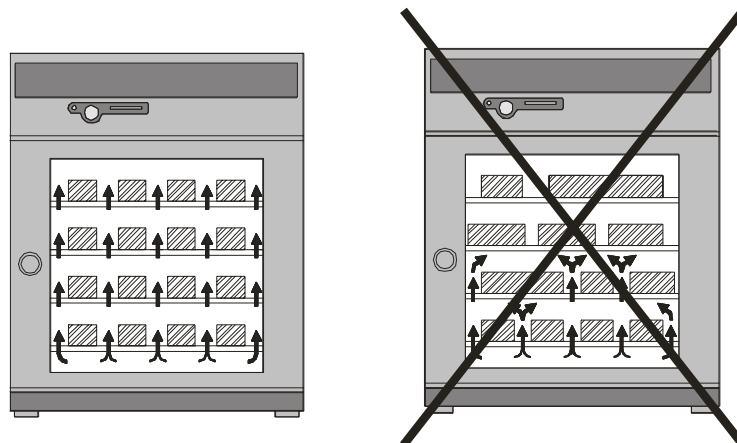

## 4 Technical data

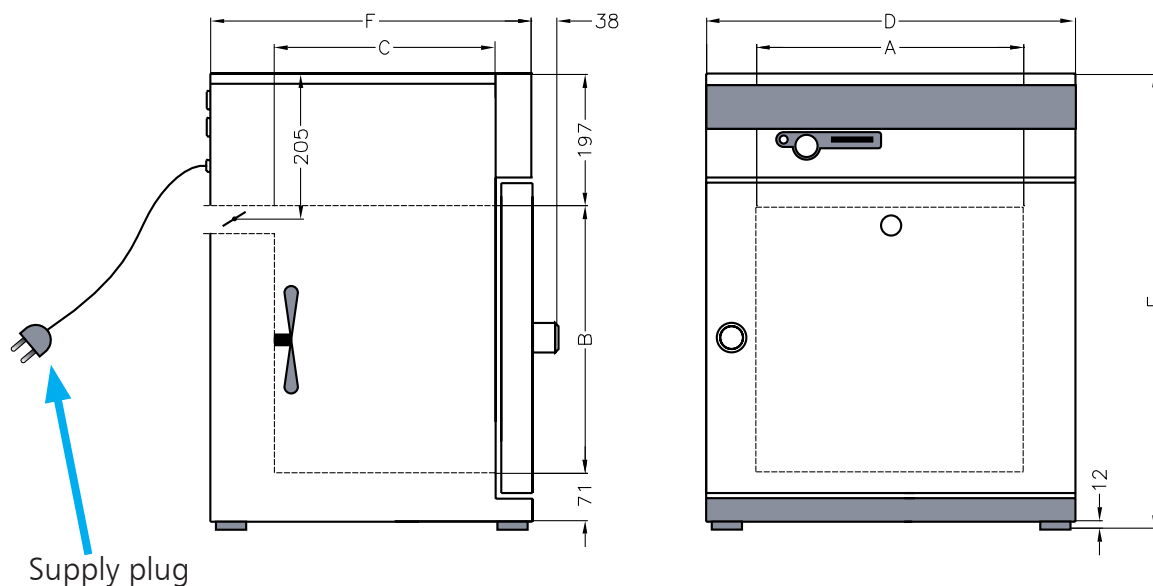

Model	100	200	300	400	500
Chamber width A [mm]	320	400	480	400	560
Chamber height B [mm]	240	320	320	400	480
Chamber depth C [mm]	175	250	250	330	400
Oven width D [mm]	470	550	630	550	710
Oven height E [mm]	520	600	600	680	760
Oven depth F [mm]	325	400	400	480	550
Chamber volume [litre]	14	32	39	53	108
Weight [kg]	20	28	30	35	50
Power, ovens UNB/UFB/SNB/SFB [W]	600	1100	1200	1400	2000
Power, ovens INB [W]	300	440	500	800	900
Max. number of trays	2	3	3	4	5
Max. load per tray [kg]	10	30	30	30	30
Total load per oven [kg]	20	30	30	90	60
Ambient conditions	Ambient temperature 5°C to 40°C rH 80% max., no condensation Overvoltage category: II Contamination level: 2				
Setpoint temperature range	20°C to nominal temperature (details see label)				
Setting accuracy	0,5°C				
Indication resolution	0,5°C				
Working temperature range	From 5°C above ambient temperature up to nominal temperature = maximum temperature (details see label) On ovens with fan (UFB/SFB) from 10°C above ambient temperature up to nominal temperature = maximum temperature (details see label)				

#### 4.1 Standard equipment of BASIC ovens

- Electronic PID controller with permanent power matching, auto-diagnostic system for rapid fault finding (see Section "Error messages")
- Manually adjustable air valve for recirculation or fresh air operation
- Programmable electronic switch-off timer up to 99 h 59 min
- Recessing push/turn control for simple operation of oven
- Visual alarm indication
- Monitor relay to switch off heating in case of fault
- Mechanical temperature limiter (TB Class 1)
- High-grade PT100 temperature sensor Class A in 4-wire circuit
- Special equipment (to be ordered separately as accessories): subframe, wall bracket, sterilisation cassette

#### 4.2 Material quality

For external housing MEMMERT employs stainless steel (Mat.Ref. 1.4016). The chamber is made from stainless steel (Mat.Ref. 1.4301) which exhibits high stability, optimum hygienic properties and corrosion resistance against many (not all) chemicals (warning against e.g. chlorine compounds).

The oven load has to be checked carefully for its chemical compatibility with the above materials. A compatibility table covering all these materials can be requested from MEMMERT.





**WARNING! Always pull out the supply plug before opening the oven cover!**

#### 4.3 Electrical equipment

- Operating voltage see label 50/60 Hz
- Current rating see label
- Protection Class 1, i.e. operating isolation with ground connection to EN 61 010
- Protection IP20 to EN 60 529
- Interference suppression to EN55011 Class B
- Oven protected by a fuse 250V/15A fast blow
- Controller protected by an 80 mA fuse (200 mA on 115 V)
- When connecting a MEMMERT oven to the electrical supply you have to observe any local regulations which apply (e.g. in Germany DIN VDE 0100 with FI protection circuit)

This product is intended to operate on a supply network with a system impedance  $Z_{max}$  at the transfer point (building connection) of 0.292 Ohm max. The user has to ensure that the product is only operated on an electrical supply network which meets these requirements. If necessary, details of the system impedance can be obtained from the local electricity supply authority.

#### Note:

**Any work involving opening up the oven must only be carried out by a suitably qualified electrician!**

#### 4.4 Supply failure

After a failure of the supply, operation is continued with the same parameter settings.

## 5 Oven construction and operation

Ovens Series UNB, INB and SNB have natural ventilation.

In Series UFB and SFB ovens, air circulation is provided by a fan on the back wall of the chamber.

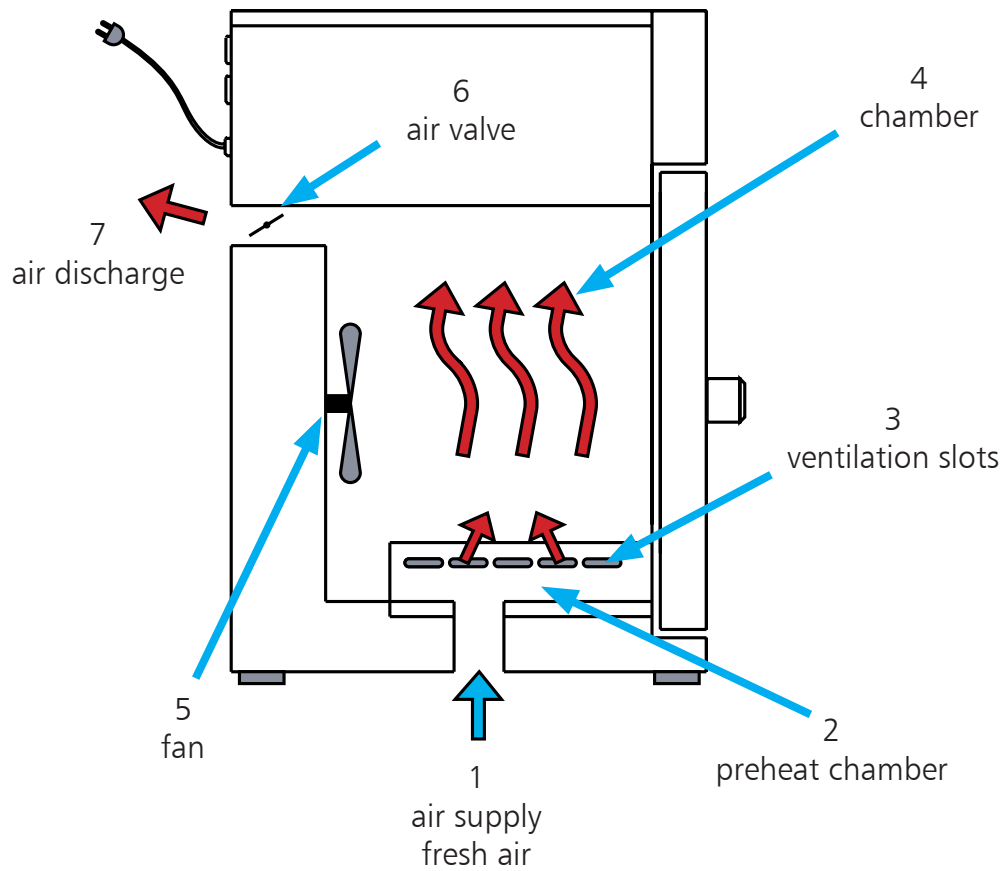

The incoming air (1) is warmed in a preheat chamber (2) in both convection and fan-circulation ovens. The preheated air enters the chamber (4) through ventilation slots (3) in the chamber side wall. The fan (5) on the chamber back wall produces a large air throughput and a more intensive horizontal forced circulation compared with natural convection. The air valve (6) on the back of the oven controls the rate of air intake and discharge (air change) (7).

### 5.1 Operating the door

The door is opened by pulling on the door handle. The door is closed by the door handle being pushed in.

close

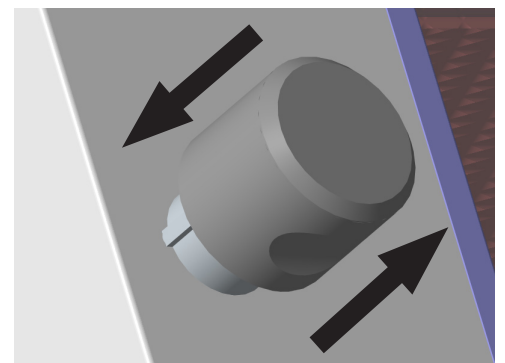

open

## 5.2 Controls and indications

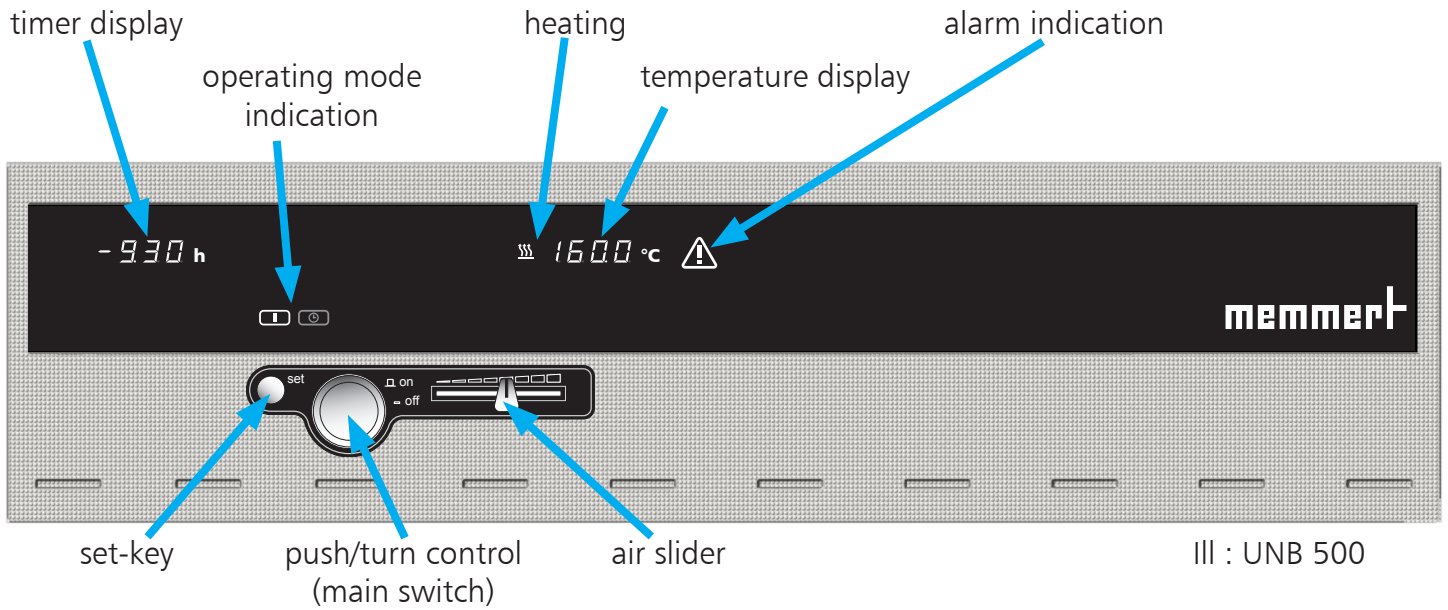

## 5.3 Switching on

The oven is switched on by pressing the push/turn control.

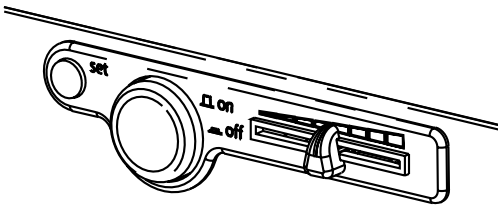

Oven switched off. The push/turn control is pushed in and protected against damage

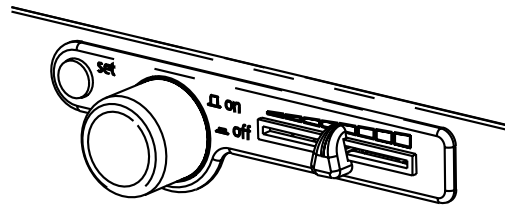

Oven switched on and can be operated using the push/turn control and the SET key.

## 5.4 Setting air changes

Moving the air slider opens and closes the air valve to control the supply and discharge of air.

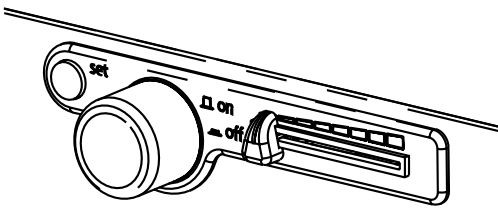

Air valve closed

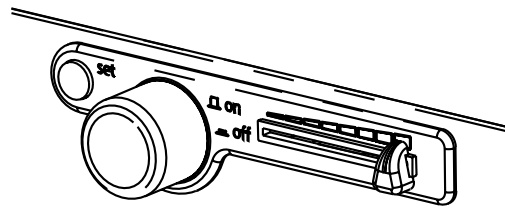

Air valve open

## 5.5 Setting the temperature

Hold down the SET key and set the temperature setpoint with the push/turn control.

After the SET key has been released the display briefly flashes the temperature setpoint. The display then changes to the actual current temperature and the controller starts to control to the selected temperature setpoint.

## 6 Selecting the operating mode

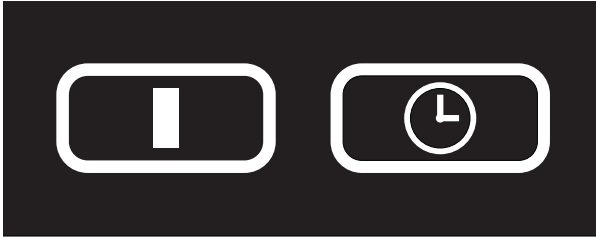

Normal  
operation

Timer  
operation

After holding down the SET key (approx. 3 sec), the current operating mode flashes on the display. A different operating mode can be selected with the push/turn control while the SET key is being held down. After the SET key has been released the controller operates in the new operating mode.

## 7 Normal operation

In this operating mode the oven operates continuously and heats and controls to the set temperature. On the ovens UFB/SFB the fan is running continuously.

Setting the temperature:

Hold down the SET key and set the required temperature setpoint with the push/turn control.

After the SET key has been released the display flashes briefly the temperature setpoint.

The display then changes to the actual current temperature and the controller starts to control to the selected temperature setpoint.

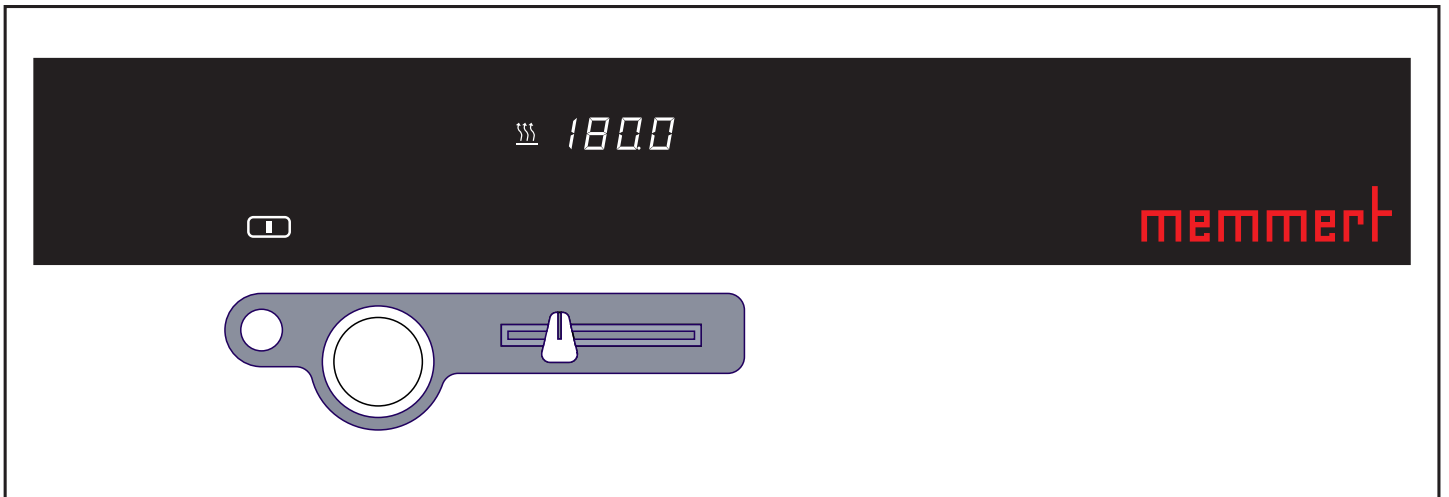

## 8 Timer operation

In this operating mode the oven operates on the timer; it heats/controls to the set temperature and maintains this temperature until the set time has elapsed. The clock symbol is flashing during timer operation, then the heating is switched off; on UFB/SFB ovens the fan runs on for 30 minutes. The timer display shows **END**.

- The time can always be set to **OFF**, the heating is then switched off and the timer display shows **END**.
- Time is counted down, it is always possible to see how long the oven will remain switched on.

Setting the temperature:

Turn the push/turn control clockwise until the temperature display is flashing.

Hold down the SET key and set the required temperature setpoint with the push/turn control.

After the SET key has been released the oven flashes briefly the temperature setpoint. The display then changes to the actual temperature and the controller starts to control to the selected temperature setpoint.

Setting the timer:

Turn the push/turn control anticlockwise until the timer display is flashing.

Hold down the SET key and set the required operating time with the push/turn control.

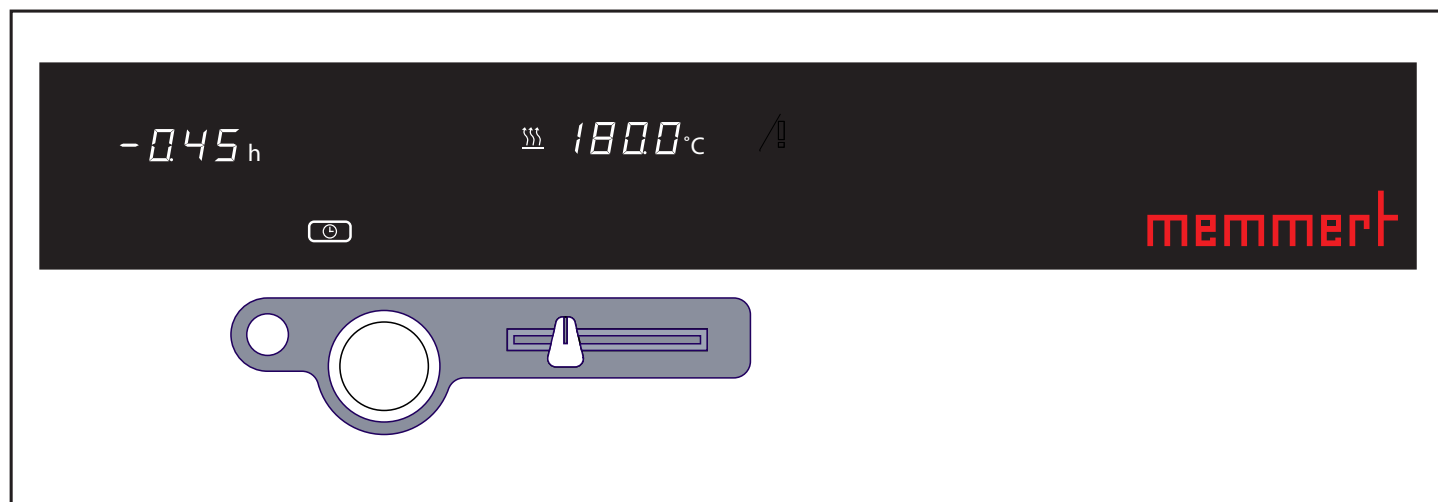

Example: the oven heats and controls at 180°C for 45 minute duration.  
(time is counted backwards)

## 9 Temperature monitor and protection devices

### 9.1 Temperature limiter (TB)

All ovens of the BASIC series are equipped with a mechanical temperature limiter (TB) Protection Class 1 to DIN 12 880.

If the electronic monitor system should fail during operation and the fixed factory-set maximum temperature is exceeded by approx. 20°C the temperature limiter switches off the heating permanently as a final protective measure. The alarm symbol lights up as warning.



Fault rectification after the TB cut-out has been activated:

1. Switch off the oven and allow it to cool down
2. Rectify the fault (e.g. replace temperature probe) and where appropriate contact customer service
3. The oven is again ready for operation only after it has cooled down and after the fault has been rectified.

### 9.2 Monitor relay

In addition to mechanical temperature protection the oven is provided with an electronic monitor relay.

If a fault occurs during operation or if the selected setpoint temperature is exceeded (by 3°C on ovens Series INB, by 10°C on ovens UNB/UFB/SNB/SFB) the monitor relay switches over the heating to this temperature in emergency mode. The alarm symbol is flashing as warning.

Fault rectification after the monitor relay may be activated:

Check the controller for error messages (see Section „Error messages“) and where appropriate contact customer service.

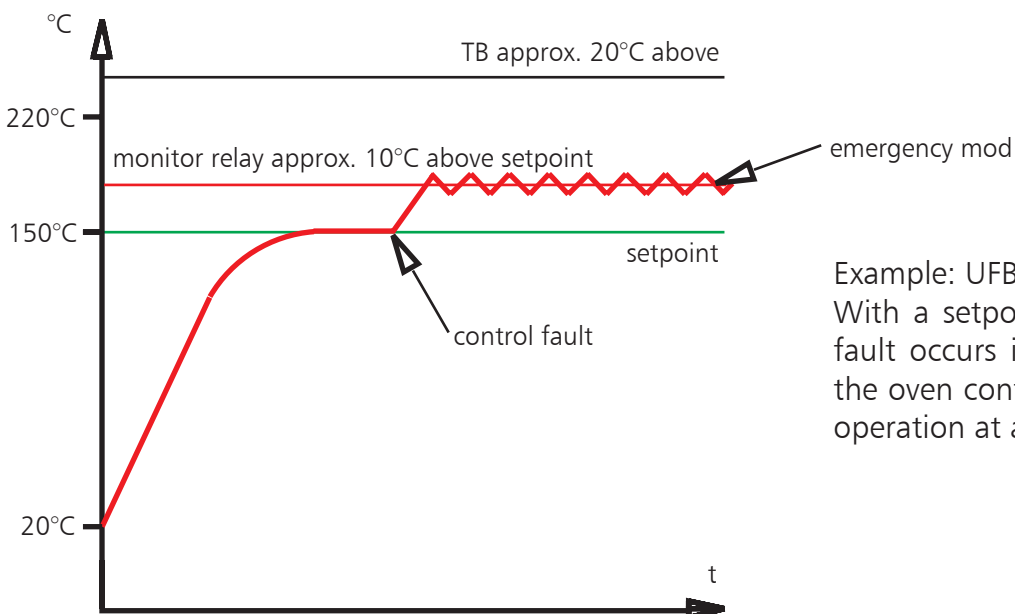

Example: UFB500:

With a setpoint temperature of 150°C, if a fault occurs in the power unit (faulty triac) the oven continues to operate in emergency operation at approx. 160°C.

## 10 Sterilisers

### 10.1 Purpose definition for MEMMERT hot air sterilisers

The oven SNB/SFB is intended for the sterilisation of medical materials by dry heat using hot air at atmospheric pressure.

### 10.2 Note in accordance with Medical Products Guidelines

The product lifetime specified by the manufacturer is 8 years.

### 10.3 Guidelines for sterilisation

For hot air sterilisation there are different regulations covering the temperature settings and the sterilisation times, as well as the packaging of the products to be sterilised. The values depend on the type and condition of the load to be sterilised and on the type of bacteria which have to be de-activated. Please make yourself familiar with the sterilisation method laid down for your application before carrying out sterilisation using your MEMMERT cabinet.

The operation of the MEMMERT hot air steriliser is also subject to the Standard DIN 58 947 Part 6.

A few examples of the correct preparation for different medical products are summarised in the following table:

Load	Preparation
Instruments (no soft solder)	load cleaned instruments, wrapped twice in aluminium foil or in steriliser foil suitable for hot air (recommended)
Cutting instruments	load cleaned instruments, wrapped twice in aluminium foil or in steriliser foil suitable for hot air (recommended)
Syringes (no plastics)	load plunger and cylinder separately, wrapped twice in aluminium foil or in steriliser foil suitable for hot air (recommended)
Glass and glass instruments	dismantle cleaned glass vessels and all-glass syringes and place into dishes, cool down slowly

Bottles, vessels and similar items must be sterilised without closure and with the opening downwards, in order to avoid the formation of cold air pockets. The recommended sterilisation temperature is usually 180°C (German Pharmacopoeia DAB 10)

The total sterilisation time to be selected consists of the heating-up time (i.e. the time until the desired temperature has been established within the entire steriliser chamber), the actual sterilisation time, and a safety margin.

The following table gives typical values for the total sterilisation time to be set, with different amounts of load, for sterilisers with and without fan. Please note that these values can be employed only with correct and loose distribution of the load. Notes on the correct loading of the steriliser can be found in these Operating Instructions and also on the label affixed to the steriliser. In case of unfavourable loading heating-up time could increase considerably.

Sterilisation temperature: 180°C	heating-up time + sterilisation time =					
	total sterilisation time					
	Type of loading:					
	light		medium		heavy	
Steriliser size	without fan	with fan	without fan	with fan	without fan	with fan
100	0:45 h + 0:45 h =  1:30 h	----	0:45 h + 1:15 h =  2:00 h	----	0:45 h + 1:45 h =  2:30 h	----
200	0:45 h + 0:50 h =  1:35 h	----	0:45 h + 1:20 h =  2:05 h	----	0:45 h + 1:50 h =  2:35 h	----
300	0:45 h + 0:50 h =  1:35 h	----	0:45 h + 1:20 h =  2:05 h	----	0:45 h + 1:50 h =  2:35 h	----
400	0:45 h + 1:15 h =  2:00 h	0:30 h + 1:00 h =  1:30 h	0:45 h + 1:50 h =  2:35 h	0:45 h + 1:20 h =  2:05 h	1:00 h + 2:00 h =  3:00 h	0:45 h + 1:50 h =  2:35 h
500	0:45 h + 1:15 h =  2:00 h	0:30 h + 1:00 h =  1:30 h	0:45 h + 1:50 h =  2:35 h	0:45 h + 1:20 h =  2:05 h	1:00 h + 2:00 h =  3:00 h	0:45 h + 1:50 h =  2:35 h

The sterilisation time is increased by a factor of 4 when sterilising at a temperature of 160°C. On large sterilisers and with heavy loading it is recommended to use wire shelves (special accessory) instead of perforated shelves.



Especially with heavy loading of the steriliser it is not sufficient to use these typical values without further tests. Reliable sterilisation requires validation of the individual sterilisation process, e.g. with the aid of additional temperature probes or by using biological or chemical indicators.

**Note:**

**In sterilisation processes the vent valve on the oven must be closed after the moist sterilisation load has been dried!**

10.4 Steriliser cassettes

The cassettes should preferably be so arranged in the steriliser that the hot air flow can pass readily through the air slots.

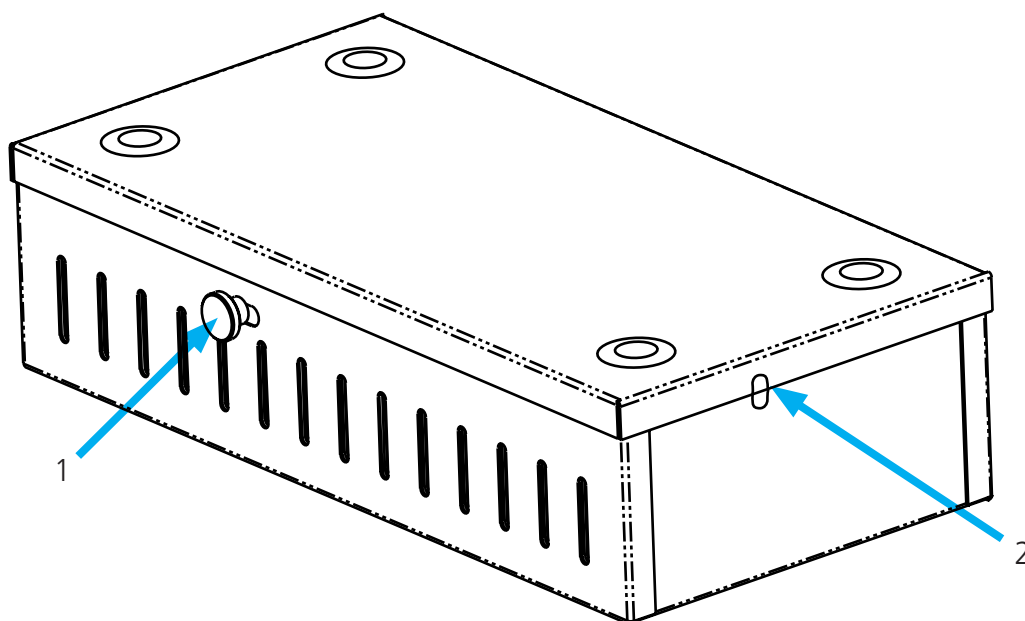

The load to be sterilised is placed into the steriliser cassettes wrapped in aluminium foil or in steriliser foil suitable for hot air (as in the Table in the Section „Guidelines for sterilising“). The air slots in the cassette must be open during sterilisation.

A temperature probe to confirm the temperature of the load can be introduced through the opening (2). After sterilisation has been completed the air slots must be closed by moving the slide knob (1). The sterilised and packed load can then be stored briefly in the closed cassette.

## 11 Cleaning

Regular cleaning of the easy-to-clean inside of the chamber prevents deposits which over time can detract from the appearance and the functionality of the stainless steel chamber .

The metal surfaces of the oven can be cleaned with commercially available cleaning agents for stainless steel. It is important to ensure that no rust-forming object comes into contact with the chamber or the stainless steel casing. Rust deposits cause infection of the stainless steel.

If any contamination causes rust stains on the surfaces of the chamber, such spots must be cleaned off immediately and the area polished.

The control panel, the plastic input modules and other plastic components of the oven must not be cleaned using scouring cleaning agents or those contained solvents.

## 12 Maintenance

Important for a long life of your MEMMERT product and in case of warranty claims.

### Note:

**Any work involving opening up the oven must only be carried out by a suitably qualified electrician!**

MEMMERT products require little maintenance. It is however recommended to lubricate all moving parts of the doors (hinges and closure) once a year (or 4 times a year with continuous operation) using a thin Silicone grease, and to check that the hinge screws are tight.

A well-closing door is essential on an oven. On Memmert ovens, tight closure of the door is ensured by a seal on the oven and another one on the door. In continuous operation the flexible sealing material may take a permanent set. Readjustment may then be necessary in order to ensure proper closing of the door.

- The top part (1) of the door hinge can, after releasing

bottom of the door, be moved slightly in the direction of the arrow.

- The door can be adjusted after releasing the socket screw (3) and rotating the excentric (4) by means of a screwdriver. NOTE ! Screw (3) is locked with locking varnish. It can be released by a sharp tug using a hexagon socket key. Apply more locking varnish to screw (3) and tighten it.

The closing panel (6) can also be adjusted in the direction of the arrow after releasing the screw (5). It is important that the panel is then screwed down firmly.

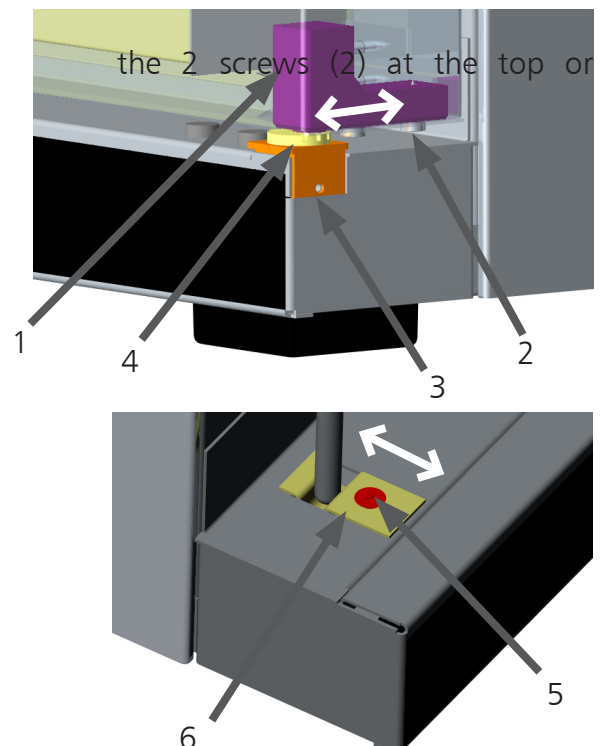

## 13 Error messages

- E-0 Error on self test
- E-1 Power module triac faulty
- E-2 Power module faulty
- E-3 PT100 temperature probe faulty

In case there is a fault on the oven, please get in touch with an authorised service organisation or contact the MEMMERT customer service department.

When dealing with the service department always quote the product serial number on the oven label.



## EC Declaration of Conformity

Manufacturer's name and address: MEMMERT GmbH + Co. KG  
Äußere Rittersbacher Straße 38  
D-91126 Schwabach

Product: Universal oven

Type: UNB ... / UFB ... / UNE ... / UFE ... / UNP ... / UFP ...

Sizes: 100 / 200 / 300 / 400 / 500 / 550 / 600 / 700 / 800

Nominal voltage: AC 230 V or 3 ~ AC 400 V 50 / 60 Hz  
alternative AC 115 V 50/60 Hz

---

The designated product is in conformity with the European EMC-Directive

**89/336/EEC**  
*including amendments*

**Council Directive of 03 May 1989 on the approximation of the laws of the Member States relating to electromagnetic compatibility.**

*Full compliance with the standards listed below proves the conformity of the designated product with the essential protection requirements of the above-mentioned EC Directive:*

DIN EN 61326:2004-05

EN 61326:1997  
EN 61326/A1:1998  
EN 61326/A2:2001  
EN 61326/A2:2003

---

The designated product is in conformity with the European Low Voltage Directive

**73/23/EEC**  
*including amendments*

**Council Directive on the approximation of the laws of the Member States relating to Electrical equipment for use within certain voltage limits.**

*Full compliance with the standards listed below proves the conformity of the designated product with the essential protection requirements of the above-mentioned EC Directive:*

DIN EN 61 010-1 (VDE 0411 part 1):2002-08  
DIN EN 61 010-2-010 (VDE 0411 part 2-010):2004-06

EN 61 010-1:2001  
EN 61 010-2-010:2003

---

Schwabach, 04.03.08

(Legally binding signature of the issuer)

**This declaration certifies compliance with the above mentioned directives but does not include a property assurance. The safety note given in the product documentation which are part of the supply, must be observed.**



**memmert**

## EC Declaration of Conformity

Manufacturer's name and address: MEMMERT GmbH + Co. KG  
Äußere Rittersbacher Straße 38  
D-91126 Schwabach

Product: Incubators  
Type: INB ... /INE ... / INP ...  
Sizes: 200 / 300 / 400 / 500 / 550 / 600 / 700 / 800  
Nominal voltage: AC 230 V 50/60 Hz  
alternative AC 115 V 50/60 Hz

---

The designated product is in conformity with the European EMC-Directive

**89/336/EEC**  
*including amendments*

**Council Directive of 03 May 1989 on the approximation of the laws of the Member States relating to electromagnetic compatibility.**

*Full compliance with the standards listed below proves the conformity of the designated product with the essential protection requirements of the above-mentioned EC Directive:*

DIN EN 61326:2004-05

EN 61326:1997  
EN 61326/A1:1998  
EN 61326/A2:2001  
EN 61326/A2:2003

---

The designated product is in conformity with the European Low Voltage Directive

**73/23/EEC**  
*including amendments*

**Council Directive on the approximation of the laws of the Member States relating to Electrical equipment for use within certain voltage limits.**

*Full compliance with the standards listed below proves the conformity of the designated product with the essential protection requirements of the above-mentioned EC Directive:*

DIN EN 61 010-1 (VDE 0411 part 1):2002-08  
DIN EN 61 010-2-010 (VDE 0411 part 2-010):2004-06

EN 61 010-1:2001  
EN 61 010-2-010:2003

---

Schwabach, 04.03.08

(Legally binding signature of the issuer)

**This declaration certifies compliance with the above mentioned directives but does not include a property assurance. The safety note given in the product documentation which are part of the supply, must be observed.**



## EC Declaration of Conformity

Manufacturer's name and address: MEMMERT GmbH + Co. KG  
Äußere Rittersbacher Straße 38  
D-91126 Schwabach

Product: Sterilisers

Type: SNB ... / SFB ... / SNE ... / SFE ... / SFP ...

Sizes: 100 / 200 / 300 / 400 / 500 / 550 / 600 / 700 / 800

Nominal voltage: AC 230 V or 3 ~ AC 400 V 50 / 60 Hz  
alternative AC 115 V 50/60 Hz

---

The product meets the regulations of the directive

**93/42/EEC**

***Directive of the council to adapt legal regulations of the member states on the subject of medical products dd. 14.06.1993 (Abl. EG Nr. L 169, S. 1, 12.07.1993) including annex and modifications.***

---

Schwabach, 25.02.08

(Legally binding signature of the issuer)

**This declaration certifies compliance with the above mentioned directives but does not include a property assurance. The safety note given in the product documentation which are part of the supply, must be observed.**

Standard ovens (UNB / UFB / INB) are safety-approved and bear the test marks:

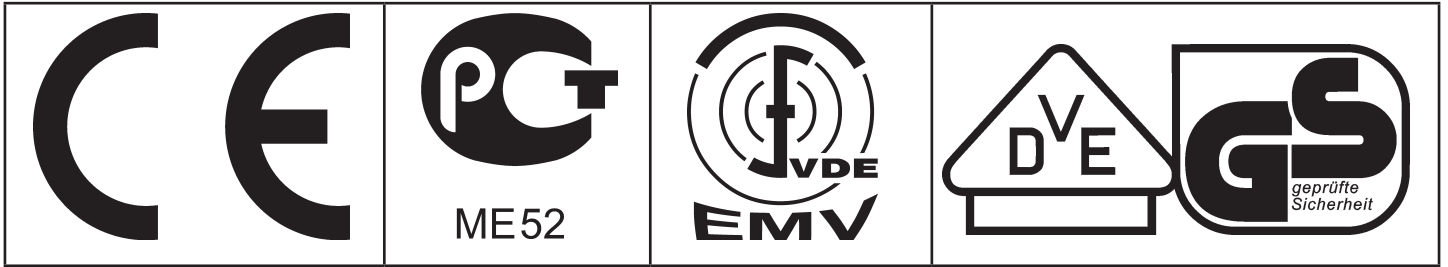

Sterilisers (SNB / SFB) are safety-approved and bear the test marks:

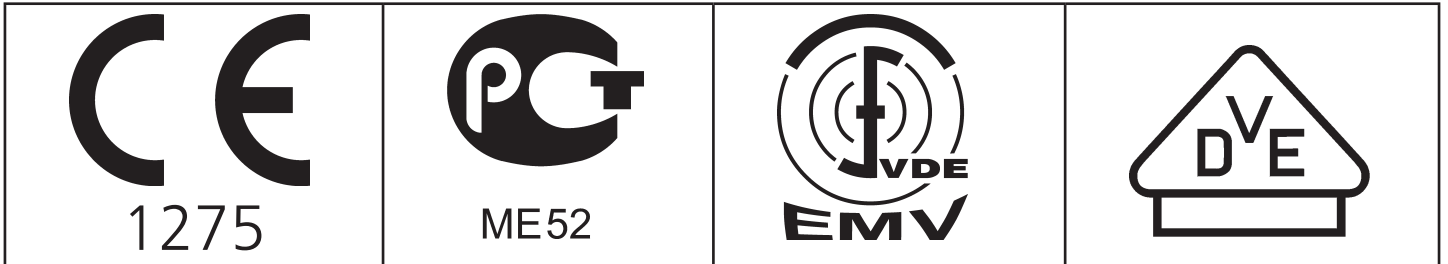

	<p>This product is subject to the Directive 2002/96/EC by the European Parliament and the EU Council of Ministers which concerns Waste Electrical and Electronic Equipment (WEEE). This product has been put on the market after 13 August 2005 in countries which have already incorporated this Directive into National Law. It should not be disposed off as part of domestic refuse. For disposal please contact your dealer or the manufacturer. Products which are infected, infectious or contaminated with health-endangering substances are excluded from return. Please note also all further regulations in this context.</p>
--	------------------------------------------------------------------------------------------------------------------------------------------------------------------------------------------------------------------------------------------------------------------------------------------------------------------------------------------------------------------------------------------------------------------------------------------------------------------------------------------------------------------------------------------------------------------------------------------------------------------------------------------

## 15 Address and customer service

MEMMERT GmbH+Co.KG  
 PO Box 17 20  
 91107 Schwabach  
 Germany  
 Phone: 00 49 9122 / 925-0  
 Fax: 00 49 9122 / 14585  
 E-mail: sales@memmert.com  
 Internet: www.memmert.com

Customer service:  
 Phone: 00 49 9122 / 925-143  
 or 00 49 9122 / 925-126  
 E-mail: service@memmert.com



When contacting customer service, always quote the product serial number on the oven label.

## 16 Index

### A

accessories 9  
address 23  
air changes 11  
air slider 11  
air supply 10  
air valve 10  
alarm indication 11  
alarm symbol 14

### C

CE conformity declaration 20  
cleaning 18  
construction, oven 10  
customer service 23

### D

DIN 12 880 14  
display, temperature 11  
display, timer 11  
door 10  
door handle 10

### E

error messages 19

### F

failure, supply 8, 19  
fan 10  
fan indication 11

### I

initial start-up 5  
installation facilities 9

### L

limiter, temperature 14  
load 5

### M

main switch 11  
maintenance 18  
material quality 4, 7  
medical product 4  
monitor relay 14

### N

normal operation 12

### O

operating mode indication 11  
operating mode selection 12  
operating time 13  
operation 10

### P

Protection Class 1 14  
protection devices 14  
purpose, intended 4, 15  
push/turn control 11

### R

relay, monitor 14

### S

safety notes 4  
SET key 11, 12, 13  
stacking 9  
start-up, initial 5  
steriliser cassettes 17  
sterilisers 15  
subframe 9  
supply failure 8, 19

### T

TB 14  
temperature 11  
temperature display 11  
temperature limiter 14  
temperature monitor 14  
temperature probe 5  
temperature setpoint 11  
timer display 11  
timer operation 13  
transport 4, 5

### W

wall bracket 9









15.05.2008  
BASIC englisch

D09803