

metos

UNDER COUNTER TOP INDUCTION

Incogneeto

Installation and user manual



27.11.2014

MG4231590

TABLE OF CONTENTS

1.	General Information	3
1.1.	Model Types	3
1.2.	User Interface Buttons	3
2.	Preparing the appliance for use	4
2.1.	Before operation.....	4
2.2.	Grounding Instructions:	4
3.	Electrical installation requirements	4
4.	Mechanical installation	4
5.	General Operation	5
5.1.	Control Configuration	5
5.2.	General Operation	5
5.2.1.	Change Temperature Scale (F/C)	6
5.2.2.	Change Temperature Options (Short/Long)	6
5.2.3.	Programming a Magneeto™ II	6
5.2.4.	Magneeto™ II Operation (607700, MGRFID02).....	6
5.3.	Important Information	8
5.4.	Important Safety Precautions.....	8
5.5.	Care and Cleaning	9
5.5.1.	Incogneeto™ Buffet.....	9
5.5.2.	Magneeto™ II (607700, MGRFID02).....	9
6.	Warranty Statement	9
7.	Trouble Shooting	10
8.	Error Code Table	11
9.	Installation	12
10.	Technical specifications	15

1. General Information

1.1. Model Types

MB061-U – 120 Volt Model

MB062-U – 240 Volt Model

1.2. User Interface Buttons

Power Button



Use this button to turn the unit on and off, a green LED will indicate when the unit is on.

Lock Button



Use this button to prevent users from adjusting settings. Pressing this button three times will lock the unit. When the unit is locked the only button that will continue to work is the Power Button. To unlock the unit press the lock button three times. The red LED to the right of the button will indicate when the unit is locked.

Up and Down arrows



These buttons allow you to quickly set the temperature.

Alphanumeric display



Displays cooking temperature (Fahrenheit or Celsius) and error code information.

2. Preparing the appliance for use

2.1. Before operation



Before operating your buffet, do the following:

- Remove all packing material and save for subsequent shipment or in case of concealed shipping damage.
- Keep unit away from other heat sources and allow at least two (2) inches clearance for air circulation at sides, front and rear of the unit. If either the air intake or exhaust outlet is blocked, the internal temperature will rise, causing an error code to occur.

2.2. Grounding Instructions:

The buffet must be properly grounded. In the event of an electrical short circuit, grounding reduces the risk of electric shock by providing a safe path for the electric current. The buffet has a power cord with a 3-prong grounding plug, which must be used in a compatible and properly grounded outlet. It is the owner's responsibility to replace any 2-prong wall outlet with a properly grounded 3-prong wall receptacle.

For your safety, never cut, remove, or disable the electrical (ground) connection from the plug. Never use an adapter plug or an extension cord with the buffet.



WARNING: Electric shock can result from an improperly grounded plug. Please consult a qualified electrician if you have any questions about these grounding instructions.

Before you begin:

Please make sure that this power cord is firmly attached to your CookTek unit BEFORE plugging the unit into the power receptacle and before attempting operation

3. Electrical installation requirements



Every installation site has different electrical wiring. Because many different local codes exist, it is the Owner and Installer's responsibility to comply with those codes. CookTek is not responsible for any consequential damages as a result of failure to comply with installation requirements.

- Read all installation instructions carefully before starting installation.
- Remove buffet carefully from carton.
- Remove all loose packaging and accessories and save for subsequent shipment or in case of concealed shipping damage.
- It is the responsibility of the installer to comply with all federal, state and local codes.
- Any installation not matching the specifications discussed in this manual automatically voids the product's warranty.

4. Mechanical installation

- Install the mounting tracks per the installation sheet provided with either the single unit tracks or the rail kit as appropriate. Also see instructions at the end of this manual



- Insert the unit with the **Antenna side sticker away from the customer.** This is the side of the unit that the Magneeto™ II tag must be positioned over.
- To install the unit on the tracks hook one side of the springs on to the track and then compress the other side of the mounting springs and snap it into the track. See assembly drawing

5. General Operation

Plug the Buffet into a grounded, single-phase receptacle. Models will run on 100-130V drawing up to 650W, or on 200-240V drawing a maximum of 650W. Check rating plate on unit to verify correct voltage and wattage. Voltages below 120V or 240V can result in less than rated power and slower heating times. This appliance is designed for holding food products only.



This unit is equipped with SmarTag™ technology, using RFID to provide precise temperature control. The unit requires a Magneeto™ II for operation. The Incogneeto™ unit will not work with a Magneeto™ I module or a RFID equipped chaffing dish.

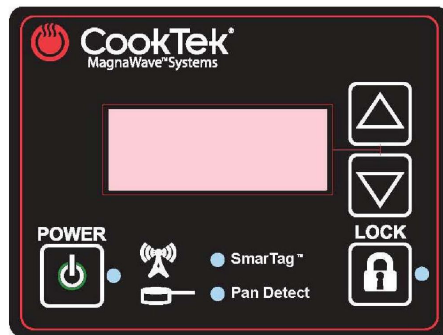

NOTE: For proper operation, an independent, dedicated circuit should be used for up to 3 units installed on a 15 amp (120V) circuit, 4 units installed on a 20 amp circuit (120V), or up to 5 units installed on a 20amp (240V) circuit.

5.1. Control Configuration



5.2. General Operation



- Press  (power button) to turn the unit on, the green LED next to the power button will illuminate.
- Place a Magneeto™ II on the counter top and position it over top of the unit until the LED begins flashing and the  (SmartTag) LED will light up
- Place an induction compatible dish on the top of the Magneeto™ the  (Pan Detect) LED will illuminate, make sure the dish is centered on the Magneeto™ II The unit will start at





80 degrees, or the last entered temperature. Press  (up and down arrows) to select desired temperature selecting from the preset choices.

- Fahrenheit Settings (80-190 degrees): 80, 150,160,165,170,175,180,185,190
- Celsius settings (30-85 degrees): 30,40,50,60,65,70,75,80,85

- Once you have chosen your preferred temperature the unit will begin to heat the dish. The letter F or C will flash when the dish is heating. When the dish has reached the set temperature the letter F or C will remain solid on the display





- To lock the controls press    (lock button) three times (the red LED to the right of the lock button will illuminate to indicate the unit is locked). This will prevent temperature settings from being changed. The Power button will continue to function while locked. To unlock the controls press the lock button three more times.







- When you are finished using the unit press  (power button), the green Power LED will go out. Remove the dish from the unit.





5.2.1. Change Temperature Scale (F/C)

- Starting with the unit off, hold down  (up arrow) while pressing  (power on button). Then use the down arrow to select the desired scale. Powering the unit off completes the selection.
 - Note: If a button is not pressed for more than five minutes the unit will power off keeping the previously set temperature scale.

5.2.2. Change Temperature Options (Short/Long)

- Starting with the unit off, hold down both   (up and down arrows) and press  (power button). Use the arrows to select "NUM" and press  (lock button). Use the arrows again to select "PART" or "FULL" for the partial or full set of temperatures. Press  (power button) to set the value.

5.2.3. Programming a Magneeto™ II

- Starting with the unit off, hold down  (Down arrow) while pressing  (power on button).
- The display will start with the text "CLR," use this to clear the tag (the unit will no longer enter auto mode). Otherwise use the up and down arrows to select a temperature
- To Set the tag press   (Lock Twice). The display will read "Tag Set"
- Repeat if necessary with other Magneeto™ II s.

5.2.4. Magneeto™ II Operation (607700, MGRFID02)

- With Incogneeto™ or MB061 unit turned on, place Magneeto™ II on counter top in expected vicinity of unit. (Ribbed side down) Slowly slide the Magneeto™ II around until the red light flashes.
- Placement where the light flashes brightest is the optimum position.
- Place dish on top of Magneeto™ II for warming. (do not cover the RFID tab with the dish) (Locating may also be performed with the dish already on the Magneto II.)

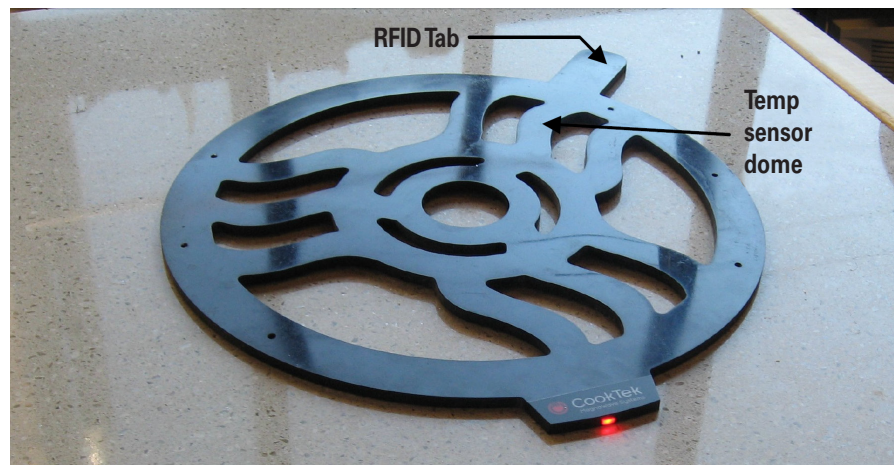

For larger pans

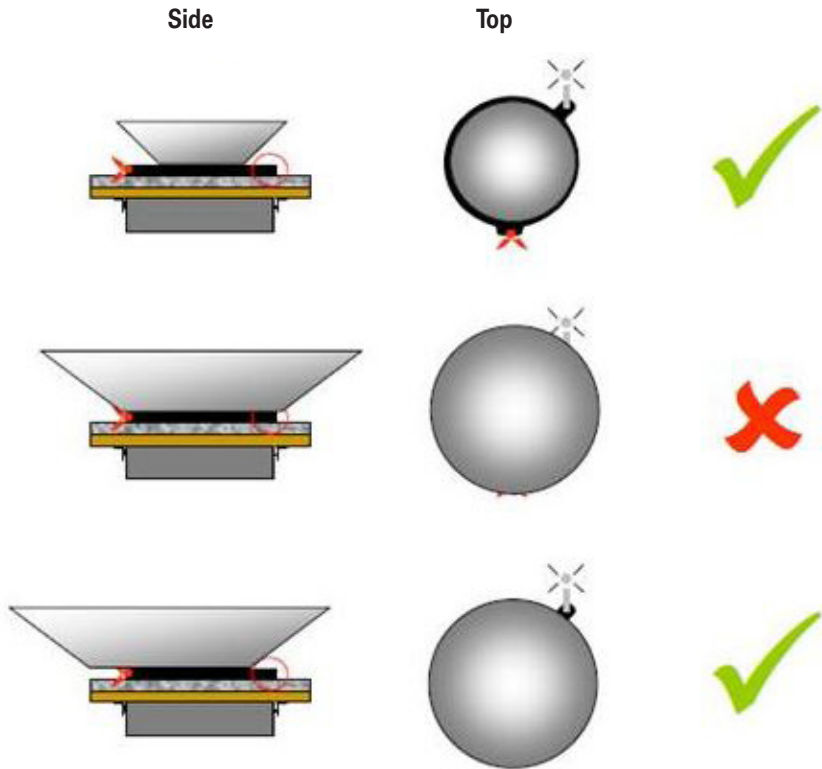

The Magneeto 2 Wireless Communicator Tab must not be covered by the dish. This will prevent proper communications.

If a large pan must be used, then it is OK to cover the red LED, but NOT the wireless communicator tab.

For smaller pans

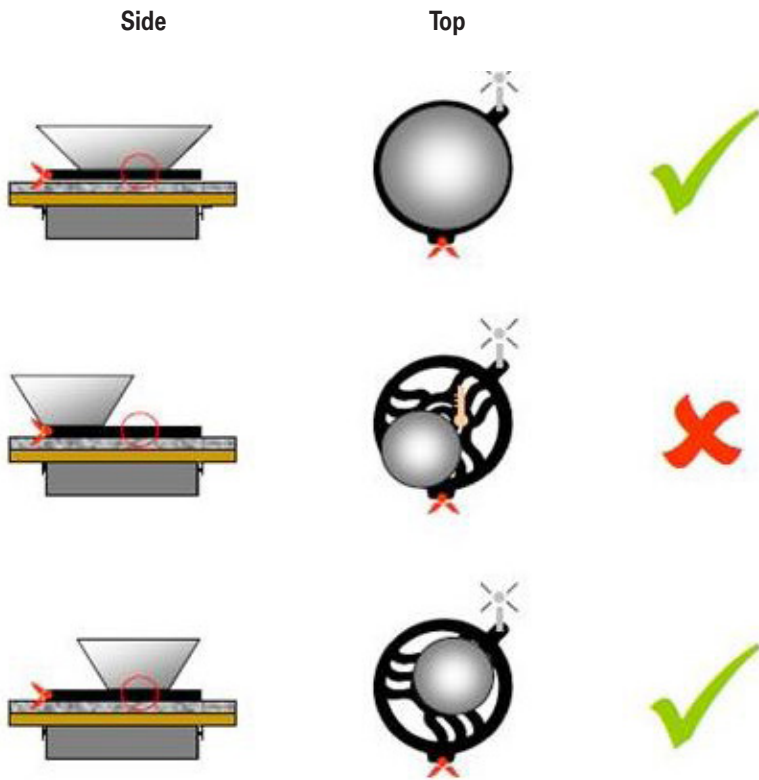

The pan must be in contact with the Temperature Sensor. Overheating the pan can result, which may cause terminal damage to the Magneeto 2.

If a small pan must be used, then it must be in contact with the Temperature Sensor

5.3. Important Information

- Never heat an empty pan. It may damage the Buffet or cookware and overheat the unit. When over-heating occurs, an error code will flash on the display and the Buffet will shut itself off automatically. When the internal temperature returns to normal, the Buffet can be used again.
- Remember to turn the Buffet off after each use.
- Keep the Buffet away from gas and electric ranges or open flames. Do not place in the oven. If the ambient air temperature is above 110 degrees F the Buffet may not function properly.
- Be sure to dry off the outside of the pan before use. Water droplets on the outside of the pan may begin to boil and spatter as the pan temperature rises.
- Do not use aluminum foil on top of the Buffet.
- Do not use the Buffet near a faucet, swimming pool, sink, or other areas where water can be found.
- Never store the Buffet outside or upside down.
- Do not obstruct, block, or alter the air entrance or outlet. Do not stick foreign objects into these openings.
- Do not strike or damage the Buffet. Do not put the Buffet in your luggage. Throwing or dropping the Buffet can damage the internal components or crack the Buffet, voiding your Warranty. If the Buffet becomes cracked, unplug.

5.4. Important Safety Precautions

- To reduce the risk of fire, electric shock, or injury - please read, follow and save all instructions.
- Never immerse cords, plugs or appliance in water.
- Supervise carefully when appliance is used near children. Keep children away from appliance when in operation.
- Always unplug appliance immediately after use and allow for cooling time if handling, transporting, or storing.
- Do not use any appliance that has a damaged cord or plug, or one that has malfunctioned or been damaged. Consult the warranty and follow instructions for service.
- Do not use any accessories or attachments that are not recommended by the manufacturer. Use of unapproved accessories may cause injuries and void the warranty.
- The pan on the appliance will heat continuously as long as the power is ON. The pan will be hot and caution should be exercised when working on or near the appliance.
- Do not let the power cord touch hot surfaces or hang over the edge of the counter. Do not move the appliance when electric power is connected. Do not move the appliance while a hot pan or pan containing hot liquids is on top of the appliance.
- To disconnect appliance, press the Power button and wait for LED to no longer be illuminated. You may then remove the plug from the outlet.
- Do not use CookTek Buffet for anything other than its intended use as described in this manual. This unit is designed to heat food and is not intended for laboratory or industrial use.
- Do not put food or unopened cans on the Buffet surface.
- This product may only be serviced by an authorized service agent or by CookTek personnel. Do not attempt to open the unit or perform service of any kind. For service information contact service
- This appliance must be grounded. Connect only to a properly grounded outlet. Before operating, read grounding instructions and Electrical Installation Requirements on Page 2 of this booklet. Do not use an extension cord.
- Do not overcook food or leave appliance unattended while in use.
- In the unlikely event of a grease fire, smother flame by covering pan with a tight-fitting lid, cookie sheet, or flat tray.
- DO NOT USE WATER. When the fire is under control, turn off appliance and unplug from wall.
- Use only with induction-compatible and efficient cookware.
- Place Buffet on a level, hard, stable, non-flammable surface before use.

5.5. Care and Cleaning

5.5.1. Incogneeto™ Buffet

Your CookTek Induction Buffet is easy to keep clean. Be sure to follow these easy instructions:

- Turn the unit OFF and remove the plug from any power outlets prior to cleaning.
- Never immerse the Buffet in water or put it in the dishwasher.

5.5.2. Magneeto™ II (607700, MGRFID02)

Cleaning

- When needed, clean the Magneeto™ II with a mild soap or detergent.

Care and Cautions

- The induction unit RFID antenna is located in the back of the unit. The Magneeto™ II RFID tab must be positioned over the antenna.
- Use the Magneeto™ II ONLY with Incogneeto™ and MB061 series 650 watt RFID induction units. DO NOT use the Magneeto™ II with any other induction appliance, as it may be damaged.
- Maximum dish/pan bottom size is 12" in diameter. The dish/pan bottom must be flat and in contact with the temperature sensor dome or overheating will result.
- Some upward bowing of the Magneeto™ II when hot and a dish is removed is normal and will disappear with cooling or when a dish is placed on top.
- Do not significantly bend or twist the Magneeto™ II, as damage may result.

→ Control Boxes Are NOT Water Tight ←

- Clean with a soft damp cloth only
- CAUTION – Excessive water will cause failures



- Do not power wash
- Do not hose down
- Do not use excessive water when cleaning



6. Warranty Statement

This warranty is void if it is determined that upon inspection by an authorized service agent that the equipment has been modified, misused, misapplied, improperly installed, or damaged in transit or by fire, flood or act of God. Warranty will be considered void if the serial nameplate has been removed or if the unit has been opened or modified in any way, or service has been attempted by unauthorized personnel. IMPORTANT! Keep a copy of your sales receipt to verify date of purchase. A valid proof of purchase, indicating Serial Number(s) and date of purchase is required to obtain Warranty Service. The prices charged by CookTek for its products are based upon the limitations in this warranty. Seller's obligation under this warranty is limited to the repair of covered defects without charge by a CookTek factory authorized service agent or one of its sub-service agencies.

7. Trouble Shooting

Symptom	Probable Cause	Possible Solution
No Power (No Lights or Fan Noise)	Unit Unplugged	Plug Unit into Appropriate Receptacle
	No Power to Receptacle	Make Sure that Receptacle is Energized
	No Power to Receptacle	Check Wall Switches
	No Power to Receptacle	Check Circuit Breaker
	No Power to Receptacle	Plug a different electronic device into the receptacle to make sure that power is present
Pan Does Not Heat	Pan is Not Induction Efficient	Use Induction Efficient Pan
	Pan Not Centered	Center Pan
Buffet Suddenly Stops Heating	Possible Power Brown Out	Assure proper voltage/power
	Circuit Shared with another Electrical	Make sure that the Cook top is not sharing a circuit with other Electrical Devices
	Safety Shut-Off Engaged	The Safety Shut-Off will engage if an empty pan is left on the Cook top surface while the unit is working at full power. Make sure that the Cook top surface is clear. Wait 15-20 minutes for the unit to reset.
Pan Does Not Get Hot Enough Even Though Power Levels Are Set To Maximum- Induction Efficient Pan In Use	Extension Cord In Use	Do Not use extension cords. Extension cords may affect the power levels reaching the appliance
	Circuit Shared with Another Electrical Device	Make sure that the Cook top is not sharing a circuit with other Electrical Devices
Pan heats Unevenly. Does Not maintain Heat Level, or Overheats	Pan is Not Induction Efficient	Use Induction Efficient Pan
	Bottom May Not Be Flat	Use Flatter Pan
	Pan Not Centered C	enter Pan
	Pan Diameter is Less than 7 inches	Use a larger Induction Efficient Pan

8. Error Code Table

In the event of a Possible Malfunction, your CookTek MagnaWave™ Buffet will display an Error code on the alphanumeric display. The some models will beep a specific number of times indicated by the error and flash the lights on the control box.

Please consult the following table when encountering an Error Code.



To reset error conditions remove the pan from the unit and press  (Power button) or unplug the unit.

Error	Error Cause	Displayed Message	Troubleshooting
1	Broken Temperature Sensor	E-01	ervice required
3	Over current (peak)	E-03	Try different cookware. Service may be required.
6	High line voltage	E-06	To reset, unplug unit, wait 5 seconds, and plug in again. If problem persists, have an electrician monitor the line voltage.
7	Harware failure	E-07	Service required.
8	Zero cross failure	E-08	Turn unit off, then on. Plug unit into outlet on different circuit breaker. If problem persists, service is required on device
10	Magneeto™II RTD Failure	E-10	Magneeto™II needs repair. Service needed for Magneeto™ II.
11	Tag communication	E-11	Ensure the RFID tag on the pan is properly located.
12	RFID reader failure	E-12	Service required.
13	User interface error	E-13	Check control panel connection, cycle power. Service required
16	Critical error	E-16	Call dealer for service. Service required.

9. Installation

- Internal cooling fan displaces 70 CFM (2.0m³/min). Adequate cabinet venting should be provided - typically 16in² (100cm²) per unit. The maximum (do not exceed) ambient temperature is 50°C/122°F.
- Cooling clearance: 6" (152mm) below
- Thickness of stone (countertop) + Thickness of wood substrate = Combined thickness of stone/wood substrate (this measurement should be 30-40mm)

Rail system conversions: 1.18 inches = 30mm Match total thickness to
 1.26 inches = 32mm closest rail setting and install
 1.57 inches = 40mm locknuts

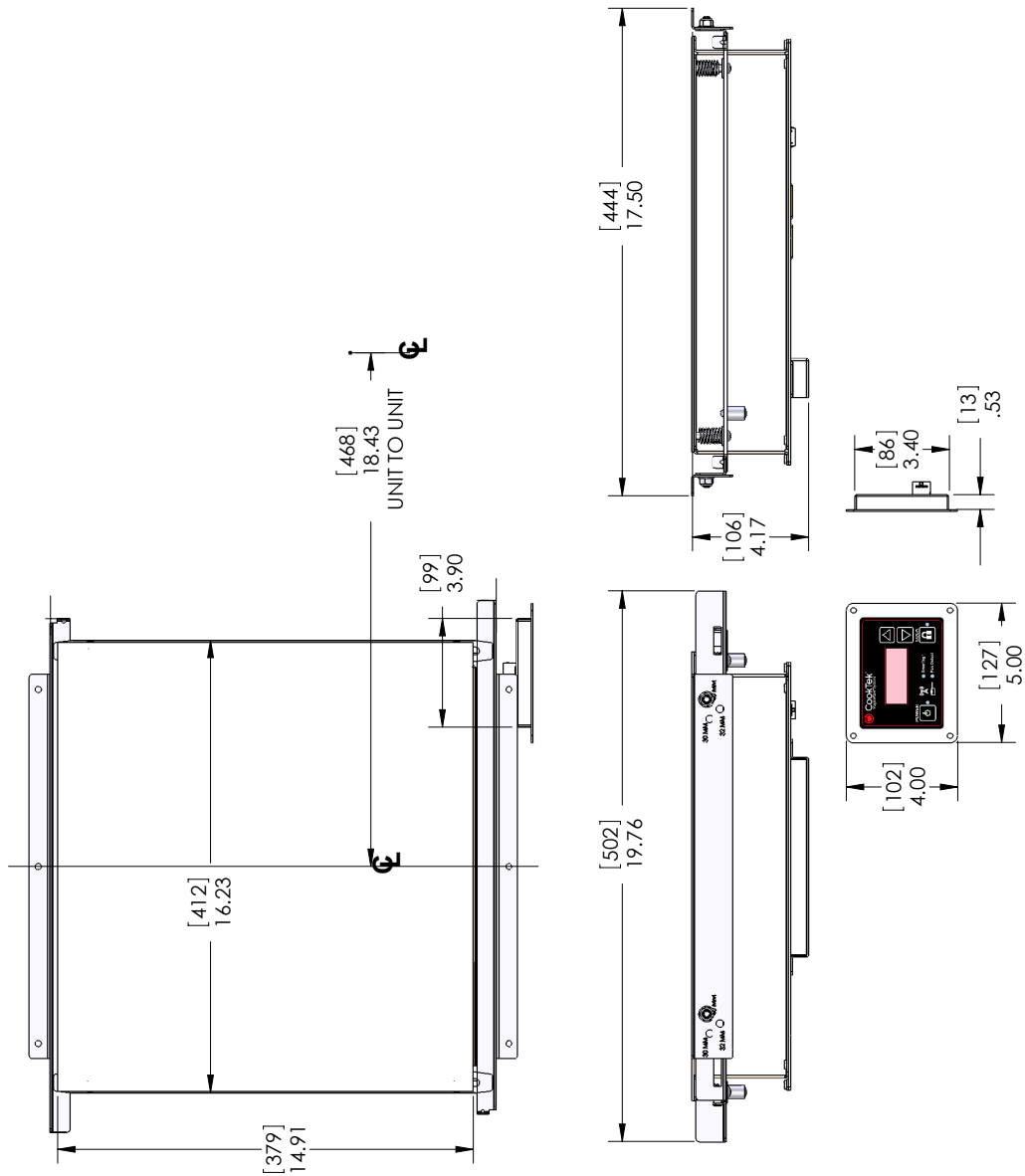

**INSTALLATION FOR 20mm GRANITE
WITH 20 mm OR 12 mm WOOD SUBSTRATE**

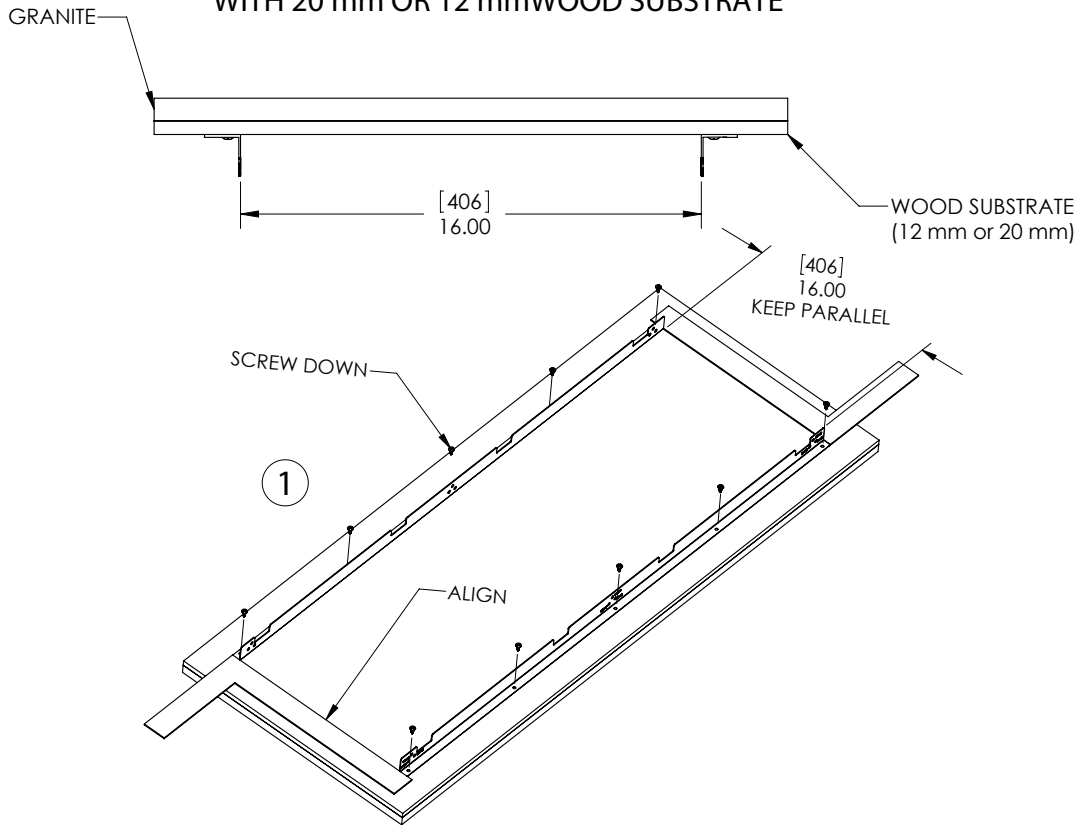

2 ADJUST BRACKET FOR DESIRED COUNTER TOP THICKNESS

40mm (nominal)
COUNTER THICKNESS

32mm (nominal)
COUNTER THICKNESS

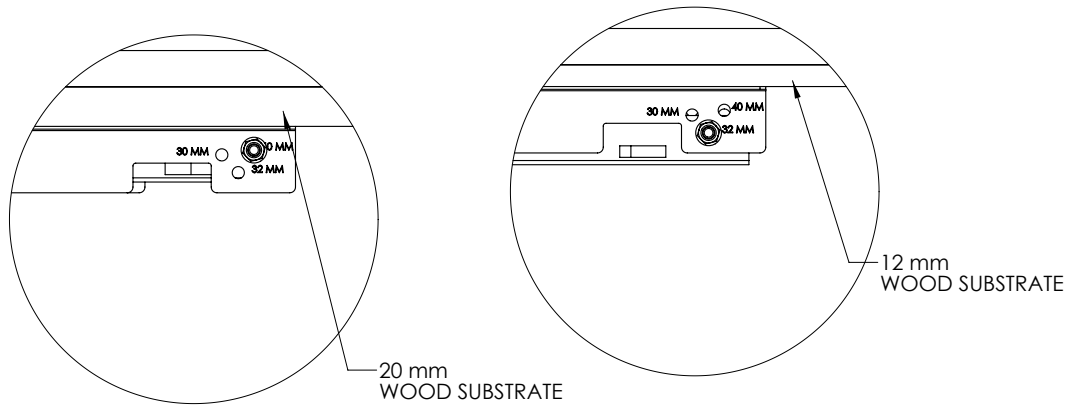

TO INSTALL UNDER COUNTER

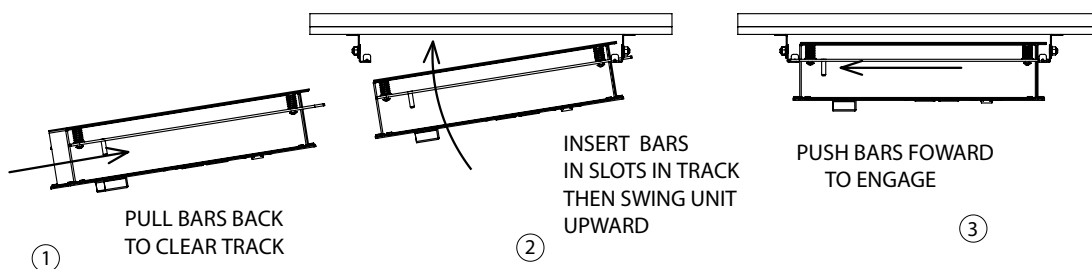

CookTek Incogneeto™ Unit Installation Instructions

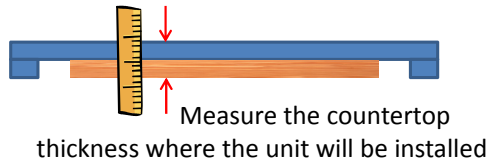

Top of unit must be 38 to 42mm (1.5 to 1.65") from top of counter

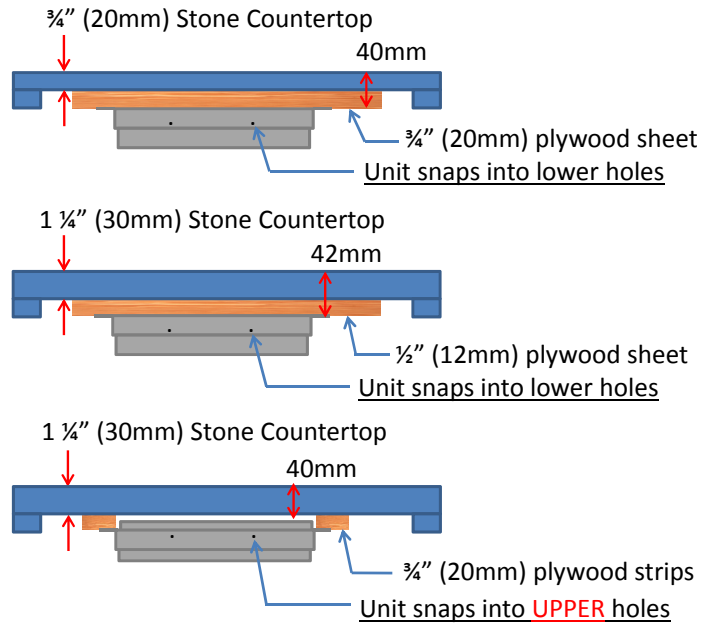

If countertop is not prepared as above, STOP, and correct countertop

Installation



- Always mount vertically, do not mount horizontally
- Use included screws, Don't use alternate hardware



- Do not over tighten
- Do not use lock-washers



Over Tightening Causes Failures

Lock Washer Damage

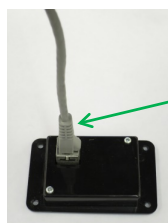

- Insert Ethernet cable straight into RJ-45 connector
- Strain relieve cable so that connector entry remains straight
- Route and protect cable to prevent damage/pulling from behind/under counter installations/storage

10. Technical specifications

Specifications	
Model Number	B652-U2
Power Requirements	200-240VAC, 1 Ph
Power Consumption	650W (max)
Voltage	200-240VAC, 50/60 Hz
Amperage	2.7A (max)
Power Range	100-650W
Preset Temperatures	150, 160, 175, 190°F / 65, 70, 80, 85°C
Additional Temperature Settings Range	80-190°F / 30-85°C
Dimensions (in)	17.50" x 17.50" x 4.50"
Dimensions (mm)	445 x 445 x 114
Weight	15 lbs / 6.8 kg
Packaged Weight	20 lbs / 9 kg
Packaged Dimensions (in)	20" x 20" x 10"
Packaged Dimensions (mm)	508 x 508 x 254
Power Cord Length	6 ft / 1.8 m
Plug Type	NEMA 6-20Pin US/Canada - country specific elsewhere
Remote Control Box Cord Length	6 ft / 1.8 m

