



USER MANUAL

for WRP100 Wireless Repeater

v1.01



Legal notice

Copyright © 2013 TELTONIKA Ltd. All rights reserved. Reproduction, transfer, distribution or storage of part or all of the contents in this document in any form without the prior written permission of TELTONIKA Ltd is prohibited. The manufacturer reserves the right to modify the product and manual for the purpose of technical improvement without prior notice.

Other product and company names mentioned herein may be trademarks or trade names of their respective owners.

Attention



Before using the device we strongly recommend reading this user manual first.



Do not rip open the device. Do not touch the device if the device block is broken.



All wireless devices for data transferring may be susceptible to interference, which could affect performance.



The device is not water-resistant. Keep it dry.

Table of Contents

Legal notice	2
Attention	2
SAFETY INFORMATION	4
Device connection	5
Introduction	6
Key Features	6
Specifications	6
Wi-Fi	6
Electrical, Mechanical & Environmental	6
Applications	7
Setting up the device	8
Connecting to RUT500	9
States of the device	9
User interface	10
Basic settings	10
Advanced settings	10
Status	10
Advanced settings	11
Connect	11
System log	12
Management	12
Update Firmware	13
Using the button	13
Configuring your computer	14
Glossary	18

SAFETY INFORMATION

In this document you will be introduced on how to use a WRP100 repeater safely. We suggest you to adhere to the following recommendations in order to avoid personal injuries and or property damage.

You have to be familiar with the safety requirements before using the device!

To avoid burning and voltage caused traumas, of the personnel working with the device, please follow these safety requirements.



Do not mount or service the device during a thunderstorm.



To avoid mechanical damages to the device it is recommended to transport it packed in a damage-proof pack.



Protection in primary circuits of associated PC and the device against short circuits and earth faults of associated PC shall be provided as part of the building installation.

To avoid mechanical damages to the device it is recommended to transport it packed in a damage-proof pack. While using the device, it should be placed so, that its indicating LEDs would be visible as they inform in which working mode the device is and if it has any working problems.

Protection against overcurrent, short circuiting and earth faults should be provided as a part of the building installation.

Signal level of the device depends on the environment in which it is working. In case the device starts working insufficiently, please refer to qualified personnel in order to repair this product. We recommend forwarding it to a repair center or the manufacturer. There are no exchangeable parts inside the device.

Device connection

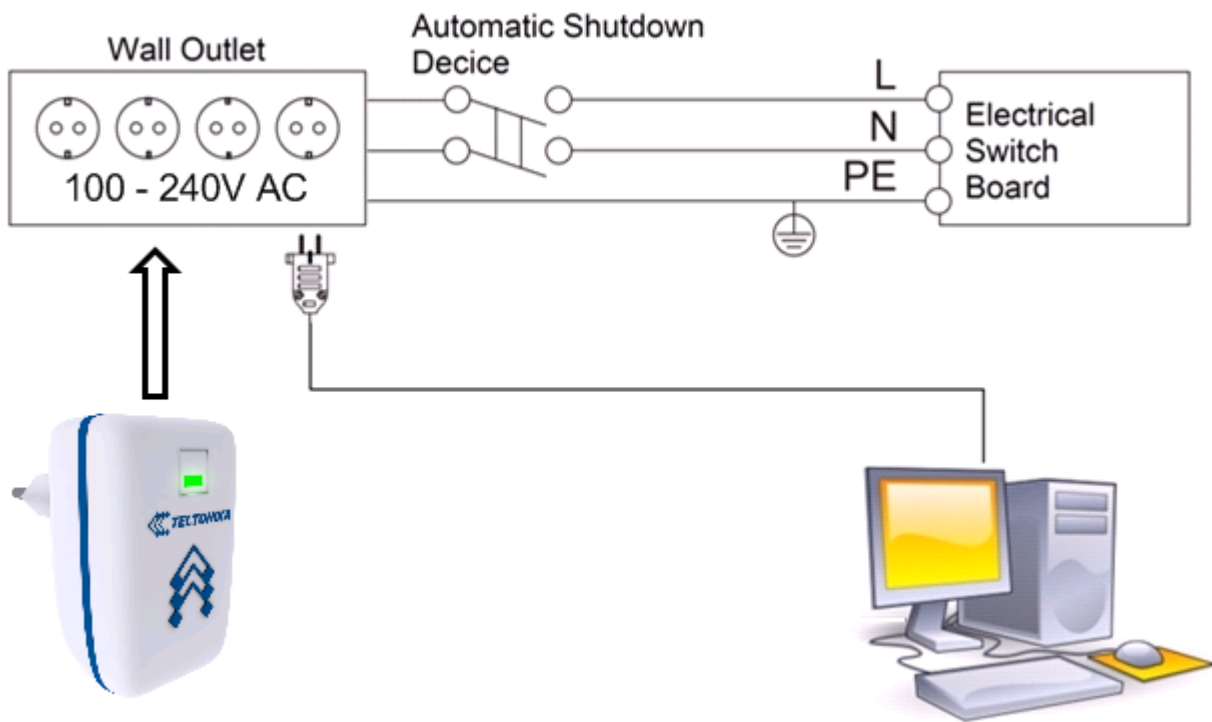

Introduction

Thank you for purchasing a WRP100 wireless repeater!

WRP100 wireless repeater is designed to extend the coverage of your existing Wi-Fi network. WRP100 is compliant with IEEE802.11b/g/n standards and can be used with most of the latest Wi-Fi access points while not forgetting the older ones. Existence of internal antenna and integrated power supply means that no external accessories are required and using the device is as simple as plugging it into AC power socket.

Key Features

- Complies with IEEE 802.11n, IEEE 802.11g, IEEE 802.11b wireless standards
- Internal antenna
- Internal power supply
- Bridged wireless interfaces
- Three LEDs for easy status indication
- One multifunctional button
- Automatic connection to Teltonika's RUT500 3G router
- Configuration using web browser

Specifications

Wi-Fi

- High performance 320 MHz CPU with 256 Mbits SDRAM
- IEEE 802.11b/g/n standards
- Operates within 2.414 – 2.484 GHz frequency range
- 64/128-bit WEP, WPA, WPA2, WPA&WPA2 encryption methods
- 1 x 2.5dBi wireless antenna

Electrical, Mechanical & Environmental

- Dimensions (H x W x D) 75mm x 58mm x 45mm
- Weight 64g
- Power supply 100 – 240 (50 – 60 Hz) VAC socket
- Power consumption < 3W
- Indicators 3 x status LEDs
- Operating temperature 0° to 50° C
- Storage temperature -20° to 70° C
- Operating humidity 10% to 90% non-condensing
- Storage humidity 5% to 95% non-condensing

Applications

WRP100 wireless repeater is most useful in the situation when your Wi-Fi device is outside the coverage area of the access point. In this case WRP100 should be place roughly in the middle between your Wi-Fi device and access point. Repeater will connect to the access point and provide Wi-Fi network for your device.

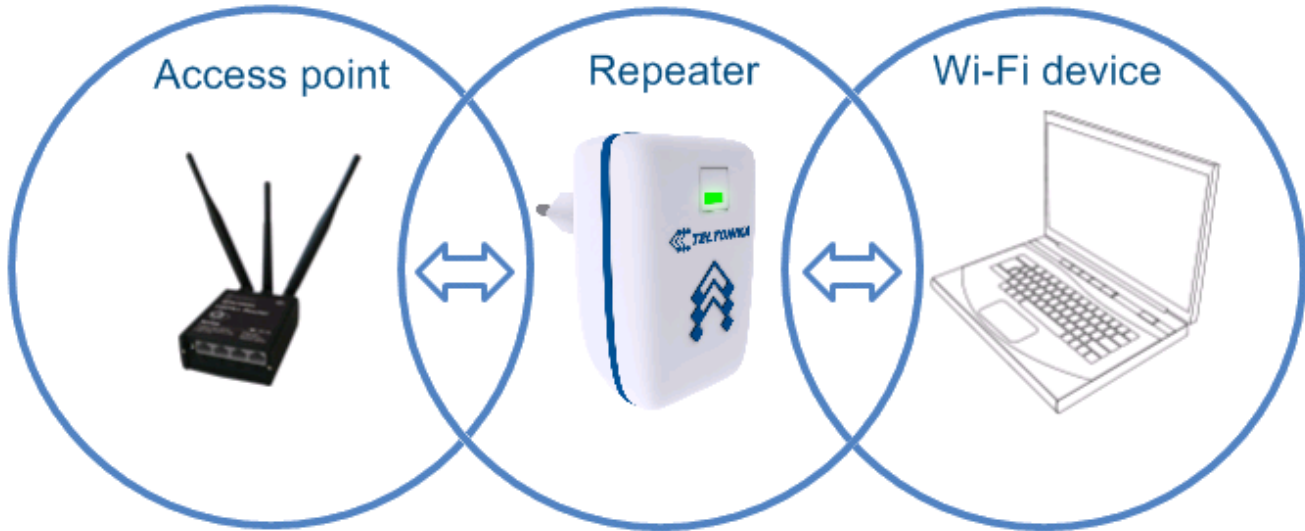

Setting up the device

Described below is quick sequence for setting up the device. Advanced configuration can be found further down in this manual.

1. Power up the device

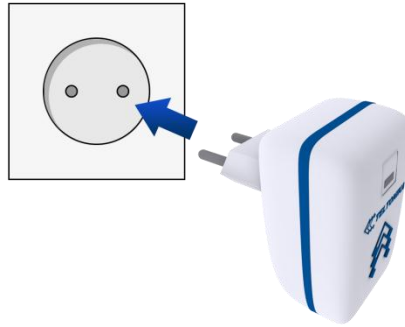

2. Wait for yellow LED to stop blinking



3. Connect to **WRP100_Teltonika** wireless network using your PC, netbook, tablet or smartphone.
4. Open page <http://10.11.12.13> in your browser

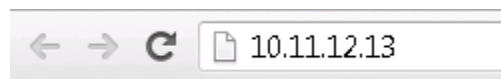

5. Select wireless network, enter password (if required) and press connect

Name	Security	Signal strength	Password	Action
TeltonikaWifi	WPA1PSKWPA2PSK/TK	96%	*****	connect
Teltonika	NONE	10%		connect

6. Wait for green LED to light up



7. If LED becomes yellow instead of green it means that connection to selected network has failed. Try again starting from **step 3** and verify that you are entering correct password.
8. If you want to change the network that is being repeater press and hold the button on the device for 5 seconds. After the LED becomes yellow again start configuration from **step 3**.

Connecting to RUT500

WRP100 is designed for simple connection to Teltonika's RUT500 series 3G routers. To connect WRP100 to RUT500 follow these steps:

1. Power up the device
2. Wait for yellow LED to stop blinking
3. Press the button on WRP100
4. Wait for green LED to light up

States of the device

These states of WRP100 wireless repeater can be judged from the status LEDs of the device

State	LED	Comment
Booting	YELLOW blinking	Device is powering up
Ready for configuration	YELLOW	Device is ready to be configured. Connect to Wi-Fi network WRP100_Teltonika for configuration
Connecting to AP	GREEN blinking	Device is connecting to configured AP
Connected	GREEN	Device is connected and is repeating Wi-Fi network of the selected AP
Not connected	RED	Device can't connect to the selected AP
Connecting to RUT500	GREEN and RED blinking	Device is making quick connection to RUT500
Restoring defaults	RED blinking	Device is restoring factory defaults

Note: the states of status LEDs during the first 15 seconds after supplying power to the device should be ignored.

User interface

WRP100 has built-in HTTP server for configuration purposes. After connecting to device's Wi-Fi network **WRP100_Teltonika** its user interface can be access with web browser by opening page <http://10.11.12.13>

Basic settings

Basic settings window allows to set up the device while requiring very few parameters for the user to input. Though the configuration possibilities of the **Basic settings** window are minimal they are enough in most cases.

TELTONIKA Basic Advanced				
Available Wireless Network Connections				
Refresh				
Name	Security	Signal strength	Password	Action
TeltonikaWifi	WPA1PSKWPA2PSK/TK	100%	<input type="text"/>	connect
TeltonikaM	NONE	39%	<input type="text"/>	connect
Teltonika	NONE	15%	<input type="text"/>	connect
TeltonikaT	NONE	100%	<input type="text"/>	connect

Field name	Possible values	Explanation
Name	-	Name (SSID) of the discovered Wi-Fi network.
Security	-	Type of security used by the specific Wi-Fi network.
Signal strength	-	Signal strength of the specific Wi-Fi network.
Password	“passwd”	Password of the Wi-Fi network. Has to be specified if the network is secured.

Refresh – Press to repeat the scan of available Wi-Fi networks

Connect – Press to configure the device to repeat the selected network (password must be supplied if required)

Advanced settings

Advanced settings window offers more configuration options that may be required in some situations.

Status

Windows displays information of the device such as firmware version, up time, MAC address, etc.

TELTONIKA Basic Advanced	
<ul style="list-style-type: none"> Status Advanced settings Connect System log Management Update firmware 	System Info Firmware version: WRP100_R_01.00.83 System Up Time: 22 mins, 54 secs
	Local Network Local IP Address: 10.11.12.13 Local Netmask: 255.255.255.0 MAC Address: 00:1E:42:80:1A

Advanced settings

Advanced settings of the wireless interface can be configured in this window.

Advanced Wireless	
Short Preamble	<input checked="" type="radio"/> Enable <input type="radio"/> Disable
Short Slot	<input checked="" type="radio"/> Enable <input type="radio"/> Disable
Tx Burst	<input checked="" type="radio"/> Enable <input type="radio"/> Disable
Carrier Detect	<input type="radio"/> Enable <input checked="" type="radio"/> Disable
Tx Beamforming	Disable ▾

Field name	Possible values	Explanation
TX Power	1 – 100	Set Tx power of the wireless interface.
Short Preamble	Enable/Disable	Enable or disable using of short preamble for CRC checks. This parameter should match the settings of access point
Short Slot	Enable/Disable	Enable or disable using of short slot value when retransmitting the packets after collision.
Tx Burst	Enable/Disable	Enable or disable using of Tx burst .
Carrier Detect	Enable/Disable	Enable or disable using of carrier detect .
Tx Beamforming	Both/Explicit TxBF/Implicit TxBf/Disable	Enable or disable using of Tx beamforming .

Apply – Press to apply new settings to the device

Cancel – Press to cancel current changes

Connect

Use this window to manually set up the parameters of the selected Wi-Fi network. Manual configuration is necessary if access point is not broadcasting its SSID name.

AP Client Parameters	
SSID	TeltonikaWifi
MAC Address (Optional)	00:60:b3:58:ff:05
Security Mode	WPA2PSK ▾
Encryption Type	TKIP ▾
Pass Phrase	password

Site Survey							
Ch	SSID	BSSID	Security	Signal(%)	W-Mode	ExtCh	NT
3	TeltonikaWifi	00:60:b3:58:ff:05	WPA1PSKWPA2PSK/TKIPAES	60	11b/g	NONE	In
4	TeltonikaM	00:1e:42:80:00:11	NONE	50	11b/g	NONE	In
11	TeltonikaT	00:1e:42:80:00:f2	NONE	100	11b/g	NONE	In

Field name	Possible values	Explanation
SSID	"your_AP"	Set SSID (name) of the access point.
MAC Address	00:11:22:33:44:55	You may specify MAC address of the access point.
Security Mode	OPEN/SHARED/WPA2PSK/WPA2PSK	Set security mode used by the selected access point.
Encryption type	WEP/None/TKIP/AES	Set encryption type used by the selected access point.
Pass Phrase	"password"	Set pass phrase used by the selected access point.

SCAN – Press to repeat the scan of available Wi-Fi networks

System log

This windows displays the log of the device

Refresh Clear

System Log:

```

Jan 1 00:00:21 WRP100_Teltonika user.warn kernel: SYNC - BBP R4 to 20MHz.1
Jan 1 00:00:21 WRP100_Teltonika user.warn kernel: SYNC - BBP R4 to 20MHz.1
Jan 1 00:00:21 WRP100_Teltonika user.warn kernel: SYNC - BBP R4 to 20MHz.1
Jan 1 00:00:21 WRP100_Teltonika user.warn kernel: SYNC - BBP R4 to 20MHz.1
Jan 1 00:00:21 WRP100_Teltonika user.warn kernel: SYNC - BBP R4 to 20MHz.1
Jan 1 00:00:21 WRP100_Teltonika user.warn kernel: SYNC - BBP R4 to 20MHz.1
Jan 1 00:00:21 WRP100_Teltonika user.warn kernel: RTMP_TimerListAdd: add timer
Jan 1 00:00:21 WRP100_Teltonika user.warn kernel: Main bssid = 00:1e:42:80:11:1
Jan 1 00:00:21 WRP100_Teltonika user.warn kernel: <==== rt28xx_init, Status=0
Jan 1 00:00:21 WRP100_Teltonika user.warn kernel: 0x1300 = 00064380
Jan 1 00:00:21 WRP100_Teltonika user.warn kernel: Raeth v3.0 (Tasklet,SkbRecycl

```

Refresh – Press to reload the log file

Clear – Press to clear the log

Management

Configuration can be uploaded, downloaded or reset in this window.

Export Settings

Exports Settings To File

Import Settings

Settings file location No file chosen

Export – Press to export (download) current configuration to your computer

Choose File – Press to select the configuration file to be imported (uploaded) to the device

Import – Press to import (upload) new configuration file

Load Factory Defaults

Load Factory Defaults And Reset

Load Defaults – Press to restore factory defaults and restart the device

Update Firmware

Firmware of the device can be updated in this window

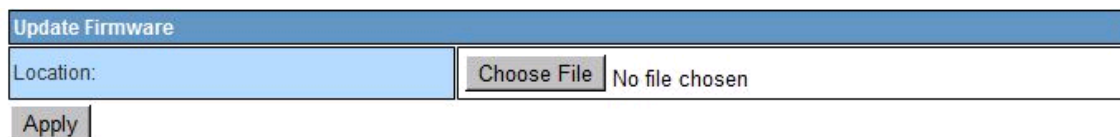

Update Firmware	
Location:	<input type="button" value="Choose File"/> No file chosen
<input type="button" value="Apply"/>	

Choose File – Press to select the firmware file to be written to the device

Apply – Press to start the firmware update process. Do not unplug the device before the process has finished

Using the button

WRP100 wireless repeater has one multifunctional button located near the status LEDs. The device can perform two different actions depending on the duration the press of the button:

Connect to RUT500 – Press the button to initialize quick connection to Teltonika's RUT500 series router.

Restore factory defaults – Press and hold the button for 5 seconds to restore factory defaults and reset the device

Configuring your computer

Generally there is no need to change anything on your computer to connect to WRP100. The only requirement is for wireless network connection to be enabled.

This example shows how to set up your computer under Windows 7 to connect to WRP100. On windows Vista: click **Start -> Control Panel -> Network and Sharing Centre -> Manage network Connections -> (Go to step 4)**. On Windows XP: Click **Start -> Settings -> Network Connections -> (see step 4)**. You won't see "Internet protocol version 4(TCP/IPv4)", instead you'll have to select "TCP/IP Settings" and click **options -> (Go to step 6)**.

We first must set up our network card so that it could properly communicate with the repeater.

1. Press the **Start** button

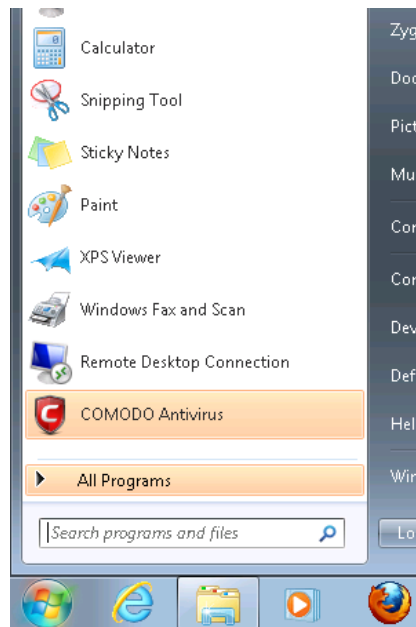

2. Type in "network connections", wait for the results to pop up.

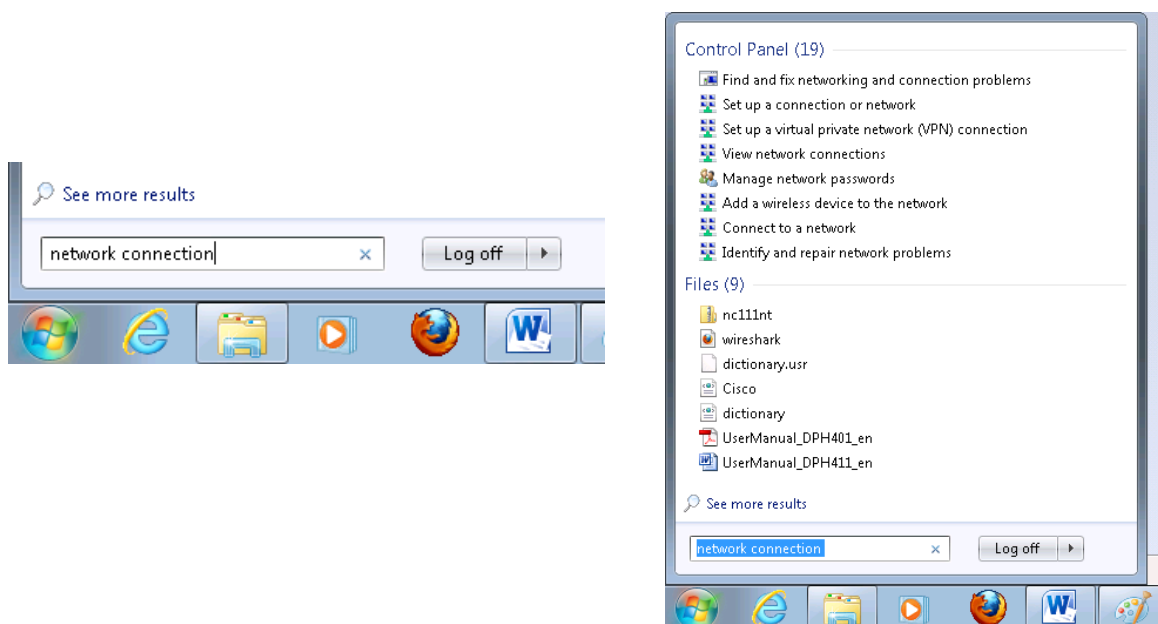

3. Click **“View network connections”**

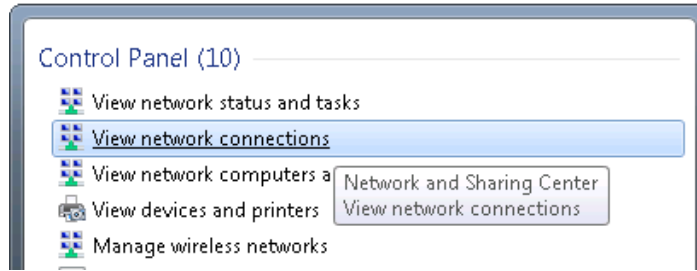

4. Then right click on your wireless device that you use to connect to other access points (It is the one with the name **“Wireless Network Connection”** and has signal bars on its icon).

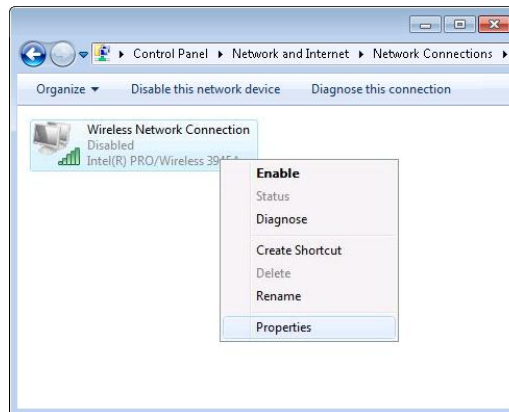

5. Select **Internet Protocol Version 4 (TCP/IPv4)** and then click Properties

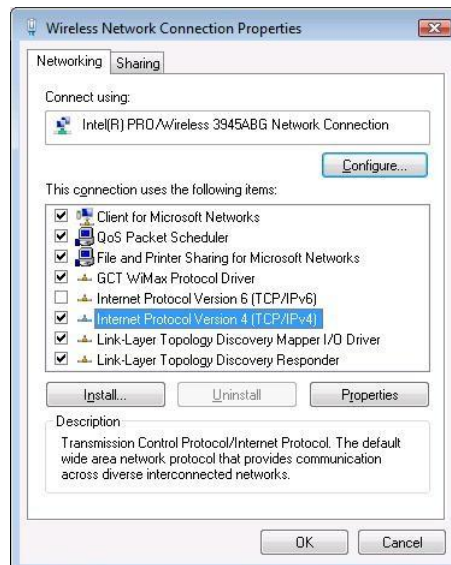

6. By default WRP100 is going to have DHCP enabled, which means that if you select “**Obtain an IP address automatically**” and “**Obtain DNS server address automatically**”, WRP100 should lease you an IP and you should be ready to login.

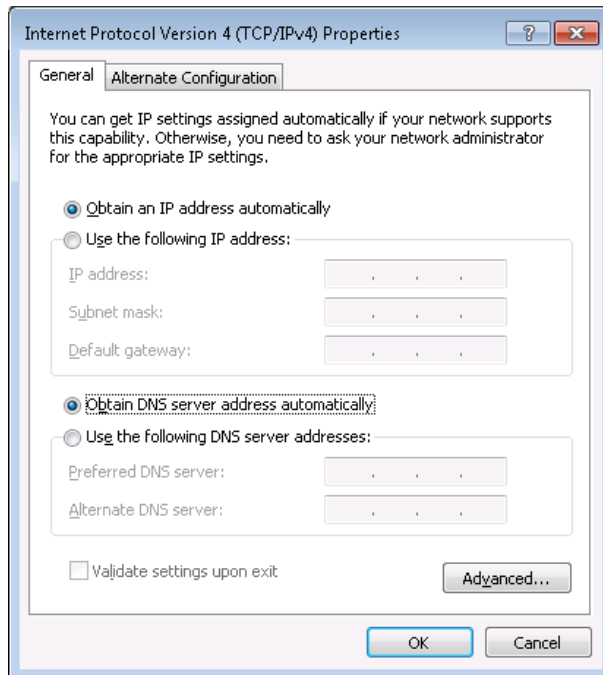

7. If you choose to configure manually here’s what you do:
First select an IP address. Due to the stock settings that your WRP100 has arrived in you can only enter an IP in the form of **10.11.12.XXX** , where XXX is a number in the range of 14-253 (10.11.12.14 , 10.11.12.15, 10.11.12.16 and so on). Next we enter the subnet mask: this has to be “**255.255.255.0**”. Default gateway and DNS server IPs are not required. Press **OK** to save the settings.

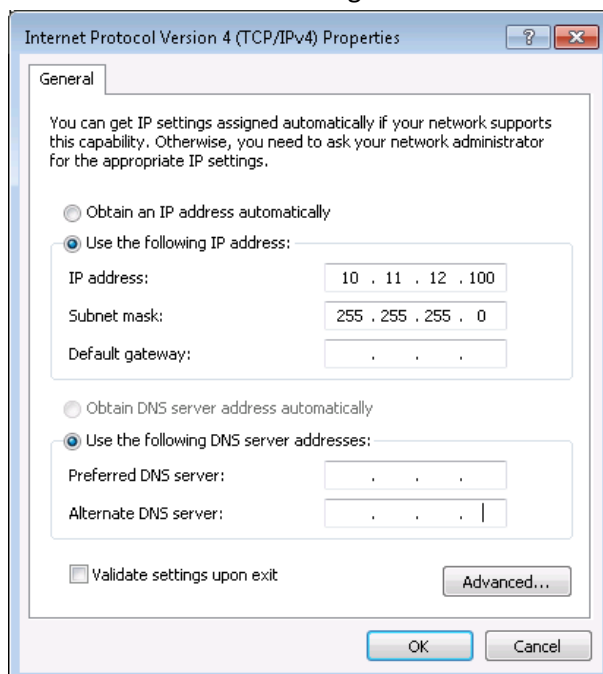

Note: Manual settings can be useful if you want to reach user interface of the router when it is already configured and connected to access point. Manual settings will override IP address provided by access point so internet connection will be lost.

8. Right click on the Wireless network icon and select **Connect / Disconnect**. A list should pop up with all available wireless networks. Select “**WRP100_Teltonika**” and click **connect**.
9. If WRP100 is powered and yellow LED is lit open page <http://10.11.12.13> in your browser to reach user interface of WRP100

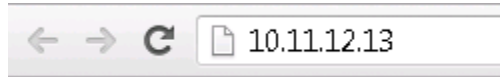

Glossary

DHCP – The Dynamic Host Configuration Protocol (DHCP) is a network configuration protocol for hosts on Internet Protocol (IP) networks. Computers that are connected to IP networks must be configured before they can communicate with other hosts. The most essential information needed is an IP address, and a default route and routing prefix. DHCP eliminates the manual task by a network administrator. It also provides a central database of devices that are connected to the network and eliminates duplicate resource assignments.

AP – Access point. An access point is any device that provides wireless connectivity for wireless clients. In this case, when you enable Wi-Fi on your router, your router becomes an access point.

DNS – Domain Name Resolver. A server that translates names such as www.google.it to their respective IPs. In order for your computer or router to communicate with some external server it needs to know it's IP, its name "www.something.com" just won't do. There are special servers set in place that perform this specific task of resolving names into IPs, called Domain Name servers. If you have no DNS specified you can still browse the web, provided that you know the IP of the website you are trying to reach.

LED – Light-Emitting Diode is a semiconductor light source. LEDs are used inside WRP100 for indicating device status.

SSID – Service Set Identifier. The SSID identifies a specific wireless LAN. Before associating with a particular wireless LAN, a client must have the same SSID configured as the access point