



EN

## WALL CERAMIC FAN HEATER

*Chic*



## OPERATING INSTRUCTIONS

Read the instructions carefully before installing and operating the appliance or performing maintenance operations. Observe all the safety instructions; failure to observe the instructions may cause accidents and/or damages. Store these instructions for future reference.

## GENERAL SAFETY INFORMATION

- Use this fan heater only as outlined in this manual. Any other use not recommended by the manufacturer may cause fire, electric shock or injury to people.
- Ensure that the mains power complies with the voltage specified on the fan heater 's data plate (220-240V~/50Hz).
- This product is not a toy. Children should be adequately supervised to ensure that they do not play with the appliance.
- **This heater has been projected in order to install it on the wall, you should keep 1,8 m from the floor and at least 25 cm from the two sides of the wall. Do not put it on the floor.**
- This appliance is not suitable for use by people (including children) with reduced physical, sensory or mental abilities, or without the necessary experience and knowledge, unless they have been adequately supervised and instructed concerning use of the appliance by a person responsible for their safety.
- Do not restrict the air inlet and outlet grilles.
- The appliance heats up slightly when in use. In order to avoid burns, do not let bare skin touch hot surfaces.
- Ensure that all objects are at least 1 meter from the front and sides of the appliance.
- Disconnect the mains power when the appliance is not used or for cleaning operations.
- Avoid using the fan heater in dusty environments or in the presence of inflammable vapours (e.g. in workshops or garages) or paint vapours.
- Do not place anything on the appliance, use the appliance to dry clothing.
- Use the appliance in a well-ventilated area.
- Avoid placing fingers or foreign objects in the air inlet/outlet grilles, as this may lead to electric shock or fire and may damage the appliance.
- To avoid the risk of fire, do not block the grilles or tamper with them in any way while the fan heater operates.
- **Do not use the appliance if the cord or plug are damaged.** If the power supply cord is damaged, it must be replaced by the service centre so as to avoid any safety risks.
- Do not operate the appliance if it has fallen from a height or has suffered damage in any way. Contact a service centre to examine the appliance or perform any electrical or mechanical repairs.
- The most common cause of overheating is the build-up of dust in the appliance. Remove dust deposits by unplugging the appliance and cleaning the air outlets and grilles with the aid of a vacuum cleaner.
- Do not use abrasive detergents for cleaning this appliance. Clean the appliance with the aid of a damp (not wet) cloth rinsed in hot soapy water. Always remove the plug from the mains socket before cleaning.
- To disconnect the fan heater, push the switch to OFF and remove the plug from the socket. Pull on the plug only. Avoid pulling on the cord when disconnecting the fan heater.
- Do not place any objects on the cord and do not bend it.
- It is not advisable to use extension cords, as these may overheat and cause the risk of fire. Do not use a single extension cord to operate multiple appliances.
- Do not immerse the cord, plug or any other element of the appliance in water or other liquids.
- Do not touch the plug with wet hands.
- Do not place the fan heater above or near another heat source.

### **WARNING: AVOID COVERING THE FAN HEATER TO PREVENT IT FROM OVERHEATING.**

The symbol below signals the above warning:



- The fan heater may cause the risk of fire if, while in operation, is covered by or comes into contact with **inflammable** material including curtains, drapery, blankets, etc. **KEEP THE FAN HEATER AWAY FROM THESE MATERIALS.**
- Do not connect the appliance to the mains power before it has been properly assembled and positioned.
- Do not run the cord under carpets. Do not cover the cord with blankets, carpets or similar materials. Place the cord far away from busy areas or where it cannot be accidentally pulled-out.
- Do not operate the fan heater in close proximity to bathtubs, showers, washbasins or pools.
- Do not position the fan heater below a socket outlet.
- Do not operate the appliance outdoors.
- **WARNING: do not use the fan heater with a controller or any other external device that activates the appliance automatically, as there may be a risk of fire if the fan heater is covered or incorrectly positioned.**
- Upon initial start-up, the fan heater may emit a slight, harmless smell. This smell is a normal effect of the initial heating up of the internal heating elements, and should not recur later on.
- **WARNING: DO NOT DEPEND ON THE ON/OFF BUTTON SWITCH AS THE SOLE MEANS OF DISCONNECTING POWER. WHEN SERVICING OR MOVING THE FAN HEATER, ALWAYS UNPLUG THE POWER CORD.**
- A fan heater has hot and arcing or sparkling parts inside. It must not be used in potentially dangerous locations such as flammable, explosive, chemical-laden or wet atmosphere.
- Always unplug the fan heater when not in use.
- In order to avoid accidents turn unit off if unattended.
- In the event of any problems (abnormal noise or a strange smell) switch off the appliance immediately, do not attempt to repair it and take it to your local after sales service.

## DESCRIPTION OF PARTS

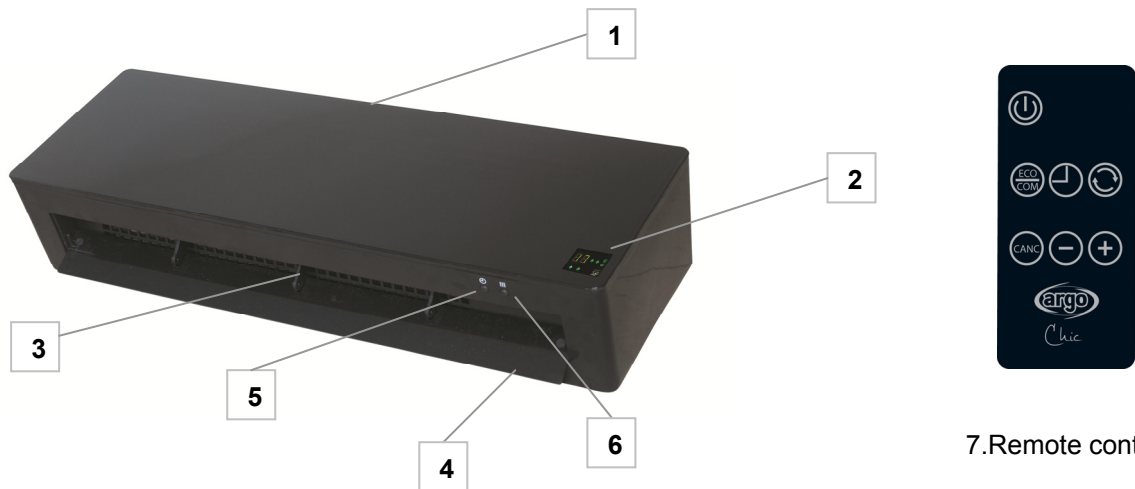

1. Air inlet grille
2. LED display
3. Air outlet grille
4. Horizontal flap
5. **TIMER** button (**TIMER OFF**)
6. **ON/OFF** and selection button

7. Remote control

## INSTALLATION INSTRUCTIONS

The fan heater must be installed on a wall before operating. Don't try to use it without installation.  
The installation sequence of the fan heater is as follows:

1. Find a space to install the fan heater (See Figure 1).
2. Drill two holes of the dimension of the expansible tubes  $\varnothing$  - 8 mm - in the wall (See Figure 2) – D= 575 mm

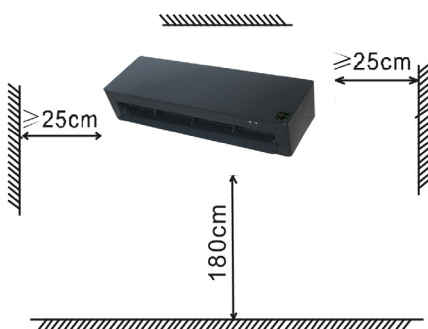

Figure 1

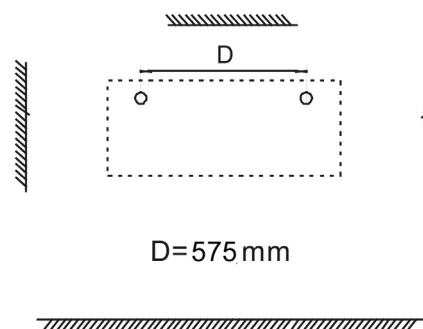

Figure 2

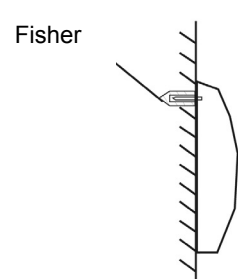
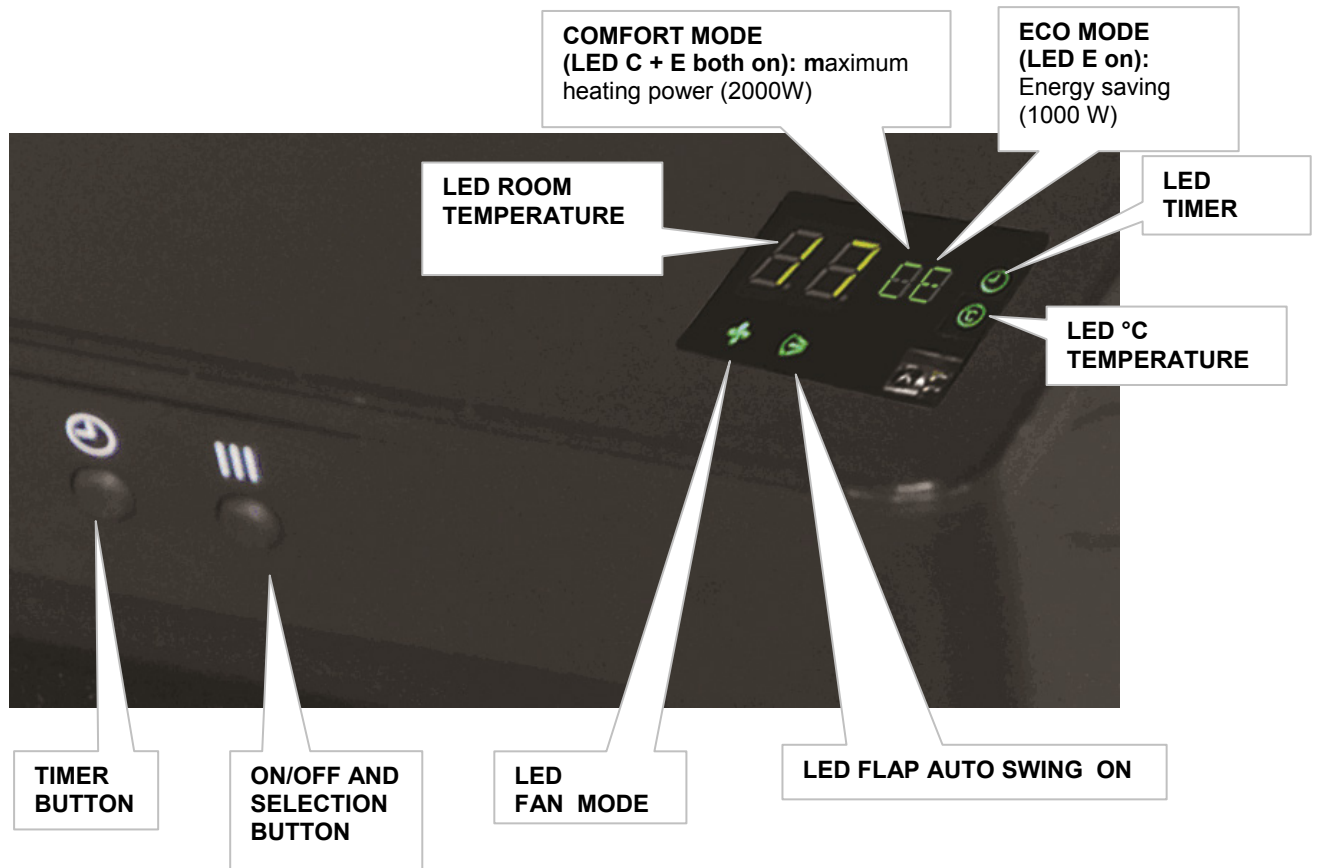

Figure 3

3. Insert the expansible tubes into the holes and tighten them with the screws provided firmly.  
**NOTE: Fasten the screws tightly. Do not fasten the screw into the expansible tube thoroughly; the length of the bare parts should be 10 mm.**
4. Mount the fan heater to the wall (See Figure 3).  
Make sure the two holes located on the back of the heater do aim at the above two screws, then push the heater backwards to the wall, and then downwards till the unit is stable.

## CONTROL PANEL AND LED DISPLAY ON THE UNIT



## REMOTE CONTROL

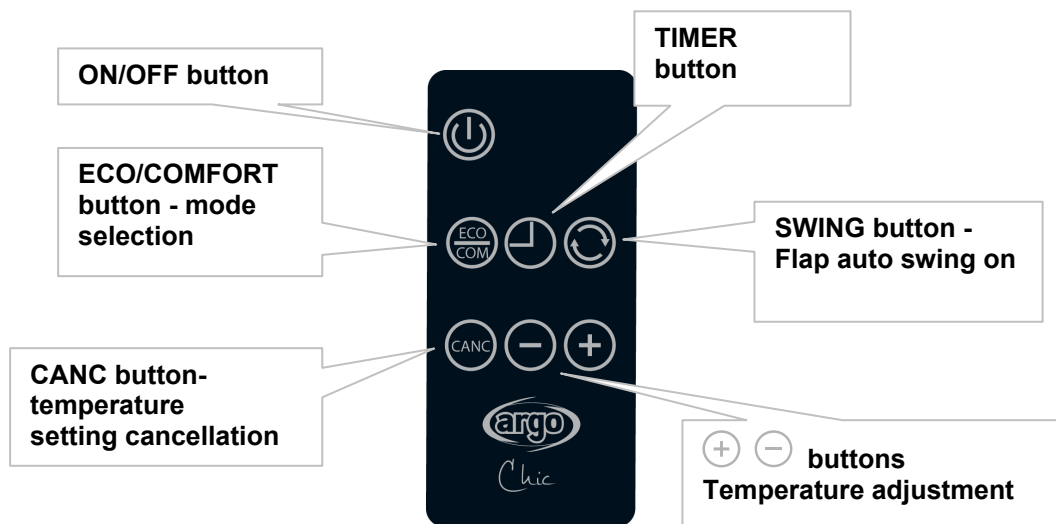

The remote control uses Lithium/Manganese button cells, model no. CR2025 -3V, compliant with Battery Directive no. 2006/66/CE (not supplied with the remote control).

## HOW TO INSERT / REMOVE THE REMOTE CONTROL BATTERIES (refer to the diagram below)

Open the battery cover at the rear of the remote control (press and pull the cover).

Place the battery into the cover, observing the correct polarity. Insert the cover onto the remote control.

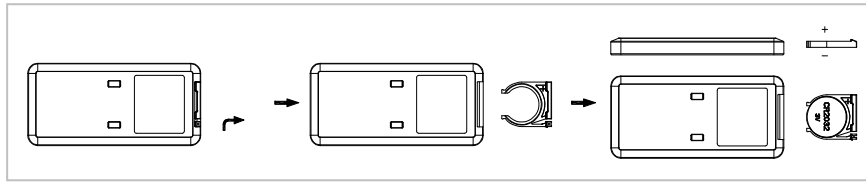



### Information for correct disposal of the battery in accordance with the European Directive 2006/66/EC

Please replace battery when its electricity charge is used up: please do not eliminate this battery together with normal household waste. It must be taken to special local community waste collection centres or to a dealer providing this service. Disposing of a battery separately avoids possible negative effects on the environment and human health deriving from an inappropriate disposal and enables its components to be recovered and recycled to obtain significant savings in energy and resources. In order to underline the duty to dispose of this equipment separately, the battery is marked with a crossed-out dustbin.

## HOW TO USE THE FAN HEATER

Connect the power cord to a suitable electric socket (220-240V~/50Hz).

### FAN MODE (FAN)

Press the button **ON/OFF** on the control panel (III) or on the remote control . The horizontal flap opens, the LED  on the display lights and the unit begins to operate in fan mode (the ceramic resistance is not active – no heating). The display shows the room temperature and the LED (°C) lights.

### HEATING MODE



- **ECO mode selection – Energy saving (1000W):**

Press a second time the button III on the control panel or the button  on the remote control. The LED "E" on the control panel lights.

- **COMFORT mode selection (2000 W):**

press a third time the button III on the control panel or the button  on the remote control. Both the LEDs "C E" on the control panel light.

- **SWING mode selection (SWING):**

press a fourth time the button III on the control panel or the button  on the remote control. The LED  lights.

### TIMER OFF



- **TIMER OFF SETTING:**

press the button  on the control panel or the remote control.

The LED  lights. Press this button once or more times to set the operation time (1-8 h).

### TEMPERATURE SETTING:

- **Temperature adjustment (ONLY WITH THE REMOTE CONTROL):**

press the buttons  and  in order to adjust the temperature (from 10 to 49°C).

If the selected temperature is higher than the room temperature, the unit automatically turns on and heats until the selected temperature is reached. The unit will automatically maintain the temperature at a constant level.

Press the button  to cancel the temperature setting.

NB.

**To completely shut the fan heater off, press the button III on the control panel or the button  on the remote control.**

**After switching off the fan heater, the fan will continue to run for a few seconds to cool the heating elements**

## OVERHEATING SAFETY DEVICE

In case of overheating the safety cut out protecting the heating element will automatically switch off the appliance. In this case the appliance stops working.

If this happens:

- switch off the heater;
- remove the causes of abnormal operation or overheating (i.e. obstacles in front of air inlet or air outlet grille, abnormal accumulations of dusts inside the appliance);
- let the heater cool down for 15/20 minutes;
- switch on again the heater and verify the correct operation.

If the fault persists, contact an Authorized Service Center.

## MAINTENANCE AND STORAGE

**ALWAYS UNPLUG THE APPLIANCE BEFORE CLEANING OR MAINTENANCE.  
IMPORTANT: DO NOT SUBMERGE THE CERAMIC FAN HEATER IN WATER**

### Cleaning the outside surface of the appliance

Turn the switch off and unplug before carrying out any maintenance work or moving the appliance.

Use a soft cloth to remove any dust from the fan heater.

If the fan heater is excessively dirty, use a soft cloth moistened with water and a mild detergent at a temperature lower than 50°C. Let the fan heater dry completely before use.

Do not use corrosive detergents or solvents such as petrol. Do not wash the appliance with water. Do not use oils, chemical substances or other items to clean that may damage the surface.

Use a vacuum cleaner to remove dust from the air inlet/outlet grilles.

### STORAGE

If the appliance is not used for prolonged periods, it must be stored together with this manual in its original packaging, in a cool and dry place.

### INFORMATION FOR CORRECT DISPOSAL OF THE PRODUCT IN ACCORDANCE WITH THE EUROPEAN DIRECTIVE 2012/19/EC



At the end of its working life this equipment must not be disposed of as an household waste. It must be taken to special local community waste collection centres or to a dealer providing this service. Disposing of electrical and electronic equipment separately avoids possible negative effects on the environment and human health deriving from an inappropriate disposal and enables its components to be recovered and recycled to obtain significant savings in energy and resources. In order to underline the duty to dispose of this equipment separately, the product is marked with a crossed-out dustbin.



[www.argoclima.com](http://www.argoclima.com)