

**USER MANUAL FOR  
 EXPLOSION PROOF EMERGENCY LIGHT  
 FITTING type FLXE 118 LED**

No: TEPEX.RS.053

Rev : 0

Date: 02.2015.

**1. GENERAL SAFETY INSTRUCTIONS**



**WARNING**

The user manual contains basic information about the product. Mounting, installation, usage and maintenance should be carried out under this user manual to provide and ensure safe operation within the nominal characteristics. This user manual complement national Regulation and Standards. The responsible person shall ensure their implementation. Failure off implement this user manual can reduce explosion protection and endanger people, property and the environment. Any improper and illegal actions as well as non-compliance with the provisions of this user manual excludes all responsibility by manufacturer side.

**Before installation/commissioning:**

- Carefully read all instructions,
- Execute proper training of responsible personnel,
- Check that the contents of these instructions is fully understandable by the responsible personnel,
- Make sure that all the requirements and national Regulations as well as all special security measures are applied.

**In lack of understanding:**

- Contact the manufacturer.

**During operation:**

- Ensure that this user manual and other work instructions are available to the responsible staff at all times,
- Check the implementation of these instructions and all other safety user's instructions.

**2. PURPOSE**

Explosion protected emergency luminaire type FLXE 118 LED ../. with autonomous power supply is intended for emergency and general lighting in areas with a potentially explosive atmosphere of gases, vapors and dust as well as their combinations in hazardous areas 1, 2, 21, 22, according to EN 60079-10- 1 / -2:2009. Explosion protected emergency luminaire allows planning and execution of emergency lighting and electrical requirements in accordance with EN 1838: 2008 and EN 50172: 2008 standard.

**3. CONFORMITY WITH STANDARDS**

The product complies with the EN 60598-1: 2008 / A11: 2009, EN 60598-2-22: 1998, EN 62034: 2012, EN 62031: 2008 and EN 62471: 2008 and all related regulations.

The product complies with the ATEX Directive 94/9 EC and standards:

- EN 60079-0: 2012,
- EN 60079-1: 2007,
- EN 60079-7: 2007,
- EN 60079-31: 2009.

The product is developed, manufactured and tested according to the prior art in accordance with EN 9001: 2008 and EN ISO / IEC 80079-34: 2011.

- The product is in compliance with the LV Directive 2006/95 EC.
- The product is in compliance with the RoHS Directive 2011/65 EU.
- The product is in compliance with the EMC Directive 2004/108 EC.

**4. DEGREE OF PROTECTION AND TECHNICAL DATA**

Certificate:	EXA 13 ATEX . . . .
Category and explosion protection:	 2G Ex d IIC T6 Gb or II 2G Ex d e IIC T6 Gb 2D Ex tb IIIC T80°C Db
Operating temperature range:	-20 °C : +50 °C
Degree of protection:	IP66 / IP67
Impact resistance:	IK 08

**USER MANUAL FOR  
 EXPLOSION PROOF EMERGENCY LIGHT  
 FITTING type FLXE 118 LED**

No: TEPEX.RS.053

Rev : 0

Date: 02.2015.

Class of protection:	I (protective earthing)
Rated operational voltage:	24 - 240 V AC/DC $\pm$ 10 % (see table of version)
Rated current:	10 VA
Power factor:	$\cos \varphi > 0,95$
Rated autonomy:	3 hours
Rated power and type of luminaire:	LED 2 x 1,2 W chip-on-board technology
Measuring luminous flux(power and battery operation):	200 lm
Correlated colour temperature:	6500 K
Color rendering index (CRI):	$>70$
Average rated life of LED:	$\geq 50\ 000$ hours
Visibility (EN 1838)	22 m
Operation efficiency:	$\sim 80\ %$
Change-over Battery operation: Mains supply operation:	U < 0,8 Un for more than 0,5 seconds U > 0,9 Un for more than 1 second
Battery:	Ni-Mh Saft VHT 3,6 V/2 Ah, IEC 61951-2:2011, built-in lighting, microprocessor controlled charging, discharging and battery monitoring
Battery life:	min. 2000 charging cycles or min. 4 years in nominal operating conditions
Charging time:	15 hours (12 hours > 90% nominal autonomy), continuous battery recharge
Connection terminals:	FLXE 118 LED .0/., FLXE 118 LED .1/. - snap-in terminals for mains supply L, L', N, PE, TEST, RESET, 2,5 mm <sup>2</sup> max. per terminal, solid, stranded, flexible - sol(r), s(r), f
	FLXE 118 LED .2/. - screw terminals, of Ex de Adapter ADP, for mains supply L, L', N, PE as well as TEST and RESET connectors; - 2,5mm <sup>2</sup> max. per terminal, solid, stranded, flexible - sol(r), s(r), f; nominal fastening torque 1,2Nm; - Ex e cable gland ISO 25 on Adapter ADP for cable $\phi$ 6-15mm; nominal fastening torque 2,5 Nm
	- earthing terminal (external) (equipotential), 2 x 6mm <sup>2</sup> max. per terminal, solid, stranded, flexible - sol(r), s(r), f; nominal fastening torque 2,2 Nm
Storage:	- max. 4 months on temperature +5 °C : +25 °C and humidity 65 $\pm$ 5%, - max. 1 month on temperature -20 °C : +5 °C or +25 °C : +70 °C and humidity 65 $\pm$ 5 %

**5. ISOCANDELA DIAGRAM [l/cd]**

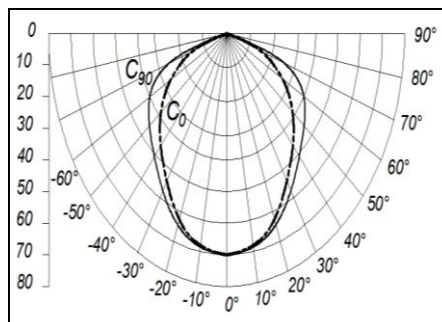

**6. MODEL CODE:**

FLXE 118 LED

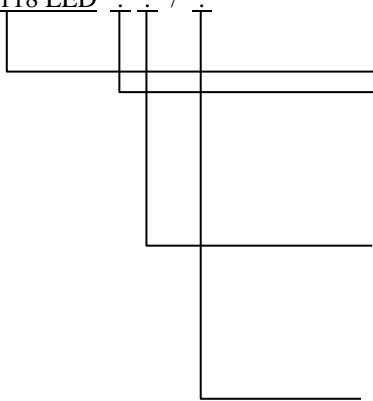

**Basic model type**

**Rated voltage:**

- 0 - 24 V AC
- 1 - 24 V DC
- 2 - 110 - 127 V AC
- 3 - 220 - 240 V AC

**Cable entry:**

- 0 - Ex d cable entry 2 x M20, ISO 965-1, ISO 965-3
- 1 - Ex d cable entry 2 x 3/4"NPT, ANSI/ASME B1.20.1
- 2 - Ex d cable entry 2 x M20, ISO 965-1, ISO 965-3 with one mounted Ex d e adapter type ADP 24/1 and one Ex d plug

**Emergency description (pictogram):**

In accordance with DIN 4844-2

0	Without markings	5	
1		6	
2		7	
3		8	
4			

**7. OPERATING MODES**

The lamp can operate with two types of connection:

**a) Maintained** (Dauerschaltung)

The light fitting can be used for general and orientation lighting with mains power supply via L' (installation switch). In case of voltage drop or an interruption in the mains power supply L, the light fitting will continue to operate in battery-powered mode, regardless of the status of installation switch L' (ON/OFF)..

**b) Non maintained** (Bereitschaftschaltung)

In case of voltage drop or an interruption in the mains power supply L, the light fitting will operate only in battery-powered mode.

In both types of the connection in the presence of continuous phase L, it is possible to verify the correctness of the emergency system by turning on the switch in the TEST circuit.

In both types of the connection in the presence or interruption of continuous phase L, regardless of the status of the power supply L', it is possible to turn OFF the emergency lighting, by turning ON the switch in the RESET circuit.

In case of an interruption in the mains power supply and then recovery of continuous phase L (L'), if the installation switch is turned ON, the light fitting will work in operating mode powered by the main power supply.

**Max. 20 light fitting in line wiring can be connected per external switch. For larger numbers of line wiring of TEST/RESET circuits and longer cable lengths, please consult the manufacturer.**

The light fitting is equipped with an electronic set for emergency lighting self-monitoring function and status signaling function. Self-monitoring is permanent. Status signalization is indicated with red and green indicator LED when the light fitting does not work.

**USER MANUAL FOR  
 EXPLOSION PROOF EMERGENCY LIGHT  
 FITTING type FLXE 118 LED**

No: TEPEX.RS.053

Rev : 0

Date: 02.2015.

**Constant green LED**, indicates the optimal functionality of the emergency system and the nominal autonomy, with batteries rated capacity within the rated ambient temperature. Batteries are permanently charged in "trickle charge" mode.

**Blinking green LED**, indicates the functionality of the emergency system in non-nominal autonomy. Autonomy is between 1 and 3 hours. Batteries are under charging phase with rated current.

**Constant Red LED**, indicates the dysfunction of the emergency system. Reasons for this may include some of the following:

- batteries are empty. The lamp should be left on the main power supply. After a while the signalization will by itself transfer into green LED, blinking lights and emergency lighting will become functional
- Ex d cover isn't screwed completely. Screw until green LED appears, blinking lights and emergency lighting becomes functional,
- connection is made incorrectly. Connection should be made according to the connection scheme
- batteries are old, permanently charged with rated current and are overheating. It is necessary to replace the LED module, type FLXE 10-130,
- batteries are old and can't reach the required charging voltage and capacity. It is necessary to replace the LED module, type FLXE 10-130,
- the fuse in the battery circuit  $\varnothing 5 \times 20 \text{ mm } 1.25 \text{ AT}$  is faulty. Should be replaced.  
 Faulty fuse indicates the defective batteries. You will probably need to replace the LED module, type FLXE 10-130,
- ambient temperature is outside specification limits.

**Self-monitoring does not include a control of the LEDs validity.**

**X 1 ABCD 180**

Description of tag on the light fitting **X 1 ABCD 180** , according to EN 60598-2-22:

X - emergency light fitting with built-in batteries

1 - emergency light fitting in a permanent connection

A - emergency light fitting with self-monitoring and status signaling function

B - emergency light fitting with main power supply option and automatically turn ON after power return option

C - emergency light fitting with RESET function

D - emergency light fitting for use in areas with special hazards

180 - emergency light fitting with autonomy of 3 hours

## 8. DIMENSION

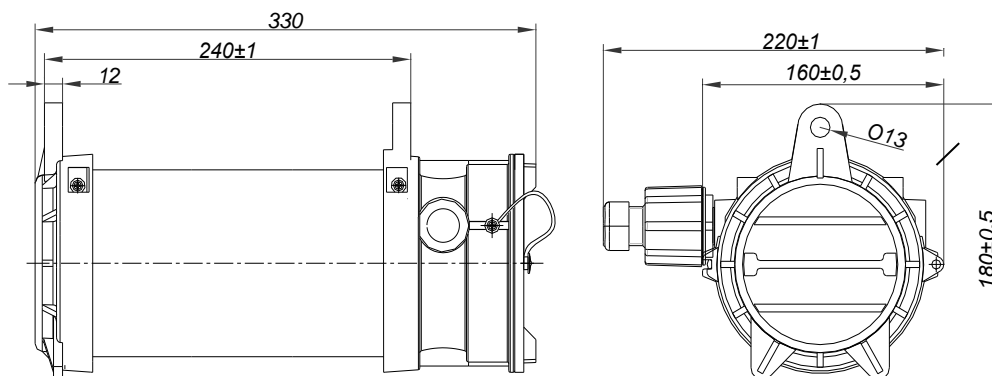

## 9. MOUNTING

Standard mounting is performed with suspension or fixing with a screws through an  $\varnothing 13 \text{ mm}$  hole in the housing. Using accessories for quick installation FLXE 20-170 can be directly fixed on the wall or ceiling - screw accessories  $\varnothing 8$  at a distance of 230 mm. Using accessories for quick installation FLXE 20-180 can be directly fixed on the pole with diameter up to 2".

Ex d glands and plugs are not part of the delivery for the types FLXE 118 LED .0 / . and FLXE 118 LED .1 / . but it must be provided by users. Standard design lamps assumes enclosure with blind cable entry's for volume protection. For lamp model with TEST and RESET function lamp shall be equipped with two glands Ex d or Ex de with two adapters.

When installing the user should comply with the instructions of the manufacturer. Performance FLXE 118 LED .2 / . the factory is equipped with an Ex de adapter and one blind plug. If the user requests through-wiring, it is necessary to use two Ex de adapter or two Ex d glands, but in this case TEST and RESET function can not be used. The lamp comes with a lid twisted entirely in the housing and mechanically locked screw M5x10 ISO 4027 which does not allowed self-loosening.

After each opening, lamp thread should be protected by protective agent threads.

**10. INSTALLING AND PUTTING INTO OPERATION**

Network connection is performed through screwless terminals located on the LED module FLXE 10-130 according to wiring diagram and technical data:

Maintained:

Permanent main line has to be connected to the L(1) terminal. Phase conductor for power supply has to be connected through installation switch to the L'(4) terminal. User should be careful that phase L and L' are the same phase. Neutral conductor has to be connected to the N(3) terminal and protective earth conductor to the PE(2) terminal.

Non maintained:

Permanent main line has to be connected to the L(1) terminal. Neutral conductor has to be connected to the N(3) terminal and protective earth conductor to the PE(2) terminal. L'(4) terminal is not connected.

External grounding, equipotential - IP is connected to an external terminal provided with a grounding conductor 6 mm2 solid (r), s (r), f.

Label with a wiring diagram is on the LED module FLXE 10-130.

If the electrical connection is performed through Ex de adapter, internal wiring is done by the manufacturer.

The electrical connection to the terminals of adapter have to be performed according to wiring diagram below.

“RESET” circuit is connected to the (5) and (6) terminals and “TEST” circuit to the (7) and (8) terminals.

In the case of parallel connection more than one RESET or TEST circuit one should be careful that the terminals of the same polarity are always short-circuited.

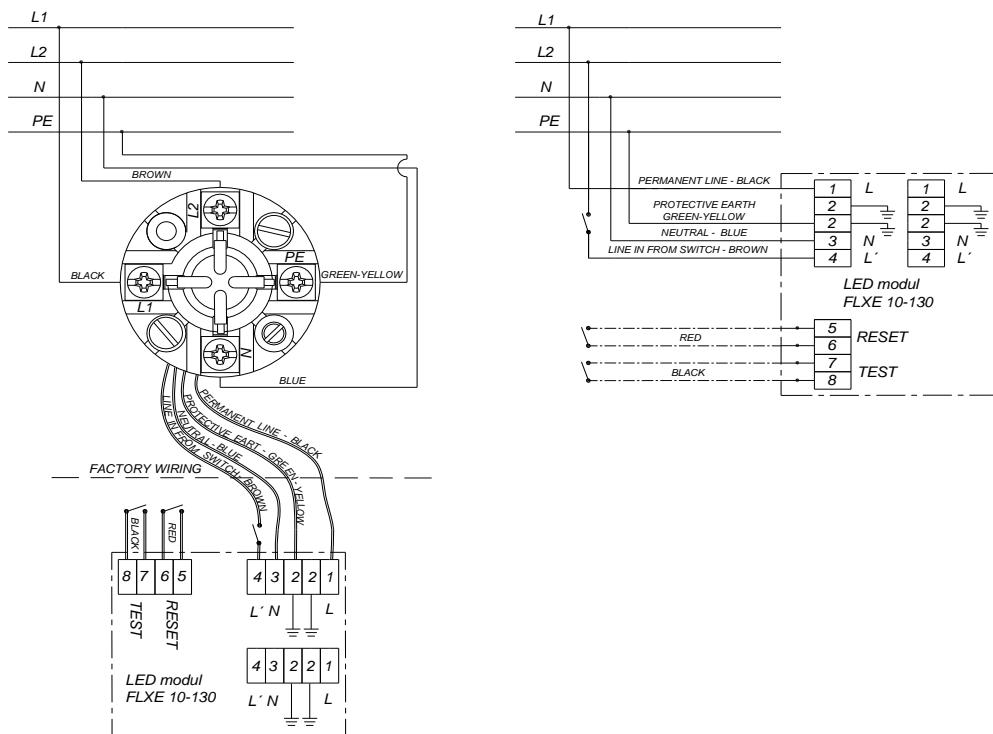

When commissioning the control insulation measurements should be performed with the test voltage max. 1000 V DC and the test current 1 mA and between:

- Neutral and earth conductor
- Phase conductor L and earth conductor
- Phase conductor L' and earth conductor

Testing between phase and neutral conductor is not allowed and will be provided with the wrong values because the electrical control gear is connected to the input circuit. For successfully testing it is necessary to disconnect the electrical control gear. This can be achieved by switching off the insulating coupling which is achieved by raising the assembly of the window frame.

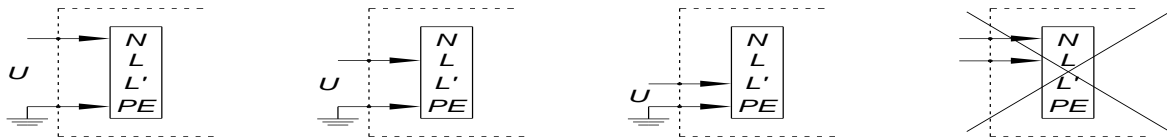

## 11. SPARE PARTS AND ACCESSORIES

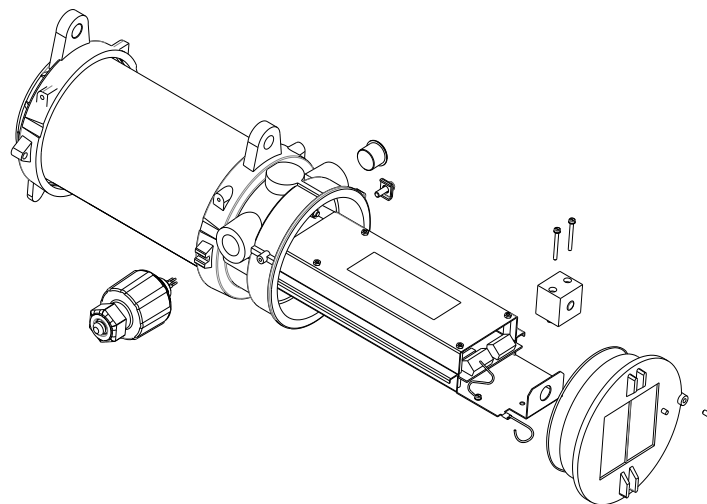

SKICA	DESCRIPTION	CODE	SKETCH	DESCRIPTION	CODE
	Housing cover set	FLXE 10-110		Ex d cable gland ISO 20	SPUD 20
	Cover gasket FLXE	FLXE 10-120		Ex d cable gland 3/4"NPT	SPUD 3/4"NPT
	Base plate FLXE	FLXE 10-130		Ex d plug ISO 20	SPCD 20
	Protective grid FLXE set	FLXE 20-140		Ex d plug 3/4"NPT	SPCD 3/4"NPT
	External reflector FLXE	FLXE 20-150		FLXE wall/ceiling mounting set	FLXE 20-170
	Junction box ADP 23	ADP 10-160		FLXE pipe mounting set	FLXE 20-180

## 12. RESPONSIBILITY AND AUTHORIZATION

This Manual represents the most relevant information about the product. Adequate national laws and regulations supplement it. Production, usage, certification and supervision are determined at the national level with:

- Regulations of Equipment and protective systems intended for use in potentially explosive atmospheres (NN br. 34/10.) and
- Regulations of minimum requirements for safety and health protection of workers and technical Inspection of facilities, equipment, installations and devices in potentially explosive atmospheres (NN br. 39/06, 106/07.), and EU Directive 1999/92/EC (ATEX 137).

The responsible person shall ensure their implementation at the facility.

## 13. STORAGE AND TRANSPORT

Transport and storage is only allowed in the original packaging, on the way pointed out on the carton box.

## 14. MARKING

Explosion protected fluorescent lighting fitting, type FLXE 118/. . is labeled with:

- a warning labels with technical data on the housing:

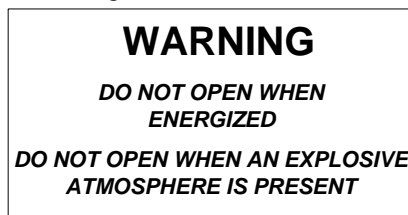

- a label with a wiring diagram on the LED module FLXE 10-130:

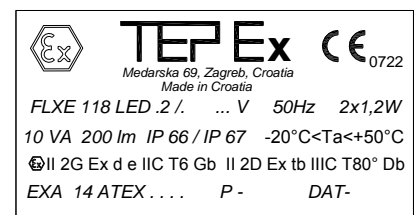
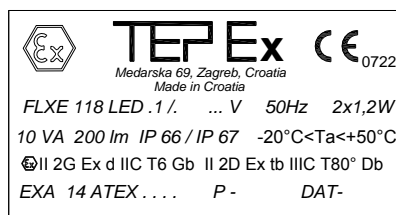
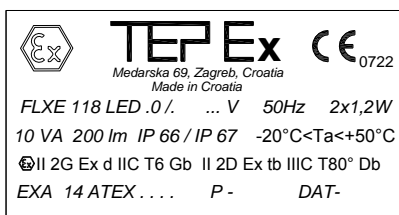

- a label with the wiring diagram in the LED module FLXE 10-130:

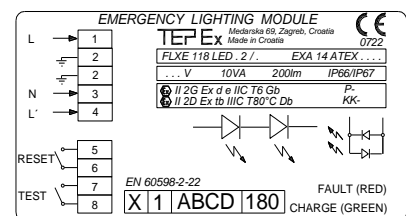
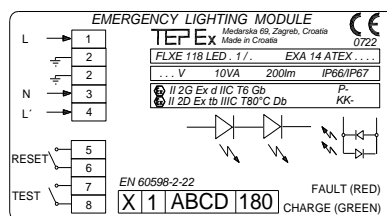
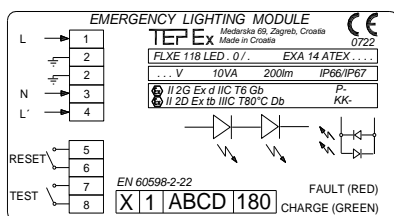

- data according to model code
- manufacturer data : - production number,  
 - number of a single examination,  
 - date,  
 - responsible person