



POWER NETWORK PARAMETER ANALYSER N10



SERVICE MANUAL



POWER NETWORK PARAMETER ANALYSER N10

Service manual

1. APPLICATION.....	5
2. METER SET	5
3. INSTALLATION.....	6
3.1. FITTING	6
3.2. EXTERNAL CONNECTION DIAGRAMS.....	7
4. PROGRAMMING	12
4.1. FACEPLATE DESCRIPTION.....	12
4.2. N10 OPERATING MODES	14
4.2.1 MEASURING MODE	15
4.2.1.1. Measurement of voltage and current harmonics.....	16
4.2.2. TIME SETTING MODE - t	17
4.2.3. PARAMETER CONFIGURATION MODE - S	18
4.2.4. ALARM CONFIGURATION MODE - A	20
4.2.5. PAGE CONFIGURATION MODE - P	22
5. ERROR CODES.....	25
6. TECHNICAL DATA	27
7. ORDERING CODES	30
8. MAINTENANCE AND GUARANTEE	31

1. APPLICATION

The N10 type meter is a programmable digital instrument destined to measure parameters in three-phase, 3 or 4-wire power networks, in symmetric and asymmetric systems with the simultaneous display of measured quantities and the digital transmission of their values and their conversion into an analog standard signal.

This meter enables the control and optimization of power electronic devices, systems and industrial installations. It ensures the measurement of: RMS voltage and current, active power and energy, reactive power and energy, power factors, frequency, 15-minutes active mean powers. Voltages and currents are multiplied by given voltage and current ratios of voltage and current measuring transformers. Power and energy indications take into consideration values of programmed ratios. This meter indicates additionally the actual time. The value of each measured quantity can be transmitted to the superordinated system through the RS-485 interface. One of the chosen quantity can be additionally transmitted by means of a standard current signal, three relays outputs can be used to signalize exceedings of chosen quantities, a pulse output to control energy counters with pulse inputs, and a pulse input to check counters having pulse outputs. Measurements are carried out by the sampling method of voltage and current signals. The meter is adapted to be fixed into a panel by means of holders.

2. METER SET

The set includes:

- N10 type meter 1 pc.
- service manual 1 pc.
- guarantee card 1 pc.
- holders to fix into a pannel 4 pcs.

Additionally for the execution with interface:

- service manual of the serial interface 1 pc.
- service manual of the WIZPAR program 1 pc
- lead of the RS-485 interface 1 pc.
- matching resistor 1 pc.
- diskette for the WIZPAR program 1 pc.

3. INSTALLATION

3.1. Fitting way

The meter is adapted to be mounted by means of holders according to fig. 1.

The meter housing is made of a self-extinguishing plastic.

Housing dimensions are 144 x 144 x 77mm. At the outside of the meter there are screwed terminal strips which enable the connection up to 2.5 mm² external leads.

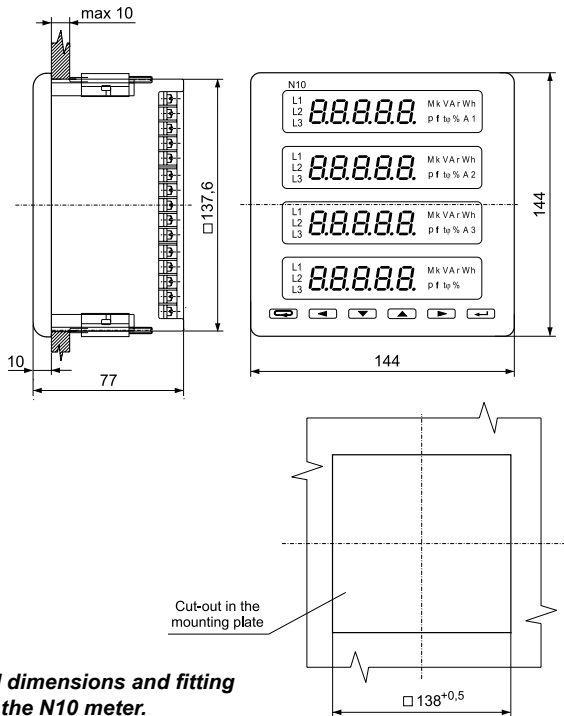
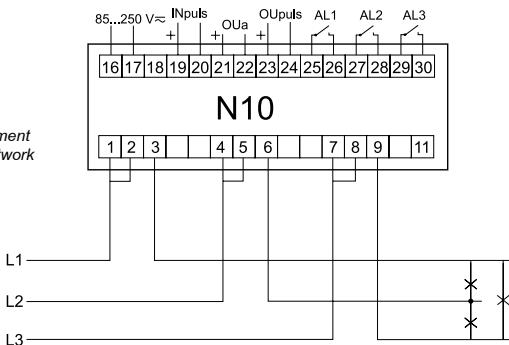

Fig. 1.
Overall dimensions and fitting way of the N10 meter.

3.2. External connection diagrams

*Direct measurement
in a 3-phase network*



*Half-intermediate
measurement
in a 3-phase network*

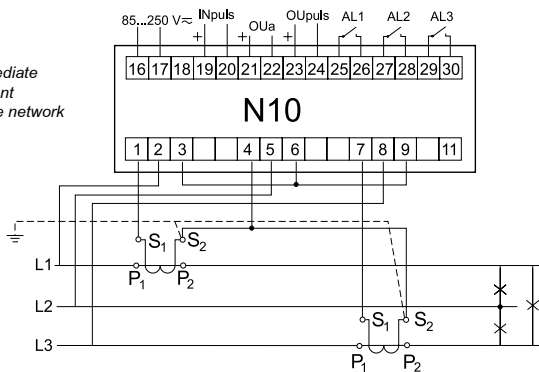

Intermediate measurement using
2-current transformers and 2 or 3
voltage transformers
in a 3-phase network

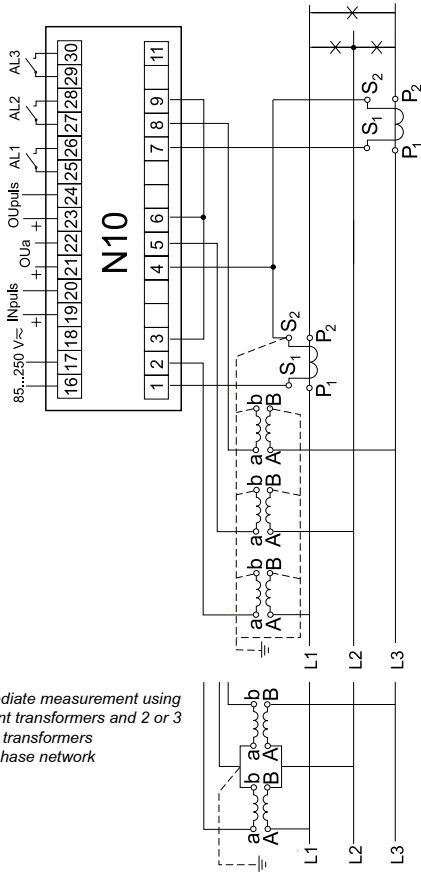
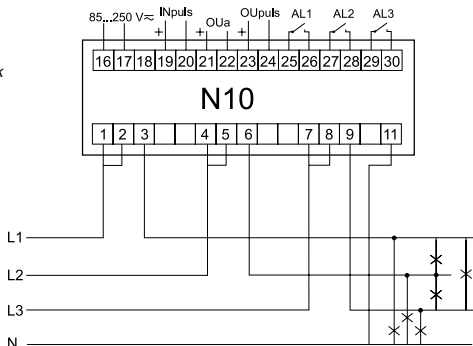
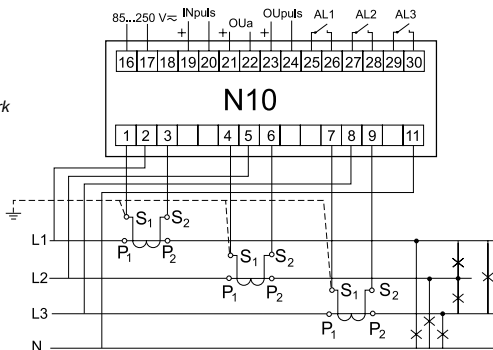

Fig. 2. Meter connection diagrams in a three-phase network

*Direct measurement
in a 4-phase network*



*Half-intermediate
measurement
in a 4-wire network*



Intermediate measurement using
2-current transformers and 2 or 3 voltage
transformers in a 3-phase network

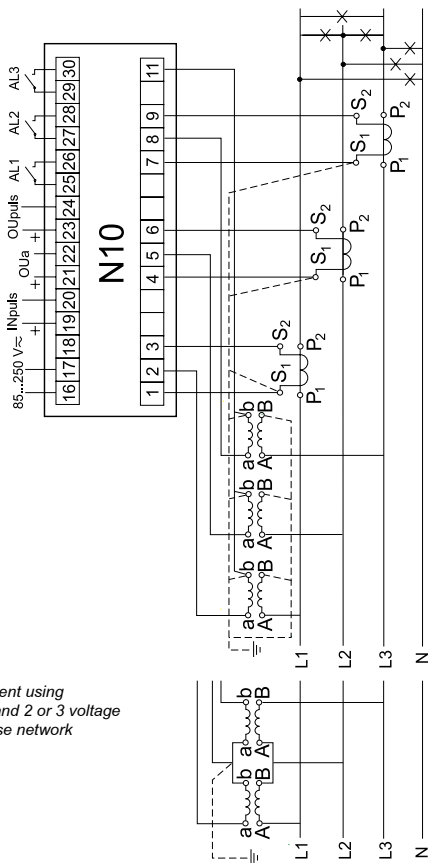

Fig. 3. Meter connection diagrams in a four-wire network

NOTICE:

To make the IBM PC - N10 meter (RS-485) connection it is recommended to use a double-wire twisted conductor in a screen. The screen should be connected to the earth in one point.

The screening is necessary when the environment is very perturbed.

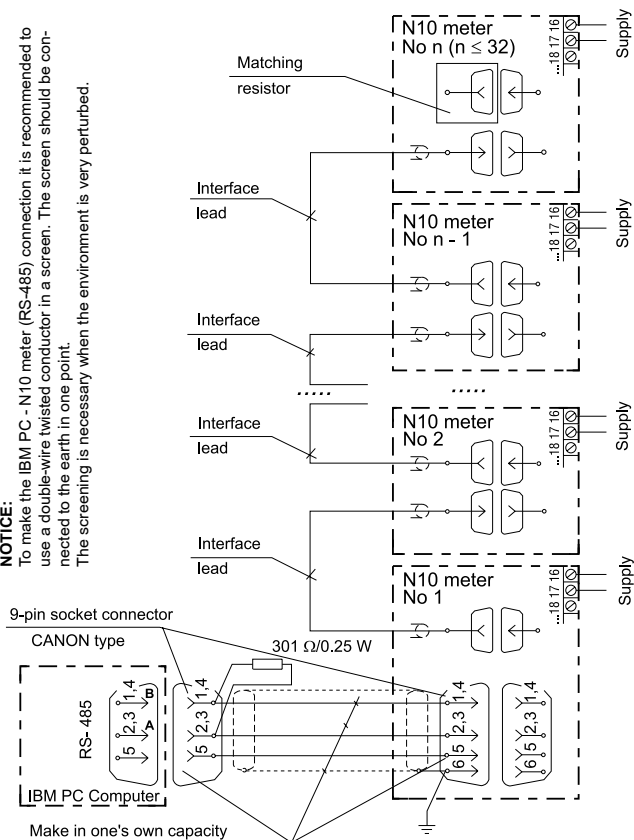

Fig. 4. Connecting way of N10 meters with an RS-485 interface.

4. PROGRAMMING

4.1. Faceplate description

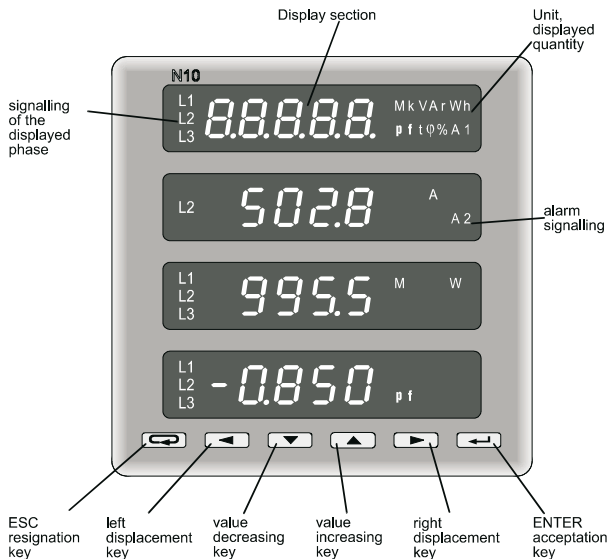









Fig. 5. View of the N10 meter faceplate

The N10 meter has 6 keys, four 5-digits display sections and illuminated symbols and parameter units. Values of measured parameters are shown on active pages selected by successive pressures of the  key.

A page consists of 4 optional quantities chosen from the table 5 and displayed simultaneously on the meter.

The page definition is described in the configuration mode P.

Table 1

1		ENTER acceptance key
2		Right displacement key
3		Value increase key
4		Value decrease key
5		Left displacement key
6		ESC resignation key

The assignment of individual keys is as follows:



It is destined to accept the introduced value during the programming. It enables the change of pages in the measuring mode.



They are destined to change the digit value on the decimal position during the programming. They enable the display of suitably minimal and maximal values.



They allow the cursor displacement to successive decimal positions during the programming and enable the change of display luminosity.











This key enables in anytime the resignation of carried out operations. It cancels alarms in measuring mode.

4.2. N10 operating modes

The N10 meter has 5 operating modes represented on the table 2.

Table 2

MODE			
NAME	CALLING OUT SYMBOL	INPUT	OUTPUT
Measuring		Understood	Through input to another mode
Time setting	t	in SETUP procedure	 or  after the last parameter
Page configuration	P	in SETUP procedure	 or  after the last parameter
Parameter configuration	S	in SETUP procedure	 or  after the last parameter
Alarm configuration	A	in SETUP procedure	 or  after the last parameter



After its switching on, the meter makes tests informing by the announcement:

	n	-	1	0
_	h	2.0	2	



where: h2.02 - No of the actual program version,



After tests carrying out, the meter enters into the measuring mode and displays the page positioned before switching off.

The entry into another mode is made in the SETUP procedure. In order to enter in the SETUP procedure one should press two keys:

  during ca 3 seconds, until the audible signal will be switched off.

	S			t
	E			<u>P</u>
	t			S
				A

Choose by means of   keys the appropriate mode. The active mode **t**, **P**, **S** or **A** is signalled by the flashing of the suitable symbol. Accept the chosen mode by the  key.







The return from other modes into the measuring mode is carried out by means of the  or  key:

- after the last parameter (in t, S and A modes),
- after the last page (in the P mode).

4.2.1. Measuring mode





Values of different quantities are displayed acc. programmed pages by the manufacturer or configured by the user in the **P** mode.

The change of page is realized by pressing the  Key. The sequence of displayed pages is proceeded acc. the table formed in the **P** mode.

The monitoring of maximal or minimal values is realized when pressing respectively the  or  key. The cancellation of maximal or minimal values is realized when pressing the  key during the monitoring of these values, i.e. at first the  or  key must be pressed and after the  key.



Alarms are active if they were allocated. One must notice that alarm do not need to be related to quantities displayed on the page, because a change of page would cause an action on two-state outputs.

4.2.1.1. Measurement of voltages and current harmonics

The selection of harmonics is made by pressing   keys for reviewing current harmonic, or by   keys for reviewing voltage harmonics.





	H		I	1
	A		I	<u>2</u>
	r		I	3

	H		U	1
	A		U	<u>2</u>
	r		U	3

The selected U1,U2,U3 or I1,I2, I3 quantity is signalled by the flashing of the suitable digit. One must choose by the  or  key the required quantity and press the  key. The following quantities will be displayed:

		w	-	n
	h		n	<u>n</u>
	x	x	x.	x

Where: w-n - chosen quantity, e.g. U-1
 n-n - harmonic number
 xxx.x - value of the n-th harmonic



The harmonic number up to the 25th harmonic can be changed by means of  or  keys. The active position is signalled by the cursor. One can return to display the selection of reviewed harmonics by pressing the  key. A successive pressure of the  key means the return to the measuring mode.

For wrong THD indications, successive harmonic values will not be displayed.

NOTICE:











Indications appear when the parameter 22 will be switch on in the SETUP mode, i.e. the selection of the harmonic measurement and the assumptions concerning the measurement will be fulfilled.

4.2.2. Setting time mode - t

After the entry into the SETUP procedure one must choose the mode t by pressing the  or  key and the  key. Following values will be displayed:

	y	y	y	y
			m	m
			d	d

Where: yyyy - year
mm - month
dd - day

By means of     keys required values can be set, i.e. the position of the decimal digit can be chosen by the  or  key, the digit value by the  or  key. The cursor signalizes the active position. The set value can be accepted by the  key or cancelled by the  key and comes back into the measuring mode.

 causes the arrangement on the successive parameter.

 after dd (day), causes the transition to hours and minutes settings.

			h	h
			m	m
			s	s

Where: hh - hours
mm - minutes
ss - secondes

The setting of hours and minutes is similar to the setting of the year, month and day.

 after min (minutes), causes the memorization of set values and the exit from the mode t.

The seconde counter is not be set but it is zeroed when accepting minutes. This means that in order to obtain an accurate timer setting one must wait till a full minute and then press the  key (ENTER).

4.2.3. Parameter configuration mode - S

This mode is destined to set meter parameters, input and output signal values. The entry into the parameter configuration mode is protected by the access code if an access code different from zero had been introduced.

In the case of 0000 code, password inquiry is omitted. If the access code is different from zero, there is the possibility of parameter reviewing, but changes are locked.

Values are set in this mode acc. the table 3.

Table 3

Item	Parameter name	Designation	Range	Notice/description	Manufacturer's values
1	Introduction of access code	SECU	0000...9999	0000 -without code	0000
2	Setting of meter parameters by the manufacturer	rEst		Y/n	n
3	Ratio of current transformer	tr_I	1...20000		1
4	Ratio of voltage transformer	tr_U	1...4000		1
5	Quantity on the continuous output	Ao_n	0...34	Quantity code acc. table 5	1
6	Factor of output rescaling		Ao_L	80...120%	100
7	Range of the continuous output	Ao_0	0,4	0 - 0...20mA 4 - 4...20mA	4









Table 3



8	Quantity on the pulse output	Po_n	0, 35...37	Quantity code acc. table 5	35
9	Constans of the pulse output	Po_c	0...9999	Pulse number/ 1kWh,kVar,kVAhmax 2 pulses/sec.	1000
10	Quantity on the pulse input	PI_n	0, 38...40	Quantity code acc. table 5	38
11	Constant of the external energy counter (pulse input)	PI_c	1...9999	Pulse number/ 1kWh,kVarh,kVAh	1000
12	Cancellation of the external energy counter (counter of the pulse input)	PI_0		Y/n	n
13	Cancellation of the active energy counter	EnP0		Y/n	n
14	Cancellation of the reactive energy counter	Enq0		Y/n	n
15	Cancellation of the apparent energy counter	EnS0		Y/n	n
16	Cancellation of the 15-minutes active power PAV (max. and min. Value)	PA_0		Y/n	n
17	Averaging time of PAV power	PA_t	15, 30, 60 min.		15
18	Synchronization of the PAV power averaging to the real timer	PA_S		Y/n	n
19	Meter address in the system	Adr	1...247		1
20	Rate of the serial interface	bAUd	300,600,..., 19200		9600
21	Interface working modetr	trYb	0, 1, ...,6	0-switched off interface 1-MODBUS ASCII 8N1 2-MODBUS ASCII 7E1 3-MODBUS ASCII 7O1 4-MODBUS RTU 8N2 5-MODBUS RTU 8E1 6-MODBUS RTU 8O1	0
22	Selection of the harmonic measurement	Har	0.1		0
23	Change of the access code		0000...9999		0000

In parameters 5, 8, 10, 21 the range 0 means that the appropriate output, input is switched off.

Notations:

- N - lack of parity (no parity),
- E - bit checking the even parity,
- O - bit checking the odd parity.

The entry into the procedure causes the setting on the parameter 1 or 2 if the access code is equal 0000. We adjust required values by means of     keys, i.e. one can choose the position of the decimal digit by pressing the  or  key, the digit value by pressing the  or  key. The active position is signalled by the cursor.

One can accept the established value by pressing the  key or cancel it by pressing the  key and come back to the measuring mode.

 causes the setting on the successive parameter.

 after the last parameter, causes the memorization of setting values and the exit from the mode S.

Notice:

PA_S=Y means that the average power P_{AV} will be brought up to date every 15, 30, or 60 minutes synchronized with the internal virtual timer.

PA_S=n means that the average power will be calculated for the last 15, 30, or 60 minutes and brought up to date every 1 seconde, so-called „moving window”.

4.2.4. Alarm configuration mode - A

This mode serves to:

- attribute the quantity to alarms,
- Set the thresholds setting of alarm switching on and off (also the direction of alarm action).

Table 4

Item	Parameter name	Designation	Range	Notice/description	Manufacturer's values
1	Two state output 1-quantity	A1_n	0, 1...34	Quantity code acc. table 5	2
2	Two state output 1-switch on value	A1on	0...120 [%]		101
3	Two state output 1-switch off value	A1oF	0...120 [%]		99
4	Two state output 2-quantity	A2_n	0, 1...34	Quantity code acc. table 5	9
5	Two state output 2-switch on value	A2on	0...120 [%]		101
6	Two state output 2-switch off value	A2oF	0...120 [%]		99
7	Two state output 3-quantity	A3_n	0, 1...34	Quantity code acc. table 5	16
8	Two state output 3-switch on value	A3on	0...120 [%]		101
9	Two state output 3-switch off value	A3oF	0...120 [%]		99
10	Delay of alarm action	ALdt	0...100 sec	Time lag of alarm switching on	0

The entry into the mode of alarm setting is not protected by the access code.

Alarms are active if they were attributed, i.e. if a measured quantity different than zero (table 5) has been attributed to them. One must notice that alarms concern chosen quantities in the basic configuration mode **S** and they are not related with quantities displayed on the page. If the quantity value related to the alarm exceeds the declared threshold, the two-state output corresponding to this alarm will be switched on (relay) and the symbol A_i will be lighted. If the quantity value decreases below the alarm threshold, the two-state output is switched off, but the A_i signalling remains until the time of its cancellation by means of the **ESC** key.

The $A_{ion} < A_{ioF}$ setting causes the alarm inverse action, i.e. the output is switched on if the prescribed value decreases below the A_{ion} value and the output is switched off if the value increases above the A_{ioF} threshold.

4.2.5. Page configuration mode - P

This mode is used to select quantities displayed simultaneously on the meter, i.e. to define user's pages.

A list of possible quantities and their codes are inserted in the table 5.

Table 5.

Code	Quantity name	Symbol	Unit	Signal- ling	Mark
00	Without quantity - display extinguished				
01	Phase 1 voltage	U_1	(k)V	L1	
02	Line L1 current	I_1	(k)A	L1	
03	Phase L1 active power	P_1	(M,k)W	L1	/-
04	Phase L1 reactive power	Q_1	(M,k)VA _r	L1	/-
05	Phase L1 apparent power	S_1	(M,k)VA	L1	
06	Phase L1 active power factor ($Pf_1 = P_1 / S_1$)	Pf_1	Pf	L1	/-
07	Phase L1 φ_1 factor ($\varphi_1 = Q_1 / P_1$)	φ_1	φ	L1	/-
08	Phase L2 voltage	U_2	(k)V	L2	
09	Line L2 current	I_2	(k)A	L2	
10	Phase L2 active power	P_2	(M,k)W	L2	/-
11	Phase L2 reactive power	Q_2	(M,k)VA _r	L2	/-
12	Phase L2 apparent power	S_2	(M,k)VA	L2	
13	Phase L2 active power factor ($Pf_2 = P_2 / S_2$)	Pf_2	Pf	L2	/-
14	Phase L2 φ_2 factor ($\varphi_2 = Q_2 / P_2$)	φ_2	φ	L2	/-
15	Phase 3 voltage	U_3	(k)V	L3	
16	Line L3 current	I_3	(k)A	L3	
17	Phase L3 active power	P_3	(M,k)W	L3	/-
18	Phase L3 reactive power	Q_3	(M,k)VA _r	L3	/-
19	Phase L3 apparent power	S_3	(M,k)VA	L3	
20	Phase L3 active power factor ($Pf_3 = P_3 / S_3$)	Pf_3	Pf	L3	/-
21	Phase L3 φ_3 factor ($\varphi_3 = Q_3 / P_3$)	φ_3	φ	L3	/-
22	Average 3-phase voltage	U_s	(k)V	1,2,3	
23	Average 3-phase current	I_s	(k)A	L1,L2,L3	

24	3-phase active power	P	(M,k)W	L1,L2,L3	/-
25	3-phase reactive power	Q	(M,k)VA _r	L1,L2,L3	/-
26	3-phase apparent power	S	(M,k)VA	L1,L2,L3	
27	Active power factor (Pf= P/ S)	Pf	Pf	L1,L2,L3	/-
28	Average 3-phase t(factor (t _φ = Q/P)	t _φ	t _φ	L1,L2,L3	/-
29	Frequency	f	Hz		
30	Voltage between lines L1-L2	U ₁₂	(k)V	L1,L2	
31	Voltage between lines L2-L3	U ₂₃	(k)V	L2,L3	
32	Voltage between lines L3-L1	U ₃₁	(k)V	L3,L1	
33	Average between lines voitage	U ₁₂₃	(k)V	L1,L2,L3	
34	15-minutes average active power	PAV	(M,k)W	1, 2, 3	
35	3-phase active energy	EnP	(M,k)Wh	L1,L2,L3	/-
36	3-phase reactive energy	Enb	(M,k)VA _r h	L1,L2,L3	/-
37	3-phase apparent energy	EnS	(M,k)VA _h	L1,L2,L3	
38	Active energy from external counter	EnPz	(M,k)Wh		
39	Reactive energy from external counter	Enbz	(M,k)VA _r h		
40	Apparent energy from external counter	EnSz	(M,k)VA		
41	Date - day, month				
42	Date - year				
43	Time - hours, minutes				
44	Time - secondes				
45	THD of the phase L1 voltage	THD U1	V%	L1	
46	THD of the phase L2 voltage	THD U2	V%	L2	
47	THD of the phase L3 voltage	THD U3	V%	L3	
48	THD of the phase L1 current	THD I1	A%	L1	
49	THD of the phase L2 current	THD I2	A%	L2	
50	THD of the phase L3 current	THD I3	A%	L3	

In the case of parameters 40...50, the denominations V and A have got a conventional character distinguishing the given parameter, the basic quantity in %.

In order to define pages one must enter into the mode **P**.

	P	A	G	n
			n	n

By pressing     keys set the number nn of user's pages from the range 00...20. Accept by the  key the chosen mode.

If the number of pages is set 00, it means that the user did not decide to define own pages and chose 7 pages programmed by the manufacturer. Manufacturer's settings are shown below:



Page 1	Page 2	Page 3	Page 4
01 U ₁ (k)V	30 U ₁₂ (k)V	02 I ₁ (k)A	03 P ₁ (Mk)W
08 U ₂ (k)V	31 U ₂₃ (k)V	09 I ₂ (k)A	10 P ₂ (Mk)W
15 U ₃ (k)V	32 U ₃₁ (k)V	16 I ₃ (k)A	17 P ₃ (Mk)W
22 U _s (k)V	33 U ₁₂₃ (k)V	23 I _s (k)A	24 P (Mk)W
Page 5	Page 6	Page 7	
24 P (Mk) W	35 EnP (Mk) Wh	41 dd.mm	
25 Q (Mk) VAr	36 EnB (Mk) VArh	42 yyyy	
26 S (Mk) VA	37 EnS (Mk) VAh	43 hh.mm	
27 Pf	38 f	44 ss	

If a non-zero number of pages has been set then one must define the page contents.

nn - page number
 kk - quantity code acc.
 to the table 5.

	P		k	k
	G		k	k
	n		k	k
	n		k	k

By pressing     keys, set required quantities on successive display sections.

The active position is signaled by the cursor. One can accept the established value by the  key or cancel it by pressing the  key.

 causes the setting on the next parameter or the successive page.

 after the last page, causes the memorization of pages and the exit from the configuration mode **P**.

5. ERROR CODES

During the meter operation, communicates concerning errors can occur.

Causes of errors are presented below:

Err1 - when the voltage or the current is too low during the measurement:

$Pf_i, t\phi_i$ below 7% U_n

and (or) below 2% I_n

f below 0,5%

THD U_i , THD I_i , below 1% U_n, I_n

- or the full interval of the PA_t averaging time is not elapsed yet,

Err2 - Lack of possibility to define the maximal or minimal quantity value (lack of current, usually after the meter switching on or the cancellation of extremal values)

Lo F - frequency lower than 47 Hz for THD U_i , THD I_i measurements,

Hi F - frequency higher than 52 Hz for THD U_i , THD I_i measurements.

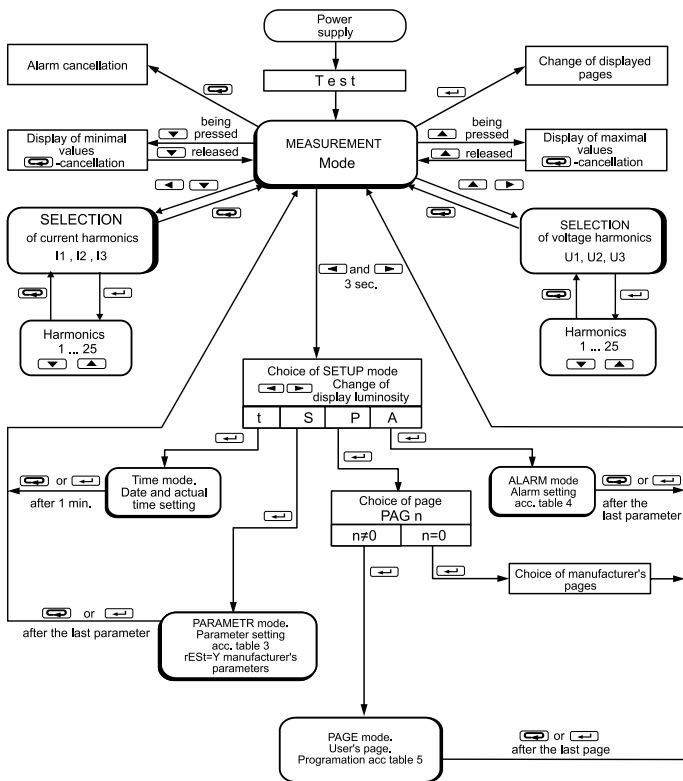

Fig.6 N10 meter working modes.

6. TECHNICAL DATA

Measuring ranges and admissible basic errors are shown on the table 6

Table 6

Measured quantity	Range	Basic error	remarks
U_i voltage	100.0 V ($K_u=1$) 400.0 V ($K_u=1$) for $K_u \neq 1 \dots 400.0$ kV	$\pm (0.2\% \text{ m.v.} + 0.1\% \text{ range})$	$K_u = 1 \dots 4000$
I_i current	1.000 A ($K_i=1$) 5.000 A ($K_i=1$) for $K_i \neq 1 \dots 20.00$ kA	$\pm (0.2\% \text{ m.v.} + 0.1\% \text{ range})$	$K_i = 1 \dots 20000$
P_i active power P_{AV} mean active power Active energy EnP , $EnPz$	0.0... (-)1999.9 W (Wh) for $K_u \neq 1, K_i \neq 1$...(-)1999.9 MW (MWh)	$\pm (0.5\% \text{ m.v.} + 0.2\% \text{ range})$	
S_i apparent power. Apparent energy $EnS, EnSz$	0.0... 1999.9 VA (VAh) for $K_u \neq 1, K_i \neq 1$...1999.9 MVA (MVAh)	$\pm (0.5\% \text{ m.v.} + 0.2\% \text{ range})$	
Q_i reactive power. Reactive energy $EnQz$	0.0... (-)1999.9 Var (Varh) for $K_u \neq 1, K_i \neq 1$ (-)1999.9 MVar (MVarh)	$\pm (0.5\% \text{ m.v.} + 0.2\% \text{ range})$	
Pf_i active power factor	- 1.00 ...0.00 ...1.000	$\pm 1\% \text{ m.v.} \pm 2c$	$Pf = \text{Power factor} = P/S$
$tg\phi_i$ factor (ratio of reactive power to active power)	- 99.9...0...99.9	$\pm 1\% \text{ m.v.} \pm 2c$	Error in the range: - 99.9...0...99.9
f frequency	15.0... 500.0 Hz	$\pm 0.5\% \text{ m.v.}$	
THD U, THD I harmonics	0.2... 200%	$\pm 0.5\% \text{ m.v.} \pm 2c$	Error in the range: 10...120% U, I 47... 52 Hz

Where: K_u - voltage transformer ratio

K_i - current transformer ratio

m.v. - measured value

c - less significant display digit

THD U - full distortion factor (by voltage harmonics)

THD I - full distortion factor (by current harmonics)

Power consumption:	
- supply circuit	≤ 12 VA
- voltage circuit	≤ 0.5 VA
- current circuit	≤ 0.1 VA
Supply voltage	85...250 V d.c. or a.c., 40...400 Hz
Display section	4 x 5 LED digits, 14 mm high red or green digits
Analog output	0...20 mA, (4...20 mA) selected from the keyboard, accuracy 0.5%
Relay output	3 relays, voltageless make contacts, Load capacity 250 V a.c./ 0.5 A~
Passive pulse output	0...2 Hz 12...50 V d.c. (5...20 mA)
Passive pulse input	0/24 V d.c. ±50%,
Measurement of the harmonics (Up to the 25 th)	for currents and voltages
THD - Total Harmonic Distortion	for currents and voltages
Serial interface	RS-485
Transmission protocol	MODBUS
Meter reaction to decays and supply recovery:	<ul style="list-style-type: none"> ● data and meter state preservation during supply decays, (battery support), ● work continuation after supply recovery
Degree of protection ensured by the case acc. IEC529:	
- frontal side	IP 40
- rear side	IP 10
Weight	0.8 kg
Overall dimensions	144 × 144 × 77 mm
Panel cut-out dimensions	138 ^{+0.5} × 138 ^{+0.5}

Reference conditions and nominal operation conditions:

- Input signal: 0...0.01...1.2 In; 0...0.01...1.2 Un, for voltage, current, frequency, power and energy
0...0.02...1.2 In; 0...0.07...1.2 Un, for Pf and t_p factors, frequency 15...45...65...500 Hz
sinusoidal input signal THD $\leq 8\%$
0.1...1.2 In; 0.1...1.2 Un; 47... 52 Hz, for THDU, THDI and harmonics
- power factor - 1...0...1
- ambient temperature 0...23...55°C
- air humidity 25...95% (no condensation)
- power supply 85... 253 V d.c. or a.c. 40... 400 Hz
- admissible peak factor:
 - current 2
 - voltage 2
- external magnetic field 0...40...400 A/m
- short duration overload (5 sec):
 - voltage inputs 2 Un (max.1000 V)
 - current inputs 10 In
- working position optional
- warm-up time 5 minutes

Additional errors in % of the basic error:

- input signal frequency < 50%
- ambient temperature changes < 50%/10°C

Resistance against supply decays acc. to EN 61000-6-2

Standards fulfilled by the meter:

Electromagnetic compatibility:

- immunity acc. EN 61000-6-2
- emission acc. EN 61000-6-4

Safety requirements:

- acc. EN 61010-1
- insulation ensured by the housing dual
- insulation between circuits basic
- installation category III
- pollution degree 2
- maximal working voltage in relation to ground 600 V a.c.

7. ORDERING CODES

Execution codes for the N10 network parameter meter

Table 7

NETWORK PARAMETER METER	N10	X	X	X	X	X	XX	X
Input current I_n:								
1 A (X/1)		1						
5 A (X/5)		2						
acc. order *		9						
Input phase voltage U_n:								
100 V			1					
400 V			2					
acc. order *			9					
Digital output:								
without interface				0				
with RS 485 interface				1				
Display:								
red digits					1			
green digits					2			
Power supply:								
85...250 V d.c. or a.c. 40...400 Hz						0		
acc. order*						9		
Kind of execution:								
standard							00	
custom-made							99	
Acceptance tests:								
without additional requirements								8
with a quality inspection certificate								7
acc. customer's agreements **								X

* after agreement with the manufacturer

** the execution numbering will be made by manufacturer

ORDERING EXAMPLE:

code **N10 2 1 1 2 0 00 1**-means: input range: 5 A, 100 V, RS-485 interface, green displays, power supply: 85...250 V d.c./a.c., standard execution, with a quality inspection certificate.

8. MAINTENANCE AND GUARANTEE

The N10 meter does not require any periodical maintenance.
In case of some incorrect unit operations:

1. In the period of 12 months from the date of purchase:

One should take the meter down from the installation and return it to the LUMEL's Quality Control Dept.

If the unit has been used in compliance with the instructions, LUMEL S.A. guarantees to repair it free of charge.

2. After the warranty period:

One should turn over the meter to repair in a certified service workshop.

The disassembling of the housing causes the cancellation of the granted guarantee.

Spare parts are available for the period of ten years from the date of purchase.

LUMEL S.A. reserves the right to make changes in design and specifications of any products as engineering advances or necessity requires.

SALES PROGRAM

- DIGITAL and BARGRAPH PANEL METERS
- MEASURING TRANSDUCERS
- ANALOG PANEL METERS (DIN INSTRUMENTS)
- ANALOG and DIGITAL CLAMP-ON METERS
- INDUSTRIAL and HOUSEHOLD CONTROLLERS
- CHART AND PAPERLESS RECORDERS
- POWER CONTROL UNITS and INVERTERS
- LARGE SIZE NUMERIC and ALPHANUMERIC DISPLAYS
- AUTOMOTIVE DASHBOARD INDICATORS
- ACCESSORIES FOR MEASURING INSTRUMENTS
- MEASURING SYSTEMS (ENERGY, HEAT, CONTROL)
- CUSTOM-MADE PRODUCTS

MEASUREMENT CONTROL RECORDING

WE ALSO OFFER OUR SERVICES IN THE PRODUCTION OF:

- ALUMINIUM ALLOY PRESSURE CASTINGS
- PRECISION ENGINEERING AND THERMOPLASTICS PARTS
- PRESSURE CASTING DIES AND OTHER TOOLS

QUALITY PROCEDURES:

According to ISO 9001 and ISO 14001 international requirements.

All our instruments have CE mark .

For more information, please write to or phone our Export Department



Lubuskie Zakłady Aparatów Elektrycznych LUMEL S.A.

ul. Sulechowska 1

65-022 Zielona Góra - Poland

Tel.: (48-68) 329 51 00 (exchange)

Fax: (48-68) 329 51 01

e-mail: lumel@lumel.com.pl

<http://www.lumel.com.pl>

Export Department:

Tel.: (48-68) 329 53 02 or 04

Fax: (48-68) 325 40 91

e-mail: export@lumel.com.pl