

CX-2

user manual

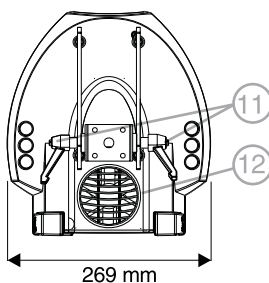

- 1 focus lens
- 2 cover locks
- 3 air vent
- 4 safety cable holes
- 5 mounting bracket
- 6 air vents
- 7 AC input & main fuse
- 8 DIP-switch
- 9 data output
- 10 data input
- 11 swivel locks
- 12 cooling fan

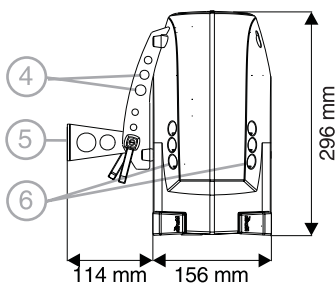
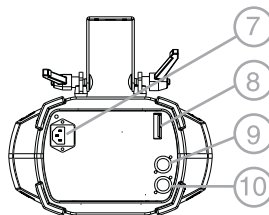
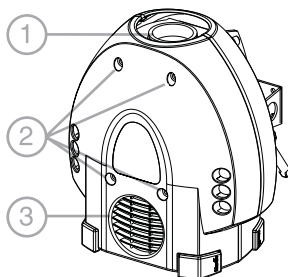

©1999, 2000 Martin Professional A/S, Denmark.

All rights reserved. No part of this manual may be reproduced, in any form or by any means, without permission in writing from Martin Professional A/S, Denmark.

Printed in Denmark.

P/N 35000080, Rev. C

Introduction	4
Lamp	6
AC power connection	7
Installation	9
Data connection	10
Stand-alone operation	11
MC-1 operation	13
DMX operation	14
Basic service	17
Troubleshooting	19
DMX protocol	20
Specifications	22

INTRODUCTION

Thank you for selecting the Martin CX-2. The CX-2 is an automated profile spotlight designed for a 250 watt halogen source. It provides separate color and gobo/effect wheels, continuous electronic dimming, adjustable focus, strobe effects, and multiple control options.

CX-2 SAFETY INFORMATION

Warning! *This product is for professional use only. It is not for household use.*

This product presents risks of lethal or severe injury due to fire and heat, electric shock, and falls. **Read this manual** before powering or installing the fixture, follow the safety precautions listed below and observe all warnings in this manual and printed on the fixture. If you have questions about how to operate the fixture safely, please contact your Martin dealer or call the Martin 24-hour service hotline at +45 70 200 201.

To protect yourself and others from electric shock

- Disconnect the fixture from AC power before removing or installing the lamp, fuses, or any part, and when not in use.
- Always ground (earth) the fixture electrically.
- Use only a source of AC power that complies with local building and electrical codes and has both overload and ground-fault protection.
- Do not expose the fixture to rain or moisture.
- Refer any service operation not described in this manual to a qualified technician.
- Never operate the fixture with missing or damaged lenses and/or covers.

To protect yourself and others from burns and fire

- Never attempt to bypass the thermostatic switch or fuses. Always replace defective fuses with ones of the specified type and rating.
- Keep all combustible materials (for example fabric, wood, paper) at least 0.1 meters (4 inches) away from the fixture. Keep flammable materials well away from the fixture.
- Replace the lamp if it becomes defective or worn out. When replacing the lamp, allow the fixture to cool for at least 5 minutes before opening the fixture or removing the lamp. Protect your hands and eyes with gloves and safety glasses.
- Do not illuminate surfaces within 0.3 meters (12 inches) of the fixture.
- Provide a minimum clearance of 0.1 meters (4 inches) around fans and air vents.
- Never place filters or other materials over the lens.
- The exterior of the fixture can reach temperatures up to 65° C (149° F). Allow the fixture to cool for at least 5 minutes before handling.
- Do not modify the fixture or install other than genuine Martin parts.
- Do not operate the fixture if the ambient temperature (Ta) exceeds 40° C (104° F).

To protect yourself and others from injury due to falls

- When suspending the fixture above ground level, verify that the structure can hold at least 10 times the weight of all installed devices.
- Verify that all external covers and rigging hardware are securely fastened and use an approved means of secondary attachment such as a safety cable.
- Block access below the work area whenever installing or removing the fixture.

UNPACKING

The packing material is carefully designed to protect the fixture during shipment - always use it to transport the fixture.

The CX-2 comes with:

- 1 3-meter, 3-wire IEC power cable
- 1 user manual

LAMP

2

The CX-2 uses a 24V, 250W ELC halogen lamp. Two models are available, an economical 300 hour lamp from Philips and a high-output 50 hour lamp from Osram. Installing any other lamp may damage the fixture.

Allow the lamp to cool for at least 5 minutes before packing and moving the fixture. To avoid possible damage, remove the lamp when shipping the fixture.

To install a lamp in the CX-2

Warning! *Always disconnect the fixture from AC power and allow the fixture to cool for 5 minutes before installing a new lamp.*

- 1 Disconnect the fixture from AC power. If replacing a hot lamp, allow it to cool for 5 minutes before removing the cover. The lamp cools faster with the cover in place.
- 2 Release the 4 cover locks by turning them a quarter-turn counterclockwise. Lift the cover straight off.
- 3 To remove the lamp, grasp it by the reflector and pull it out of the holder. Pull the socket straight back off the metal pins. Do not pull the wires.
- 4 Push the socket fully onto the pins of the new lamp.
- 5 Gently push the lamp into the holder until it snaps into place.
- 6 Replace the top cover. To lock the 4 cover locks, turn them a quarter to a half turn clockwise until you feel them click. *Do not overtighten.*

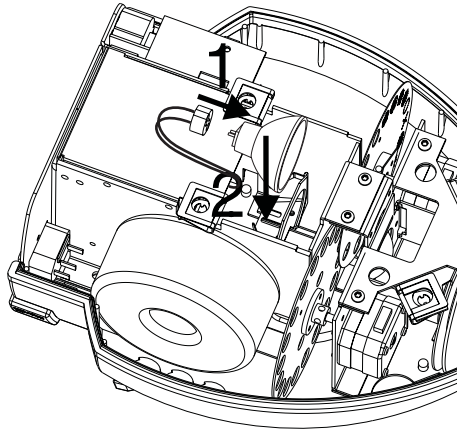

AC POWER CONNECTION

Warning! For protection from dangerous electric shock, the fixture must be grounded (earthed). The AC mains supply shall have overload and ground-fault protection.

Important! Check voltage setting before applying power. Do not connect the CX-2 to an electrical dimmer system: doing so can damage the electronics.

Before use verify that the fixture's power supply is correctly tapped for the local AC voltage. The default voltage setting is printed on the serial number label near the AC input. The "EU" version may be set to 230 or 245 V AC and the "US" version may be set to 110 or 120 V AC. Use the setting that is closest to the local supply voltage.

To change the voltage setting

- 1 Disconnect the fixture from AC power. Release the 4 cover locks by turning them a quarter-turn counterclockwise. Lift the cover straight off.
- 2 Locate and disconnect plug PL124 on the back edge of the printed circuit board. It has red, yellow, and blue wires.
- 3 To select 230 V AC (EU version) or 110 V AC (US version), flip and move the plug *up* so that the *red* wire connects to the *top* pin.
- 4 To select 245 V AC (EU version) or 120 V AC (US version), flip and move the plug *down* so that the *red* wire connects to the *bottom* pin.
- 5 Replace the top cover before applying power.

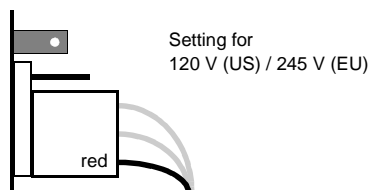
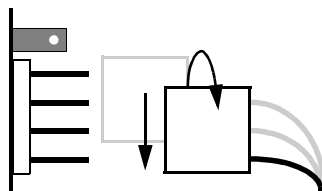
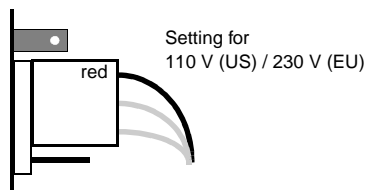

To install a plug on the mains lead

The fixture's mains lead must be fitted with a grounding-type cord cap that fits your power distribution cable or outlet. Consult a qualified electrician if you have any doubts about proper installation.

Important! *Verify that the feed cables are undamaged and rated for the current requirements of all connected devices before use.*

- Following the cord cap manufacturer's instructions, connect the yellow and green wire to ground (earth), the brown wire to live, and the blue wire to neutral. The table below shows some pin identification schemes.

Wire	Pin	Marking	Screw color
brown	live	"L"	yellow or brass
blue	neutral	"N"	silver
yellow/green	ground		green

INSTALLATION

The CX-2 can be fastened directly to a suitable surface or to a rigging clamp by means of its adjustable mounting bracket.

Do not lay the fixture flat on its mounting bracket arms or position it so that there is less than 10 cm (4 in.) clearance around the fan and air vents.

For maximum lamp life, do not place the fixture directly on or beside a speaker cabinet or other source of strong vibrations.

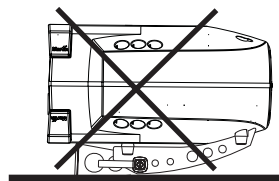

To rig the CX-2

Warning! *Always use a secure means of secondary attachment. Block access below the work area before proceeding.*

- 1 Verify that the clamp (not included) is undamaged and can bear at least 10 times the fixture's weight. Bolt the clamp securely to the bracket with a grade 8.8 (minimum) M12 bolt and lock nut, or as recommended by the clamp manufacturer, through the 13 mm hole in the center of the mounting bracket.
- 2 If permanently installing the fixture, verify that the hardware (not included) and mounting surface can bear at least 10 times the fixture's weight. The four 6.2 mm holes and/or the 13 mm hole in the mounting bracket may be used.
- 3 Verify that the structure can support at least 10 times the weight of all installed fixtures, clamps, cables, auxiliary equipment, etc.
- 4 Working from a stable platform, clamp or fasten the fixture to the structure.
- 5 Install a safety cable that can hold at least 10 times the weight of the fixture through/over the support and through a hole in one of the aluminum arms.
- 6 Loosen the swivel locks and tilt the fixture to the desired angle. Turn the swivel locks clockwise to tighten. If a swivel lock does not tighten fully, pull the handle out, turn it counterclockwise, and retighten. Repeat as necessary.
- 7 Verify that the fixture is located at least 0.3 meters (12 in.) away from the surface to be illuminated and at least 0.1 meters (4 in.) from any combustible materials. Verify that the clearance around the fan and air vents is at least 0.1 meters (4 in.). Verify that there are no flammable materials nearby.

DATA CONNECTION

A reliable data connection begins with the right cable. For best results, use cable specifically designed for RS-485 applications, available from your Martin dealer.

CONNECTIONS

The data sockets are wired with pin 1 to ground, pin 2 to signal - (cold), and pin 3 to signal + (hot) for compatibility with DMX devices. One or more adaptor cables as shown below may be required for connection to the controller or other lights.

5-pin to 3-pin Adaptor		3-pin to 5-pin Adaptor		3-pin to 3-pin Phase-Reversing Adaptor		Male Termination Plug	
Male	Female	Male	Female	Male	Female	Male XLR	
1	1	1	1	1	1	1	120
2	2	2	2	2	2	2	
3	3	3	3	3	3	3	
4			4				
5			5				
P/N 11820005		P/N 11820004		P/N 11820006		P/N 91613017	

To connect the data link

- 1 Connect a cable to the controller's data output. If the output socket has a 5 pins, use a 5-pin male to 3-pin female adaptor. Lead the cable to the first fixture and plug it into the data input.
- 2 Connect the output of the fixture closest to the controller to the input of the next fixture. If connecting to a fixture with reversed-polarity (pin 3 cold), insert a phase-reversing cable between the two fixtures. Continue connecting fixtures output to input. Up to 32 devices may be connected on a serial link.
- 3 Terminate the link by inserting a male termination plug (P/N 91613017) into the data output of the last fixture. A termination plug is simply an XLR connector with a 120 ohm, 0.25 W resistor soldered across pins 2 and 3.

STAND-ALONE OPERATION

The CX-2 may be operated without a controller in stand-alone mode. It may be operated as a single unit or together with other CX-2s in “master/slave” configuration.

Several options are available to modify stand-alone operation. These options are selected using the DIP-switch as described below.

Important! The CX-2 transmits a signal when DIP-switch pins 2 and 10 are set to ON. To avoid damage to the electronics, connect no more than 1 transmitting device (master or controller) to the data link.

SINGLE UNIT OPERATION

The fixture defaults to stand-alone mode with music trigger whenever power is applied and there is no control signal. Options for trigger type, change speed, and lamp intensity may be selected as described under “Stand-alone settings”.

MASTER / SLAVE OPERATION

Multiple CX-2s can be connected together, without a controller, for synchronized “master/slave” operation in which the slaves mimic the behavior of the master, which may be any one of the connected fixtures.

To connect units for master / slave operation

- 1 Connect the output of one CX-2 to the input of the next CX-2.
- 2 Connect additional CX-2s output to input. Up to 32 may be connected.
- 3 Terminate the link on both ends by inserting a *female* termination plug (P/N 91613018) into the data *input* of the first fixture and a *male* termination plug into the data *output* of the last fixture. The female terminator may not be required if the first fixture is the master.

To set the master

Important! Set only 1 fixture as master (DIP-switch pin 2 and 10 ON).

- 1 Set DIP-switch pins 2 and 10 to ON.
- 2 Set DIP-switch pins 3, 5, 6, 7, 8, 9, and 11 to OFF.
- 3 Select options with DIP-switch pins 1, 4, and 12.

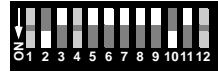

To set a slave

- 1 Set DIP-switch 10 to ON.
- 2 Set pins 1, 2, 3, 4, 5 and 11 to OFF.
- 3 Select options with DIP-switch pins 6, 7, 8, 9, and 12.

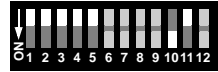

STAND-ALONE SETTINGS

DIP-switch pins 1-9 enable stand-alone options only when pin 10 is ON. When pin 10 is off, the DIP-switch selects a DMX address. *Pin 11 must be OFF for stand-alone operation.*

Pin 12 selects lamp power and works in all modes. Set it to ON for reduced lamp voltage and longer lamp life; set it to OFF for full intensity.

The DIP-switch 10 setting takes effect only after the fixture has been turned off and on.

Fixture	Option	Setting (0 = OFF, 1 = ON)										
		1	2	3	4	5	6	7	8	9	10	11
single or master	auto trigger	0	1	0					0			
	music trigger	1	1	0					0			
	slow change		1	0	1				0			
slave	random color			0			1				1	0
	random gobo			0				1				
	inverted color			0					1			
	inverted gobo			0						1		

MC-1 OPERATION

CX-2s with CPU firmware v 1.2 or higher are fully compatible with the Martin MC-1 Controller. See the MC-1 user manual for additional information.

MC-1 SETTINGS

DIP-switch pin 10 must be set to OFF to enable MC-1 mode operation. Changes to the setting take effect after the fixture has been turned off and on.

DIP-switch pins 6, 7, 8, and 9 select several control options that can be combined to achieve powerful effects quickly and easily.

Pin 12 selects lamp power and works in all modes. Set it to ON for reduced lamp voltage and longer lamp life; set it to OFF for full intensity.

Option	Setting (0 = OFF, 1 = ON)										
	1	2	3	4	5	6	7	8	9	10	11
random color						1				0	
random gobo							1			0	
inverted color								1		0	
inverted gobo									1	0	

DMX OPERATION

This section describes how to select the DMX operation mode and address using the DIP-switch and briefly describes the programmable control options.

DMX MODES

The CX-2 has 2 DMX modes to choose from: a 1-channel mode that provides control of the built-in stand-alone features, and a 4-channel mode that provides full control of all effects.

To select DMX mode

- 1 **Disconnect the fixture from power. Set DIP-switch pin 10 to OFF.**
- 2 **To select 1-channel DMX mode, set DIP-switch pin 11 to ON.**
- 3 **To select 4-channel DMX mode, set DIP-switch pin 11 to OFF.**

DMX ADDRESS

DIP-switch pins 1-9 are used to set the control address. The address, also known as the start channel, is the first channel used to receive instructions from the controller.

For independent control, each fixture must be assigned its own address and non-overlapping control channels. Two CX-2s may share the same address only if they are to respond identically: they will receive the same instructions and individual control will not be possible.

To set the DMX address

- 1 **Select an address for the fixture on your controller. Look up the DIP-switch setting for the address in the table below.**
- 2 **Disconnect the fixture from power.**
- 3 **Set pins 1 through 9 to the ON (1) or OFF (0) position as listed in the table.**

Find the address in the table. Read the settings for pins 1 - 5 to the left and read the settings for pins 6 - 9 above the address. "0" means OFF and "1" means ON. Pin 10 is always OFF for DMX operation.

DIP-Switch Setting					#9	0	0	0	0	0	0	0	0	1	1	1	1	1	1	1	1	
0 = OFF					#8	0	0	0	0	1	1	1	1	0	0	0	0	0	1	1	1	1
1 = ON					#7	0	0	1	1	0	0	1	1	0	0	1	1	0	0	1	1	
					#6	0	1	0	1	0	1	0	1	0	1	0	1	0	1	0	1	
#1	#2	#3	#4	#5																		
0	0	0	0	0		32	64	96	128	160	192	224	256	288	320	352	384	416	448	480		
1	0	0	0	0	1	33	65	97	129	161	193	225	257	289	321	353	385	417	449	481		
0	1	0	0	0	2	34	66	98	130	162	194	226	258	290	322	354	386	418	450	482		
1	1	0	0	0	3	35	67	99	131	163	195	227	259	291	323	355	387	419	451	483		
0	0	1	0	0	4	36	68	100	132	164	196	228	260	292	324	356	388	420	452	484		
1	0	1	0	0	5	37	69	101	133	165	197	229	261	293	325	357	389	421	453	485		
0	1	1	0	0	6	38	70	102	134	166	198	230	262	294	326	358	390	422	454	486		
1	1	1	0	0	7	39	71	103	135	167	199	231	263	295	327	359	391	423	455	487		
0	0	0	1	0	8	40	72	104	136	168	200	232	264	296	328	360	392	424	456	488		
1	0	0	1	0	9	41	73	105	137	169	201	233	265	297	329	361	393	425	457	489		
0	1	0	1	0	10	42	74	106	138	170	202	234	266	298	330	362	394	426	458	490		
1	1	0	1	0	11	43	75	107	139	171	203	235	267	299	331	363	395	427	459	491		
0	0	1	1	0	12	44	76	108	140	172	204	236	268	300	332	364	396	428	460	492		
1	0	1	1	0	13	45	77	109	141	173	205	237	269	301	333	365	397	429	461	493		
0	1	1	1	0	14	46	78	110	142	174	206	238	270	302	334	366	398	430	462	494		
1	1	1	1	0	15	47	79	111	143	175	207	239	271	303	335	367	399	431	463	495		
0	0	0	0	1	16	48	80	112	144	176	208	240	272	304	336	368	400	432	464	496		
1	0	0	0	1	17	49	81	113	145	177	209	241	273	305	337	369	401	433	465	497		
0	1	0	0	1	18	50	82	114	146	178	210	242	274	306	338	370	402	434	466	498		
1	1	0	0	1	19	51	83	115	147	179	211	243	275	307	339	371	403	435	467	499		
0	0	1	0	1	20	52	84	116	148	180	212	244	276	308	340	372	404	436	468	500		
1	0	1	0	1	21	53	85	117	149	181	213	245	277	309	341	373	405	437	469	501		
0	1	1	0	1	22	54	86	118	150	182	214	246	278	310	342	374	406	438	470	502		
1	1	1	0	1	23	55	87	119	151	183	215	247	279	311	343	375	407	439	471	503		
0	0	0	1	1	24	56	88	120	152	184	216	248	280	312	344	376	408	440	472	504		
1	0	0	1	1	25	57	89	121	153	185	217	249	281	313	345	377	409	441	473	505		
0	1	0	1	1	26	58	90	122	154	186	218	250	282	314	346	378	410	442	474	506		
1	1	0	1	1	27	59	91	123	155	187	219	251	283	315	347	379	411	443	475	507		
0	0	1	1	1	28	60	92	124	156	188	220	252	284	316	348	380	412	444	476	508		
1	0	1	1	1	29	61	93	125	157	189	221	253	285	317	349	381	413	445	477	509		
0	1	1	1	1	30	62	94	126	158	190	222	254	286	318	350	382	414	446	478	510		
1	1	1	1	1	31	63	95	127	159	191	223	255	287	319	351	383	415	447	479	511		

1-CHANNEL DMX OPERATION

The functions shown in the following table are available in 1-channel mode. When a “stand-alone” function is selected, the fixture steps through a routine using a built-in microphone to trigger the action to the beat of the music. Note that multiple fixtures cannot be synchronized in this mode.

DMX value	Percent	Function
0 - 10	0 - 4	Blackout (light off)
11 - 20	5 - 7	Open (light on)
21 - 80	8 - 31	Strobe
81 - 115	32 - 45	Stand-alone with slow music trigger
116 - 140	46 - 55	Stand-alone with medium music trigger
141 - 175	56 - 68	Stand-alone with fast music trigger
176 - 210	69 - 82	Stand-alone with random music trigger
211 - 255	83 - 100	Manual trigger area, crossover at 240 (94%)

FULL DMX OPERATION

See also the DMX protocol on page 20.

Channel 1 controls the light intensity and the strobe rate. It also allows you to execute a “stand-alone” program with random color and gobo change using automatic or music trigger.

All effect wheels are reset to their home position when the fixture is powered up; they can also be reset from the controller by sending a reset command on channel 1.

Channel 2 controls the position of the color wheel. When set to 100 percent, the wheel moves to random positions using the trigger selected on channel 1.

Channel 3 controls the position of the gobo wheel. When set to 100 percent, the wheel moves to random positions using the trigger selected on channel 1.

Channel 4 controls the speed of effect wheel rotation, allowing you to vary the speed on controllers without cross-faders. If your controller has cross-faders, and you use them, then set channel 4 to the “tracking” speed (0 percent).

BASIC SERVICE

The CX-2 requires simple routine maintenance. The maintenance schedule depends heavily on the operating environment; please consult a Martin service technician for recommendations.

Any service procedure not described here should be referred to a qualified technician.

Important! *Excessive dust, grease, and smoke fluid buildup degrades performance and causes overheating and damage to the fixture that is not covered by the warranty.*

Warning! *Disconnect the fixture from AC power before removing any cover.*

CLEANING

To clean optical components

Use care when cleaning optical components. The surface of the color filters is fragile and small scratches may be visible.

- 1 **Disconnect the fixture from AC power and allow the components to cool completely.**
- 2 **Release the 4 cover locks by turning them a quarter-turn counterclockwise. Lift the cover straight off.**
- 3 **Blow or vacuum away loose dust. Remove residues from lenses and filters with a soft cloth or cotton swabs wetted with isopropyl alcohol. Regular glass cleaner may also be used, but no residues may remain.**
- 4 **Rinse with distilled water. Mixing the water with a small amount of wetting agent such as Kodak Photoflo will help prevent streaking and spotting.**
- 5 **Dry with a clean, soft and lint-free cloth or blow dry with compressed air.**
- 6 **Replace the top cover. To lock the 4 cover locks, turn them a quarter to a half turn clockwise, until you feel them click. *Do not overtighten.***

To clean the fan and air vents

To maintain adequate cooling, dust must be cleaned from the fan and air vents periodically.

- 1 Remove the data and power cables and stand the fixture on end.
- 2 Remove dust and dirt from the fan blades and vent grills using a soft brush, cotton swab, vacuum, or compressed air.

REPLACING FUSES

The CX-2 has 2 fuses. The main fuse holder is built in to the mains input socket. The secondary fuse is located on the printed circuit board.

Warning! *Never replace fuses with ones of a different rating!*

To replace the main fuse

- 1 Unplug the mains cable from the input socket. Pry open the fuse holder and remove the fuse.
- 2 Replace the fuse with one of the same type. The fuse rating is listed on serial number label.

To replace the secondary fuse

- 1 Disconnect the fixture from AC power. Release the 4 cover locks by turning them a quarter-turn counterclockwise. Lift the cover straight off.
- 2 The fuse is located right behind the data input connector. Pry out the defective fuse and replace it with one of the same rating.
- 3 Replace the cover before applying power.

TROUBLESHOOTING

10

Problem	Probable cause(s)	Remedy
One or more of the fixtures is completely dead.	No power to fixture.	Check that power is switched on and cables are plugged in.
	Primary fuse blown.	Replace fuse.
	Secondary fuse blown.	Replace fuse.
Fixtures reset correctly but all respond erratically or not at all to the controller.	The controller is not connected.	Connect controller.
	XLR pin-out of the controller does not match pin-out of the first fixture on the link (i.e. signal is reversed).	Install a phase-reversing cable between the controller and the first fixture on the link.
Fixtures reset correctly but some respond erratically or not at all to the controller.	Bad data link connection	Inspect connections and cables. Correct poor connections. Repair or replace damaged cables.
	Data link not terminated with 120Ω termination plug.	Insert termination plug in output jack of the last fixture on the link.
	Incorrect addressing of the fixtures.	Check DIP-switch settings.
	One of the fixtures is transmitting as a master or is defective.	Bypass one fixture at a time until normal operation is regained: unplug both connectors and connect them directly together. Have the defective fixture serviced by a qualified technician.
An effect fails to reset correctly.	The effect requires mechanical adjustment.	Contact Martin technician for service.
No light.	Lamp missing or blown	Disconnect fixture and replace lamp.
Lamp cuts out intermittently or burns out too quickly.	Fixture is too hot.	Allow fixture to cool.
	The transformer setting does not match local AC voltage.	Check AC setting.

DMX PROTOCOL



Channel	Value	Percent	Function
1	0 - 4	0 - 1	Dimmer, Strobe, Reset
	5 - 154	2 - 60	Light off
	155 - 169	61 - 66	Dimmer, closed to open
	170 - 229	67 - 89	Dimmer full open
	230 - 239	90 - 93	Strobe, fast to slow
	240 - 249	94 - 97	Stand-alone, music trigger
	250 - 255	98 - 100	Stand-alone, auto trigger
			Reset
2	0 - 5	0 - 1	Color Wheel
	6 - 11	2 - 4	Open
	12 - 17	4 - 6	Open / Light blue 101
	18 - 23	7 - 9	Light blue 101
	24 - 29	9 - 11	Light blue 101/ Fern green 205
	30 - 35	11 - 13	Fern green 205
	36 - 41	14 - 16	Fern green 205 / Red 304
	42 - 47	16 - 18	Red 304
	48 - 53	18 - 20	Red 304 / Yellow 603
	54 - 59	21 - 23	Yellow 603
	60 - 65	23 - 25	Yellow 603 / Magenta 507
	66 - 71	26 - 27	Magenta 507
	72 - 77	28 - 30	Magenta 507 / Medium blue 108
	78 - 83	30 - 32	Medium blue 108
	84 - 89	33 - 35	Medium blue 108 / Deep orange 302
	90 - 95	35 - 37	Deep orange 302
	96 - 101	37 - 39	Deep orange 302 / Light green 204
	102 - 107	40 - 42	Light green 204
	108 - 113	42 - 44	Light green 204 / Cyan 104
	114 - 119	44 - 46	Cyan 104
	120 - 125	47 - 49	Cyan 104 / Pink 312
	126 - 131	49 - 51	Pink 312
	132 - 137	52 - 53	Pink 312 / Blue 111
	138 - 143	54 - 56	Blue 111
	144 - 149	56 - 58	Blue 111 / Amber 604
	150 - 155	59 - 61	Amber 604
	156 - 161	61 - 63	Amber 604 / Primary red 308
	162 - 167	63 - 65	Primary red 308
	168 - 173	66 - 68	Primary red 308 / Primary green 206
	174 - 179	68 - 70	Primary green 206
	180 - 185	70 - 72	Primary green 206 / Orange 306
	186 - 191	73 - 75	Orange 306
192 - 197	75 - 77	Orange 306 / Split-color 1	
198 - 203	78 - 79	Split-color 1	
204 - 209	80 - 82	Split-color 1 / Split-color 2	
210 - 255	82 - 100	Split-color 2	
		Random "stand-alone" position w/ music or auto trigger	

Channel	Value	Percent	Function
3	0 - 11	0 - 4	Gobo Wheel Open
	12 - 23	5 - 8	Frost
	24 - 35	9 - 13	Virus
	36 - 47	14 - 18	Dot circle
	48 - 59	19 - 23	Spokes
	60 - 71	24 - 27	Atomic
	72 - 83	28 - 32	Dot cross
	84 - 95	33 - 37	Dot cone
	96 - 107	38 - 41	Holes 3
	108 - 119	42 - 46	Clouds 2
	120 - 131	47 - 51	Highways
	132 - 143	52 - 55	Worms 3
	144 - 155	56 - 60	XL iris
	156 - 167	61 - 65	L iris
	168 - 179	66 - 70	M iris
	180 - 191	71 - 74	S iris
	192 - 203	75 - 79	XS iris
204 - 215	80 - 84	Closed	
216 - 255	85 - 100	Random "stand-alone" position w/ music or auto trigger	
4	0 - 2	0 - 1	Color / Gobo Speed Tracking (speed function off)
	3 - 255	2 - 100	Fast to slow

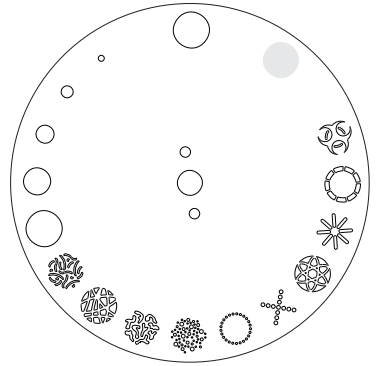

SPECIFICATIONS

B

PHYSICAL

Size (L x W x H): 296 x 269 x 270 mm (11.7 x 10.6 x 12.1 in)
Weight: 5.5 kg (12.1 lbs)

THERMAL

Maximum ambient temperature (Ta): 40° C (104° F)
Maximum surface temperature: 65° C (149° F)

CONTROL AND PROGRAMMING

DMX-512 (1990) control: 1 / 4 channel, tracking and vector
Stand-alone control: automatic & music trigger, master/slave configurable
Data pinout: 3-pin XLR - pin 1 shield, pin 2 cold (-), pin 3 hot (+)

AC SUPPLY

AC input: 3-pin IEC male socket
Wiring options, "EU" model: 230/245 V, 50-60 Hz
Wiring options, "US" model: 110/120 V, 50-60 Hz
Maximum power and current: 250 W, 1.1 A @ 230 V

FUSES

Primary fuse, EU model: 2.5 AT / 250 V, P/N 05020010
Primary fuse, US model: 5.0 AT / 250 V, P/N 05020018
Secondary fuse: 2.0 AT / 250 V, P/N 05020009

CONSTRUCTION

Housing: UV-resistant fiber-reinforced composite
Finish: black, integral color

INSTALLATION

Minimum distance to combustible materials: 0.1 m (4 in)
Minimum distance to illuminated surfaces: 0.3 m (12 in)
Minimum clearance around fan and air vents: 0.1 m (4 in)

ACCESSORIES

MC-1 Controller, EU: 90718000
MC-1 Controller, US: 90718100
OSRAM 50 h ELC halogen lamp: 97000104
Philips 300 h ELC halogen lamp: 97000106
G-clamp: 91602003
Half-coupler clamp: 91602005

CX-2 4-Channel DMX Protocol

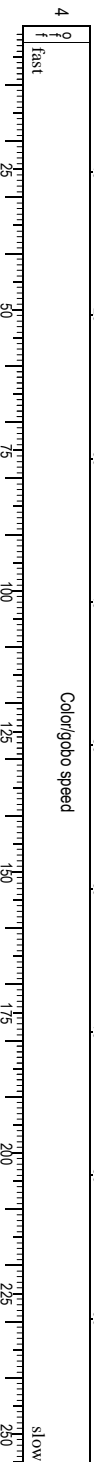
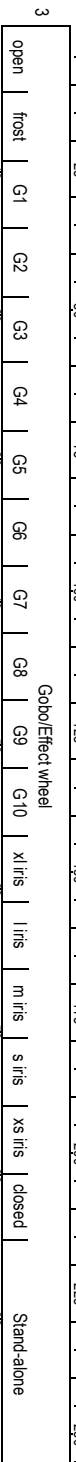
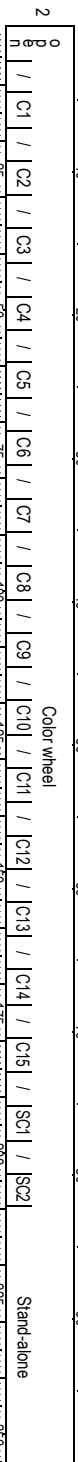
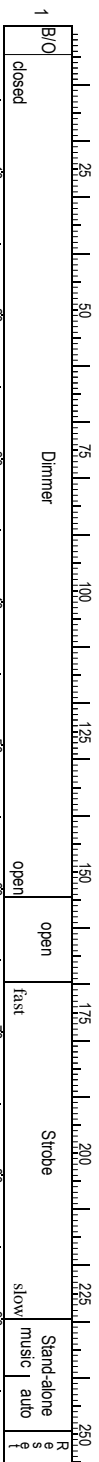

CX-2 1-Channel DMX Protocol

