



Panasonic

Integrated Telephone System

Model No. **KX-TS2305HGW**

Pulse-or-tone dialing capability

Operating Instructions



Preparation

Basic Operation

Advanced Operation

Useful Information

PLEASE READ BEFORE USE AND SAVE.

Before Initial Use

Thank you for purchasing your new Panasonic integrated telephone.

For your future reference

Serial No. _____
(found on the bottom of the unit)

Date of purchase _____

Name and address of dealer _____

Accessories (included)

Handset one
(p. 5)

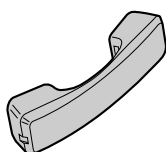

Handset Cord one
(p. 5)

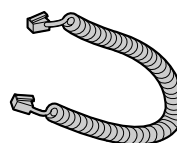

Telephone Line Cord one
(p. 5)

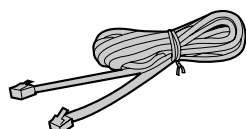

Wall Mounting Adaptor one
(p. 9)

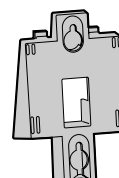

Contents

Preparation	
Location of Controls	4
Settings	5
Installing the Batteries	5
Connecting the Handset/Telephone Line Cord	5
Connecting a Communication Device	6
Programming Summary of Preparations	7
Selecting the Dialing Mode	8
Selecting the Ringer Volume	8
Wall Mounting	9
Basic Operation	
Making Calls	10
Answering Calls	11
Advanced Operation	
Speed Dialer	12
Storing Phone Numbers in Memory	12
Dialing a Stored Number	13
One-Touch Dialer	14
Storing Phone Numbers in Memory	14
Dialing a Stored Number	16
Special Features	17
For Call Waiting Service Users	17
Temporary Tone Dialing (For Rotary or Pulse Service Users)	17
How to Use the PAUSE Button (For Analog PBX Line/Long Distance Service Users)	17
Muting Your Conversation	18
Turning Music Played During the Hold ON/OFF	18
FLASH Button	19
Setting the PIN Code	20
Dial Lock	21
Call Restriction	22
Useful Information	
Using the Optional Headset	23
Battery Replacement	25
Before Requesting Help	26
Safety Instructions	27

Preparation

Basic Operation

Advanced Operation

Useful Information

Location of Controls

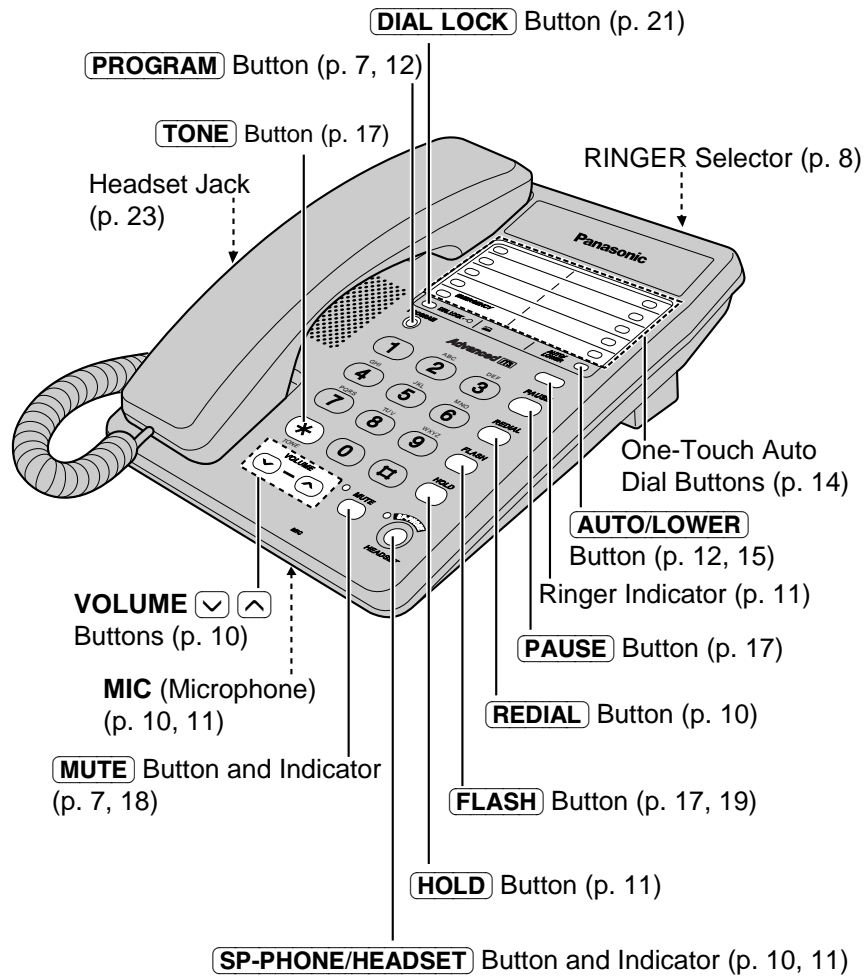

Settings



Installing the Batteries

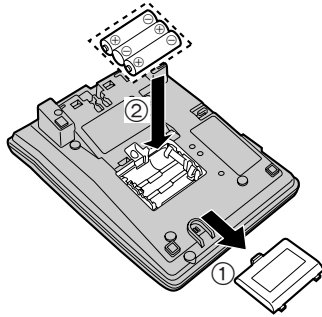

1. Press down in the direction of the arrow and remove the cover.
2. Install the batteries in the proper order as shown, matching the correct polarity.
3. Close the battery cover.

Preparation

- Batteries are not included in the unit.
- Install three high quality "AA" Alkaline or Manganese batteries. We recommend to use Alkaline batteries.
Battery life is: —about six months in use of Alkaline batteries.
—about three months in use of Manganese batteries.
- Make sure to install the batteries for the following features to operate properly:
 - Buttons' function when the handset is on the cradle
 - Speakerphone (p. 10, 11)
 - Programming (p. 7)

Connecting the Handset/Telephone Line Cord

After connection, lift the handset to check for a dial tone.

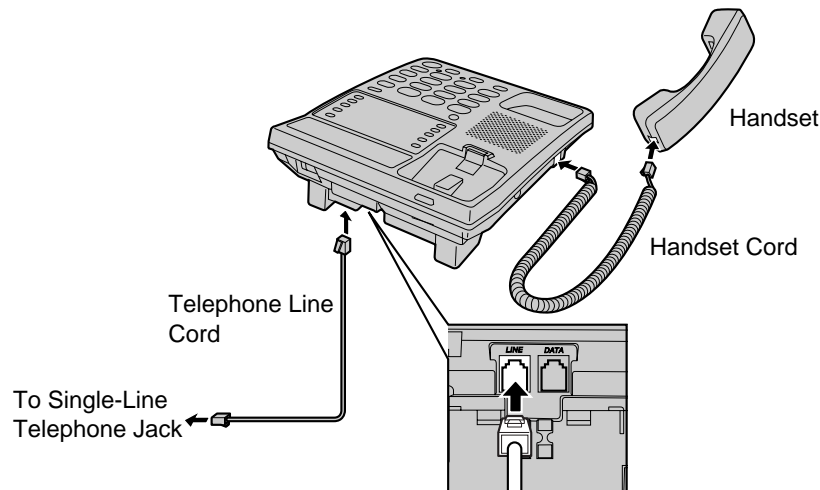

- Use only a Panasonic Handset for the KX-TS2305HGW.

► Settings

Connecting a Communication Device

If you connect a communication device (computer, modem, fax, answering machine, etc.) to the telephone line, you can connect it through this unit using the DATA jack.

After connecting the handset and telephone line cord (p. 5), connect the communication device telephone line cord to the DATA jack.

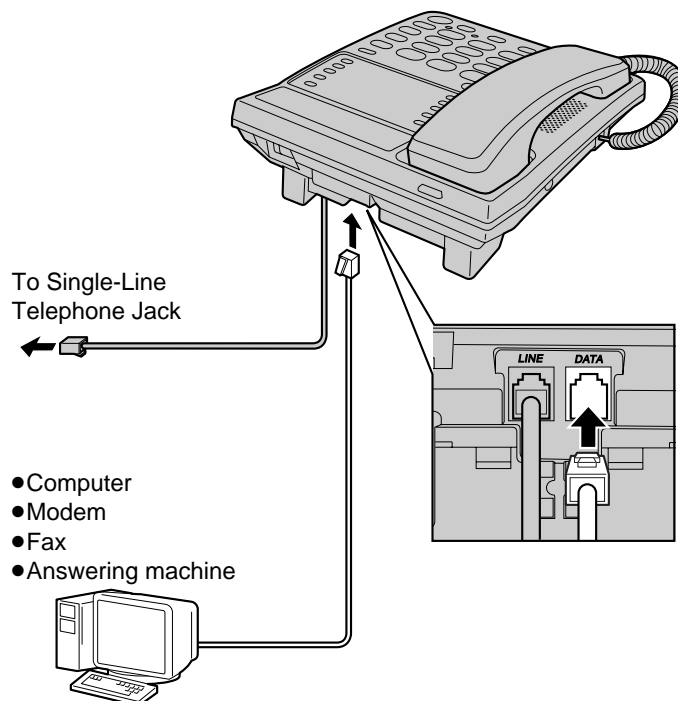

- Make sure the communication device is not in use before using this unit (making calls, storing phone numbers in memory etc.) or the communication device may not operate properly.



Programming Summary of Preparations

You can program the following functions. See the corresponding pages for function details.

Make sure that a call is not put on hold.

Press **PROGRAM**.



Press **MUTE**.



- **To set the call restriction, press 1.** (page 22)
- **To change the flash time, press 2.** (page 19)
- **To select the dialing mode, press 3.** (page 8)
- **To turn on/off music played during the hold, press 4.** (page 18)
- **To change the PIN code for the dial lock and call restriction, press 5.** (page 20)



Press **PROGRAM** to store the setting.

- You can exit the programming mode any time by pressing **PROGRAM**.
- If you do not press any buttons for 60 seconds, the unit will return to the standby mode.

► Settings

Selecting the Dialing Mode

You can select the dialing mode by programming. If you have touch tone service, set to "Tone". If rotary or pulse service is used, set to "Pulse". Your phone comes from the factory set to "Tone".

Make sure that a call is not put on hold.

- 1 Press **PROGRAM**.
 - The MUTE indicator flashes.
- 2 Press **MUTE**.
- 3 Press **3**.
- 4 To select "Pulse", press **2**.
or
To select "Tone", press **1**.
- 5 Press **PROGRAM**.
 - A long beep sounds.
 - The MUTE indicator light goes out.
 - The unit will return to the standby mode.

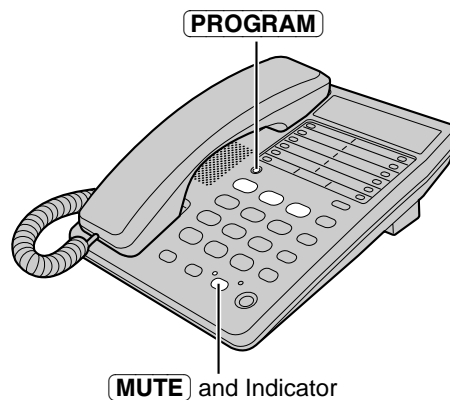

Selecting the Ringer Volume

You can select the ringer volume to HIGH, LOW or OFF. Your phone comes from the factory set to HIGH.

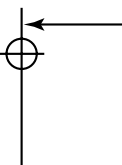
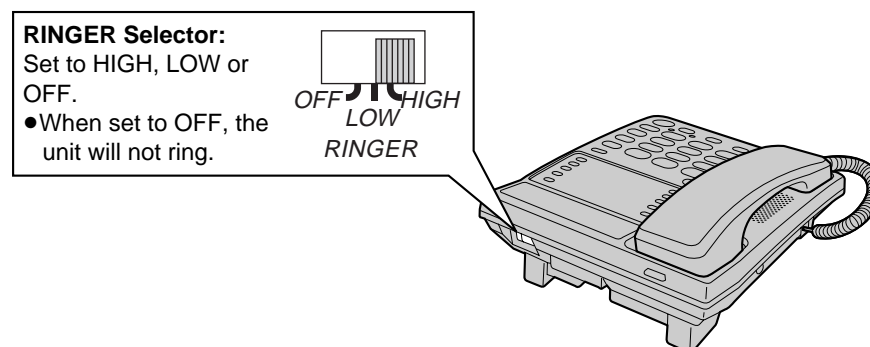

Wall Mounting

This unit can be mounted on a wall.

- 1 Pull down the handset hook until it locks, so the tab holds the handset.

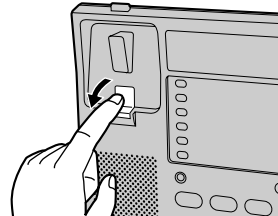

- 2 Tuck the telephone line cord inside the wall mounting adaptor, and push it in the direction of the arrow.
 - “UP” should be facing upward.

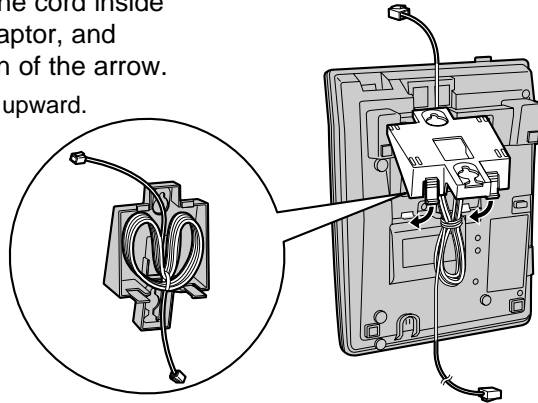

- 3 Install screws using the wall template below. Connect the telephone line cord. Mount the unit, and slide down.

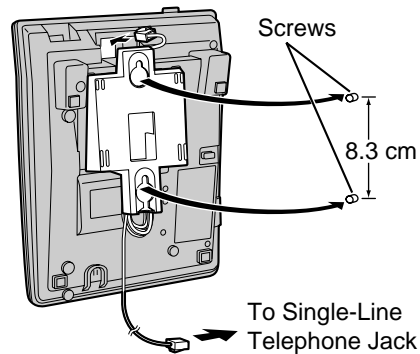
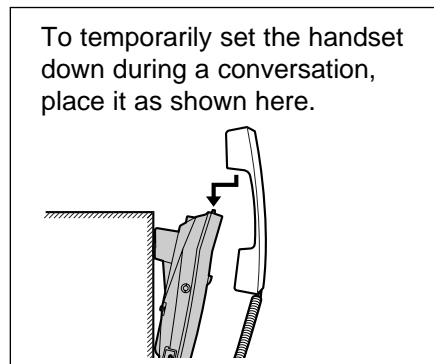

Wall Template

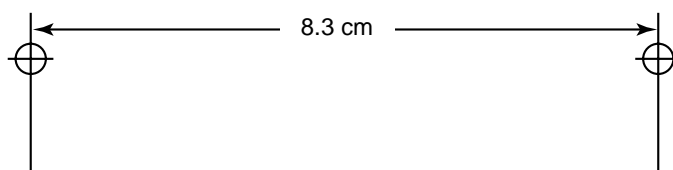

Making Calls

You can make a call by simply lifting the handset. To hang up, place the handset on the cradle.

Using the speakerphone

- 1 Press **SP-PHONE/HEADSET**.
 - The indicator lights.
- 2 Dial a phone number.
 - If you misdial, press **SP-PHONE/HEADSET** and start again from step 1.
- 3 When the other party answers, talk into the **MIC** (microphone).
- 4 To hang up, press **SP-PHONE/HEADSET**.
 - The indicator light goes out.

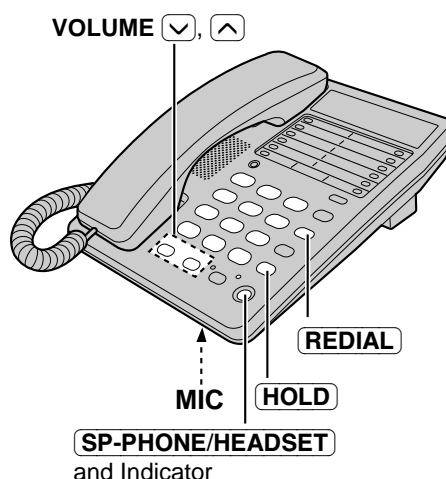

To redial the last number dialed

Using the handset: Lift the handset → press **REDIAL**.

Using the speakerphone: Press **SP-PHONE/HEADSET** → press **REDIAL**.

Automatic Redial:

When using the speakerphone, the unit redials the last dialed number up to 15 times within a 10-minute period if the line is busy. During redial, the SP PHONE/HEADSET indicator light flashes.

To adjust the handset volume (4 levels) or the speaker volume (8 levels) while talking

To increase, press **VOLUME**

To decrease, press **VOLUME**

To put a call on hold

Press **HOLD**.

- The SP-PHONE/HEADSET indicator light flashes.
- If using the handset, you can place it on the cradle.
- During the hold, the caller will hear music. For canceling music, see page 18.

To release the hold

If the handset is on the cradle, lift the handset.

If the handset is off the cradle, press **HOLD**.

If using the speakerphone, press **SP-PHONE/HEADSET**.

- If another phone is connected on the same line, you can also release the hold by lifting its handset.

During speakerphone operation

For best performance, please note the following:

- Talk alternately with the other party in a quiet room.
- If the other party has difficulty hearing you, press **VOLUME** to decrease the speaker volume.
- You can switch to the handset by lifting it up. To switch back to the speakerphone, press **SP-PHONE/HEADSET**.

- When you dial a phone number in using pulse line or lift the handset off the cradle, the Ringer indicator also flashes. This is normal.

Answering Calls

While a call is being received, the unit rings and the ringer indicator flashes. You can answer it by simply lifting the handset.

Using the speakerphone

- 1 Press **SP-PHONE/HEADSET**.
 - The indicator lights.
- 2 Talk into the **MIC** (microphone).
- 3 To hang up, press **SP-PHONE/HEADSET**.
 - The indicator light goes out.

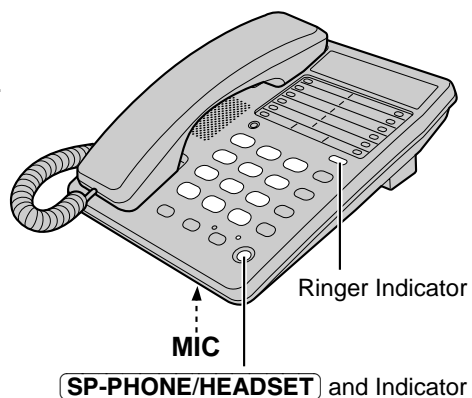

- When the ringer volume is set to OFF (p. 8), the unit will not ring.

Speed Dialer

Storing Phone Numbers in Memory

You can store up to 10 phone numbers in memory. The dialing buttons (0 to 9) function as memory stations. Do not press any memory stations before storing to prevent misoperation.

Make sure that a call is not put on hold.

- 1 Press **PROGRAM**.
 - The MUTE indicator flashes.
- 2 Enter a phone number, up to 22 digits.
 - If you enter a wrong number, press **PROGRAM** and start again from step 1.
- 3 Press **AUTO/LOWER**.
- 4 Press a memory station number (0 to 9).
 - A long beep sounds.
 - The MUTE indicator light goes out.
 - The unit will return to the standby mode.
 - If 3 beeps sound, the number entered in step 2 may be over 22 digits. Lift the handset and place it on the cradle to return to the standby mode, and start again from step 1.

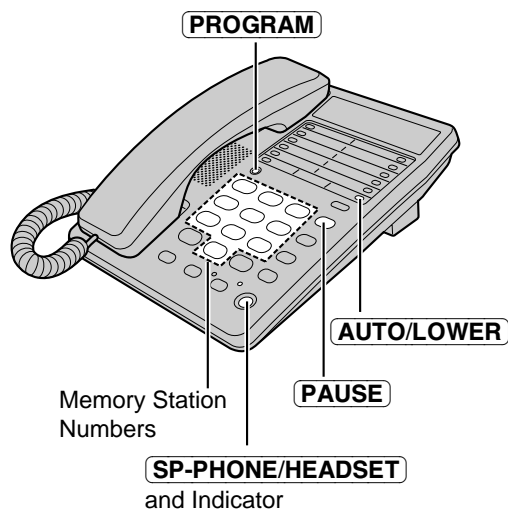

- You can exit the programming mode in step 1 and 2 by pressing **PROGRAM**.
- If a pause is required for dialing, press **PAUSE** where needed. Pressing **PAUSE** counts as one digit (p. 17).

To erase a stored number

- 1 Press **PROGRAM**.
 - The MUTE indicator flashes.
- 2 Press **AUTO/LOWER**.
- 3 Press a memory station number (**0** to **9**) for the phone number to be erased.
 - A long beep sounds.
 - The MUTE indicator light goes out.
 - The unit will return to the standby mode.

Dialing a Stored Number

- 1 Lift the handset or press **SP-PHONE/HEADSET**.
- 2 Press **AUTO/LOWER**.
- 3 Press the memory station number (**0** to **9**).
 - The stored number is dialed.

One-Touch Dialer

Storing Phone Numbers in Memory

You can store up to 20 phone numbers in the one-touch auto dial buttons (10 numbers in UPPER memory locations, 10 numbers in LOWER memory locations).

Do not press any one-touch auto dial buttons before storing to prevent misoperation.

Make sure that a call is not put on hold.

To store in an UPPER memory location

It is recommended that you program an emergency number in the EMERGENCY button.

- 1 Press **PROGRAM**.
 - The MUTE indicator flashes.
- 2 Enter a phone number, up to 22 digits.
 - If you enter a wrong number, press **PROGRAM** and start again from step 1.
- 3 Press one of the one-touch auto dial buttons.
 - A long beep sounds.
 - The MUTE indicator light goes out.
 - The unit will return to the standby mode.
 - If 3 beeps sound, the number entered in step 2 may be over 22 digits. Press **PROGRAM** to return to the standby mode and start again from step 1.

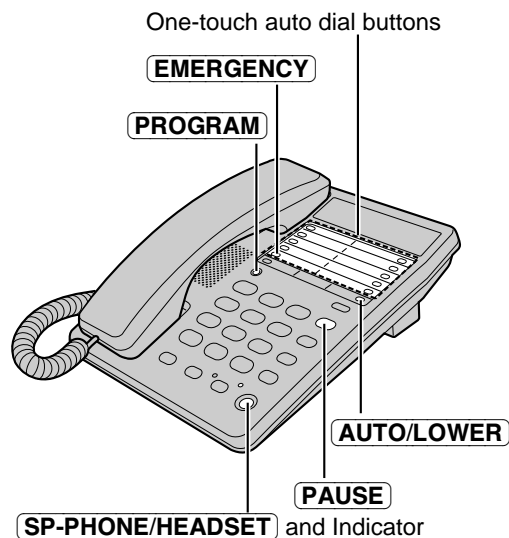

- If a pause is required for dialing, press **PAUSE** where needed. Pressing **PAUSE** counts as one digit (p. 17).



To store in a LOWER memory location

- 1 Press **PROGRAM**.
 - The MUTE indicator flashes.
 - 2 Enter a phone number, up to 22 digits.
 - If you enter a wrong number, press **PROGRAM** and start again from step 1.
 - 3 Press **AUTO/LOWER**.
 - 4 Press one of the one-touch auto dial buttons.
 - A long beep sounds.
 - The MUTE indicator light goes out.
 - The unit will return to the standby mode.
 - If 3 beeps sound, the number entered in step 2 may be over 22 digits. Lift the handset and place it on the cradle to return to the standby mode, and start again from step 1.
- If a pause is required for dialing, press **PAUSE** where needed. Pressing **PAUSE** counts as one digit (p. 17).

To erase a stored number

- 1 Press **PROGRAM**.
 - The MUTE indicator flashes.
- 2 If the phone number is in an UPPER memory location, press the one-touch auto dial button for the phone number to be erased.
OR
If the phone number is in a LOWER memory location, press **AUTO/LOWER**, then press the one-touch auto dial button for the phone number to be erased.
 - A long beep sounds.
 - The MUTE indicator light goes out.
 - The unit will return to the standby mode.

► One-Touch Dialer

Dialing a Stored Number

From an UPPER memory location:

- 1 Lift the handset or press **SP-PHONE/HEADSET**.
- 2 Press the required one-touch auto dial button.
 - The stored number is dialed.

OR

From a LOWER memory location:

- 1 Lift the handset or press **SP-PHONE/HEADSET**.
- 2 Press **AUTO/LOWER**.
- 3 Press the required one-touch auto dial button.
 - The stored number is dialed.

Memory card

Remove the memory card and use it as a name or phone number index for the stored numbers.

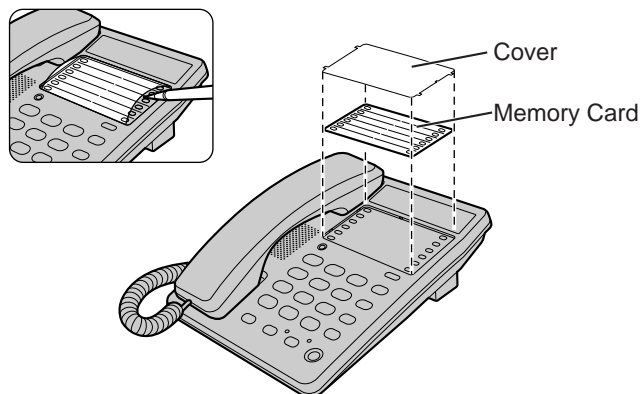

Special Features

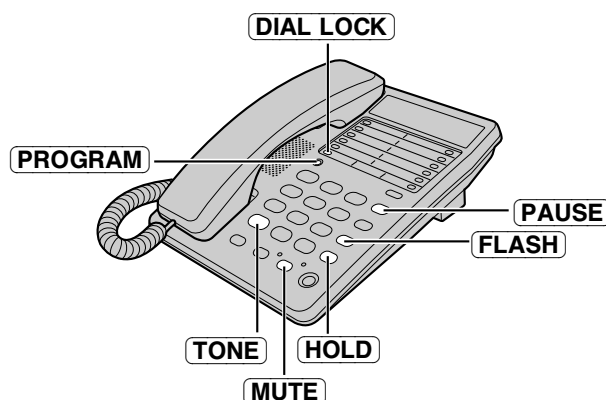

For Call Waiting Service Users

Press **FLASH** if you hear a call-waiting tone while talking.

- The first call is put on hold and you can answer the second call.
- To return to the first caller, press **FLASH** again.
- If this function does not operate properly, consult your telephone company.

Temporary Tone Dialing (For Rotary or Pulse Service Users)

Press **TONE** before entering access numbers which require tone dialing.

- The dialing mode changes to tone. You can enter numbers to access an answering service, electronic banking service, etc. When you hang up, the mode will return to pulse.

How to Use the PAUSE Button (For Analog PBX Line/Long Distance Service Users)

We recommend you press **PAUSE** if a pause is required for dialing with a PBX or to access a long distance service.

Ex. Line access number **9** (PBX)

9 → **PAUSE** → Phone number

- Pressing **PAUSE** once creates a few seconds pause. This prevents misdialing when you redial or dial a stored number.
- Pressing **PAUSE** more than once increases the length of the pause between numbers.

► Special Features

Muting Your Conversation

Press **MUTE** while talking.

- The MUTE indicator lights.
- The other party cannot hear you but you can hear them.
- To resume the conversation, press **MUTE** again.

Turning Music Played During the Hold ON/OFF

You can turn ON/OFF playing music during the hold as follows.
Your phone comes from the factory set to ON.

Make sure that a call is not put on hold.

- 1 Press **PROGRAM**.
 - The MUTE indicator flashes.
- 2 Press **MUTE**.
- 3 Press **4**.
- 4 To turn OFF, press **2**.
OR
To turn ON, press **1**.
- 5 Press **PROGRAM**.
 - A long beep sounds.
 - The MUTE indicator light goes out.
 - The unit will return to the standby mode.

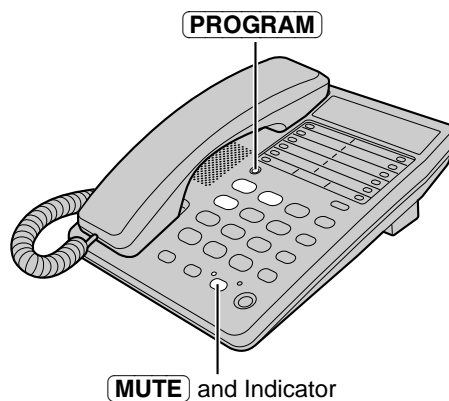



FLASH Button

Pressing **FLASH** allows you to use special features of your host PBX such as transferring an extension call or accessing special telephone services (optional) such as call waiting.

Selecting the flash time

The flash time depends on your telephone exchange or host PBX. You can select the following flash times: “80, 90, 100, 110, 200, 250, 300, 400, 600, 700 ms (milliseconds)”. Your phone comes from the factory set to “100 ms”.

Make sure that a call is not put on hold.

1 Press **PROGRAM**.
•The MUTE indicator flashes.

2 Press **MUTE**.

3 Press **2**.

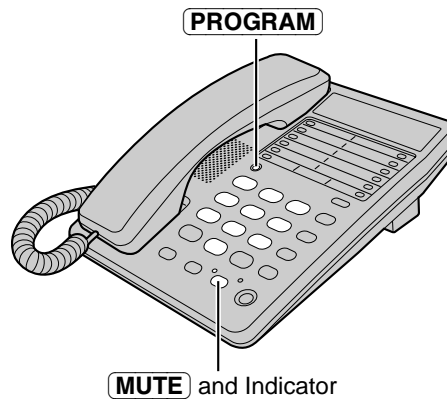

4 Press a dialing button (**1** to **0**).

1 : 80 ms	2 : 90 ms	3 : 100 ms	4 : 110 ms
5 : 200 ms	6 : 250 ms	7 : 300 ms	8 : 400 ms
9 : 600 ms	0 : 700 ms		

5 Press **PROGRAM**.
•A long beep sounds.
•The MUTE indicator light goes out.
•The unit will return to the standby mode.

•If you are connected via a PBX, a longer flash time may be necessary to use PBX functions (transferring a call, etc.). Consult your PBX installer for the correct setting.

► Special Features

Setting the PIN Code

A 4-digit PIN Code (Personal Identification Number) prevents unauthorized persons from using your unit. The PIN Code is required for the dial lock and call restriction to be set or canceled. The factory preset PIN code is "1111".

Make sure that a call is not put on hold.

- 1 Press **PROGRAM**.
 - The MUTE indicator flashes.
- 2 Press **MUTE**.
- 3 Press **5**.
- 4 Enter the current PIN code.
- 5 Press **PROGRAM**.
 - If a correct PIN code is entered, a beep will sound.
 - If a wrong PIN code is entered, 3 beeps will sound. Enter the correct PIN code and press **PROGRAM**.
 - To return to the standby mode, lift the handset and hang up.
- 6 Enter a new PIN code using a 4-digit number.
- 7 Press **PROGRAM**.
 - A long beep sounds.
 - The MUTE indicator light goes out.
 - The unit will return to the standby mode.

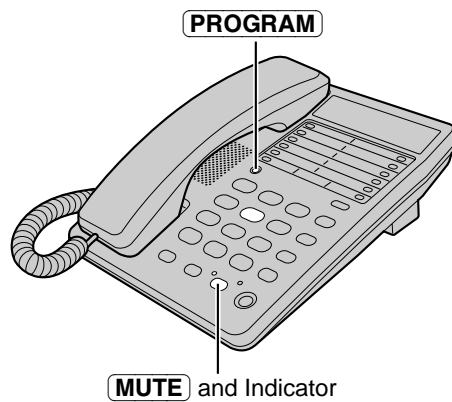

Please write down your PIN code. If you forget your PIN code, consult your nearest Panasonic service center.



Dial Lock

You can prevent others from making a call to any number except the one pre-programmed in the memory of the EMERGENCY button. Once you locked the dialing buttons, even emergency numbers cannot be dialed. Only incoming calls are accepted until the dial lock is canceled.

Before using this feature, we recommend storing an emergency number in the memory of the EMERGENCY button (p. 14). Even if the dialing buttons are locked, the number stored in the button can be dialed.

EMERGENCY

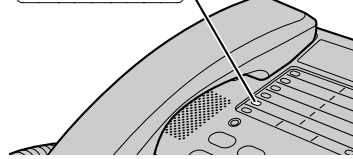

- If you choose not to program emergency numbers, but plan to use the dial lock, any number programmed into the EMERGENCY button can be accessed.

To set the dial lock

- 1 Press **DIAL LOCK**.
 - The MUTE indicator flashes.
- 2 Enter the PIN code (p. 20).
- 3 Press **PROGRAM**.
 - A long beep sounds.
 - If a wrong PIN code is entered, 3 beeps will sound. Enter a correct PIN code and press **PROGRAM**.
 - The MUTE indicator light goes out.
 - The unit will return to the standby mode.

You can use the following features while the dialing buttons are locked.

- Dialing a number you programmed into the memory of the EMERGENCY button (p. 14)
- Adjusting the handset and speakerphone volumes (p. 10)
- Muting the conversation (p. 18)
- Answering the second call by pressing **FLASH** (p. 17)

To cancel the dial lock

Follow steps 1 through 3 above again.

► Special Features

Call Restriction

You can prevent the unit from dialing phone numbers beginning with specified digit(s) (1 digit or 2 digits). Phone numbers with the restricted leading digits cannot be dialed out.

To set the call restriction

Make sure that a call is not put on hold.

- 1 Press **PROGRAM**.
 - The MUTE indicator flashes.
- 2 Press **MUTE**.
- 3 Press **1**.
 - If you use “1111” as a PIN code (factory set), there is no need to enter a PIN code. Go to step 6.
- 4 Enter the PIN code (p. 20).
- 5 Press **PROGRAM**.
 - If a wrong PIN code is entered, 3 beeps will sound. Enter a correct PIN code and press **PROGRAM**.
- 6 Enter the number(s) (1 digit or 2 digits) you want to restrict (**0** to **9**).
 - If you enter a wrong number, enter a correct number.
 - To change restricted digits from 2 digits to 1 digit, press ***** and enter 1 digit.
- 7 Press **PROGRAM**.
 - A long beep sounds.
 - The MUTE indicator light goes out.
 - The unit will return to the standby mode.

- If your unit is connected to a PBX, this function may not operate. Contact your PBX supplier for more information.

To cancel the call restriction

Follow steps 1 through 5. In step 6, press ***** to cancel call restriction and press **PROGRAM**.

- A long beep will sound and the unit will return to the standby mode.

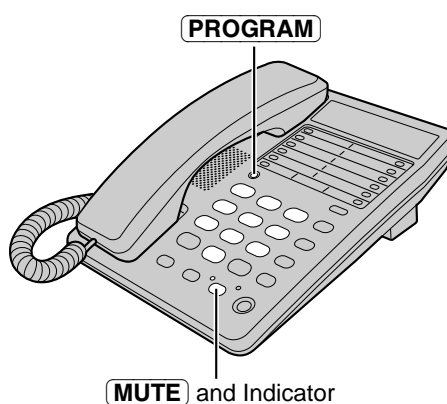

Using the Optional Headset



Plugging the optional headset into the unit allows a hands-free phone conversation. Please use only a Panasonic KX-TCA89EX.

Connecting the Optional Headset to the Unit

Connect the optional headset to the headset jack as shown below.

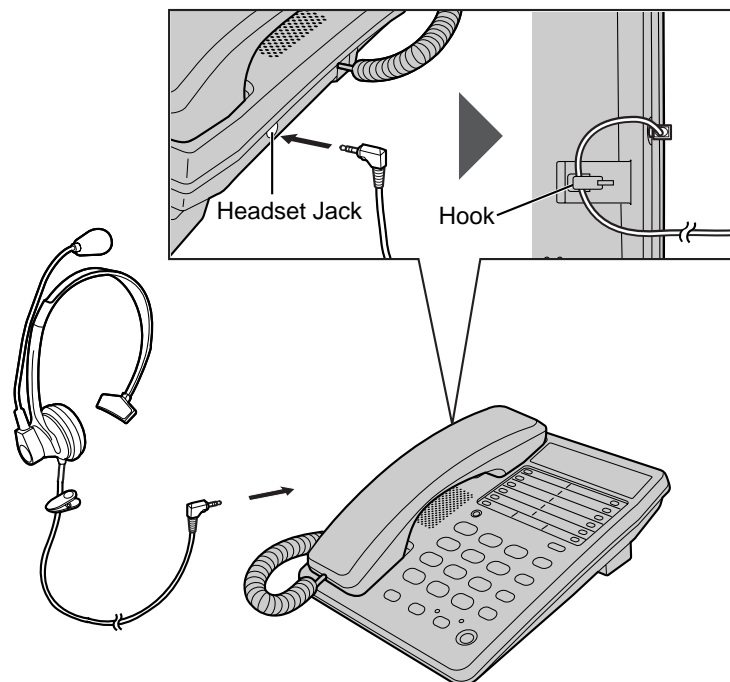

If you want to have a normal conversation, disconnect the headset.

► Using the Optional Headset

Making/Answering Calls

Make sure to install the batteries.

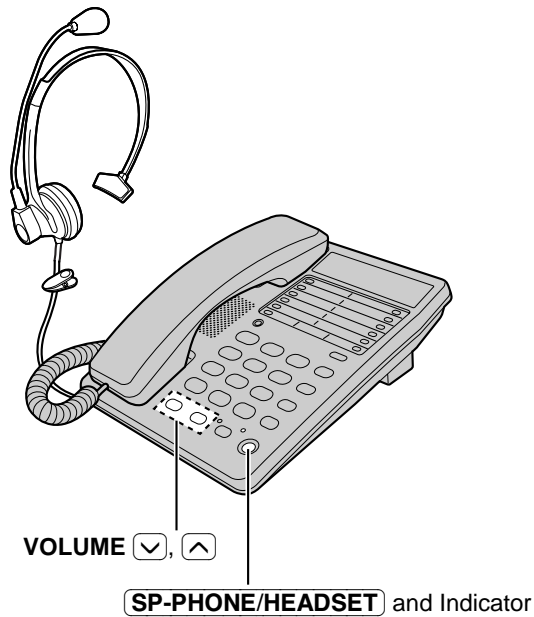

- 1 Press **SP-PHONE/HEADSET** to make or answer a call.
 - The SP-PHONE/HEADSET indicator flashes.
 - If you misdial when making a call, press **SP-PHONE/HEADSET** twice and dial again.
- 2 To hang up, press **SP-PHONE/HEADSET**.
 - The indicator light goes out.

To adjust the headset receiver volume (4 levels):

While using the headset, press **VOLUME** ▾ or ▸.

- During a conversation using the headset, you cannot switch the call to the handset by lifting it off the cradle.
- If you disconnect the optional headset during a conversation with the handset on the cradle, the call will be switched to the speakerphone.
- During a conversation using the speakerphone, you can switch the call to the headset by connecting the headset.

Battery Replacement

If the speakerphone does not work, it may be the time to replace the batteries. Replace the batteries within 1 minute to keep the programmed settings.

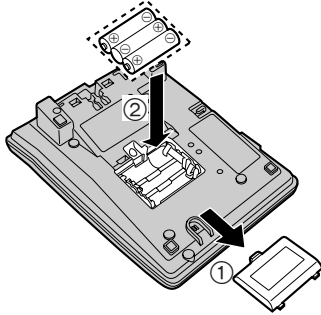

1. Press down in the direction of the arrow and remove the cover.
2. Replace the batteries with new ones using correct polarity (+, -), and close the cover.

● Please replace the batteries while the handset is placed on the cradle.

Battery Precautions:

The batteries should be used correctly, otherwise the unit may be damaged by battery leakage.

- Do not mix different types of batteries.
- Do not charge, short-circuit, disassemble, heat or dispose of in fire.
- Remove all the batteries when replacing.

Note:

- Disconnect the telephone line cord before opening the battery compartment cover.
- Replace all the batteries once a half year in use of Alkaline batteries, or misoperation may occur. (When you use Manganese batteries, replace all of them once in three months.)
- Do not use nickel-cadmium batteries.

Before Requesting Help

Problem	Remedy
The unit does not work.	<ul style="list-style-type: none"> ● Check the settings (p. 5–9). ● Remove the batteries and reinstall them to reset the unit.
The unit does not ring.	<ul style="list-style-type: none"> ● The RINGER selector is set to OFF. Set to HIGH or LOW (p. 8).
You cannot dial.	<ul style="list-style-type: none"> ● Check that the dialing mode selection is correct (p. 8). ● Dial lock mode is set. To cancel the mode, see page 21. ● The dialed number is restricted. To cancel, see page 22.
The other party suddenly cannot hear your voice during a conversation.	<ul style="list-style-type: none"> ● MUTE may have been pressed during the conversation. Press MUTE.
You cannot program items such as the dialing mode.	<ul style="list-style-type: none"> ● Programming is not possible when a call is put on hold. ● Do not pause for over 60 seconds while programming.
You cannot store a phone number in memory.	<ul style="list-style-type: none"> ● Programming is not possible when a call is put on hold. ● Check that the batteries are installed in the unit and that the battery power is not low. ● Do not enter a phone number more than 22 digits long.
While programming, the unit starts to ring and stops the program.	<ul style="list-style-type: none"> ● To answer the call, lift the handset or press SP-PHONE/HEADSET. Start again from the beginning after hanging up.
You cannot redial by pressing REDIAL .	<ul style="list-style-type: none"> ● If the last number dialed was more than 32 digits long, the number will not be redialed correctly.
Previously programmed information is erased.	<ul style="list-style-type: none"> ● If the batteries installed in the unit expire, programmed information may be erased. Reprogram if necessary.

Safety Instructions

Take special care to follow the safety suggestions listed below.

Installations

Environment

- 1) Do not use this unit near water—for example, near a bathtub, washbowl, sink, etc. Damp basements should also be avoided.
- 2) The unit should be kept away from heat sources such as radiators, kitchen range, etc. It also should not be placed in rooms where the temperature is less than 5°C or greater than 40°C.

Placement

- 1) Do not place heavy objects on top of this unit.
- 2) Care should be taken so that objects do not fall onto, and liquids are not spilled into, the unit. Do not subject this unit to excessive smoke, dust, mechanical vibration or shock.
- 3) Place the unit on a flat surface.

Lightning surge

This unit has already been equipped with a built-in lightning protection circuit. However, we recommend that you install lightning protection on the telephone line, if your area has a high incidence of lightning strikes.

CAUTION:

To reduce the risk of fire or injury to persons, read and follow these instructions.

1. Use only the battery(ies) specified.
2. Do not dispose of the battery(ies) in a fire. It (they) may explode.
3. Do not open or mutilate the battery(ies). Released electrolyte is corrosive and may cause burns or injury to the eyes or skin. The electrolyte may be toxic if swallowed.
4. Exercise care in handling the battery(ies) in order not to short the battery(ies) to conductive materials such as rings, bracelets, and keys. The battery(ies) and/or conductor may overheat and cause burns.
5. Do not recharge the battery(ies) provided with or identified for use with this product. The battery(ies) may leak corrosive electrolyte or explode.
6. Do not attempt to rejuvenate the battery(ies) provided with or identified for use with this product by heating. Sudden release of battery electrolyte may occur causing burns or irritation to the eyes or skin.
7. Replace all batteries at the same time. Mixing fresh and discharged batteries could increase internal cell pressure and rupture the discharged batteries. (Applies to products employing more than one separately replaceable primary battery.)
8. When installing batteries observe the proper polarity or direction. Incorrect installation can cause charging, and may result in leakage or explosion. (Applies to products employing more than one separately replaceable primary battery.)
9. Remove the battery(ies) from this product if the product will not be used for a long period of time (several months or more). During this time the battery(ies) could leak in the product.
10. Discard the “dead” battery(ies) as soon as possible. The “dead” battery(ies) may leak in the product.
11. Do not store this product, or the battery(ies) provided with or identified for use with this product, in high temperature areas. Batteries that are stored in a freezer or refrigerator for the purpose of extending shelf life should be protected from condensation during storage and defrosting. Batteries should be stabilized at room temperature prior to use after cold storage.

WARNING:

TO PREVENT FIRE OR SHOCK HAZARD, DO NOT EXPOSE THIS PRODUCT TO RAIN OR ANY TYPE OF MOISTURE.

If there is any trouble, disconnect the unit from the telephone line and connect a known working phone. If the known working phone operates properly, do not reconnect the unit to the telephone line until the trouble has been repaired. If the known working phone does not operate properly, consult your telephone company.



This equipment is designed for use on Hungary only.

In the event of problems, you should contact your equipment supplier in the first instance.

Kyushu Matsushita Electric Co., Ltd.

Manufactured by Kyushu Matsushita Electric (Malaysia) Sdn. Bhd. Johor Malaysia