

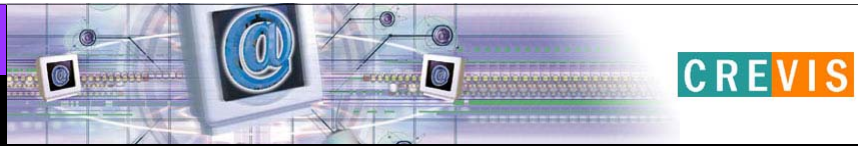

Modbus Adapter User Manual
FnIO S-Series
NA-9189

**List of Revisions**

No.	Date	Version	Revision
1	2007.12.15	1.00	Created



Contents

1. Product Specification

- 1) General Specifications
- 2) MODBUS/TCP Communication Specification

2. MODBUS Setting

- 1) Communication parameter setting
- 2) I/O allocation
- 3) MODBUS/TCP Interface

3. DeviceNet Network Installation

- 1) MODBUS/TCP Electrical Interface

4. Check Operation Status

- 1) MOD : Module Status LED
- 2) LINK : Physical Connection LED
- 3) ACTIVE : Exchange Data/Traffic Present LED
- 4) I/O : Expansion Module Status LED
- 5) Field Power : Field Power Status LED

1. Product Specifications

1) General Specifications

Item		Specifications	Remarks
Temperature	Operating	-0°C to +60°C (32°F to 140°F)	
	Storage	-40°C to +85°C (-40°F to 185°F)	
Humidity	Operating	5 to 95% RH (Non-condensing)	
	Storage	5 to 95% RH (Non-condensing)	
Vibration immunity		10 TO 55Hz,double amplitude of 0.75mm, 10minutes on each of 3 axes (X,Y,Z)	
Shock Immunity		Peak acceleration and duration 15g/11ms, 3 times on each of 3 axes (X,Y,Z)	
Capsuling		Din rail or screw tightening	

2) MODBUS/TCP Communication Specification

Item	Specification	Remarks
Network Protocol	MODBUS TCP, HTTP, BOOTP, 16 TCP Connection	
Network length	Up to 100m from Ethernet Hub/Switch with twisted CAT 3 UTP/STP	
Number of Nodes	Limited by Ethernet Specification	
Communication speed	10/100Mbps, Auto-negotiation, Full duplex	
Number of Expansion I/O	Max. 32 Slots	
Interface Connector	RJ-45 socket	
Indicator	5LEDS 1Green/Red, Module Status (MOD) 1Green,Physical Connection (LINK) 1Green,Exchange Data/Traffic Present (ACTIVE) 1Green/Red, Expansion Module Status (I/O) 1Green,Field Power Status	
System Power	Supply voltage : 24Vdc nominal Supply voltage range : 11~28.8Vdc Protection : Output current limit (Min.1.5A) Reverse polarity protection	
Isolation	System power to internal logic : Non-isolation System power to I/O Driver : Isolation	

2. MODBUS Setting

MODBUS setting include the following configurations:

- IP-Address Setup using ARP
- IP-Address Setup using BOOTP
- I/O allocation
- MODBUS/TCP Interface

1) Communication Parameter Setting

◆ IP-Address Setup ARP

A way to change the adapter IP address could be applied using such as Command Windows (only applicable same subnet).

DOS Prompt

```
>ping 192.168.123.236 // current IP address
```

```
>arp -a // view Ethernet physical address
```

```
>arp -d 192.168.123.236 // Delete arp table
```

```
>arp -s 192.168.123.237 00-14-F7-00-00-00 // assign static arp table with new IP address  
//"00-14-F7-00-00-00" is Ethernet Address (See Adapter Label)
```

```
>ping -n1 -l 741 192.168.123.237 // assign new IP address
```

```
>arp -d* //clear all arp table
```

```
>ping 192.168.123.237 // Check response of adapter new IP address
```

After IP-Address setup using ARP.

IP Address = 192.168.123.237

Subnet Mask = 255.255.255.0

Gateway = 192.168.123.254

◆ IP-Address Setup using BOOTP

If the adapter BOOTP enable, the adapter sends BOOTP request message of 20 times every 5sec.

The following is an example of adapter IP-Address setup that can be used with a third party BOOTP sever.

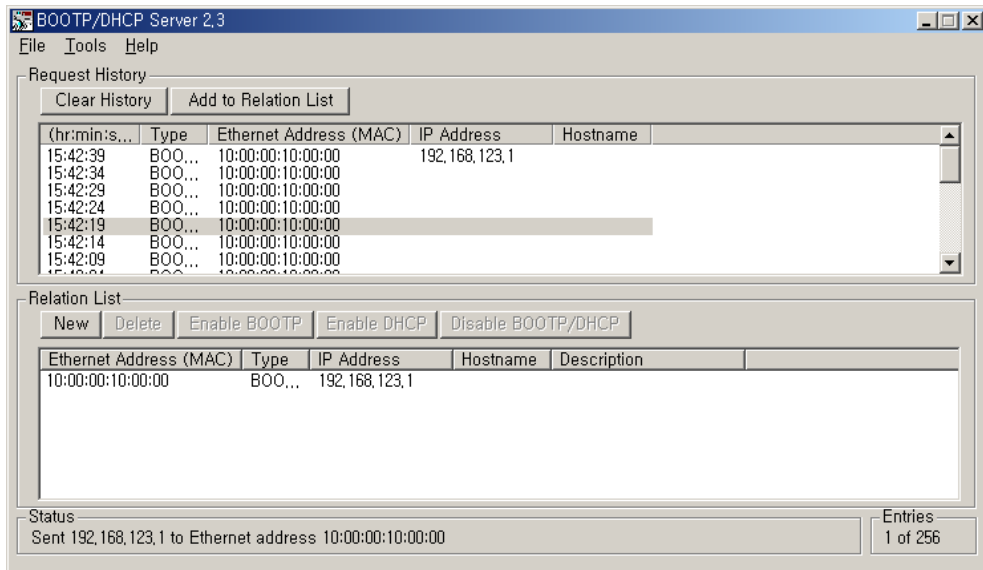

◆ **Communication Speed Setting**

- See Master Setting about communication speed setting. (Auto-negotiation, Full duplex)

2) I/O Allocation

An expansion module may have 3 types of data as I/O data, configuration parameter and memory resister. The data exchange between network adapter and expansion modules is done via an I/O process image data by FnBus protocol. The following figure shows the data flow of process image between network adapter and expansion modules.

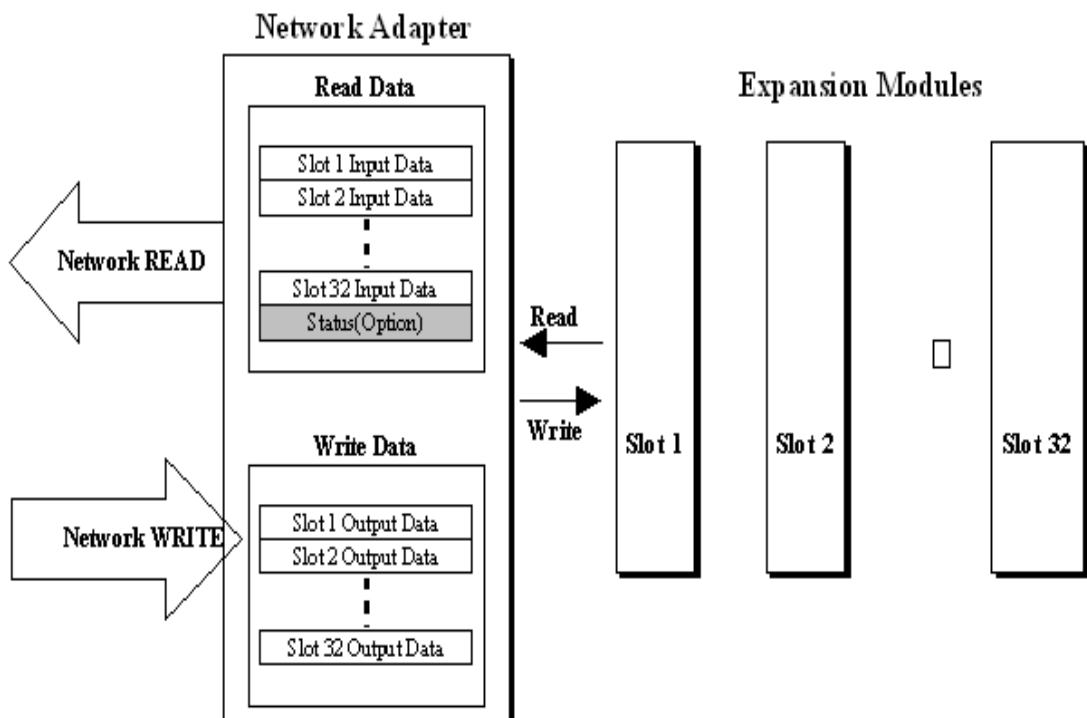

◆ Register Map

Start Address	Read/Write	Description
0x0000	Read	Process Input image registers
0x0800	Read/Write	Process output image registers
0x1000*	Read	Adapter Identification special registers.
0x1020*	Read/Write	Adapter Watchdog, other time special register.
0x1040*	Read/Write	Adapter TCP/IP special register.
0x1100*	Read/Write	Adapter Information special registers.
0x2000*	Read/Write	Expansion Slot Information Special registers

*The special register map must be accessed by read/write of every each address (one address)

◆ Bit Map

Start Address	Read/Write	Description
0x0000	Read	Process input image bits All input registers area are addressable by bit address. Size of input image bit is of input image register*16.
0x1000	Read/Write	Process output image bits All output registers area are addressable by bit address. Size of output image bit is size of output image register

◆ For Example of Input Process Image Data

Input image data depends on slot position and expansion slot data type.
Input process image data is only ordered by expansion slot position when input image mode is uncompressed (mode 0,2). But, When input image mode is compressed (mode 1,3), input process image data is ordered by expansion slot position and slot data type.

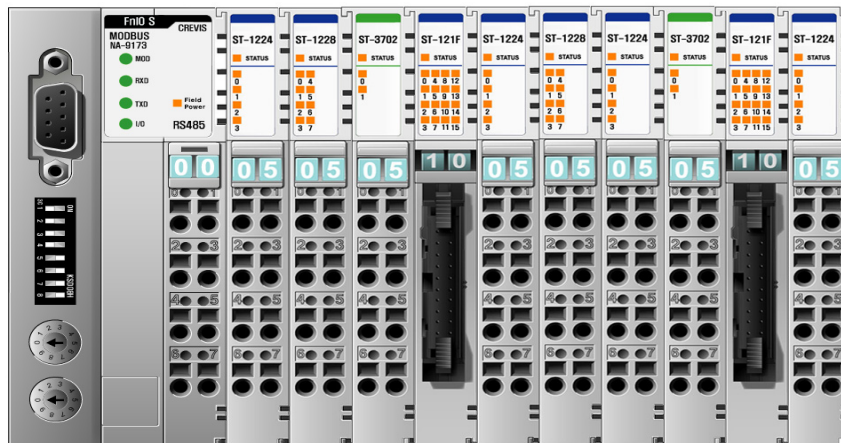

Slot Address	Module Description
0	MODBUS Adaptor
1	4-Discrete input
2	8-Discrete input
3	2-Analog input
4	16-Discrete input
5	4-Discrete input
6	8-Discrete input
7	4-Discrete input
8	2-Analog input
9	16-Discrete input
10	4-Discrete input

◆ **Input Process Image Mode#0**
(Status(1word) + Uncompressed Input Processing Data)

WORD#	#15	#14	#13	#12	#11	#10	#9	#8	#7	#6	#5	#4	#3	#2	#1	#0
+0	EW	0	0	0	0	0	0	0	0	FP	FnBUS Status					
+1	Discrete Input 8points (slot#2)						Empty,Always 0				Discrete Input 4points (slot#1)					
+2	Analog Input CH0 High byte (slot#3)						Analog Input CH0 low byte (slot#3)									
+3	Analog Input CH1 High byte (slot#3)						Analog Input CH1 low byte (slot#3)									
+4	Discrete Input high 8points (slot#4)						Discrete Input low 8points (slot#4)									
+5	Discrete Input 8points (slot#6)						Empty,Always 0				Discrete Input 4points (slot#5)					
+6	Analog Input CH0 low byte (slot#8)						Empty,Always 0				Discrete Input 4points (slot#7)					
+7	Analog Input CH1 low byte (slot#8)						Analog Input CH0 high byte (slot#8)									
+8	Discrete Input low 8points (slot#9)						Analog Input CH1 high byte (slot#8)									
+9	Empty,Always 0				Discrete Input 4points (slot#10)				Discrete Input high 8points (slot#9)							

● **FnBus Status:**

- | | |
|-------------------------------|-------------------------------|
| 0 : Normal Operation | 1 : FnBus Standby |
| 2 : FnBus Communication Fault | 3 : Slot Configuration Failed |
| 4 : No Expansion Slot | |

● **FP(Field Power)**

- | | |
|---------------------------|---------------------------|
| 0 : 24Vdc Field Power On. | 1 : 24Vdc Field Power Off |
|---------------------------|---------------------------|

● **EW(MODBUS Error Watchdog)**

- | |
|--|
| 0 : No Error Watchdog |
| 1 : Error Watchdog once more since its last restart, clear counters operation or power-up. |

◆ Input Process Image Mode#1 (Status(1word) + compressed Input Processing Data)

WORD#	#15	#14	#13	#12	#11	#10	#9	#8	#7	#6	#5	#4	#3	#2	#1	#0
+0	EW	0	0	0	0	0	0	0	FP	FnBUS Status						
+1	Analog Input CH0 High byte (slot#3)								Analog Input CH0 low byte (slot#3)							
+2	Analog Input CH1 High byte (slot#3)								Analog Input CH1 low byte (slot#3)							
+3	Analog Input CH0 high byte (slot#8)								Analog Input CH0 low byte (slot#8)							
+4	Analog Input CH1 high byte (slot#8)								Analog Input CH1 low byte (slot#8)							
+5	Discrete Input low 8points (slot#4)								Discrete Input 8points (slot#2)							
+6	Discrete Input 8points (slot#6)								Discrete Input high 8points (slot#4)							
+7	Discrete Input high 8points (slot#9)								Discrete Input low 8points (slot#9)							
+8	Discrete Input 4points (slot#10)				Discrete Input 4points (slot#7)				Discrete Input 4points (slot#5)				Discrete Input 4points (slot#1)			

- Input Assembly Priority
 - 1) Analog IO Data(Word Type)
 - 2) 8 or 16 points Discrete IO Data(Word Type)
 - 3) 4 points IO Data(Bit Type)
 - 4) 2 point IO Data(Bit Type)

◆ Input Process Image Mode#2
(Uncompressed Input Processing Data without Status), default input image

WORD#	#15	#14	#13	#12	#11	#10	#9	#8	#7	#6	#5	#4	#3	#2	#1	#0
+0	Discrete Input 8points (slot#2)								Empty,Always 0				Discrete Input 4points (slot#1)			
+1	Analog Input CH0 High byte (slot#3)								Analog Input CH0 low byte (slot#3)							
+2	Analog Input CH1 High byte (slot#3)								Analog Input CH1 low byte (slot#3)							
+3	Discrete Input high 8points (slot#4)								Discrete Input low 8points (slot#4)							
+4	Discrete Input 8points (slot#6)								Empty,Always 0				Discrete Input 4points (slot#5)			
+5	Analog Input CH0 low byte (slot#8)								Empty,Always 0				Discrete Input 4points (slot#7)			
+6	Analog Input CH1 low byte (slot#8)								Analog Input CH0 high byte (slot#8)							
+7	Discrete Input low 8points (slot#9)								Analog Input CH1 high byte (slot#8)							
+8	Empty,Always 0				Discrete Input 4points (slot#10)				Discrete Input high 8points (slot#9)							

◆ Input Process Image Mode#3 (Compressed Input Processing Data without Status)

WORD#	#15	#14	#13	#12	#11	#10	#9	#8	#7	#6	#5	#4	#3	#2	#1	#0
+0	Analog Input CH0 High byte (slot#3)							Analog Input CH0 low byte (slot#3)								
+1	Analog Input CH1 High byte (slot#3)							Analog Input CH1 low byte (slot#3)								
+2	Analog Input CH0 high byte (slot#8)							Analog Input CH0 low byte (slot#8)								
+3	Analog Input CH1 high byte (slot#8)							Analog Input CH1 low byte (slot#8)								
+4	Discrete Input low 8points (slot#4)							Discrete Input 8points (slot#2)								
+5	Discrete Input 8points (slot#6)							Discrete Input high 8points (slot#4)								
+6	Discrete Input high 8points (slot#9)							Discrete Input low 8points (slot#9)								
+7	Discrete Input 4points (slot#10)				Discrete Input 4points (slot#7)			Discrete Input 4points (slot#5)				Discrete Input 4points (slot#1)				

- * FnBus use the byte-oriented register mapping.
- * Size of input image bit is size of input image register

- Input Assembly Priority:
 - 1) Analog Input Data (Word type)
 - 2) 8 or 16 points Discrete Input Data (Byte type)
 - 3) 4 Points Input Data(Bit type)
 - 4) 8 Points Input Data(Bit Type)

◆ For Example of Output Process Image Data

Output image data depends on slot position and expansion slot data type. Output process image data is only ordered by expansion slot position when output image mode is uncompressed (mode 0). But, When output image mode is compressed (mode 1), output process image data is ordered by expansion slot position and slot data type.

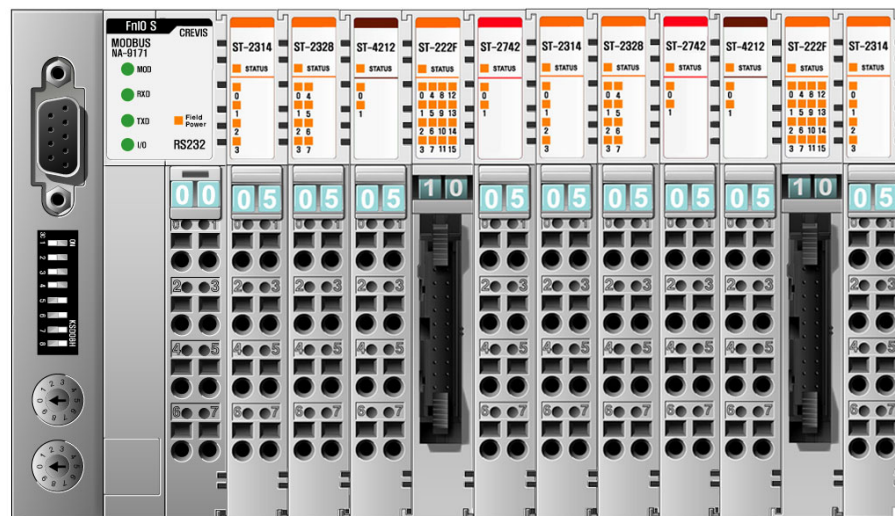

Slot Address	Module Description
0	MODBUS Adaptor
1	4-Discrete Output
2	8-Discrete Output
3	2-Analog Output
4	16-Discrete Output
5	4-Discrete Output
6	8-Discrete Output
7	2-Relay Output
8	2-Relay Output
9	2-Analog Output
10	16-Discrete Output
11	4-Discrete Output

◆ **Output Process Image Mode#0**
(Uncompressed Output Processing Data), default output image

WORD#	#15	#14	#13	#12	#11	#10	#9	#8	#7	#6	#5	#4	#3	#2	#1	#0
+0	Discrete output 8points (slot#2)						Empty,Don't Care				Discrete output 4points (slot#1)					
+1	Analog output CH0 High byte (slot#3)						Analog output CH0 low byte (slot#3)									
+2	Analog output CH1 High byte (slot#3)						Analog output CH1 low byte (slot#3)									
+3	Discrete output high 8points (slot#4)						Discrete output low 8points (slot#4)									
+4	Discrete output 8points (slot#6)						Empty,Don't Care				Discrete Input 4points (slot#5)					
+5	Empty,Don't Care						Discrete output 2points (slot#8)		Empty,Always 0						Discrete output 2points (slot#7)	
+6	Analog output CH0 high byte (slot#9)						Analog output CH0 low byte (slot#9)									
+7	Analog output CH1 high byte (slot#9)						Analog output CH1 low byte (slot#9)									
+8	Discrete Output high 8points (slot#10)						Discrete Output low 8points (slot#10)									
+9	Empty,Don't care						Empty,Don't care				Discrete Out 4points (Slot#11)					

◆ **Output Process Image Mode#1 (Compressed Output Processing Data)**

WORD#	#15	#14	#13	#12	#11	#10	#9	#8	#7	#6	#5	#4	#3	#2	#1	#0
+0	Analog output CH0 High byte (slot#3)								Analog output CH0 low byte (slot#3)							
+1	Analog output CH1 High byte (slot#3)								Analog output CH1 low byte (slot#3)							
+2	Analog output CH0 high byte (slot#9)								Analog output CH0 low byte (slot#9)							
+3	Analog output CH1 high byte (slot#9)								Analog output CH1 low byte (slot#9)							
+4	Discrete output low 8points (slot#4)								Discrete output 8points (slot#2)							
+5	Discrete output 8points (slot#6)								Discrete output high 8points (slot#4)							
+6	Discrete Input high 8points (slot#10)								Discrete Input low 8points (slot#910)							
+7	Discrete output 2points (slot#8)		Discrete output 2points (slot#7)		Discrete output 4points (slot#11)			Discrete output 4points (slot#5)			Discrete output 4points (slot#1)					

*FnBus uses the bytes-oriented register mapping.

*Size of output image bit is size of output image register.

● Output Assembly Priority:

- 1) Analog Output Data (Word type)
- 2) 8 or 16 points Discrete Output Data (Byte type)
- 3) 4 Points Output Data (Bit type)
- 4) 2 Points Output Data (Bit Type)

3) MODBUS /TCP INTERFACE

◆ MODBUS/TCP Protocol

The MODBUS messaging service provides a Client/Sever communication between devices connected on an Ethernet TCP/IP network. All MODBUS/TCP message are sent via TCP on registered port 502.

◆ Comparison of MODBS/TCP And MODBUS/RTU

This header providers some differences compared to the MODBUS RTU application data unit used on serial line:

- The MODBUS 'Slave address' filed usually used on MODBUS Serial Line is replaced by a single byte 'Unit Identifier' within the MBAP Header. The 'Unit Identifier' is used to communicate via devices such as bridges, routers and gateways that use a single IP address to support multiple independent MODBUS end unit.
- All MODBUS requests and responses are designed in such a way that the recipient can

verify that a message is finished. For function codes where the MODBUS PDU has fixed length, the function code alone is sufficient. For function codes carrying a variable amount of data in the request or response, the data field includes a byte count.

- When MODBUS is carried over TCP, additional length information is carried in the MBAP header to allow the recipient to recognize message boundaries even if the message has been split into multiple packets for transmission. The existence of explicit and implicit length rules, and use of CRC-32 error Check code(on Ethernet) results in an infinitesimal chance of undetected corruption to a request or response message.

◆ MODBUS/TCP

MBAP Header	Function	Data
7 Char	1 char	Up to 252 char(s)

◆ MODBUS/RTU

Start	Address	Function	Data	CRC Check	End
≥3.5Char	1 chars	1 chars	Up to 252 char(s)	2 chars	≥3.5Char

◆ MODBUS/TCP MBAP Header

The MBAP (MODBUS Application Protocol) header contains the following fields.

Field	Length	Description	Client	Server
Transaction Identifier	2bytes	Identification of a MODBUS Request/Response transaction.	Initialized by the client	Recopied by the server from the received
Protocol Identifier	2bytes	0 = MODBUS protocol	Initialized by the client	Recopied by the server from the received
Length	2bytes	Number of following bytes	Initialized by the client (Request)	Recopied by the server from the received (Response)
Unit Identifier	1bytes	Identification of a remote slave connected on a serial line or on other buses.	Initialized by the client	Recopied by the server from the received

- ° Transaction Identifier - It is used for transaction pairing, the MODBUS server copies in the response the transaction identifier of the request.
- ° Protocol Identifier - It is used for intra-system multiplexing. The MODBUS protocol is identified by the value 0.
- ° Length - The length field is a byte count of the following fields, including the Unit Identifier and data fields.
- ° Unit Identifier - This field is used for intra-system routing purpose. Typically MODBUS server must be returned with the same value set by MODBUS client.

◆ Support MODBUS Function Codes

Function Code	Function	Description	Unicast/Broadcast
1(0x01)	Read Coils	Read output bit	Unicast
2(0x02)	Read Discrete Inputs	Read input bit	Unicast
3(0x03)	Read Holding Registers	Read Output Word	Unicast
4(0x04)	Read Input Registers	Read input word	Unicast
5(0x05)	Write Single Coil	Write one bit output	Unicast/Broadcast
6(0x06)	Write Single Register	Write one word output	Unicast/Broadcast
8(0x08)	Diagnostics (Serial Line only)	Read diagnostic register	Unicast
15(0x0F)	Write Multiple Coil	Write a number of output bits	Unicast/Broadcast
16(0x10)	Write Multiple registers	Write a number of output words	Unicast/Broadcast
23(0x17)	Read/Write Multiple registers	Read a number of input words / Write a number of output words	Unicast

3. MODBUS Network Installation

MODBUS/TCP Network Set up is like following figure1.

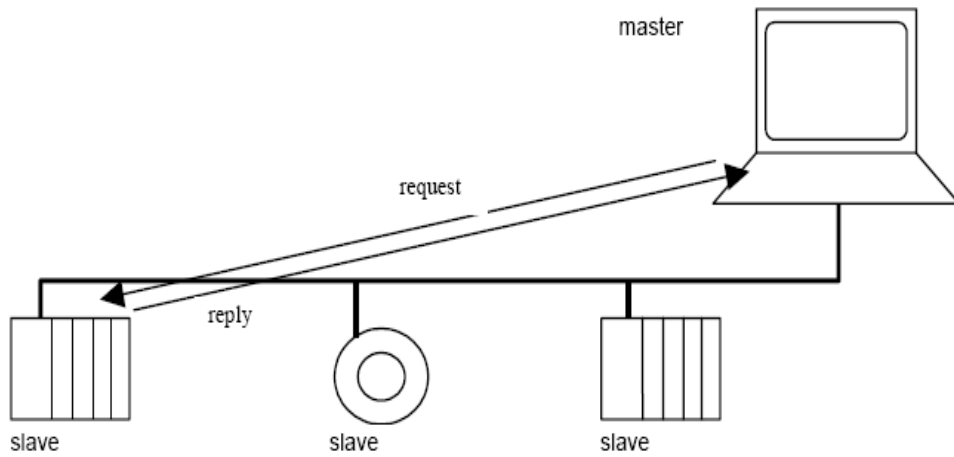

Figure 1 MODBUS Network

1) MODBUS/TCP Electrical Interface

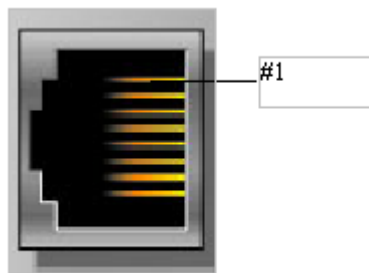
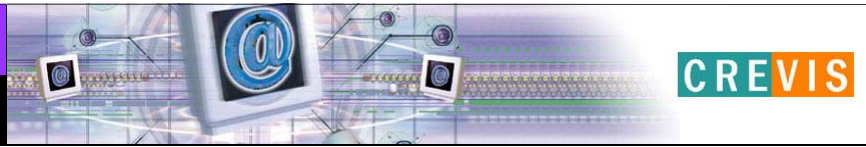

Figure 2 MODBUS/TCP MODBUS Interface

RJ-45	Signal Name	Description
1	TD+	Transmit +
2	TD-	Transmit -



3	RD+	Received +
4	---	
5	---	
6	RD-	Received -
7	---	
8	---	
Case	Shield	

4. Check Operation Status

When all installation and configuration processes are complete, the adaptor module status LED (MOD LED) and Communication status LED shall be lit in a green color. If not, it indicates that an error has occurred. See the following table for proper measures.

1) MOD : Module Status LED

State	LED is	Description
No Power	Off	No power is supplied to the unit
Device Operational	Green	The unit is operating in normal condition
Device in Standby	Flashing Green	The device needs commissioning due to configuration missing, incomplete or incorrect.
MODBUS Error	Green/Red Toggle	MODBUS error such as watchdog error, etc
Minor Fault	Flashing Red	Recoverable Fault -EEPROM sum check error
Unrecoverable Fault	Red	The device has an unrecoverable fault. -Memory error or CPU watchdog error.

2) LINK : Physical Connection LED

State	LED is	Description
Not Powered	Off	Device is may be not powered
Adapter physical corrected	Green	Adapter Ethernet Controller physically connected.

3) ACTIVE : Exchange Data/Traffic Present LED

State	LED is	Description
Not Powered	Off	Device is may be not powered
Adapter physical corrected	Green Flashing	Adapter(Slave) exchange data/Traffic present. About 10msec flashing

4) I/O : Expansion Module Status LED

State	LED is	To Indicate
-------	--------	-------------

Not Powered No Expansion Module	Off	Device has no expansion module or may be not powered
FnBus On-line Do not Exchanging I/O	Flashing Green	FnBus is Normal but does not exchange I/O data (Passed the expansion module configuration).
FnBus Connection, Run Exchange I/O	Green	Exchange I/O data
FnBus connection fault During Exchanging I/O	Flashing Red	One or more expansion module occurred in fault state - Changed expansion module configuration - FnBus communication failure
Expansion Configuration Failed	Red	Failed to initialize expansion module - Detected invalid expansion module ID. - Overflowed Input/Output Size - Too many expansion module - Initial protocol failure - Mismatch vender code between adapter and expansion module.

5) Field Power : Field Power Status LED

State	LED is	To Indicate
Not Supplied Field Power	Off	Not supplied 24Vdc field power
Supplied Field Power	Green	Supplied 24Vdc field power

CREVIS Co., Ltd

D-11F, Digital Empire Bldg., 980-3, Youngtong-Dong,
Youngtong-Gu, Suwon, GyeongGi-Do, Korea

TEL : +82-31-206-8077~8

Sales : +82-31-273-6452

FAX : +82-31-206-8079

E-mail : crevis@crevis.co.kr

Homepage : <http://crevis.co.kr>