

Portable Automobile Navigation System

Product User Manual

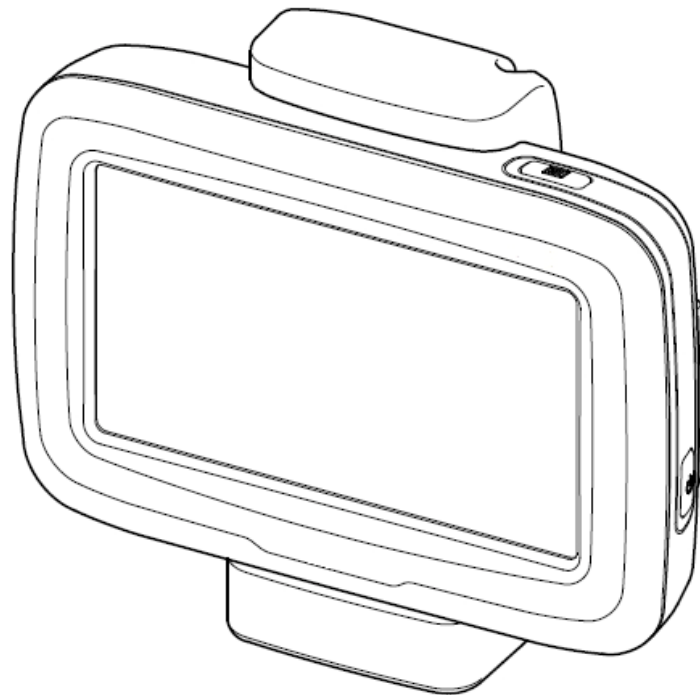

Registered info

HOLUX and GP smile are trademarks of HOLUX Technology, Inc.

All other trademarks belong to registered companies.

Note

- The contents of this manual will be modified without further notice.
- The operation temperature for the product is between -10°C ~ 50°C .
- Operating or recharging in an environment with a temperature over 50°C might cause the system to malfunction. However, this should be considered a normal phenomenon. Please do not operate under extreme temperatures.

Safety Precautions

- The device should only be used with the supplied batteries.
- About the battery
 1. A Lithium battery is built into the device. To prevent fire or skin burns, do not disassemble, pierce, impact, or expose the battery to fire. The battery will crack, explode, or release dangerous chemicals if placed in a fire.
- Important instructions
 1. Note: Replacing with an incorrect battery may result in an explosion. When disposing of the battery, follow the instructions. The replacement battery must be a factory approved original.
 2. Regulations must be observed when recycling or disposing of batteries.
 3. The battery should only be used in this device.

Warranty Statement

- This warranty applies to parts and services that are manufactured and sold through Holux Technology Inc. The local area covered is Taiwan; the warranty length is one year from date of purchase (starting from the date on the sales receipt). Under normal user operation, Holux Technology provides free repair services.
 - ❖ After repair, the replaced parts are the properties of Holux Technology Inc.
- Holux Technology is not responsible for providing repairs or replacements of any software; Holux Technology does not provide any warranty service for third party software/hardware.
- Important instructions

Note: This warranty does not cover damage or malfunction from the below causes: unauthorized disassembly/modification of unit, abuse or incorrect usage, accidental and other unpreventable causes, operation under variables mentioned that are different from those in this product user manual, using parts not made or sold by Holux Technology, or repairs done by anyone other than Holux Technology and authorized retail/service providers.

- ❖ Expendable parts are not covered in the warranty.
 - ❖ Holux Technology is not responsible for any program, data, or portable storage media damages or loss. Please contact your local Holux Technology authorized service provider to learn more about geographical limitations, proof of purchase requests, response time agreements, and other specific maintenance service requests.

Technical Support

- If there are any questions regarding the use of this product, please log on to the website www.holux.com and see the FAQ.

Maintenance Service

HOLUX Technology, Inc.

+886-3-6687000

Web Site: www.holux.com

or

Contact your nearest dealer, for further support.

HOLUX Technology, Inc.

www.holux.com

Table of Contents

Safety Precautions.....	ii
Warranty Statement	iii
Technical Support.....	iv
Maintenance Service.....	iv
Preface	1
Precautions and Notices	1
Copyright	2
Important Notice	2
First time use.....	3
Package Contents	3
Basic Operation	4
Introduction	4
Front View.....	4
Rear View.....	4
Accessories	5
Cradle	5
Optional Accessories.....	5
Getting Started	6
Install Cradle	6
Remove Cradle	7
Install/ Remove Battery.....	8
Device connection Diagram	9
Charging Battery (Optional)	11

Preface

We appreciate your purchase of the HOLUX car navigation.

Please read all instructions thoroughly for a full understanding of the products' features.

Precautions and Notices

- For your own safety, do not operate the controls of the product while driving.
- Use this product prudently. The product is intended to be used only as a navigation aid. It is not for precise measurement of direction, distance, location or topography.
- The calculated route is for reference only. It is the user's responsibility to follow the traffic signs and local regulations along the roads.
- GPS is operated by the United States government, which is solely responsible for the performance of GPS. Any change to the GPS system can affect the accuracy of all GPS equipments.
- When you are inside a tunnel or building, GPS positioning is not available.
- A minimum of 4 GPS satellite signals is needed to determine current GPS position. Signal reception can be affected by situations such as bad weather or dense overhead obstacles (e.g. trees and tall buildings).
- Other wireless devices in the vehicle might interfere with the reception of satellite signals and cause the reception to be unstable.

Copyright

Without the written consent of HOLUX Technology, Inc, this manual, including the product and the software, may not be duplicated, transmitted, recorded or saved on storage devices. Furthermore, it shall not be translated under any circumstances into any other languages.

Copyright ©2012 HOLUX Technology, Inc. All rights reserved.

Important Notice

Please thoroughly read this manual of operating instructions and explanations. Only use original factory approved batteries and accessories to prevent unexpected damage. If the correct procedures were not followed for operation or incompatible accessories were connected, this is a violation of the warrantee agreement and will automatically void the warrantee. This may also cause personal safety issues.

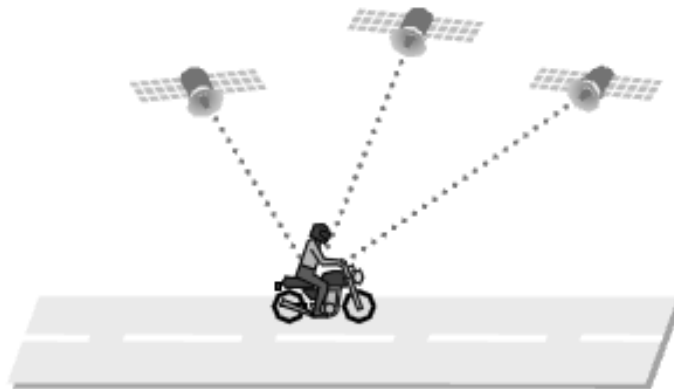

First time use

Package Contents

Your product should include the following accessories:

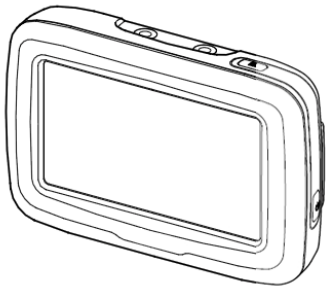

Device

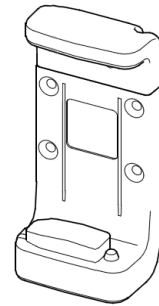

Cradle

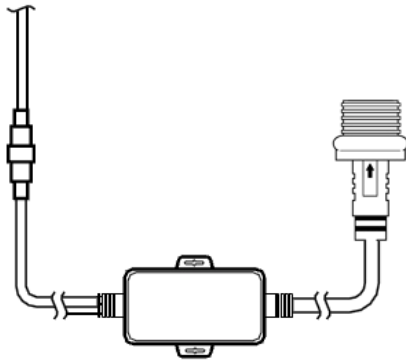

DC-DC Adapter

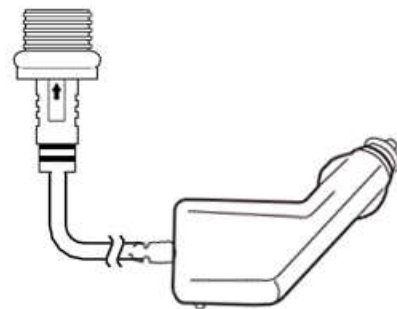

Car Charger

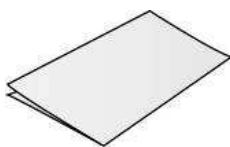

Quick Guide



CD-ROM



Warranty Card

Basic Operation

Introduction

Front View

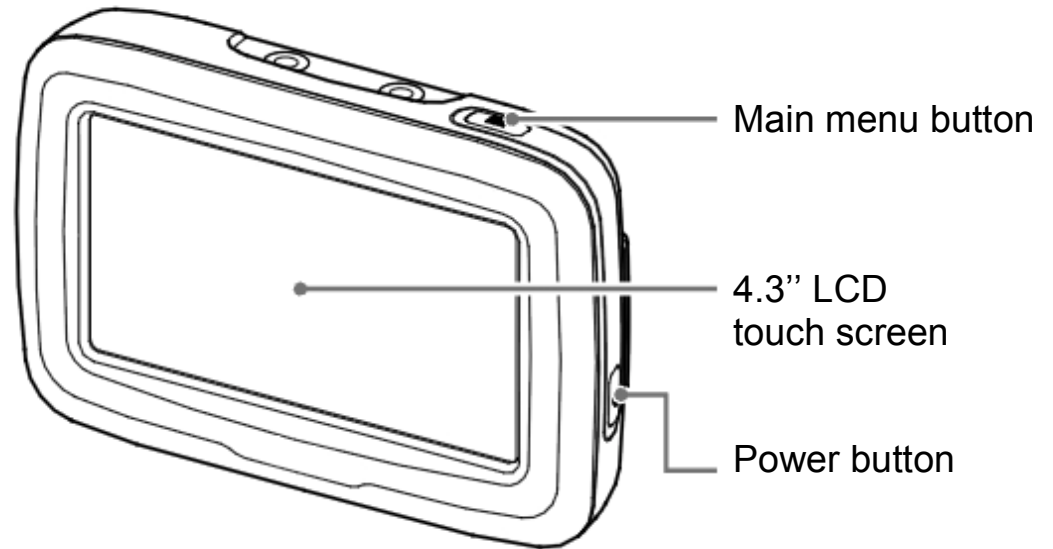

Rear View

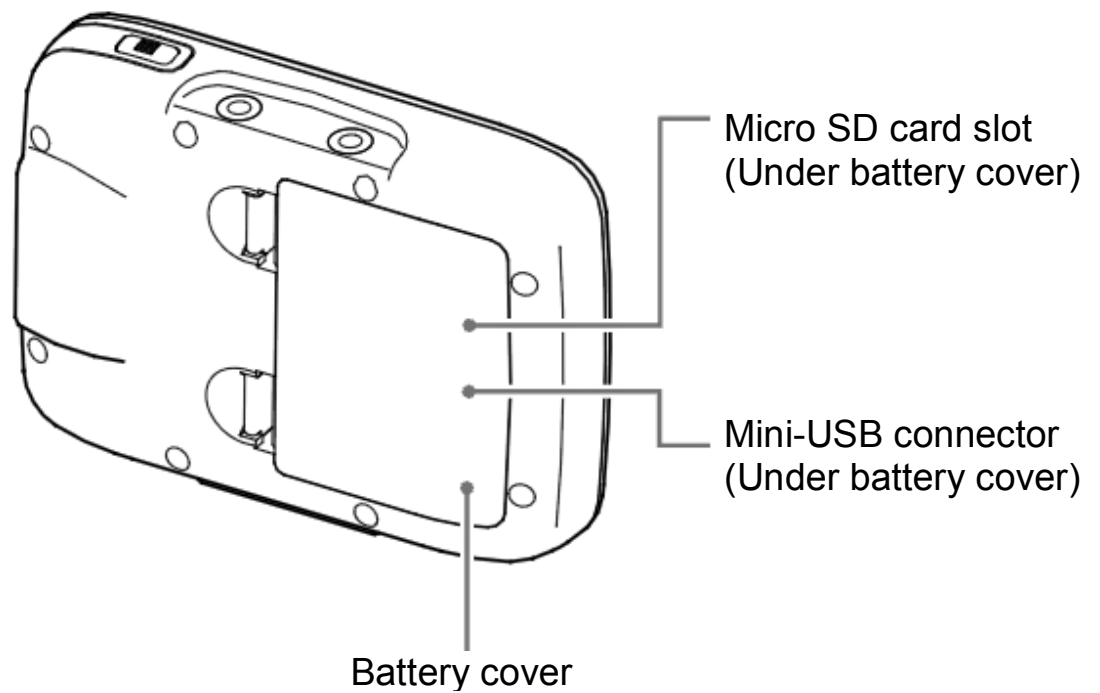

Accessories

Cradle

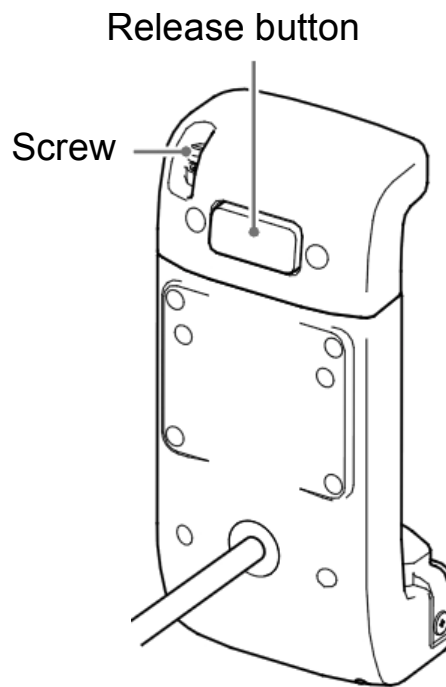
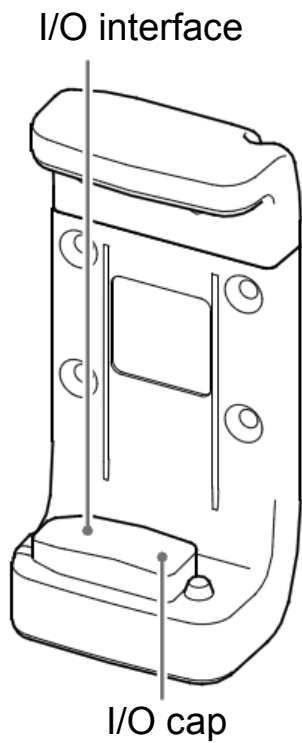

Optional Accessories



Extension UART cable

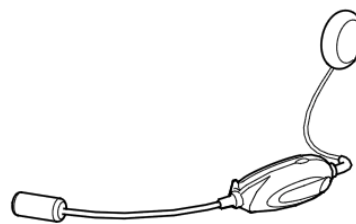

Bluetooth headset

Getting Started

Install Cradle

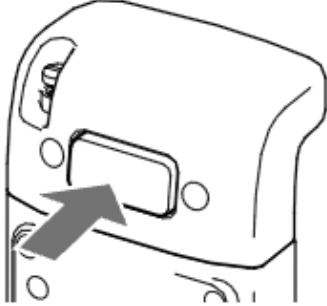
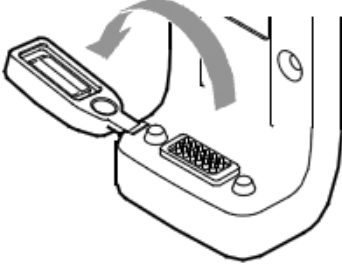
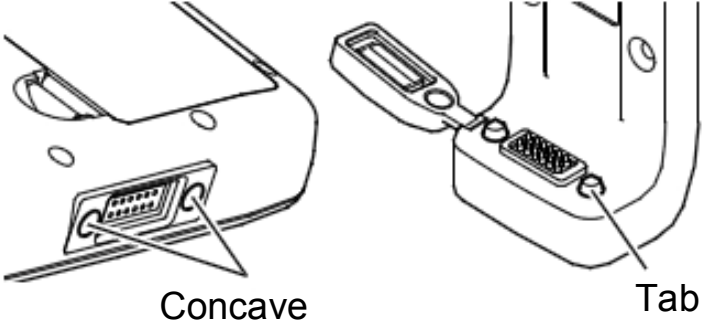
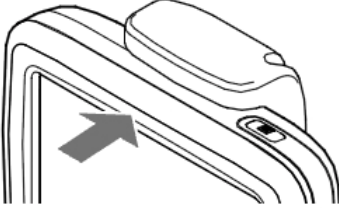
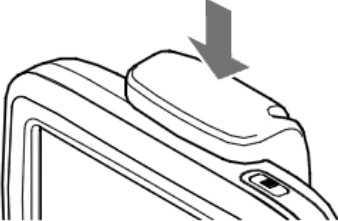
<p>1. Press release button of cradle back.</p>	
<p>2. Open the I/O cap.</p>	
<p>3. Insert the device concave into the cradle tabs.</p> <p>※ Please make sure the I/O pin is not wet or dirty.</p>	
<p>4. Slide the GPS into the cradle fitting holes to secure.</p>	
<p>5. Gently press down the cradle top until the device is tightly fixed with the bracket.</p>	

6. Tighten the screw on the back of the cradle

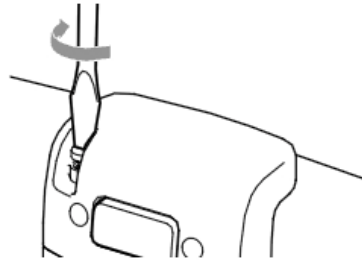

Remove Cradle

1. Loosen the screw on the back of the cradle.

2. Press release button

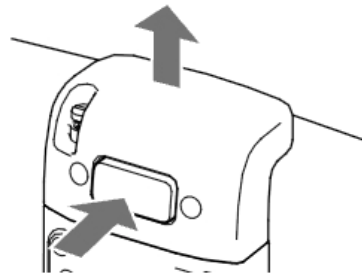

3. Remove the device

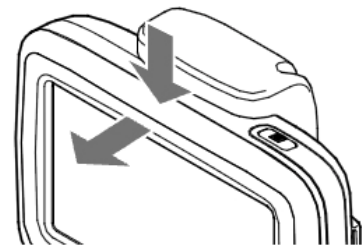

4. Restore the I/O cap

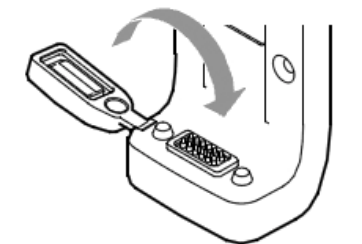

Install/ Remove Battery

Please make sure the battery is installed before using the device.

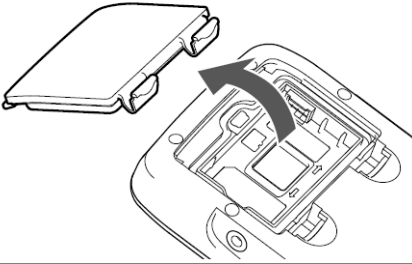
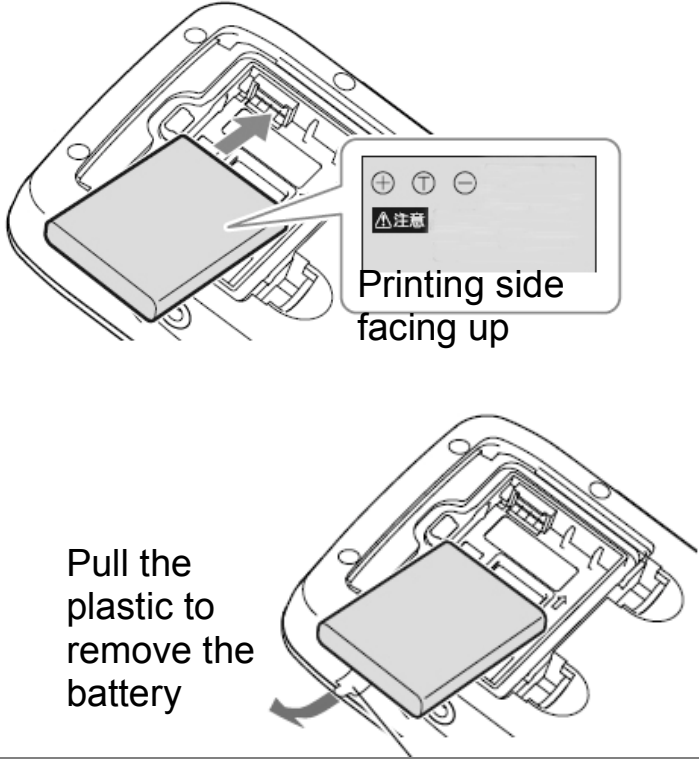
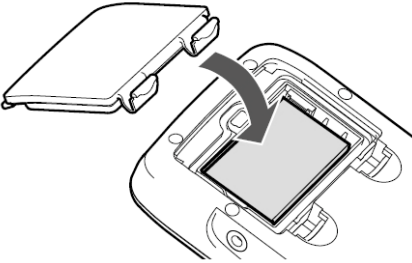
<p>1. Open the battery lid</p>	
<p>2. Install or Remove the battery</p>	 <p>Printing side facing up</p> <p>Pull the plastic to remove the battery</p>
<p>3. Restore the battery lid.</p>	

Device connection Diagram

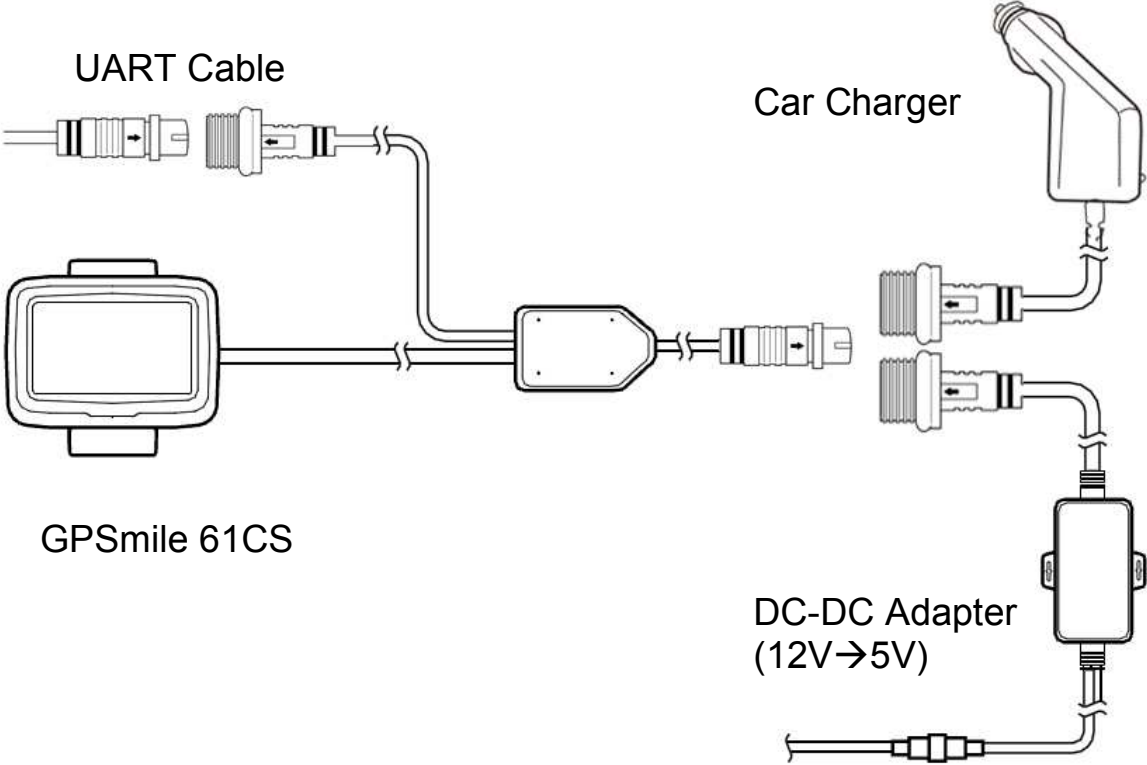

Install SD Card (Optional)

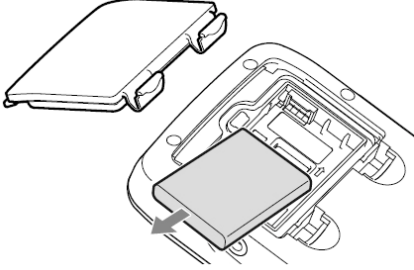
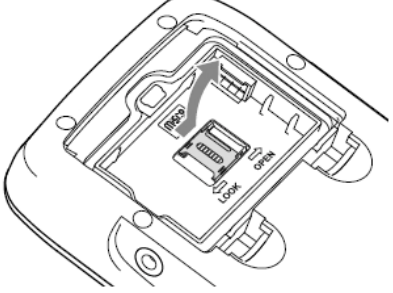
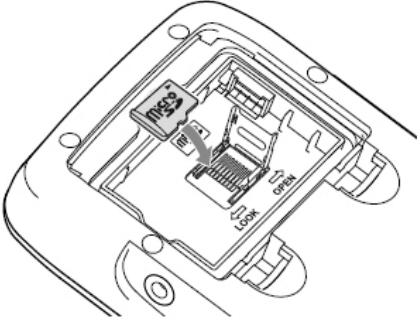
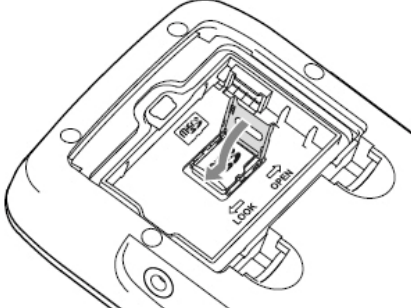
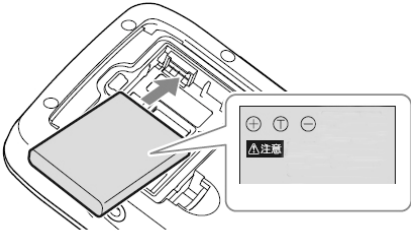
<p>1. Open the battery lid and remove the battery.</p>	
<p>2. Open SD card slot</p>	
<p>3. Insert SD card with its chip facing down and flat into the SD card slot.</p>	
<p>4. Push upward to lock the SD card slot.</p>	
<p>5. Put into the battery.</p>	

6. Restore the battery lid.

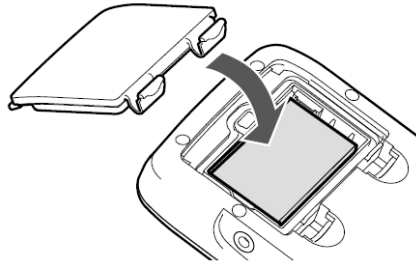

Charging Battery (Optional)

Connect the Cradle or AC adapter to charging. The charging temperature for the product is between 0°C~50°C.

1. Open the battery lid

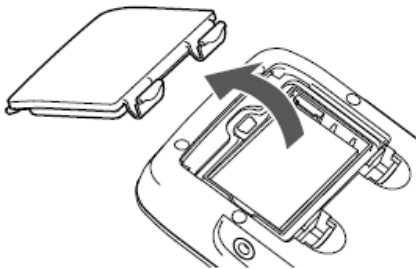

2. Connect the USB adapter to a wall outlet.

