



# LCD

---

# Projector

---

# User Manual

---

# S120

MODEL LVP-S120A

ENGLISH

FRANÇAIS

ESPAÑOL

APPENDIX

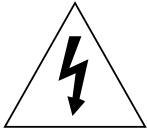
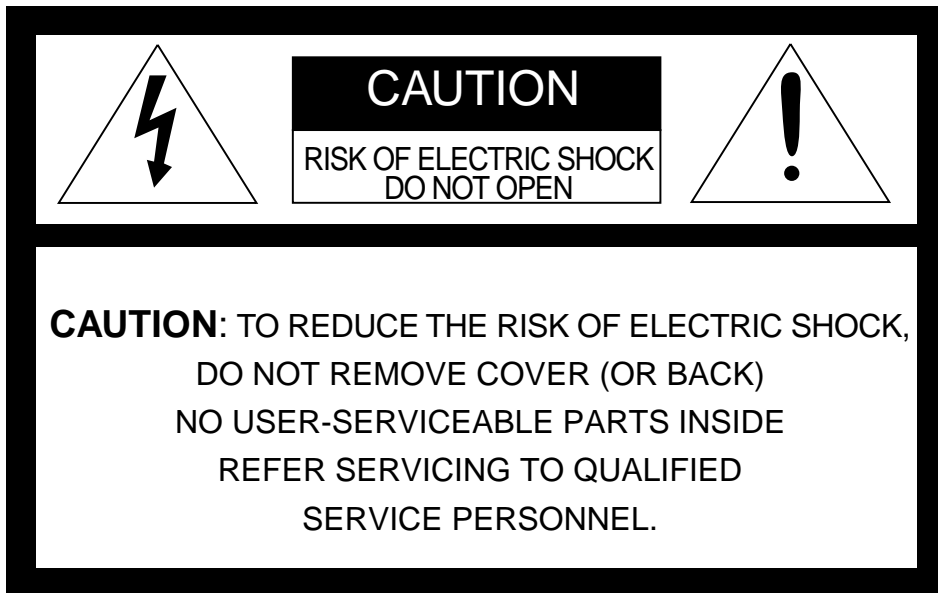

The lightning flash with arrowhead symbol, within an equilateral triangle, is intended to alert the user to the presence of uninsulated “dangerous voltage” within the product’s enclosure that may be of sufficient magnitude to constitute a risk of electric shock.



The exclamation point within an equilateral triangle is intended to alert the user to the presence of important operating and maintenance (servicing) instructions in the literature accompanying the appliance.

### **WARNING:**

TO PREVENT FIRE OR SHOCK HAZARD, DO NOT EXPOSE THIS APPLIANCE TO RAIN OR MOISTURE.

### **CAUTION:**

TO PREVENT ELECTRIC SHOCK, DO NOT USE THIS (POLARIZED) PLUG WITH AN EXTENSION CORD, RECEPTACLE OR OTHER OUTLET UNLESS THE BLADES CAN BE FULLY INSERTED TO PREVENT BLADE EXPOSURE.

### **NOTE:**

SINCE THIS PROJECTOR IS PLUGGABLE EQUIPMENT, THE SOCKET-OUTLET SHALL BE INSTALLED NEAR THE EQUIPMENT AND SHALL BE EASILY ACCESSIBLE.

### **WARNING**

Use the attached specified power-supply cord. If you use another cord, it may cause interference with radio and television reception.

Use the attached RGB cable, RS-232C cable with this equipment so as to keep interference within the limit of a Class A device.

**The projector automatically shuts off when the lamp is used up in about 2,000 hours, and the projector wont turn on until lamp is replace.**

**DO NOT LOOK DIRECTLY INTO THE LENS WHEN PROJECTOR IS IN THE POWER ON MODE.**

# Contents

---

Important safeguards .....	4
Overview of the projector .....	6
Overview of the remote control .....	8
Battery installation .....	9
Preparing the projector for operation .....	10
Basic connections .....	12
Projector + AV equipment .....	12
Cables and adapters .....	12
Projector + IBM PC or IBM PC compatibles .....	13
Projector + Macintosh .....	14
To operate projector power ON .....	15
Menu operation .....	17
Picture adjustment .....	20
Advanced feature for presentation .....	22
Expand .....	22
Still .....	22
PC-CARD .....	23
Advanced feature with PC .....	25
PCV .....	25
Mouse remote control .....	31
Replacement of a light source lamp .....	32
Maintenance .....	34
Troubleshooting .....	35
Indicators .....	36
Specifications .....	37
Replacement parts list .....	37

## Trademark, Registered trademark

Apple, Macintosh are registered trademarks of Apple Computer Inc.

IBM, VGA, PS/2, OS/2 are trademarks or registered trademarks of International Business Machines Corporation.

Microsoft®, Windows®, Windows® 95, Windows NT® are registered trademarks of Microsoft in the U.S. and other countries.

Other brand or product names are trademarks or registered trademarks of their respective holders.

# Important safeguards

PLEASE READ ALL THESE INSTRUCTIONS REGARDING YOUR LCD PROJECTOR AND RETAIN THEM FOR FUTURE REFERENCE. FOLLOW ALL WARNINGS AND INSTRUCTIONS MARKED ON THE LCD PROJECTOR.

1. **Read instructions**  
All the safety and operating instructions should be read before the appliance is operated.
  2. **Retain instructions**  
The safety and operating instructions should be retained for future reference.
  3. **Warnings**  
All warnings on the appliance and in the operating instructions should be adhered to.
  4. **Instructions**  
All operating instructions must be followed.
  5. **Cleaning**  
Unplug this projector from the wall outlet before cleaning it. Do not use liquid aerosol cleaners. Use a damp soft cloth for cleaning.
  6. **Attachments and equipment**  
Never add any attachments and/or equipment without the approval of the manufacturer as such additions may result in the risk of fire, electric shock or other personal injury.
  7. **Water and moisture**  
Do not use this projector near water or in contact with water.
  8. **Accessories**  
Do not place this projector on an unstable cart, stand, tripod, bracket or table. Use only with a cart, stand, tripod bracket, or table recommended by the manufacturer or sold with the projector. Any mounting of the appliance should follow the manufacturer's instructions and should use a mounting accessory recommended by the manufacturer.
- An appliance and cart combination should be moved with care. Quick stops, excessive force and uneven surfaces may cause the appliance and cart combination to overturn.
- 
9. **Ventilation**  
Slots and openings in the cabinet are provided for ventilation, ensuring reliable operation of the projector and to protect it from overheating. Do not block these openings or allow them to be blocked by placing the projector on a bed, sofa, rug, or bookcase. Ensure that there is adequate ventilation and that the manufacturer's instructions have been adhered to.
  10. **Power sources**  
This projector should be operated only from the type of power source indicated on the marking label. If you are not sure of the type of power, please consult your appliance dealer or local power company.
  11. **Power-cord protection**  
Power-supply cords should be routed so that they are not likely to be walked on or pinched by items placed upon or against them. Pay particular attention to cords at plugs, convenience receptacles, and points where they exit from the appliance.
  12. **Overloading**  
Do not overload wall outlets and extension cords as this can result in a fire or electric shock.
  13. **Objects and liquids**  
Never push objects of any kind through openings of this projector as they may touch dangerous voltage points or short-out parts that could result in a fire or electric shock. Never spill liquid of any kind on the projector.
  14. **Servicing**  
Do not attempt to service this projector yourself. Refer all servicing to qualified service personnel.
  15. **Damage requiring service**  
Unplug this projector from the wall outlet and refer servicing to qualified service personnel under the following conditions:
    - (a) If the power-supply cord or plug is damaged.
    - (b) If liquid has been spilled, or objects have fallen into the projector.
    - (c) If the projector does not operate normally after you follow the operating instructions. Adjust only those controls that are covered by the operating instructions. An improper adjustment of other controls may result in damage and may often require extensive work by a qualified technician to restore the projector to its normal operation.
    - (d) If the projector has been exposed to rain or water.
    - (e) If the projector has been dropped or the cabinet has been damaged.
    - (f) If the projector exhibits a distinct change in performance - this indicates a need for service.
  16. **Replacement parts**  
When replacement parts are required, be sure that the service technician has used replacement parts specified by the manufacturer or parts having the same characteristics as the original part. Unauthorized substitutions may result in fire, electric shock or other hazards.
  17. **Safety check**  
Upon completion of any service or repair to this projector, ask the service technician to perform safety checks determining that the projector is in a safe operating condition.

**WARNING:****Unplug immediately if there is something wrong with your projector.**

Do not operate if smoke, strange noise or odor comes out of your projector. It might cause fire or electric shock. In this case, unplug immediately and contact your dealer.

**Never remove the cabinet.**

This projector contains high voltage circuitry. An inadvertent contact may result in an electric shock. Except as specifically explained in the Owner's Guide, do not attempt to service this product yourself. Please contact your dealer when you want to fix, adjust or inspect the projector.

**Do not modify this equipment.**

It can lead to fire or electric shock.

**If you break or drop the cabinet.**

Do not keep using this equipment if you break or drop it. Unplug the projector and contact your dealer for inspection. It may lead to fire if you keep using the equipment.

**Do not face a lens to the sun.**

It can lead to fire.

**Use correct voltage.**

If you use incorrect voltage, it can lead to fire.

**Do not place the projector on uneven surface. Level stable surface only.**

Please do not place equipment on unstable surfaces. Do not look into the lens when it is operating. It may hurt your eyes. Never let children look into the lens when it is on.

**Do not turn off the main power abruptly or unplug the projector during operation.**

It can lead to lamp breakage, fire, electric shock or other trouble.

**Place of installation**

For safety sake, refrain from setting the projector at any place subjected to high temperature and high humidity. Please maintain an operating temperature, humidity, and altitude as specified below.

- Operating temperature: between +41°F (+5°C) and +95°F (+35°C)
- Operating humidity: between 30 and 90%
- Never put any heat-producing device under the projector so that the projector does not overheat.
- Do not attach the projector to a place that is unstable or subject to vibration.
- Do not install the projector near any equipment that produces a strong magnetic field. Also refrain from installing near the projector any cable carrying a large current.
- Place the projector on a solid, vibration free surface: otherwise it may fall, causing serious injury to a child or adult, and serious damage to the product.
- Do not stand the projector: it may fall, causing serious injury and damage to the projector.
- Place the projector within a slope of  $\pm 15^\circ$ . Slanting the projector more than  $\pm 15^\circ$  may cause trouble or explosion of the lamp.
- Do not place the projector near air-conditioning unit or heater to avoid hot air to the exhaust and ventilation hole of the projector.

**COMPLIANCE NOTICE OF FCC**

This equipment has been tested and found to comply with the limits for a Class A digital device, pursuant to Part 15 of the FCC Rules. These limits are designed to provide reasonable protection against harmful interference when the equipment is operated in a commercial environment. This equipment generates, uses, and can radiate radio frequency energy and, if not installed and used in accordance with the instruction manual, may cause harmful interference to radio communications. Operation of this equipment in a residential area is likely to cause harmful interference in which case the user will be required to correct the interference at his own expense.

This digital apparatus does not exceed the Class A limits for radio noise emissions from digital apparatus as set out in the interference-causing equipment standard entitled "Digital Apparatus", ICES-003 of the Department of Communications.

Changes or modifications not expressly approved by Mitsubishi could void the user's authority to operate this equipment.

**COMPLIANCE NOTICE OF INDUSTRY CANADA**

This Class [A] digital apparatus meets all requirements of the Canadian Interference-Causing Equipment Regulations.

# Overview of the projector

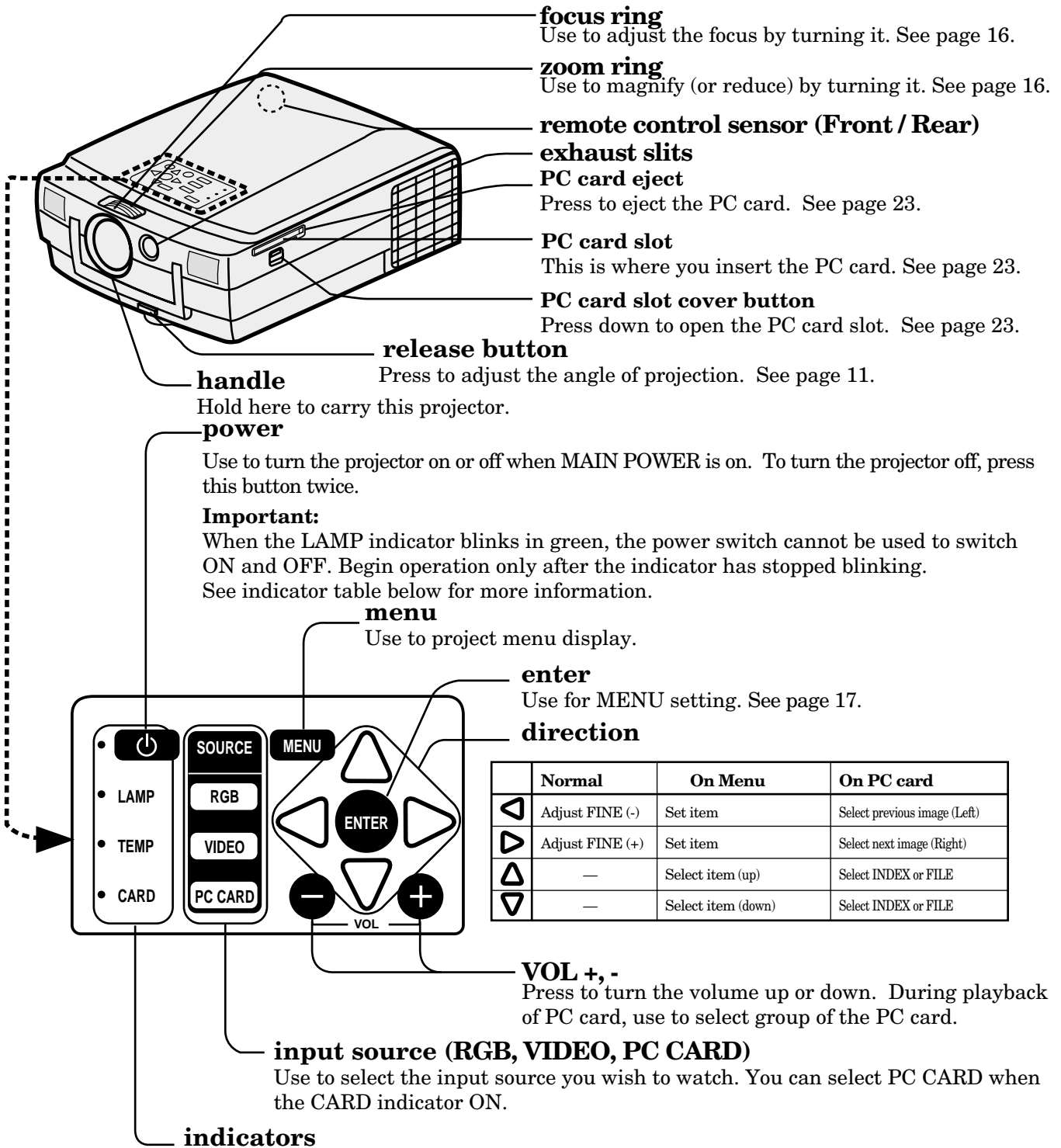

POWER(Ⓞ)	LAMP	TEMP	CARD	Condition
Steady red				Stand-by.
Steady green	Blinking green → Steady green			Power is ON.
Steady green	Steady green	Blinking red		Abnormal temperature warning (high temperature).*1
Steady red		Steady red		Abnormal temperature-OVER (high temperature). The source lamp will be also turned off.
Steady green	Blinking red/green			Lamp duration warning. (Lightning duration total about 1,500 hours.) *2
Steady red	Steady red			Lamp duration-OVER. (Lightning duration total about 2,000 hours.)
Steady green	Steady green		Steady green	PC card inserted, off then no PC card.

\*1 : In the condition, the sign of TEMP!! blinks red on the screen.

\*2 : When the lamp has been used for about 1,900 hours, the message LAMP!! will appear on the screen.

## Left side

### MAIN power

I : ON  
O : OFF

### power jack

See page 11.

### line output (stereo mini jack)

Use to output PC audio if PC line in, or Audio input is connected.

### PC analog RGB output (mini D-SUB 15P)

Use to output RGB signal from RGB input. See pages 12 - 14.

### PC analog RGB input (mini D-SUB 15P)

Use to input RGB signal for PC or component signal for DVD etc. See pages 12 - 14.

### line input (stereo mini jack)

Use to input PC audio signals. See pages 13, 14.

### RS-232 input (Mini DIN 8P)

Use to connect with personal computer when using the remote control as mouse, or control the projector with the personal computer.

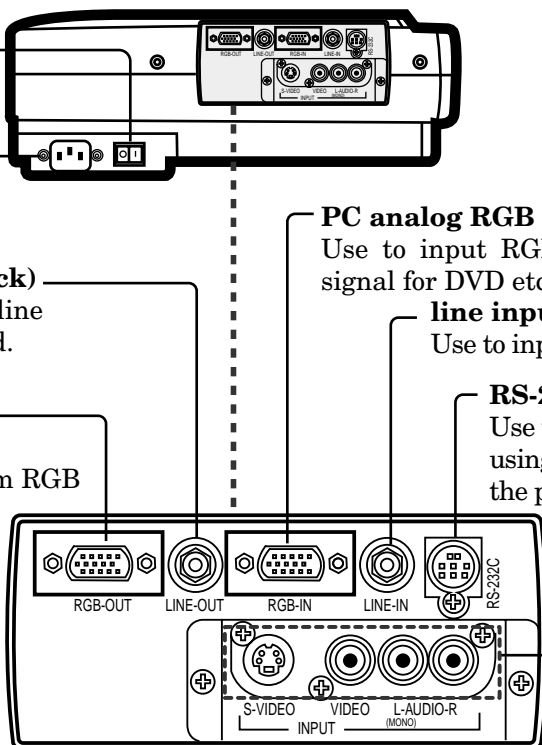

### video/audio input

Use to input video and audio. See page 12.

### PC analog RGB input

Use to input video signals (analog RGB) of a personal computer.

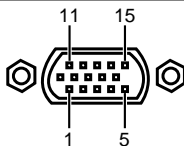

(Pin assignment of Mini D-SUB 15P jack)

PIN NO.	SPEC	PIN NO.	SPEC
1	R(RED)/C <sub>R</sub>	9	—
2	G(GREEN)/Y	10	GROUND
3	B(BLUE)/C <sub>B</sub>	11	GROUND
4	GROUND	12	—
5	GROUND	13	HD/CS
6	GROUND	14	VD
7	GROUND	15	—
8	GROUND		

### RS-232C input

Use to control the projector with the personal computer, or control the personal computer with remote control. Use the provided RS-232C cable (Mini DIN 8P– D-SUB 9P) for the connection.

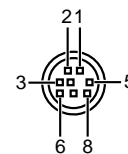

PIN NO.	NAME	I/O
1	TXD	IN
2	RTS	IN
3	DTR	IN
4	GND	—
5	CTS/5V	IN/OUT
6	DCD/CLOCK	OUT
7	RXD	OUT
8	RI/DATA	OUT

## Bottom side

### lamp lid

Caution:

Do not replace the lamp right after using the projector. The lamp is very hot.

Front

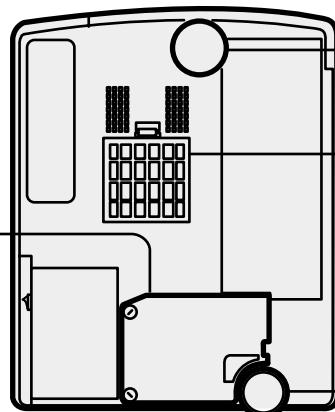

adjustment foot (up and down)

filter cover

adjustment foot (right and left)

# Overview of the remote control

The buttons with \*mark work as same as the buttons on the projector.

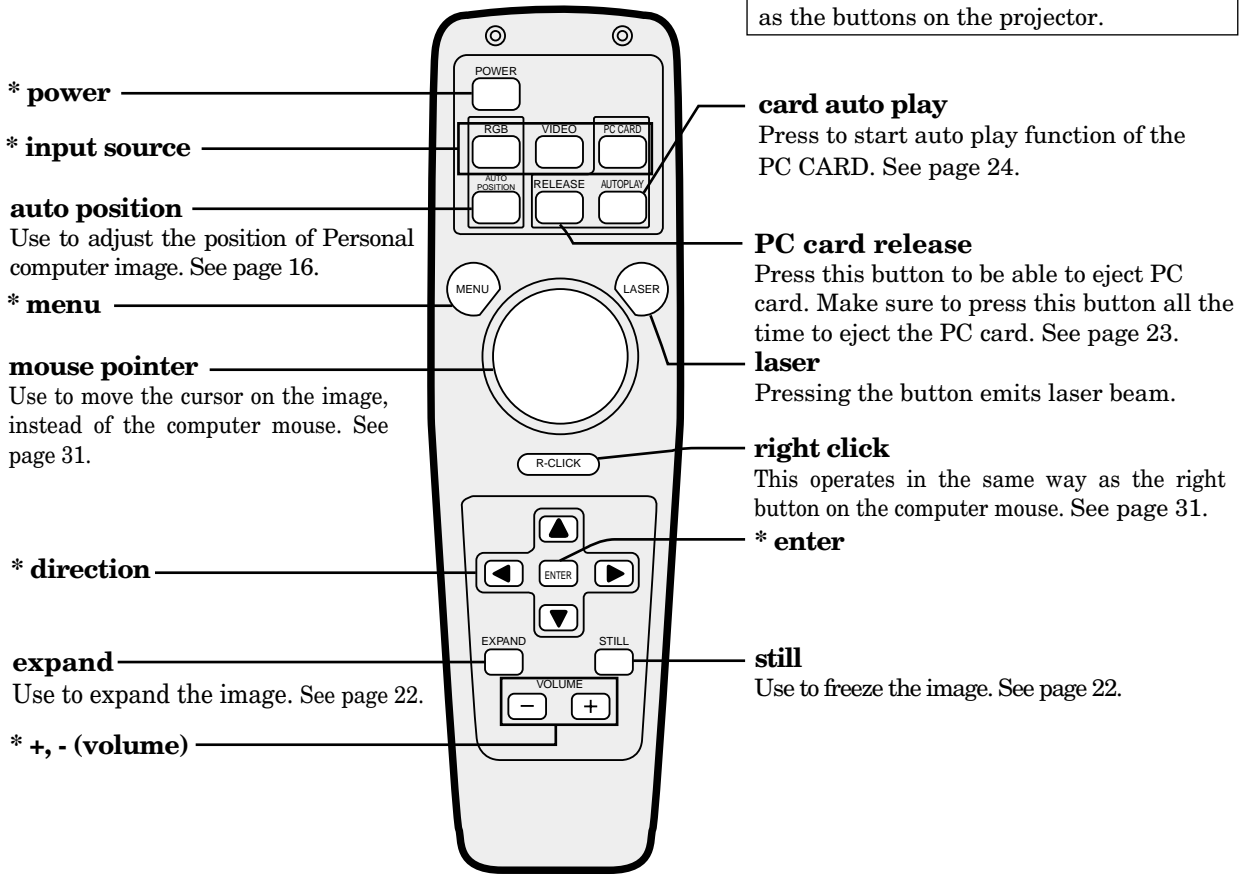

**left click**  
This operates in the same way as the left button on the computer mouse. See page 31.

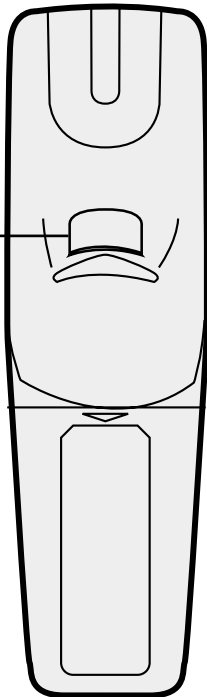

## About laser beam

This remote control is the class 2 (max. output 1mW laser diode 645nm) laser equipment.

CAUTION

LASER RADIATION  
DO NOT STARE INTO BEAM

---

WAVE LENGTH : 645nm  
MAX OUTPUT : 1mW  
**CLASS II LASER PRODUCT**

### CAUTION :

Pressing the LASER button provided remote control emits laser beam. Do not look into the beam light directly. Do not point the laser beam to people. Looking the laser beam directly may lose eyesight.



## Battery installation

Use two AA size batteries.

1. Remove the back cover of the remote control by pushing the battery compartment door in the direction of the arrow.
2. Load the batteries making sure that they are positioned correctly (+ to +, and - to -).
3. Replace the back cover.

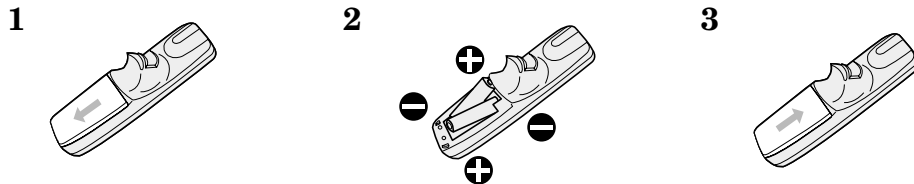

### Important:

- Do not use a new battery with an old one.
- Load batteries in the correct position.
- Do not heat, take apart, or throw batteries into fire.
- Do not try to recharge batteries. Do not use rechargeable batteries.
- If the alkaline solution of alkaline batteries comes in contact with your skin or clothes, rinse with water. If the solution comes in contact with your eyes, rinse them with water and then consult your doctor.

## Operation area

The range for operation is about 10m when the remote control points to the projector. The distance to the screen back to the projector must be less than 7m. Depending on the type of the screen, the distance is different.

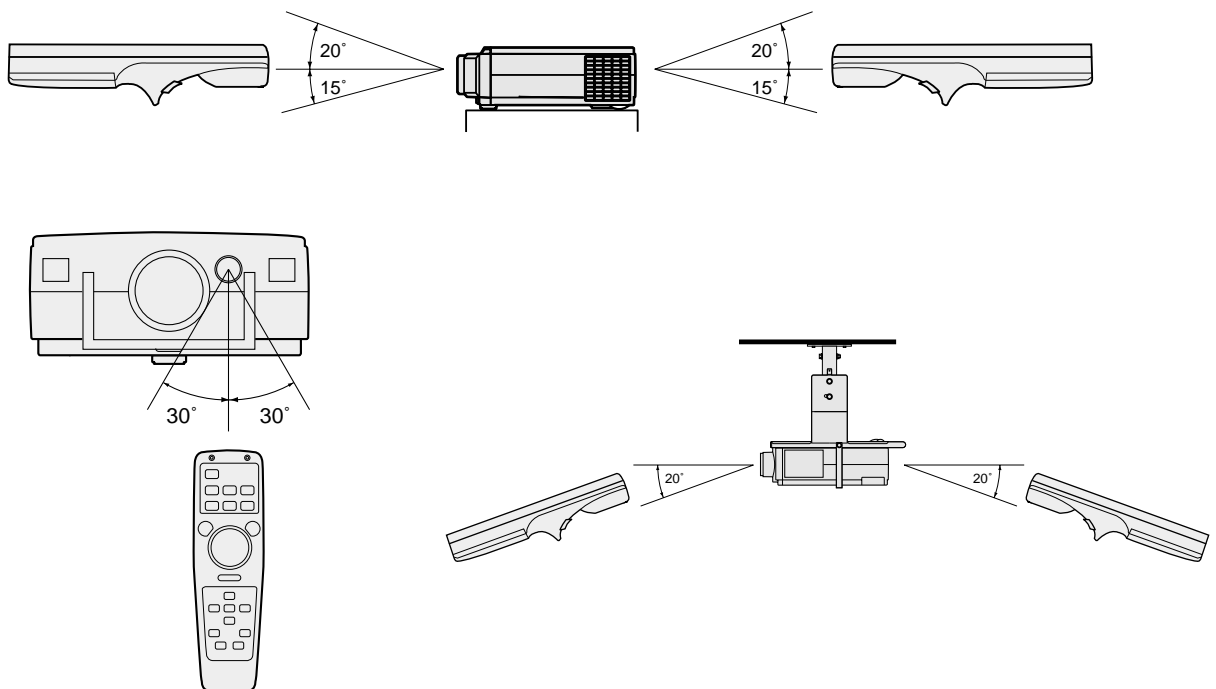

### Important:

Avoid the direct sunlight or fluorescent light to the remote control sensor. Also keep the distance of more than 2 m between the remote control sensor and fluorescent lamp. The remote control may not work correctly.

# Preparing the projector for operation

## Orientation of the projector

Picture size can be set by changing the distance between the screen and the projector.

### Front projection

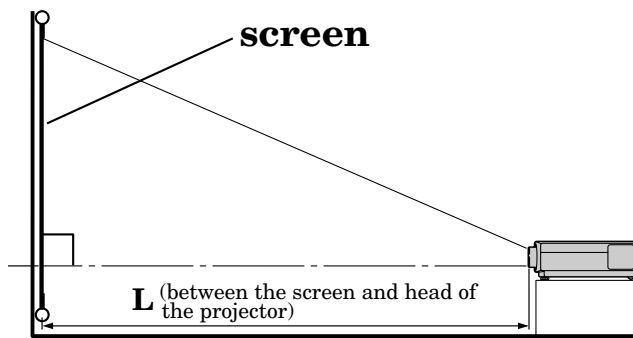

To find the approximate distance between the projector and screen: Multiply the width of the screen  $\times 2.0$  (max.), Multiply the width of the screen  $\times 2.5$  (min.).

- Refer to the chart to recommended distances in maximum zoom and minimum zoom.

Screen			Distance from screen (L) / (approximate)			
Diagonal size (inch)	Height inches (inch)	Width feet (inch)	Maximum zoom (min.)		Minimum zoom (max.)	
			(cm)	(inch)	(cm)	(inch)
23 "	13.8 "	18.4 "	–	–	112	44.1 "
40 "	24 "	32 "	155	61.0 "	201	79.1 "
60 "	36 "	48 "	236	92.9 "	305	120 "
80 "	48 "	64 "	317	125 "	410	161 "
100 "	60 "	80 "	399	157 "	513	202 "
150 "	90 "	120 "	602	237 "	774	305 "
200 "	120 "	160 "	805	317 "	1034	407 "
245 "	147 "	196 "	988	389 "	–	–

- The above numbers are the design numbers, and may be slightly different from the actual numbers.

### Front projection, ceiling mount

For ceiling mount, you need the ceiling mount bracket. For more detail, ask your dealer.

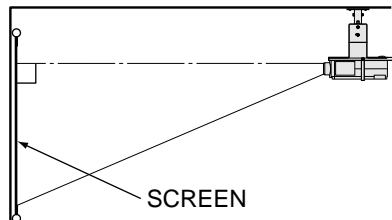

- Projected images may appear darker when the unit is used as a ceiling installation than when it is used in the tabletop position. This does not signify a product malfunction.

### Rear projection

Ask a specialist for installation. For more detail, ask your dealer.

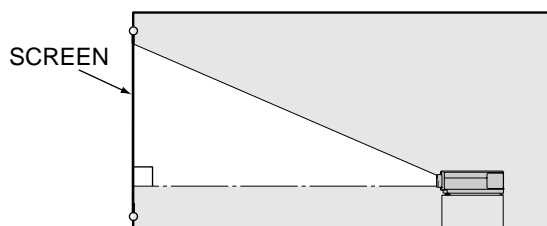

- For rear projection, set IMAGE REVERSE in INSTALLATION menu to MIRROR. See Page 18.

### Caution:

- Placing the projector on a carpet reduces ventilation from the fan on the bottom and might cause problems. Place a hard board or similar item under the projector to facilitate ventilation of the unit.
- Place the projector more than 20 in. from the wall to prevent blocking the intake, exhaust slots and ventilation of this projector because hot air comes out of it.
- Do not use the projector under the following circumstances, which may cause fire or electric shock.
  - in a dusty or humid place
  - while the projector is lying sideways or upside down.
  - near a heater
  - in a kitchen or oily, smoky or damp place
  - in direct sunlight
  - with high temperature, such as the closed car
  - where the temperature is lower than 41°F or higher than 95°F

### Important:

- Do not put stress on the lens or focus ring, as this may damage them.
- Keep your room dark while using the projector. The image cannot be seen clearly in a bright place.

## Adjusting the angle of projection

Screen on a flat wall with a 90 degree angle to the floor by adjusting two Adjustment feet on the bottom of the projector. If the angle cannot be corrected by them, adjust the height and angle of screen.

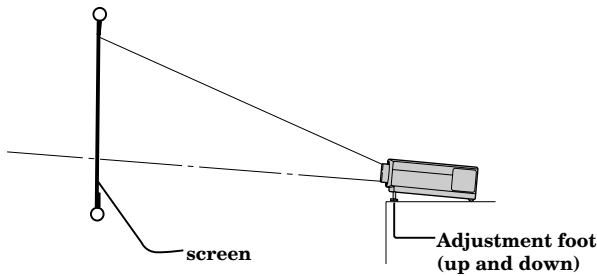

1. Lift the projector to the right angle.
2. Press the release button for angle adjustment to take the Adjustment foot (up and down) out of the projector.
3. Release the button and keep your hands away from the projector.
4. Turn the foot to right or left to adjust for proper angle.

After using the projection,

5. Press the release button to take the projector down slowly with holding it.

### When the left and right angles are different

Adjust the angles with adjustment feet (right and left), which are on the bottom of the projector. When shipping the projector at first, the Adjustment feet are covered with sponge to be parallel on a flat surface. Remove the sponge to adjust the Adjustment feet lower. Do not lose the sponge.

- Screen on a flat wall with a 90° angle to the floor.
- Align projector to produce a full screen display as illustrated on page 10.
- Distance from projector to screen must be compatible with screen size chart on page 10. Note distance from screen chart.

## Getting ready for projection

1. Connect the power cord provided to the projector.
2. Connect the power cord to the wall outlet.

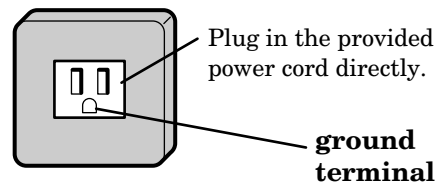

3. Take off the lens cap.

### Warning:

- Do not look directly into the lens when projector is "ON".
- The lens cap is for protecting the lens. If you leave the power on with the cap on, the cap may be warped. Please remove the lens cap when you turn the power on.
- A three-pin grounding type power plug is used with the projector. Do not remove the grounding pin on the power plug. If you are unable to insert the plug into the outlet, contact your electrician to replace your A/C obsolete outlet.
- The supplied power cord is used for 120V only. Never connect to any outlet or power supply having a different voltage or frequency. If you connect to the power supply having a different voltage, please use the appropriate power cord.
- Do not place an object on the power cord and keep the projector away from heat source to avoid breaking the power cord. A broken power cord can cause fire or electric shock.
- Do not revise or alter the power cord otherwise it may cause fire or electric shock. Contact your dealer if the cord is broken.

### Caution:

- Plug in firmly and unplug by holding the plug, not by pulling the cable out.
- Do not plug in or out with wet hands. It may cause an electric shock.

# Basic connections

This projector can be connected to equipment such as VCRs, video cameras, videodisc players, and personal computers having analog RGB input.

## Important:

- Make sure that your equipment is turned off before connection.
- Match the color of video and audio plugs on the AV cable with each terminal.
- Plug in firmly and unplug by holding the plug, not by pulling the cable out.
- If connected units are set too close to one another, the image may be affected.
- Refer to the owner's guide of each component for details of connections.

## Projector + AV equipment

Make sure that your equipment is turned off before connection.

## Important:

S-video signals take priority over video signals. If you input both S-video signals and normal video signals at the same time, the normal video input automatically is inhibited.

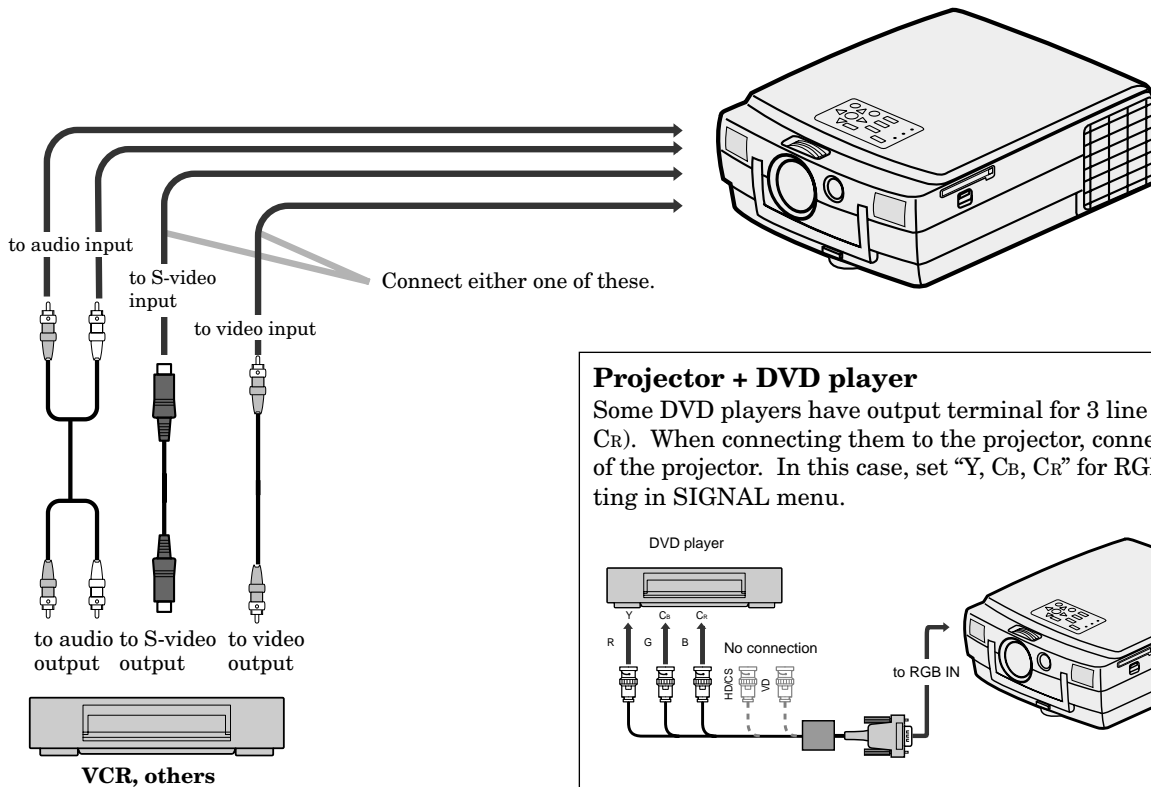

## Cables and adapters

To connect personal computers to this projector, the following cables and adapters are necessary. The overview might be different from the picture below.

### RGB cable for PC (mini D-SUB 15P plug)

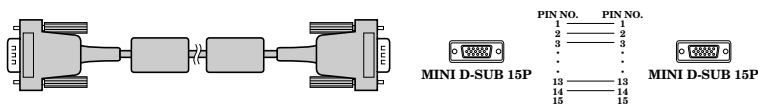

Note: The pins numbered 9, 12 and 15 are not connected.

### MAC adapter for RGB cable

(mini D-SUB 15P plug - D-SUB 15P plug)

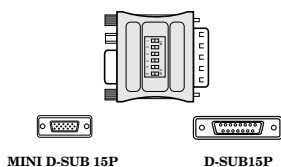

Note: Set the dip switch to the appropriate position.

Display mode	Resolution	Dip switch					
		1	2	3	4	5	6
13 inch	640 × 480	ON	ON	OFF	OFF	OFF	OFF
<b>16 inch</b>	<b>832 × 624</b>	OFF	ON	OFF	ON	OFF	OFF
19 inch	1024 × 768	OFF	ON	ON	OFF	OFF	OFF
21 inch	1152 × 870	ON	ON	ON	ON	OFF	OFF

## Projector + IBM PC or IBM PC compatibles

Make sure that your equipment is turned off before connection.

### Important:

- Connectors or analog RGB output adapters may be necessary depending on the personal computer connected to this projector. Please contact your dealer.
- The audio input for a personal computer is the stereo mini-jack. There are some personal computers that have different types of audio outputs or none at all. Please ask your dealer for details.
- For connection details, refer to the owner's guide of each component.

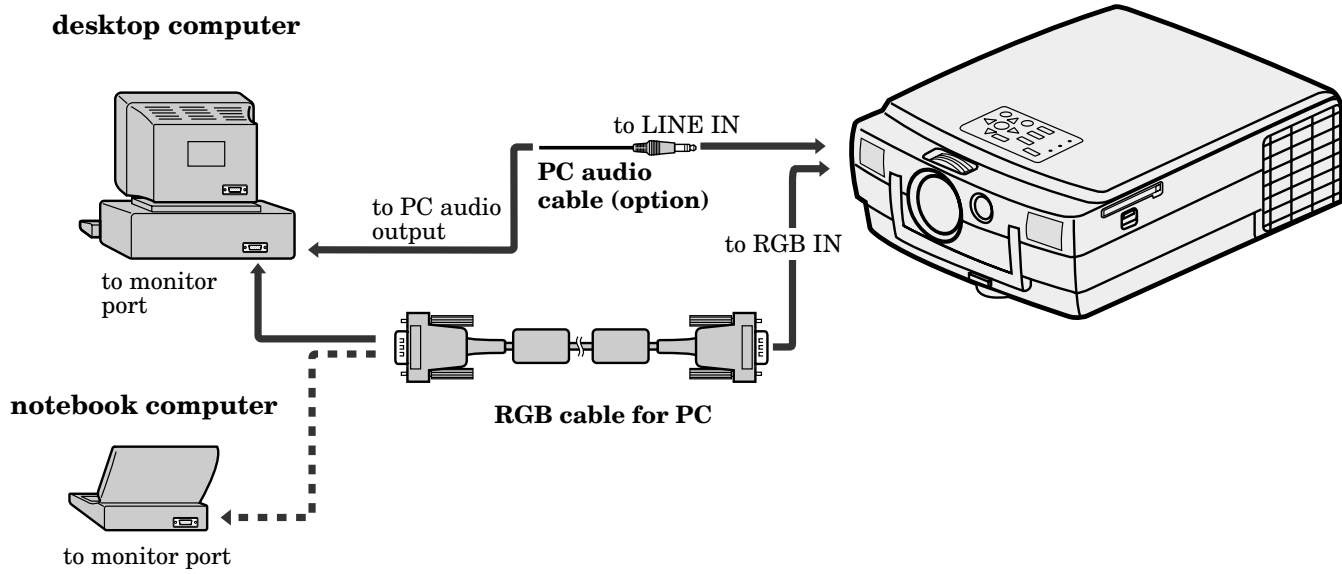

### When outputting to both a PC monitor and the projector

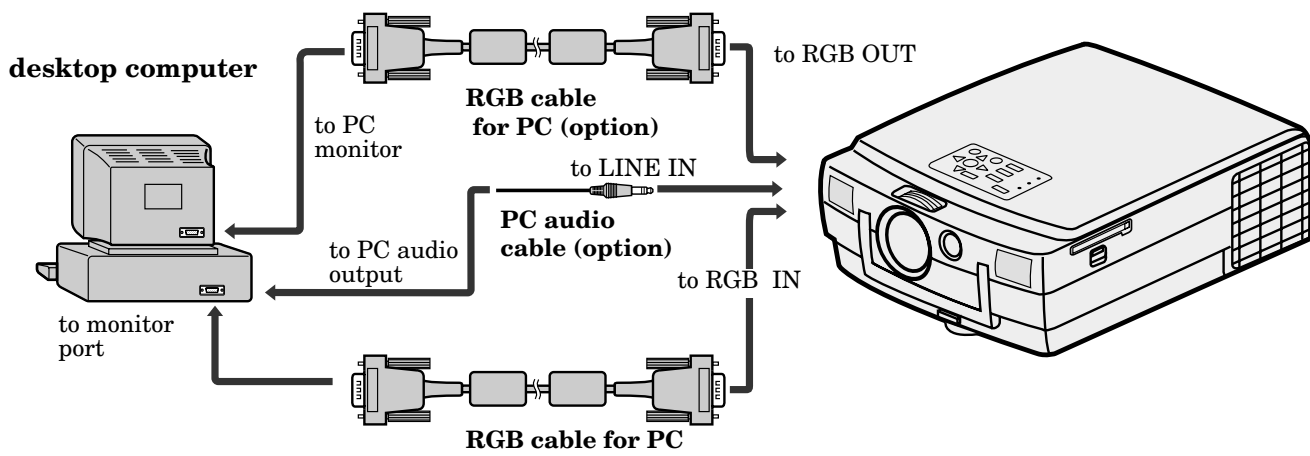

## Basic connections (continue)

### Projector + Macintosh

Make sure that your equipment is turned off before connection.

#### Important:

- A monitor output adapter is necessary for a Macintosh if it has no video port. Please contact your dealer.
- If you use the MAC adapter for RGB cable provided, set the dip switch to the appropriate position. See page 12.
- Connectors or analog RGB output adapters may be necessary depending on the personal computer connected to this projector. Please contact your dealer.
- The audio input for a personal computer is the stereo mini jack. There are some personal computers that have different types of audio outputs or none at all. Please ask your dealer for details.
- For connection details, refer to the owner's guide for each component.
- When outputting to both a PC monitor and the projector, use an Apple Macintosh monitor or multiscan monitor corresponding to Composite Sync.

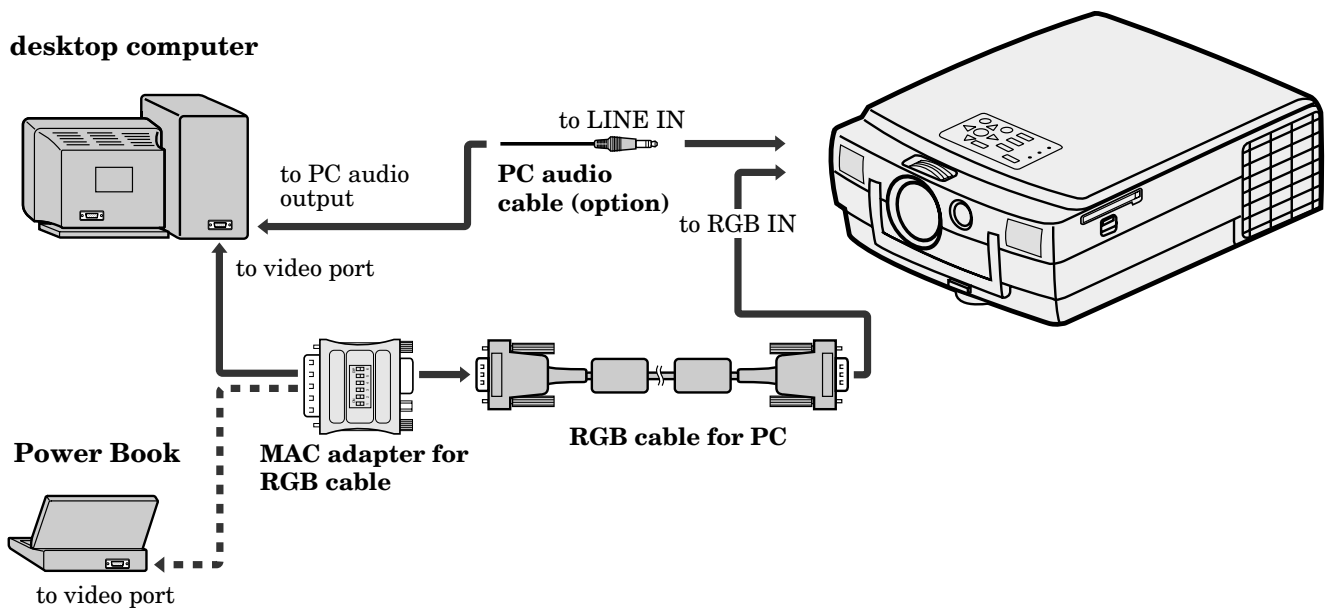

#### When outputting to both a PC monitor and the projector

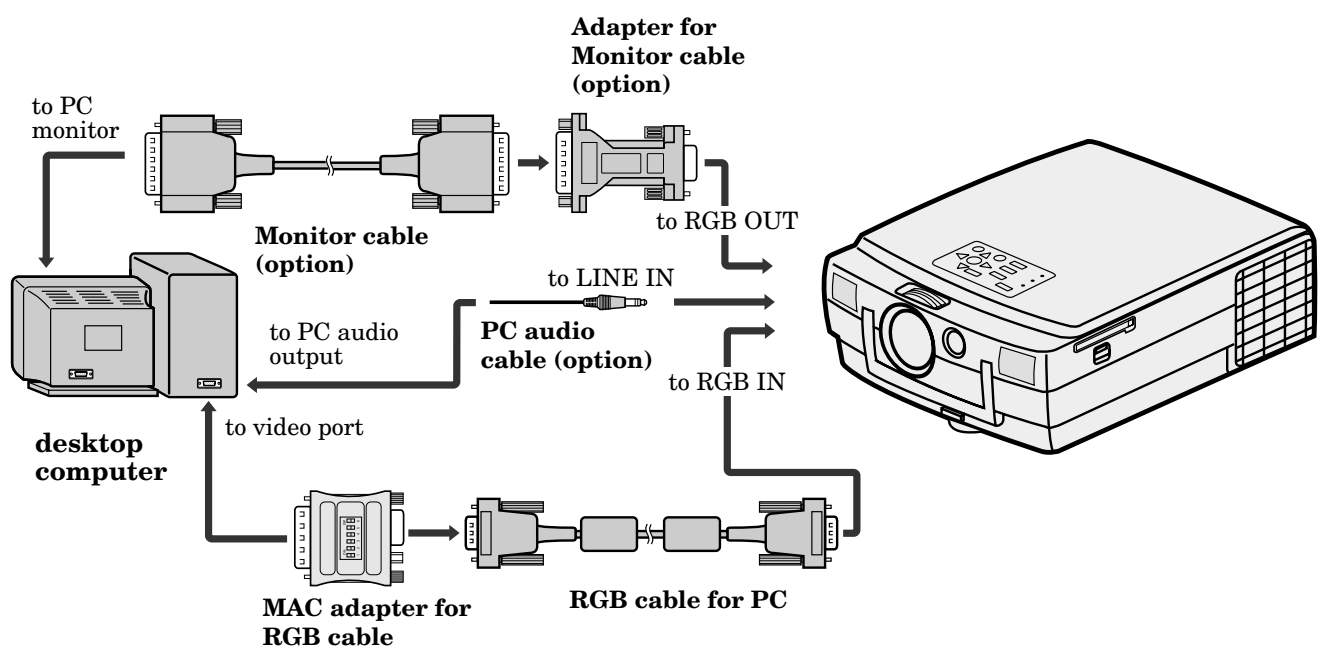

# To operate projector power ON

Numbers 1 - 9 correspond to the instruction numbers below.

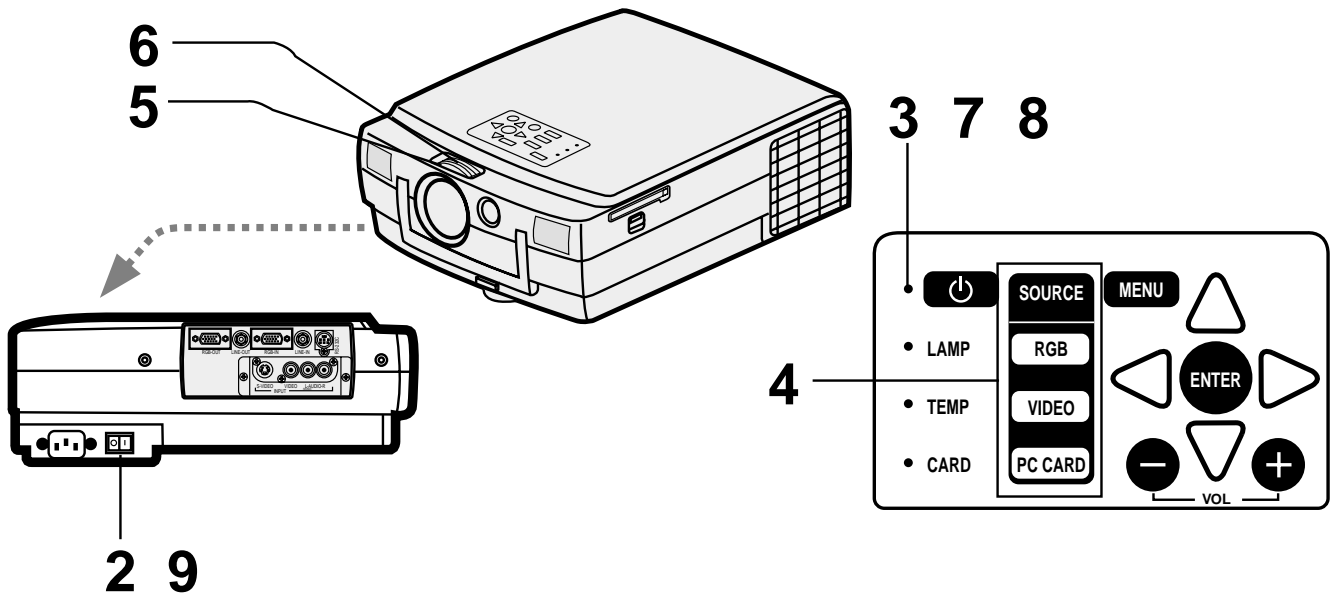

1. Turn on the equipment connected to the projector.
2. Put the projector into standby mode by pressing the main power switch. The POWER indicator lights up red.
3. Turn the projector on by pressing the POWER button.  
The light source lamp starts warming up, eventually turn on. In cases where light source lamp does not come on, wait for one minute before switching power on again.
  - If the main power switch to the unit is turned off within two minutes of turning off the light source lamp, power will not be applied to the lamp for one minute the next time the main unit power switch is turned on. When this happens, the indicator lamp will blink for one minute.

condition	indicator	LAMP	POWER
stand-by		-	red
when light source lamp is on		green	green
when light source lamp does not light up		-	red

### Important:

- A darkened image may be seen right after pressing the POWER button due to warming up of this projector. While warming up, no other commands can be accepted.
  - When the lamp indicator is blinking red, the service life of the lamp is about to end. Replace the lamp. See pages 32 and 36.
  - The picture might not be of optimum performance in extreme hot or cold conditions. (The projector is not malfunctioning.)
4. Select the desired external input source by using the RGB or VIDEO button.
    - The projector automatically selects the appropriate signal format. The selected signal format is displayed on the SIGNAL menu.
    - When selecting the RGB input, the image may flicker. Press the ◀ or ▶ button to adjust the image.
    - Press the PC CARD button to see the PC CARD images. (You cannot select it when CARD indicator is not lighting up.)

## To operate projector power ON (continue)

### AUTO POSITION button

When the source is selected to RGB and the image is not in the right place, set to display as bright signal as possible, then press the AUTO POSITION button on the remote control. If the image is still not in the right place.

- Set screen to the brightest display as possible (e.g., full-screen display of the “Trash” window) before deploying the automatic adjustment function.
  - If the screen saver is running, turn off the screen saver before using the automatic adjustment button.
5. Adjust the focus with the focus ring by turning it.
  6. Adjust the image size with the zoom ring by turning it.

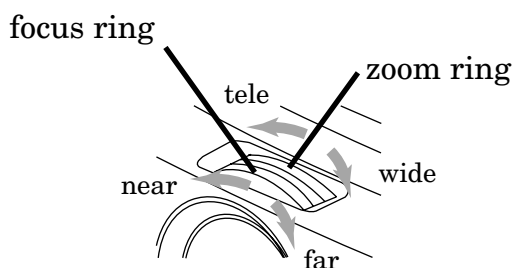

### The volume from the speaker

Press the volume + or – button to change the volume from the speaker.



- The volume buttons do not work when MENU selection bar or MENU is displayed.
- The volume buttons do not work when the source is selected to PC CARD.

### Turning off the projector

7. Press the POWER button.  
The message “POWER OFF? YES : PRESS AGAIN” appears on the screen.
  - To exit from this mode, press any button except POWER, LASER, mouse pointer, R/L-click, STILL and VOLUME + and - button.
8. Press the POWER button again.  
The light source lamp will be turned off.  
Pressing the POWER button again will shut off the light source lamp, but the exhaust fan continues to operate for 120 seconds to cool down the light source lamp and LCD panels. In this time, the lamp indicator will be turned off from flashing.
9. Turn off the main power switch. When turning off the main switch, the POWER indicator turns off.

- In cases where the main power switch is accidentally turned off when either the intake/exhaust fan or the power source lamp is in operation, allow the unit to cool down for 10 minutes with the power turned off. Repeat step 3 when turning on the power source lamp. If the lamp does not turn on immediately, repeat this step two or three times. Replace the lamp if it should still fail to turn on.

### Caution:

- When you have finished using this equipment, wait 120 seconds for the exhaust fans to stop. Then turn off the main switch and unplug the power cable from the wall outlet, for safety purposes.
- After the lamp is turned off, the lamp cannot be switched on again for 60 seconds as a precautionary measure. It will take another 60 seconds before the lamp indicator goes off. If you wish to turn on the projector again, wait until the indicator is off then press the POWER button.
- The exhaust fan runs rotate faster automatically when the temperature around the projector becomes high.
- When the temperature around the projector becomes much higher, the sign of “TEMP!!” blinks red on the screen. If the temperature stays in high, the lamp will be shut off automatically .

**The projector automatically shuts off when the lamp is used up in about 2,000 hours and not used until lamp replacement.**



# Menu operation

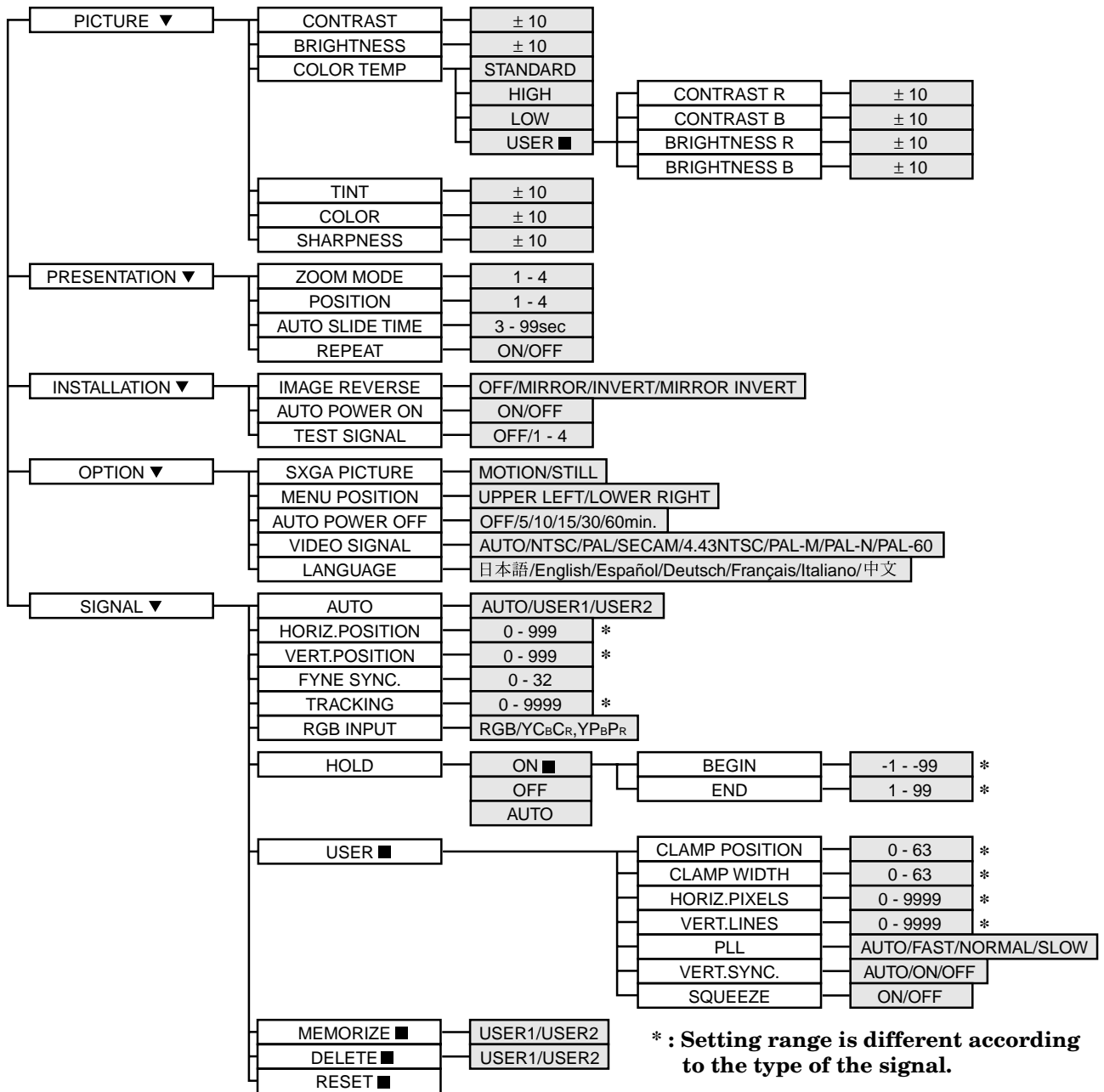

## Basic operation

Several settings can be adjusted using Menu.

EXAMPLE: Auto power off time setting

1. Press the MENU button.



2. Press the ◀ or ▶ button to select OPTION menu.



3. Press the ENTER button (or ▲ or ▼ button).



4. Press the ▲ or ▼ button to select AUTO POWER OFF.



5. Press the ◀ or ▶ button to adjust auto power off time.



6. Exit the menu system by pressing the MENU button several times.

- If the menu operation is not working, simultaneously press the MENU and POWER buttons.
- The input source can not be changed when the MENU selection bar or MENU is displayed.
- The settings with ■ mark, you should press the ENTER button after selecting.

## Menu setting (continue)

### ① PICTURE

- CONTRAST** ..... Adjusts the picture contrast. The contrast becomes higher as the number increases.
- BRIGHTNESS** .... Adjusts image brightness. The image becomes brighter as the number increases.
- COLOR TEMP** .... Adjusts color temperature.
- TINT** ..... Adjusts the color balance in the image. The color balance of the image shifts green as the number increases and shifts to purple as the number decreases (only when NTSC or 4.43 NTSC is selected).
- COLOR** ..... Adjusts the color intensity of the image (only when the source is selected to VIDEO).
- SHARPNESS** ..... Adjusts the picture sharpness. The sharpness becomes sharper as the number increases (only when the source is selected to VIDEO).



### ② PRESENTATION

This menu appears when either the display enlargement and PC card play functions are used.

- ZOOM MODE** ..... Selects the desired type of expand mode, type1, 2, 3 or 4 (Actual size display).
- POSITION** ..... Selects the desired position of the sub image in expand mode.
- AUTO SLIDE**
- TIME** ..... Sets the length of time before the image switches to the next image in PC CARD automatic playback mode.
- REPEAT** ..... Sets to repeatedly playback the PC CARD presentation.

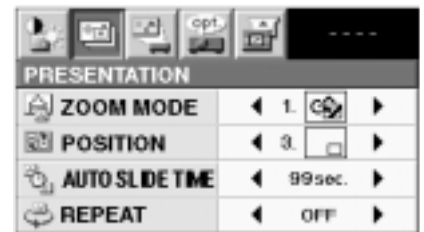

### ③ INSTALLATION

- IMAGE REVERSE** Use to reverse or invert the projected image. MIRROR is used for rear projection. MIRROR INVERT is effective when the projector is ceiling-mounted.
- AUTO POWER ON** .... To select whether to boot up automatically when the power is turned on by a breaker. In this case, the main power of the projector has to be ON. Set this when the projector is hanging on the ceiling.
- The projector is in stand-by mode when the lamp does not come on. In this case, use the remote control to turn on the lamp.
- TEST SIGNAL** .... Use to display the built-in test patterns on the screen.
- The display will disappear when the setting is OFF or press the button except MENU, ▲, ▼, STILL, LASER, mouse pointer and R/L-click.



### ④ OPTION

- SXGA PICTURE** . Select MOTION when motion images are mainly projected. Select STILL when still images such as PC-CARD images are mainly projected. It works only when inputting personal computers of SXGA signals or inputting video signal.
- MENU POSITION** . Use to select the position where the menu is displayed (upper left or lower right on the screen).
- AUTO POWER OFF** .. Use to select the length of time the projector switches to standby when there is no input signal selected source. Select OFF to cancel this function.
- VIDEO SIGNAL** . When AUTO is set, the appropriate video format is automatically selected according to the input signal. If the image does not appear correctly, select the desired video format manually. Adjust the unit to the appropriate format when the unit either is not projecting normally in auto mode or is inputting PAL-M/PAL-N signals.
- LANGUAGE** ..... Use to select the language for the projector display such as menu. (日本語/ English / Español / Deutsch / Français / Italiano /中文)

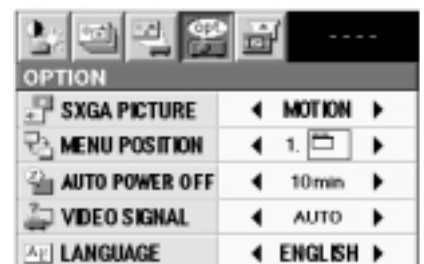

⑤ **SIGNAL**

- AUTO ..... Use to select AUTO, USER 1 or USER 2.
- HORIZ. POSITION .... Use to adjust the horizontal position of the image.
- VERT. POSITION ..... Use to adjust the vertical position of the image.
- FINE SYNC. .... Use to synchronize the projector with PC input signals so that the image is not blurred.
- TRACKING ..... Use to avoid image noise such as wide stripes.
- RGB INPUT ..... The unit adjusts itself automatically when connected to either DVD players with a component video output terminal (Y, C<sub>B</sub>, C<sub>R</sub> or Y, P<sub>B</sub>, P<sub>R</sub>) or equipment with HDTV signal output capabilities. In cases where the unit is connected to equipment that include an RGB output terminal and which output HDTV signals, adjust the unit to RGB mode.
- HOLD ..... Adjusts the image which upper side is awry.

SIGNAL	
AUTO	◀ AUTO ▶
HORIZ POSITION	◀ 333 ▶
VERT. POSITION	◀ 333 ▶
FINE SYNC.	◀ 16 ▶
TRACKING	◀ 3333 ▶
RGB INPUT	◀ RGB ▶
HOLD	◀ AUTO ▶
USER MEMORIZE DELETE RESET	

⑥ **SIGNAL - USER** (Normally, there is no need for adjustments.)

- CLAMP POSITION/  
CLAMP WIDTH ..... If you use a PC video card or something similar, the brighter colors of the projected image may become blurred. In this case, adjust CLAMP POSITION or CLAMP WIDTH.
- HORIZ. PIXELS .... Use to adjust the width of the image. The image size grows wider as the number increases. (Adjust to the horizontal pixels of inputting signal for normal setting.)
- VERT. LINES ..... Use to adjust the height of the image. The image size grows higher as the number increases. (Adjust to the vertical lines of inputting signal for normal setting.)
- PLL ..... Use to adjust the image which upper side is awry. Select AUTO for normal setting.
- VERT. SYNC. .... Use to adjust the image when its motion does not run naturally. Select AUTO for normal setting.
- SQUEEZE ..... Set to ON when displaying DVD discs which are recorded as the squeezed image (in right and left direction).

SIGNAL-USER	
CLAMP POSITION	◀ 33 ▶
CLAMP WIDTH	◀ 33 ▶
HORIZ PIXELS	◀ 3333 ▶
VERT. LINES	◀ 3333 ▶
PLL	◀ AUTO ▶
VERT. SYNC.	◀ AUTO ▶
SQUEEZE	◀ ON ▶

# Picture adjustment

## Adjustment from personal computer

Although this projector sets proper signal settings set automatically for the image signal from personal computers. But, at times, there can be some differences in timings. In this case, press AUTO POSITION button. If the images are still not projected correctly, use MENU display to adjust the projected images from personal computers. After adjustments are made, the new settings can be saved in user function.

## Adjusting the images from personal computers in MENU display

Adjust as below for the following symptoms.



### Image moves to right or left :

Adjust HORIZ. POSITION in SIGNAL menu. Press the ▶ button to move the image to left. Press the ◀ button to move the image to right.

### Image moves to up or down :

Adjust VERT. POSITION in SIGNAL menu. Press the ▶ button to move the image to upward. Press the ◀ button to move the image to down.

### Image flickers / Image is out of focus :

Adjust FINE SYNC. in SIGNAL menu.

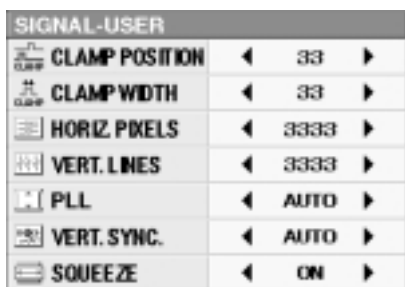

### Wide stripes appear :

Adjust CLAMP POSITION or CLAMP WIDTH of each menu in SIGNAL - USER menu.

### Noise etc. appears on right or left side of image:

Adjust HORIZ. PIXELS of the menu in SIGNAL - USER menu.

### Noise etc. appears on top or bottom part of image :

Adjust VERT. LINES of the menu in SIGNAL - USER menu.

### Top part of image curves :

Change the setting of HOLD in SIGNAL menu or PLL in SIGNAL - USER menu.

HOLD ... Select ON, and adjust BEGIN or END for image which top part is the least curved.  
PLL ..... Select FAST, NORMAL, or SLOW for image which top part is the least curved.  
Select AUTO for normal setting.

### Image does not move naturally :

Adjust VERT. SYNC. of the menu in SIGNAL - USER menu. Select AUTO for normal setting.

- Do not change each menu setting in SIGNAL - USER menu for normal setting.

### Memorizing the setting

1. Select MEMORIZE in SIGNAL menu, and press the ENTER button.
2. Press the ◀ or ▶ button to select the memory which you wish to record (USER 1 or USER 2).
3. Press ENTER button.

### Initializing the setting which has been changed

Select RESET in SIGNAL menu, and press ENTER button.

- When initializing, selection buttons will not work for about 2 - 18 seconds.

### Seeing images in recorded setting.

Select AUTO in SIGNAL menu, and press the ◀ or ▶ button to select the memory (USER1 or USER2).

### Resetting the recorded setting

1. Select DELETE in SIGNAL menu, and press ENTER button.
2. Press the ◀ or ▶ button to select the memory which you wish to reset (USER 1 or USER 2).
3. Press ENTER button  
The recorded setting will be reset.

### The simple way of adjustment

1. Select HORIZ. POSITION in SIGNAL menu.
2. Press the ◀ or ▶ button to adjust the horizontal start position (the left end).
3. Select TRACKING in SIGNAL menu.
4. Press the ◀ or ▶ button to adjust the horizontal end position (the right end).
5. Repeat steps 1 to 4 for fine adjustment.
6. Select VERT. POSITION in SIGNAL menu.
7. Press the ◀ or ▶ button to adjust the vertical start position (the top end).

## Specification of RGB signals in each computer mode of the projector

Signal mode	resolution (H x V)	horizontal frequency (kHz)	Vertical frequency (Hz)	Normal (H x V)	Native (H x V)
TV60	–	15.73	59.94	800 x 600	–
TV50	–	15.63	50.00	800 x 600	–
HiVision	–	33.75	60.00	800 x 450	–
PC98	640 x 400	24.82	56.42	800 x 500	640 x 400
CGA70	640 x 400	31.47	70.09	800 x 500	640 x 400
CGA84	640 x 400	37.86	84.13	800 x 500	640 x 400
CGA85	640 x 400	37.86	85.08	800 x 500	640 x 400
VGA60	640 x 480	31.47	59.94	800 x 600	640 x 480
VGA72	640 x 480	37.86	72.81	800 x 600	640 x 480
VGA75	640 x 480	37.50	75.00	800 x 600	640 x 480
VGA85	640 x 480	43.27	85.01	800 x 600	640 x 480
SVGA56	800 x 600	35.16	56.25	800 x 600	800 x 600
SVGA60	800 x 600	37.88	60.32	800 x 600	800 x 600
SVGA72	800 x 600	48.08	72.19	800 x 600	800 x 600
SVGA75	800 x 600	46.88	75.00	800 x 600	800 x 600
SVGA85	800 x 600	53.67	85.06	800 x 600	800 x 600
XGA43i	1024 x 768	35.52	86.96	800 x 600	1024 x 768
XGA60	1024 x 768	48.36	60.00	800 x 600	1024 x 768
XGA70	1024 x 768	56.48	70.07	800 x 600	1024 x 768
XGA75	1024 x 768	60.02	75.03	800 x 600	1024 x 768
XGA85	1024 x 768	68.68	85.00	800 x 600	1024 x 768
SXGA70a	1152 x 864	63.85	70.01	800 x 600	1024 x 768
SXGA75a	1152 x 864	67.50	75.00	800 x 600	1024 x 768
SXGA85a	1152 x 864	77.49	85.06	800 x 600	1024 x 768
SXGA60a	1280 x 960	60.00	60.00	800 x 600	1024 x 768
SXGA75a	1280 x 960	75.00	75.00	800 x 600	1024 x 768
SXGA43i	1280 x 1024	46.43	86.87	768 x 600	1024 x 768
SXGA60	1280 x 1024	63.98	60.02	768 x 600	1024 x 768
SXGA75	1280 x 1024	79.98	75.03	768 x 600	1024 x 768
MAC13	640 x 480	35.00	66.67	800 x 600	640 x 480
MAC16	832 x 624	49.72	74.55	800 x 600	832 x 624
MAC19	1024 x 768	60.24	75.02	800 x 600	1024 x 768
MAC21	1152 x 870	68.59	74.96	800 x 600	1024 x 768
HP75	1024 x 768	62.94	74.92	800 x 600	1024 x 768
HP72	1280 x 1024	78.13	72.00	768 x 600	1024 x 768
SUN66a	1152 x 900	61.85	66.00	768 x 600	1024 x 768
SUN76a	1152 x 900	71.81	76.63	768 x 600	1024 x 768
SUN66	1280 x 1024	71.68	66.68	768 x 600	1024 x 768
SUN76	1280 x 1024	81.13	76.11	768 x 600	1024 x 768
SGI72	1280 x 1024	76.92	72.30	768 x 600	1024 x 768
SGI76	1280 x 1024	82.00	76.00	768 x 600	1024 x 768
IBM60	1280 x 1024	63.42	60.00	768 x 600	1024 x 768

- When the ZOOM MODE of PRESENTATION menu is set to 4, by pressing the EXPAND button on the remote control, it will switch to the screen displaying the picture as its original size (real screen display). In the real screen display, pictures will be black-framed when picture resolution is lower than 800 X 600.
- If the resolution and frequency of your computer are not shown on the table., change the resolution of your computer. You may find the compatible resolution and frequency.
- Set the RGB/Y, C<sub>B</sub>, C<sub>R</sub> in SIGNAL menu to RGB, when inputting the HDTV signal as RGB signal.

### Important:

- Some computers may not be compatible with the projector.
- The projector's maximum resolution is 800 X 600 pixel. It may not be displayed correctly for the pictures of higher resolutions than 800 X 600.
- The picture with a SYNC on G (Green) signal may jitter.
- The picture with a SYNC on G (Green) signal may be tinged with green.

# Advanced feature for presentation

## Expand

By pressing the EXPAND button on the remote control, you can view the detailed image of the picture.

### Setting the Expand mode

1. Press the MENU button once to display the on-screen menu.
2. Press the ◀ or ▶ button to select PRESENTATION menu.
3. Press the ENTER button.
4. Press the ▲ or ▼ button to select ZOOM MODE or POSITION.
5. Press the ◀ or ▶ button to set the ZOOM MODE or POSITION.
6. Press the MENU button twice to exit the menu system.

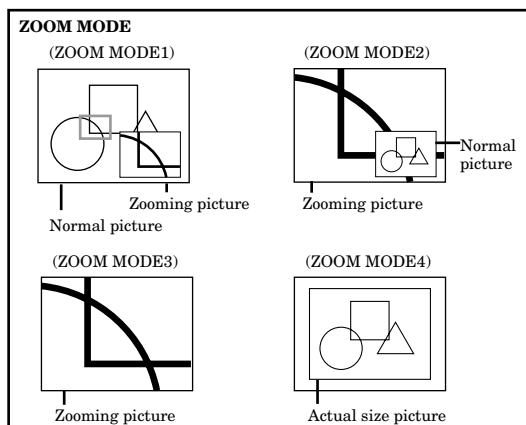

## Using the Expand mode

1. Press the EXPAND button.
  - A red frame indicating EXPAND area will appear.
  - You can magnify different areas of the active picture by pressing the ▲, ▼, ◀ or ▶ button.
  - You can change the magnification of the zoomed area by pressing the + or - button.
2. Press the EXPAND button again.
  - Display enlargement does not work with video input or S-video input.**
  - In EXPAND mode, do not display the test pattern.

### Indication Mode 4 (actual size display)

- Pressing the ◀, ▶ buttons is for adjusting fine adjust.
- The expanding rate cannot be changed either pressing + or - button.

## Still

How to stop the picture temporarily (still picture)

1. Press the STILL button on the remote control.
  - The picture will stop temporarily.

To stop still picture.

2. Press the STILL button on the remote control again.
  - To release the still picture, any buttons also can be used.

# PC-CARD

The projector can play back an image by using the PC-CARD.

## Using the PC-CARD

Use only the flash memory card of PCMCIA•ATA compatible type II.

- Due to PC-CARD type, some images can not be properly recorded. Please contact your dealer.

## Setting up the PC-CARD

1. Set the projector into standby mode by pressing the main power switch. The POWER indicator lights up red.
2. Press down the PC card slot cover button to open the PC card slot cover.
3. Make sure the PC card is going to be inserted in right side. The PC card indicator will illuminate.

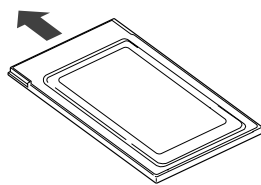

When the input source is set to PC CARD, do not remove the PC card. The projector may not work correctly.

## Removing the PC-CARD

1. Press the RELEASE button on the remote control. PC card eject icon will be displayed on the right end of the screen. The PC card indicator will auto turn off on the projector.
  2. Press down the PC card slot cover button and press the eject button simultaneously.
  3. Remove the PC card from the PC card slot.
- Upon removing a PC card, wait at least 2 seconds before inserting another.
  - The following manufacturer's PC cards have been confirmed to operate within this projector: EPSON, TDK, Logitec, Panasonic, Verbatim, I-O DATA, HAGIWARA, IBM, Mitsubishi (MF-Series).

## Play back

1. Insert the prerecorded PC-card.
2. Press the CARD button. The PC-CARD index display appears on the screen.
3. Press the ◀ or ▶ button to select the desired image.
  - If the PC-CARD is recorded by using the personal computer, select the desired group by pressing the + or - button.
4. Press the ▲ or ▼ button to enter the image display mode.
5. Press the ◀ or ▶ button to display another image.
6. Press the VIDEO or RGB button to quit the PC-CARD playback function.
7. Press the RELEASE button on the remote control.
8. Press the eject button to take the card out.

- **During PC-CARD playback, the sound is switched off.**
- Noise may occur momentarily when images are updated via PC card.
- The images recorded in BMP (not compressed) will take a long time to playback.
- It takes about 10 seconds to playback JPEG compressed data.
- When having an access of PC card as you want to exchange images on PC card, there will be four red line indicated at the edge of the screen.
- If the PC card is ejected when playing back PC card, the image will be switched to VIDEO automatically.
- During PC-CARD playback, if the incorrect display appears, release and re-insert the PC-CARD.

## Playback picture taken by the digital camera

- The image which has been recorded in PCMCIA/ATA card, smart media or compact flash can be played back. The PC card adapter is required to playback smart media and compact flash.
- Depending on the type of the digital camera, the picture may not appear correctly. Please contact your dealer.
- PC card recorded by Digital Camera, the picture will not be displayed on PC-CARD index display.

## PC-CARD (Continue)

To automatically change the image, follow the steps as shown below.

1. Press the MENU button.



2. Press the ◀ or ▶ button to select PRESENTATION.



3. Press the ENTER button.



4. Press the ▲ or ▼ button to select AUTO SLIDE TIME (3 - 99 sec.)

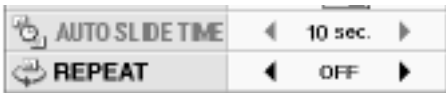

5. Press the ◀ or ▶ button to set the time for auto playback.

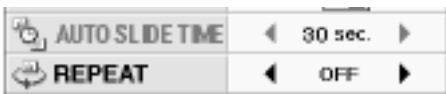

6. Press the ▲ or ▼ button to select REPEAT.



7. Press the ◀ or ▶ button to select ON or OFF.



8. Press the MENU button twice to exit the menu system.

9. Press the PC CARD button.

10. Press the ◀ or ▶ button to select the desired image.

11. Press the AUTO PLAY button on the remote control.

The image automatically changes according your setting.

12. Press the AUTO PLAY button on the remote control to quit the PC-CARD automatic playback function.

- A gray frame will appear during auto play.
- Button operation will only work when the gray frame appears on screen. Button operation is not possible while the red frame is on-screen.
- Auto play can be stopped by pressing the button except LASER, mouse pointer and R/L-click.
- Auto play cannot be used either during image enlargement or when menus are displayed.



# Advanced feature with PC

## PCV (PC Card Viewer)

PC-CARD viewer (PCV) is a utility software that lets you record and project an image to a PC-CARD by using a personal computer.

### Environment

The following system software and hardware are necessary to use the projector.

When you use a Macintosh

- Macintosh series loading 68030 or higher in CPU and a video card with which more than 256 colors are available
- System7.1 or newer
- More than 8MB of Random-access memory (RAM) space

When you use Microsoft® Windows®

- Microsoft® Windows® 95 Operating System (Windows 95) or Microsoft® Windows NT® Operating System Version 4.0 (Windows NT 4.0) or Microsoft® Windows® Operating System Version 3.1 (Windows 3.1) with the CPU loading 80486SX or higher and a display card with more than 256 colors are available.
- 16MB or more of RAM available
- We recommend the following hardware.
  - 32MB or more of RAM available
  - A video display card with full colors are available

### EXPORT LAW ASSURANCES

You acknowledge and agree that the SOFTWARE is subject to restrictions and controls imposed by the United States Export Administration Act (the "Act") and the regulations thereunder. You agree and certify that neither the SOFTWARE nor any direct product thereof is being or will be acquired, shipped, transferred or reexported, directly or indirectly, into any country prohibited by the Act and the regulations thereunder or will be used for any purpose prohibited by the same.

### LIMITATIONS OF REMEDIES

Regardless of whether any remedy set forth herein fails of its essential purpose, in no event will Mitsubishi be liable to you for any special, consequential, indirect or similar damages, including any lost profits or lost data arising out of the use or inability to use the SOFTWARE or any data supplied therewith even if Mitsubishi or anyone else has been advised of the possibility of such damages, or for any claim by any other party.

Some states do not allow the limitation or exclusion of liability for incidental or consequential damages so the above limitation or exclusion may not apply to you.

In no case shall Mitsubishi's liability exceed the price for the SOFTWARE.

## Installation of software

For Windows 95 or Windows NT 4.0

1. Start up Windows.
  2. Insert the Projector driver CD-ROM into your CD-ROM drive.
  3. Start up Program Manager.  
Click the [Start] button and select the [Run (R)] command. Then the [Run] dialog box is displayed.
  4. If you inserted the CD-ROM to drive D, type [D: Win95\Pcv\Us\Setup95] (Windows 95) or [D: Winnt40\Pcv\Us\Setupnt] (Windows NT) in the "command line" text box and click the "OK" button. The letter [D] may be different according to the drive you use.
  5. When the setup program starts up, follow the on-screen instructions.
  6. When the message "Completed" appears on screen, click the [Finish] button to complete the installation.
- Installation of Microsoft Internet Explorer 3.02 (or later) is required for optimum unit operation. Use the Jaaxdist.exe command should the unit appear to not be performing normally.

For Windows 3.1

1. Start up Windows.
2. Insert the Projector driver CD-ROM into your CD-ROM drive.
3. Select the [Run (R)] command on the icon menu so that the dialog box [Run] is displayed.
4. If you inserted the CD-ROM to drive D, type [D:Win31\Pcv\Us\Setup] in the "command line" text box and click the "OK" button. The letter [D] may be different according to the drive you use.
5. When the setup program starts up, follow the on-screen instructions.
6. When the message "completed" appears on screen, click the [OK] button to complete the installation.

For Macintosh

1. Start up Macintosh.
2. Insert the Projector driver CD-ROM into your CD-ROM drive.
3. Copy "PCV for Mac" file in the "PCV" folder to anywhere on the hard disk.

## Advanced feature with PC (Continue)

### Starting up PCV (For Windows)

For Windows 95 or Windows NT

1. Start up Windows.
2. Insert the PC card to the PC Card slot on the personal computer.
3. Start up Program Manager.  
Click the [Start] button and select the [Program (P)]→[Pcv]→[PCV]command.

For Windows 3.1

1. Start up Windows.
2. Insert the PC card to the PC Card slot on the personal computer.
3. Double click the [PCV] icon in the PCV folder.

### Command reference (For Windows 95)

The command references are as shown below:

#### File

- New presentation .... Create a new presentation.
- Open presentation... Opens an existing presentation.
- Close presentation ... Closes an opened presentation.
- Save presentation .... Saves an opened presentation using the same name.
- Save presentation As... Saves an opened presentation to a specified name.
- Delete presentation . Delete an opened presentation.
- Exit ..... Exits PCV.

#### Edit

- Cut ..... Deletes selected image from the presentation and moves it to the clipboard.
- Copy ..... Copies selected image data from the presentation to the clipboard.
- Paste ..... Pastes image data from the clipboard into the presentation.

#### Image

##### Add image

- Image file ..... Inserts image file to an opened presentation.
- Screen capture .... Captures screen and inserts it to an opened presentation.
- Delete image ..... Deletes the selected image from an opened presentation.
- Image information... Displays information of the selected image.

#### View

- Tool Bar ..... Shows or hides the toolbar.
- Drive Bar ..... Shows or hides the drivebar.
- Status Bar ..... Shows or hides the status bar.

#### Window

- Cascade ..... Arranges windows in an overlapped fashion.
- Tile Horizontal ..... Arranges windows in non-overlapped horizontal tiles.
- Tile Vertical ..... Arranges windows in non-overlapped vertical tiles.
- Arrange Icons ..... Arranges icons of closed windows.
- Windows 1, 2, ..... Goes to specified window.

#### Help

- Help Topics ..... Offers you an index to topics on which you can get help.
- Advanced settings ... Displays a detail setting of this application.
- About PCV ..... Displays the version information of this application.

### Command reference (For Windows 3.1)

The command references are as shown below:

#### File

- New presentation .... Create a new presentation.
- Open presentation ... Opens an existing presentation.
- Close presentation ... Closes an opened presentation.
- Save presentation .... Saves an opened presentation using the same name.
- Delete presentation... Delete an opened presentation.
- Open image file ..... Import an image from a file.
- Exit ..... Exits PCV.

#### Edit

- Cut ..... Deletes selected image from the presentation and moves it to the clipboard.
- Copy ..... Copies selected image data from the presentation to the clipboard.
- Paste ..... Pastes image data from the clipboard into the presentation.

#### Tool

- Capture ..... Captures screen and inserts it to an opened presentation.
- Delete image ..... Deletes the selected image from an opened presentation.

#### View

- Tool Bar ..... Shows or hides the toolbar.
- Status Bar ..... Shows or hides the status bar.
- Index image size ..... Select the size of index image.

#### Option

- Select card drive ..... Select (or change) the PC-CARD drive.
- Card drive inf ..... Display the information of the selected PC-CARD drive.

## Recording the image (For Windows)

When you wish to record the image of the display to a PC-CARD.

1. Choose the PC-CARD drive using the drive bar under the status bar.

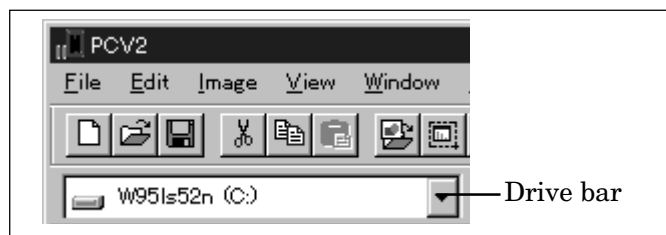

- If you are using Windows 3.1, select 'Select card drive' in Option menu of PCV main window.
2. Choose [New presentation...] under the [File] menu.  
The new presentation window will open.
  3. Choose [Add image] under the [Image] menu and then choose [Screen capture...].
    - The PCV windows disappear and the capture dialog box appears.

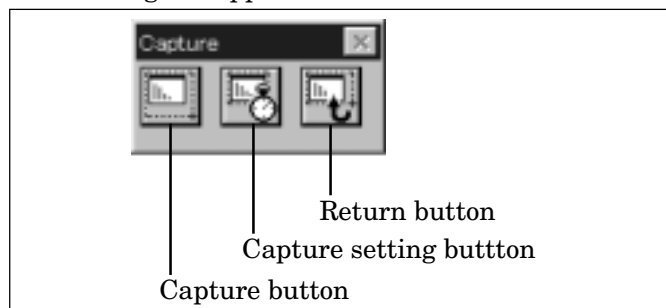

- If you are using Windows 3.1, select 'Image capture...' in TOOL of PCV main window.
4. Display the image you wish to record on the screen.
  5. Click the capture button.  
The Compress setting window appears.



6. Select the compress type.

Compress type	Speed	Capacity
High quality	Fast	Standard
Standard	Fast	Small
Low quality	Fast	Very small
No compress (BMP)	Slow	Large

- You can confirm the compressed image by clicking the Preview button.
- If the command [Preserving the setting] is checked, you don't need to set the style of save by each image (Not Windows 3.1).

7. Click OK button.
8. Repeat steps 4 to 7 for other images.



9. Click the return button.  
The presentation window will open. The recorded image appears on the presentation window.
  - Depending on the personal computer, the recorded image can appear incorrectly. In this case, set the delay time longer by using the Capture setting dialog box. Then repeat steps 5 to 7 again.
10. Choose [Save presentation...] under the [File] menu.
  - A presentation which has been recorded already, Select "Save As..." to save as.
11. Choose [Exit] under the [File] menu to quit from PCV.

When you wish to record the image from existing files.

1. Choose the PC-CARD drive using the drive bar under the status bar.
  - If you are using Windows 3.1, select 'Select card drive' in Option menu of PCV main window.
2. Choose [New presentation...] under the [File] menu.  
The new presentation window will open.
3. Choose [Add image] under the [Image] menu and then choose [Image file...].
  - If you are using Windows 3.1, select 'Open image file' in File menu of PCV main window.
4. Select the image you wish to record.
5. Click OK button.

The recorded image appears on the presentation window.

- The maximum number of group (presentation) that can be recorded to a PC card is 160. If the capacity of the PC CARD is low, the maximum number is less than 160.
  - The maximum number of the images that can be recorded to a group is 99.
6. Repeat steps 3 to 5 for other images.
  7. Choose [Save presentation...] under the [File] menu.
  8. Choose [Exit] under the [File] menu to quit from PCV.

## Advanced feature with PC (Continue)

### Editing the presentation (For Windows)

#### Delete the image

1. Select the image to be deleted.
2. Choose [Delete image...] under the [File] menu.
  - If you are using Windows 3.1, choose [Delete image] under the [Option] menu.

#### Sequencing

##### A. Exchange images

You can exchange the images among images next to each other.

1. Select an image to be exchanged.
2. Drag the image and drop on the next or previous image.

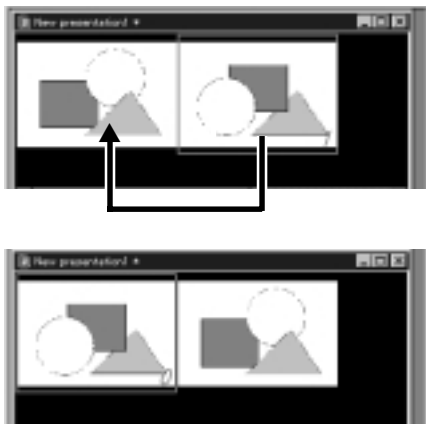

##### B. Move images

You can move images to other positions.

1. Select an image to be moved.
2. Drag the image and drop it on the other image (except next or previous image).  
The image will be moved to the previous position of the dropped image.

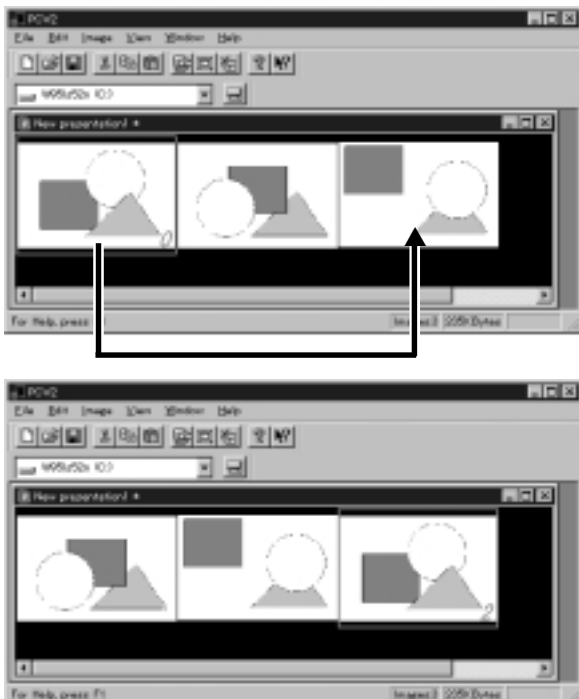

### Preview an image

1. Double click the image.  
The preview image appears on the displays.

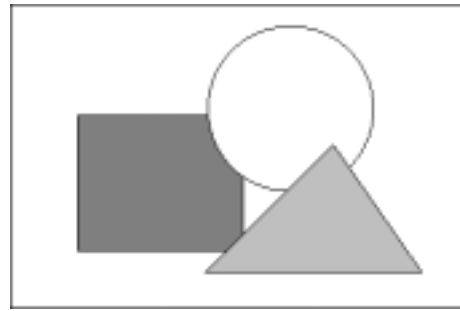

2. Click the image by using the left button of the mouse (or press Enter key on your keyboard.)

### Display image information

1. Choose [Image information] under the [Image] menu.

The image information window appears.

- If you are using Windows 3.1, choose the image by clicking the right button of the mouse.

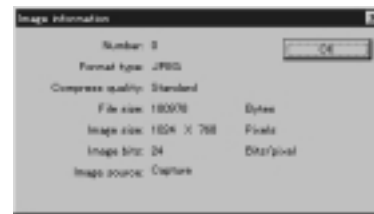

2. Choose OK to close the image information window.

### How to save a file which has been made by a presentation software (For Windows 95 only)

1. Make up a presentation by the presentation software.
2. Choose [Print] under the [File] menu.
3. Set to PCV driver for printing name.

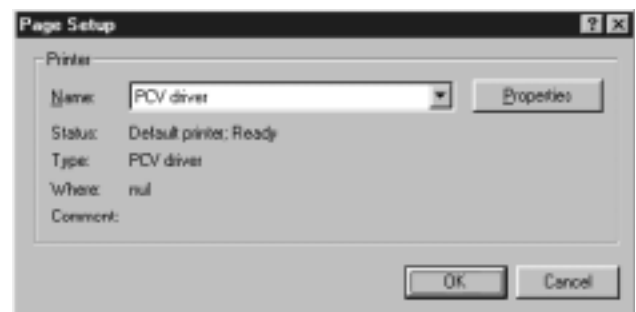

- PCV drive will automatically be installed in the system of the personal computer when PCV is installed.

- Click the properties button.



- If necessary, set the Resolution, Expand, File Format or JPEG Quality.
- Click OK button on the PCV driver Properties dialog box.
- Click OK button.
- Choose the PC-CARD drive.
- Click OK button.
  - The presentation data will be saved as PCVdrv on PC card.
  - PCVdrv is a temporary file. If you record presentation continuously, the previous data will be erased. The projector may not work correctly when playing back "PCVdrv" file on it. Please follow as below to rename the file.
- Boot up PCV's program.
- Choose [Open presentation...] under the [File] menu.
- Select PCVdrv file and click Open button. The presentation window will open and the recorded image appears on the presentation window.
- Choose [Save presentation As...] under the [File] menu and click OK button.
- Click Yes(Y) button.
- Choose [Exit] under the [File] menu to quit from PCV.
  - The file recorded with PCV driver cannot show the index display until re-recorded by PCV software.

## Starting up PCV (For Macintosh)

- Start up Macintosh.
- Insert the PC card to the PC Card slot on the personal computer.
- Double click the [PCV for Mac] icon.

### Command reference

The command references are as shown below:

#### File

- Create New presentation . Create a new presentation.
- Open presentation... Opens an existing presentation.
- Close presentation ... Closes an opened presentation.
- Save presentation .... Saves an opened presentation using the same name.
- Delete presentation . Delete an opened presentation.
- Open image file... ..... Import an image from a file.
- Done ..... Exits PCV.

#### Edit

- Cut ..... Deletes selected image from the presentation and moves it to the clipboard.
- Copy ..... Copies selected image data from the presentation to the clipboard.
- Paste ..... Pastes image data from the clipboard into the presentation.
- Clear... ..... Deletes the selected image from an opened presentation.

#### Option

- Preference... ..... Select the format BMP or JPEG.
- Get Screen Shot Image .... Captures screen and inserts it to a presentation.

## Recording the image (For Macintosh)

When you wish to record the image of the display to a PC-CARD.

- Display the image you wish to record on the screen.
- Press the shift button, command button and number 3 button simultaneously.
- Repeat steps 1 and 2 for other images.
- Choose [Get Screen Shot Image] under the [Option] menu.

The presentation window will open. The recorded image appears on the presentation window.



- The file type to be recorded is BMP or JPEG. To change file type, select [Preference] under the [Option] menu then change setting. Reboot PCV.
- Choose [Save presentation...] under the [File] menu.
  - Choose [Done] under the [File] menu to quit from PCV.

## Advanced feature with PC (Continue)

When you wish to record the image from existing files.

1. Choose [Create New presentation...] under the [File] menu.  
The new presentation window will open.
2. Choose [Open image file] under the [File] menu.
3. Select the image you wish to record.
4. Click OK button.  
The recorded image appears on the presentation window.
5. Choose [Save presentation...] under the [File] menu.
6. Choose [Done] under the [File] menu to quit from PCV.

### Editing the presentation (For Macintosh)

#### Delete the image

1. Select the image to be deleted.
2. Choose [Clear] under the [File] menu.

#### Sequencing

##### A. Exchange images

You can exchange the images among images next to each other.

1. Select an image to be exchanged.
2. Drag the image and drop on the next or previous image.



##### B. Move images

You can move images to other positions.

1. Select an image to be moved.
2. Drag the image and drop it on the other image (except next or previous image).  
The image will be moved to the previous position of the dropped image.



##### Preview an image

1. Select an image to be previewed.
2. Double click the image.  
The preview image appears on the displays.



## Mouse remote control

By connecting to personal computer through PS/2 (or ADB) port, you can operate your computer with the projector remote control.

### Connection

#### Projector + IBM PC or IBM PC compatibles

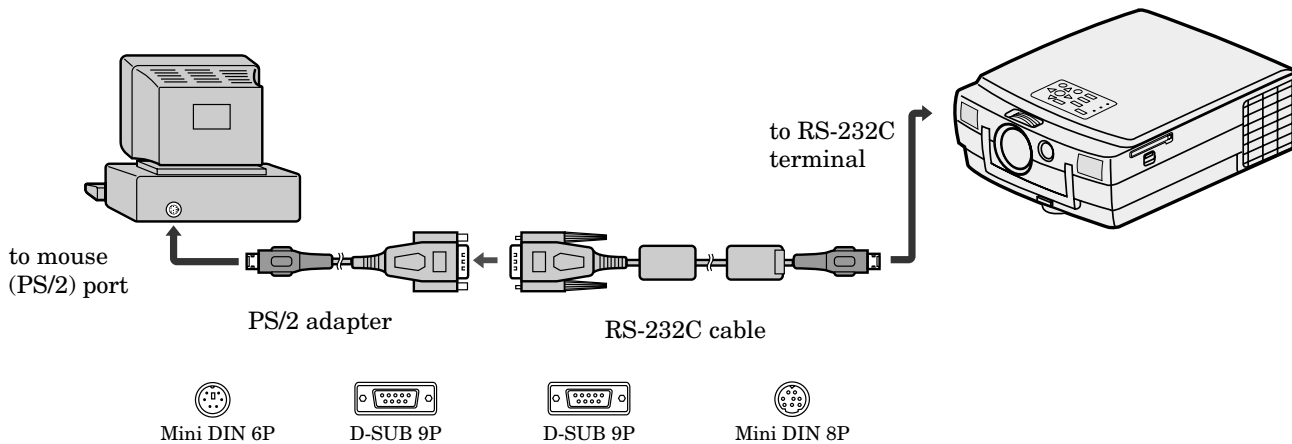

#### Projector + Macintosh

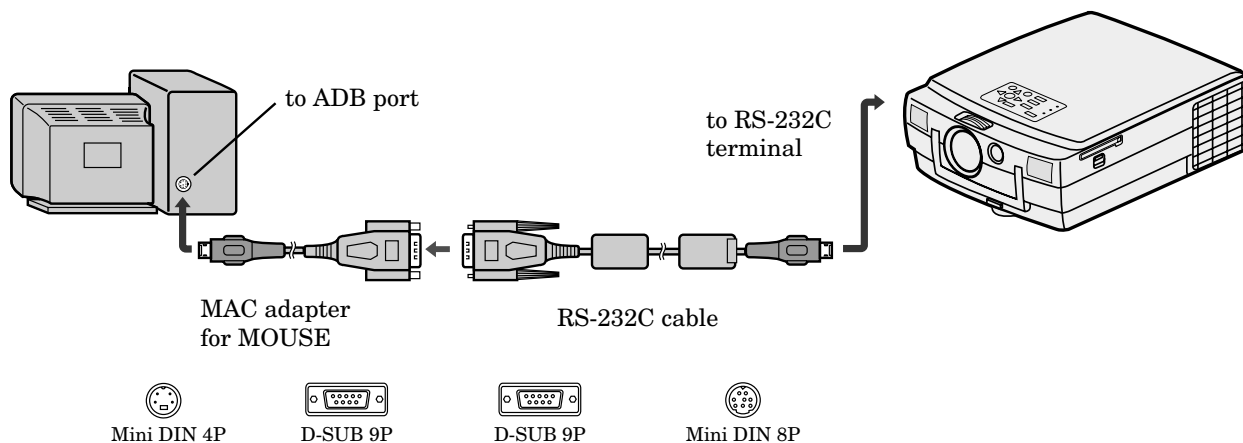

### Operation

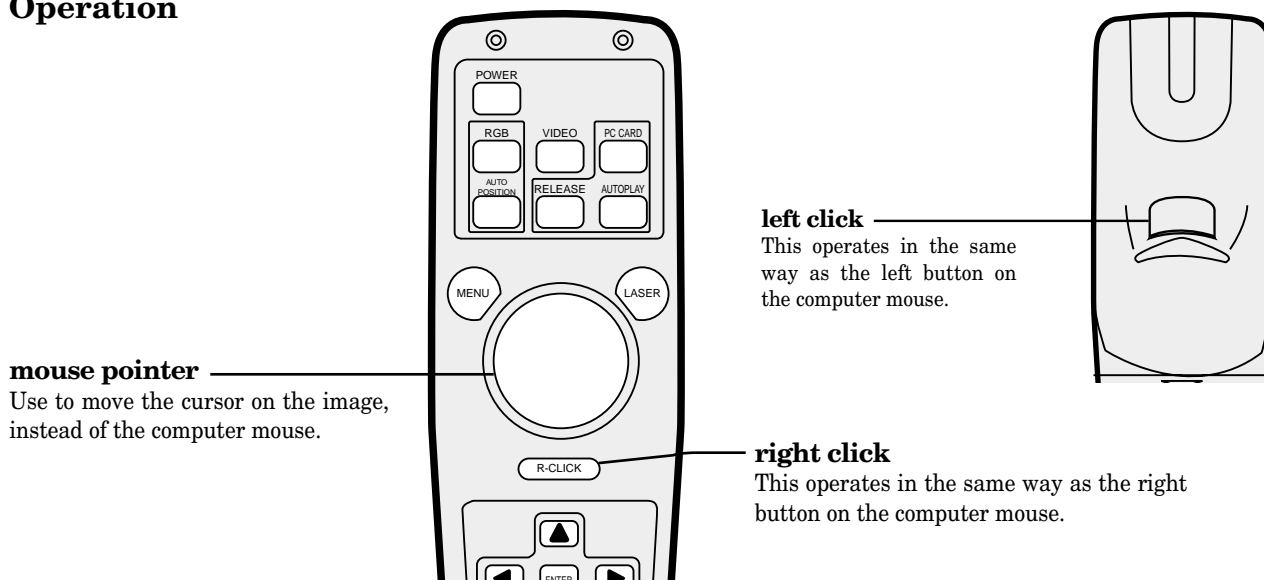

- If the mouse remote control is not working, restart the computer.

# Replacement of a light source lamp

The light source lamp is designed to project the image on the LCD panels. When the light source lamp no longer functions, replace it with a new one to ensure optimum performance.

## Caution:

- Do not remove the light source lamp from inside of this equipment immediately after using the projector, you may get burned because of the high temperature of the light source lamp.
- When you replace the light source lamp, press the power button to power off, then wait for 120 seconds in stand-by mode to cool down the lamp and LCD panels. Turn off the main switch, unplug the power cord from the outlet and wait one hour so that the lamp is cooled to the touch.
- Do not remove the light source lamp except for replacement. Careless treatment can cause injury or fire.
- Do not touch the lamp element directly. It may be broken and may cause you to injure or burn yourself.
- Be sure not to drop the screws into the projector. Also be sure not to insert metal or any flammable objects, it may cause fire or an electric shock. If any objects are inserted, please unplug and contact your dealer.
- Install the lamp securely, failure may cause fire.

1. Stand the projector as shown in the direction of the arrow.

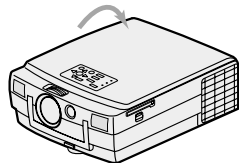

2. Loosen the screws of the lamp lid on the top cover using a phillips screwdriver (+), and remove the lid.
  - Remove the lamp cover in the direction of the arrow as indicated.

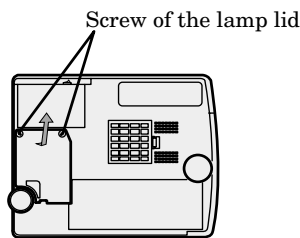

3. Loosen screws (a) using a phillips screwdriver (+), and remove them.

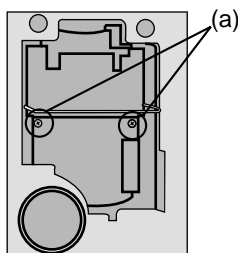

- Do not lose the screws.

4. Hold onto the projector by the handle as you pull out the lamp.

Once the lamp has been removed, do not spill liquid on it, place it near flammable objects or where children can touch it. Otherwise, it will cause injury or fire.

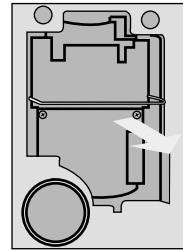

5. Insert the new lamp securely into the projector body in the right direction.

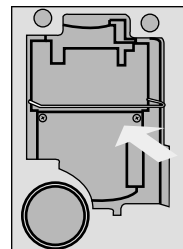

6. Tighten up the screws (a) which have been removed in step 3 using a phillips screwdriver (+).

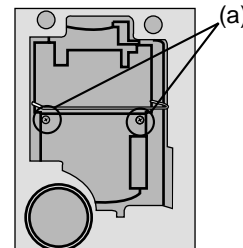

7. Tighten up the screws of the lamp lid using a phillips screwdriver (+).

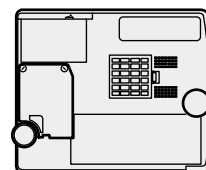



---

### How to reset the operation time meter

Plug in the power cord, switch on the projector and reset lamp time by pressing the ◀, ▶ and POWER buttons simultaneously.

#### Caution:

- The lamp you have removed, do not spill liquids on it, place it near flammable objects or where children can touch it. Otherwise, it will cause injury or fire.
- Be sure that the projector guide is firmly inserted between the right and left lamp guides.

#### Important:

- The projector will not turn on if you do not secure the lamp lid.
- The operation time meter must be reset after the lamp has been replaced.
- Do not reset the operation time meter unless the lamp has been replaced.

### The life of the lamp

The average life of the lamp for the projector is about 2,000 hours of consecutive use. Life span may differ according to operating environment, and may be shorter than 2,000 hours. Decreases in luminescence and/or color brightness will indicate that the light source lamp is in need of replacement. When lamp operation time exceeds 1,500 hours, the indicator will flash alternately between green and red (while the lamp is in operation; when the lamp is not in operation, the indicator will appear red only). When the lamp has been used for about 1,900 hours, the message "LAMP!!" will appear on the screen for one minute. When the lamp has been used for about 2,000 hours, the projector will automatically shut off for the safety of the lamp and the power indicator light up in red. The projector cannot be used until the lamp has been replaced and operation timer has been reset.

#### Caution:

- The light source lamp is fragile. If broken be careful not to cut yourself with glass fragments.
- The lamp life depends on the environment. For replacement lamps, please contact your dealer.

**The projector automatically shuts off when the lamp is used up in about 2,000 hours and the projector won't come on until the lamp is exchanged and operation timer reset.**

# Maintenance

## Caution:

Be sure to turn off the projector and unplug the power cord from the wall outlet before you perform any maintenance on the projector.

## Cleaning the air-filter

Clean the air-filter frequently. If the filter or ventilation slots become clogged with dirt or dust, the temperature inside of the projector may rise and shut off the power (the TEMP indicator starts to blink red).

1. Press and raise the air-filter cover with a screwdriver (-).

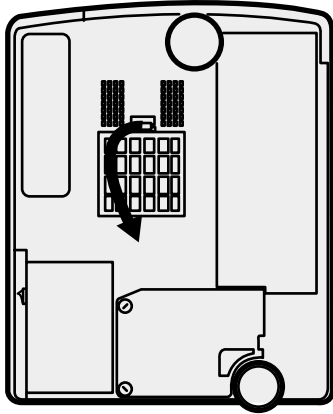

2. Wash the air-filter.

Use water or a mild detergent diluted with water to clean the filter. Rinse the filter thoroughly and let it dry completely. If the filter is damaged or becomes extremely dirty, contact your dealer for replacement information.

3. Attach the air filter to the cover.

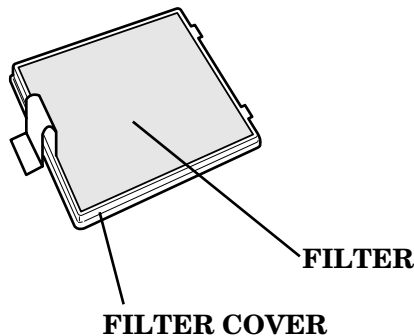

4. Reinstall the air-filter cover.

Note: The power will not turn on if the air-filter cover is improperly installed.

## Caution:

Be sure to use the projector with an air-filter. If not, dust may get inside the projector, causing a fire or a breakdown.

## Cleaning the projector and the ventilation slots

Use a soft cloth to clean the projector and the ventilation slots. When the slots become dirty, wipe them with a soft cloth dampened with a diluted mild detergent, and then wipe them with a dry cloth.

To protect the surface of the projector from fading or deteriorating:

- Do not spray insecticide on or inside the projector.
- Do not use benzine or thinner to clean it.
- Do not let rubber or plastic materials come into contact with the projector.

## Cleaning the lens

Use a standard lens-cleaning brush or a piece of lens tissue dampened with lens cleaning fluid. The lens surface is fragile. Use only recommended, nonabrasive lens-cleaning materials. Do not touch the lens with your fingers.

# Troubleshooting

The following offers solutions to some of the common problems you may encounter. We suggest that you consult this chart before contacting your dealer.

PROBLEMS	CAUSE	POSSIBLE SOLUTIONS
The power is off.	<ul style="list-style-type: none"> <li>The air intake vents, exhaust vents or air filter is clogged with dust or some object.</li> </ul> <p><b>POWER indicator does not light up.</b></p> <ul style="list-style-type: none"> <li>Power cord is unplugged from the outlet.</li> <li>Power cord is disconnected from the projector.</li> <li>The main switch is turned off.</li> <li>The lamp lid is open.</li> </ul> <p><b>POWER indicator blinks red.</b></p> <ul style="list-style-type: none"> <li>The projector has been turned on again too soon after having been turned off.</li> <li>When the power switch was turned off while the fan was running, during or after lamp operation.</li> <li>The room temperature is too high. (Does the LAMP indicator show an unusual condition?)</li> <li>Lamp is no longer working.</li> </ul> <p><b>POWER indicator blinks between red and green.</b></p> <ul style="list-style-type: none"> <li>The filter cover or lamp cover is not closed.</li> <li>When the LAMP indicator or the TEMP indicator is either on or blinking, the main unit requires repairs.</li> </ul>	<ul style="list-style-type: none"> <li>Remove the object.</li> <li>Plug the power cord into the outlet.</li> <li>Insert the power cord into the projector.</li> <li>Turn the main switch on.</li> <li>Close the lamp lid.</li> <li>Wait for the lighting sequence.</li> <li>Turn the power switch on and off several times.</li> <li>Refer to "Indicators" on page 36.</li> <li>Replace the lamp with a new one.</li> <li>Close the cover correctly.</li> <li>Contact your dealer.</li> </ul>
No picture appears on the screen.	<ul style="list-style-type: none"> <li>Lens is covered by lens cap.</li> <li>When the LAMP indicator or the TEMP indicator is either on or blinking, the main unit requires repairs.</li> <li>The equipment connected to this projector is not turned on.</li> <li>Hookup is not made correctly with other equipment.</li> <li>The input source is not selected correctly.</li> </ul>	<ul style="list-style-type: none"> <li>Take the lens cap off.</li> <li>Replace the lamp with a new one.</li> <li>Turn on the connected equipment.</li> <li>Confirm the hookup.</li> <li>Select the correct source according to the equipment connected to this projector.</li> </ul>
The image is distorted.	<ul style="list-style-type: none"> <li>The projector is not at a right angle to the screen.</li> </ul>	<ul style="list-style-type: none"> <li>Adjust the angle of the projector to make a right angle to the screen. See page 11.</li> </ul>
The image is dark.	<ul style="list-style-type: none"> <li>Brightness, tint and color are not adjusted correctly.</li> </ul>	<ul style="list-style-type: none"> <li>Adjust brightness, tint and color correctly.</li> </ul>
The image is blurred.	<ul style="list-style-type: none"> <li>The projecting distance is beyond the focused area.</li> <li>Lens is dirty.</li> <li>Screen size exceeds screen size specifications.</li> <li>Brightness and contrast are not adjusted correctly.</li> <li>FINE adjustment is not made correctly.</li> <li>Tracking is not adjusted.</li> <li>The projector is not at a right angle to the screen.</li> </ul>	<ul style="list-style-type: none"> <li>Adjust the projecting distance. See page 10.</li> <li>Clean lens.</li> <li>Reduce screen size to within 23" to 245".</li> <li>Adjust brightness, contrast.</li> <li>Make FINE adjustment.</li> <li>Adjust tracking.</li> <li>Adjust the angle of the projector to make a right angle to the screen. See page 11.</li> </ul>
The image remains blurred.	<ul style="list-style-type: none"> <li>When you see the stationary image for a long time, it may remain on the screen if you change the image. It is not a breakdown. The blurred image will disappear in a few minutes.</li> </ul>	
Red, blue or green dots are viewed on the text of image.	<ul style="list-style-type: none"> <li>It is normal.</li> </ul>	
The image is distorted on the screen and noise is heard.	<ul style="list-style-type: none"> <li>The cable for connection with other equipment is not plugged securely into the terminal.</li> <li>The projector is installed too close to other equipment.</li> </ul>	<ul style="list-style-type: none"> <li>Plug the connecting cable securely into the terminal. See pages 12-14.</li> <li>Install the projector far away from other equipment.</li> </ul>
No sound is heard.	<ul style="list-style-type: none"> <li>Volume is not turned up.</li> <li>Connection to other equipment is not made correctly.</li> </ul>	<ul style="list-style-type: none"> <li>Turn up the volume.</li> <li>Check connections. See pages 12-14.</li> </ul>
Nothing is displayed on the PC monitor.	<ul style="list-style-type: none"> <li>The PC monitor is not turned on.</li> </ul>	<ul style="list-style-type: none"> <li>Turn on the monitor.</li> </ul>
Warm air comes out of the exhaust vents.	<ul style="list-style-type: none"> <li>This is typical of the LCD projector.</li> </ul>	
Adjustments cannot be made.	<ul style="list-style-type: none"> <li>The operation is incorrectly made due to noise or interference.</li> </ul>	<ul style="list-style-type: none"> <li>Press the MENU and POWER buttons simultaneously. See page 17.</li> </ul>

# Indicators

The projector has three indicators each of which shows the working condition of the projector.

The following offers solutions to possible problems. If a problem persists, turn the projector off and consult your dealer.

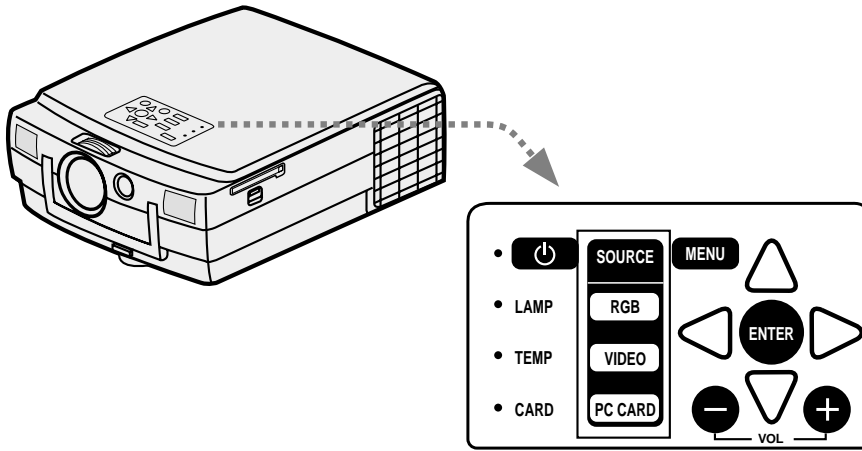

INDICATOR	SHOWS	CONDITION	POSSIBLE SOLUTIONS
TEMP INDICATOR	blinking red	<ul style="list-style-type: none"> <li>Unusual temperature The power is turned off and the POWER indicator lights up red.</li> <li>The ventilation slots or air filter is clogged with dust or debris.</li> <li>The fan has stopped due to an impediment.</li> </ul>	<ul style="list-style-type: none"> <li>Remove the object from the ventilation slots.</li> <li>Pull out the power plug and remove the object. If you cannot, consult your dealer.</li> <li>Relocate the projector to a cooler place.</li> <li>Clean the filter.</li> </ul>
		<ul style="list-style-type: none"> <li>The room temperature is too high.</li> <li>The filter is dirty.</li> </ul>	
LAMP INDICATOR	Steady green	Normal	-
	Blinking red/green or Blinking red	Lamp is almost used up.	Replace the lamp. Exchange with a new lamp if the same problem recurs.
	Steady red	<ul style="list-style-type: none"> <li>Lamp is used up.</li> <li>The power is not turned on. (Power indicator lights up red.)</li> </ul>	
POWER INDICATOR	Steady red	Standby	-
	Steady green	Power-on	-
	Blinking red/green or Blinking red	<ul style="list-style-type: none"> <li>The filter cover is not closed. (When the TEMP indicator and the LAMP indicator are off.)</li> <li>Abnormal (When the TEMP indicator or the LAMP indicator-steady on or blinking.)</li> </ul>	<ul style="list-style-type: none"> <li>Close the cover correctly.</li> <li>Contact your dealer.</li> </ul>

# Specifications

Type	LCD projector
Model	LVP-S120A
Rated power supply	AC100 ~ 240V, 50 / 60Hz
Rated input	2.3A
LCD panels	0.9-inch LCD panel: 3 pieces (for R, G, B) Pixels 800 × 600 = 480,000 pixels Total 1,440,000 pixels Active pixel rate: 99.99 % or more (each panel)
Projection lens	F 1.8~2.1 f = 36 ~ 47 mm
Light source lamp	150 W DC mercury lamp
Picture size	23~245 inch (aspect ratio 4:3)
Audio output	1 W monaural
Speaker	6 cm square type (8Ω 1W) × 1 pcs.
S-video input	Luminance signal: 1.0 Vp-p 75Ω (negative sync.) Chroma signal: 0.286 Vp-p 75Ω (burst signal)
Video input	1.0 Vp-p 75Ω (negative sync.)
Audio inputs	350 mVrms, 10kΩ or more
Analog RGB input (mini D-SUB 15P)	RGB: 0.7Vp-p 75Ω (negative sync.) YCbCr: Y:1.0Vp-p (negative sync.) CbCr:0.7Vp-p HD/CS : TTL level (positive or negative) VD : TTL level (positive or negative)
PC audio input	350 mVrms, 10kΩ or more ø3.5mm stereo mini jack
Control connector	Serial (Mini DIN 8 pin female connector) RS-232C standards
Outside dimensions	264 × 115 × 340 mm (width × height × depth) Legs are not included.
Weight	Approx. 10 lbs (4.5kg)
Length of power cord	114 inch (2.9m)
Temperature, humidity (performance guarantee)	+41°F (+5°C) ~ +95°F (+35°C), 30~90%

## Replacement parts list

### What's included in the box

1 AC power cable	246C346-10	1 Remote control	939P763-10
1 RCA video cable	246C323-10	1 Warranty card	854B318-10
1 Audio cable	242C938-10	1 User's manual	871D275-10
1 RGB cable for PC	246C318-10	1 Software (CD-ROM)	919P116-10
1 MAC adapter for RGB cable	246C319-20	2 Battery for remote	—
1 RS-232C cable	246C366-10		
1 MAC adapter for RS-232C cable	246C321-10		
1 PS/2 adapter	246C367-10		
1 MAC adapter for MOUSE	246C368-10		

### Accessories

1 Spare mercury-arc lamp	499C004-01
1 PC audio cable	242D493-10



**LCD**  

---

**Projector**  

---

**User Manual**  

---

**S 120**

APPENDIX

MODEL LVP-S120A

# Control this projector by using a personal computer

This projector can be controlled by connecting a personal computer with RS-232C terminal.

## Connection

### Projector + IBM PC or IBM PC compatibles

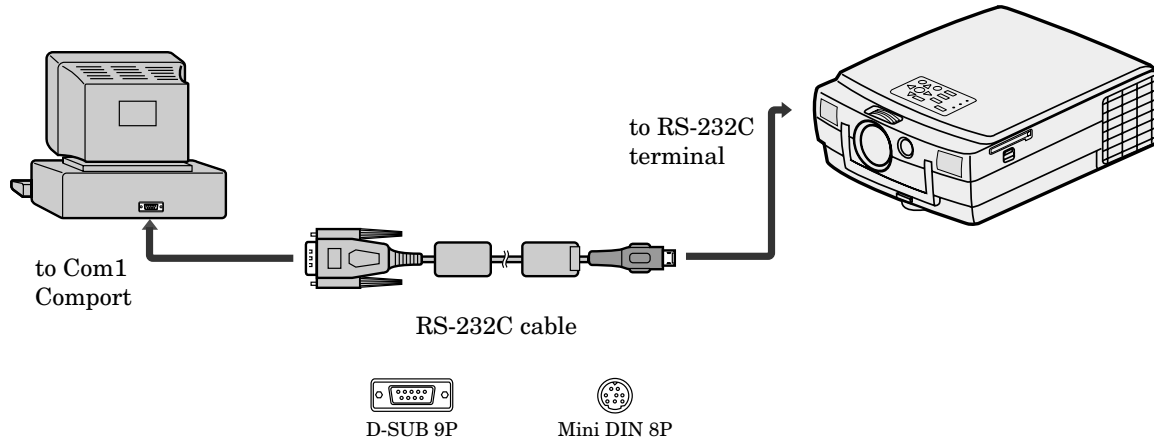

Note: If your PC (IBM or IBM compatible) is equipped only with a 25-pin serial port connector, a 25-pin serial port adapter is required. Contact your dealer for details.

### Projector + Macintosh

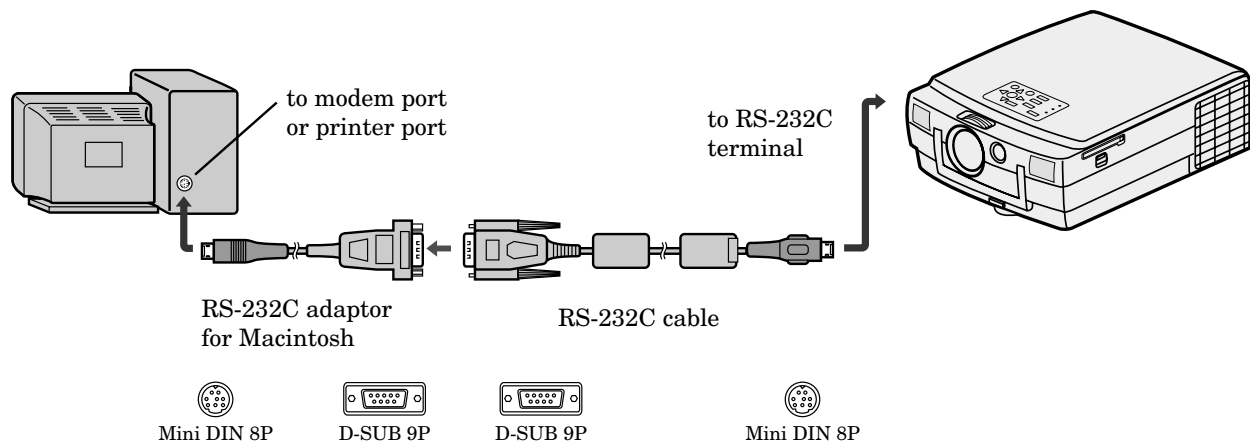







Functions can be controlled by a personal computer:

- Turn the ON or OFF
- Changing input signals
- Button input by remote control
- Reading warning data
- Picture adjustment

By making a programme, you can also control this projector by a personal computer automatically.

[EXAMPLE]

Time	Movement	Commands to be used (ASCII code)
8:40 a.m.	Turn the power ON	0 0 ! 
	Change input to RGB	0 0 _ r 1 
0:20 p.m.	Turn the power OFF	0 0 " 
1:00 p.m.	Turn the power ON	0 0 ! 
3:00 p.m.	Change input to VIDEO	0 0 _ v 1 
5:20 p.m.	Turn the power OFF	0 0 " 

### 1) Interface

PROTOCOL	RS-232C
BAUD RATE	9600 [bps]
DATA LENGTH	8 [bits]
PARITY BIT	NONE
STOP BIT	1 [bits]
FLOW CONTROL	NONE

This projector uses RXD, TXD and GND lines for RS-232C control.  
For RS-232C cable, the reverse type cable should be used.

### 2) Control command diagram

The command is structured by the address code, function code, data code and end code. The length of the command is different by each function.

	Address code	Function code	Data code	End code
HEX	30h 30h	Function	Data	0Dh
ASCII	'0' '0'	Function	Data	

[Address code] 30h 30h (In ASCII code, '0' '0') fixed.

[Function code] A code of each fixed control move

[Data code] A code of each fixed control data (number) and not always indicated.

[End code] 0Dh (In ASCII code, ') fixed.

### 3) Control sequence

- (1) The command from a personal computer to the projector will be sent in 400ms.
  - (2) The projector will send a return command 400ms\* after it has received an encode. if the command isn't received correctly, the projector will not send the return command.
  - (3) The personal computer checks the command and confirms that if the command which has been sent has been executed or not.
  - (4) This projector sends various codes, other than the return code. When having a control sequence by RS-232C, reject other codes from personal computer side.
- \* : The sending time of return command may delay depending on the condition (during changing the input signal, playing back the PC card, etc.).



## Control this projector by using a personal computer (Continue)

[Example] Turn the power ON (' is for ASCII code)

Sending commands from the PC etc.	Status code from projector	Meaning
30 30 21 0D '0' '0' '!' '␣'		Command for POWER ON
	30 30 21 0D '0' '0' '!' '␣'	Command received (Command echo back)

### 4) Operation commands

The operation commands execute the basic operation setting of this projector. It may not operate when changing the signal.

	ASCII	HEX
POWER ON	!	21h
POWER OFF	"	22h
INPUT RGB	_r1	5Fh 72h 31h
INPUT VIDEO	_v1	5Fh 76h 31h
INPUT CARD	_c1	5Fh 63h 31h

- POWER OFF command will not work for 1 minute after the power is turned on.
- POWER ON command will not work for 1 minute after the power is turned off.

[Example] Set the input signal to RGB (' is for ASCII code)

Sending commands from the PC etc.	Status code from projector	Meaning
30 30 5F 72 31 0D '0' '0' '_' 'r' '1' '␣'		Command for setting the input signal to RGB
	30 30 5F 72 31 0D '0' '0' '_' 'r' '1' '␣'	Command received (Command echo back)

### 5) Remote commands

The some remote control operation can be done by remote command codes.

Button's name on remote	ASCII	HEX
+ VOLUME	r06	72h 30h 36h
- VOLUME	r07	72h 30h 37h
EXPAND	r02	72h 30h 32h
▲	r53	72h 35h 33h
▼	r2b	72h 32h 62h
◀	r4f	72h 34h 66h
▶	r59	72h 35h 39h
MENU	r54	72h 35h 34h
ENTER	r10	72h 31h 30h
AUTO PLAY(PC CARD)	r32	72h 33h 32h
RELEASE(PC CARD)	r22	72h 32h 32h
AUTO POSITION	r09	72h 30h 39h
STILL	ra4	72h 61h 34h

[Example] Display MENU selection bar. (' is for ASCII code)

Sending commands from the PC etc.	Status code from projector	Meaning
30 30 72 35 34 0D '0' '0' 'r' '5' '4' '␣'		Command as same as MENU button
	30 30 72 35 34 0D '0' '0' 'r' '5' '4' '␣'	Command received (Command echo back)

## 6) Warning commands

Read the past warning data. The personal computer doesn't attach the data code onto the warning commands to send. On the other hand, the projector which has received a command, attach the warning data as the data code to reply.

	ASCII	HEX
past data	Ep	45h 70h
clear past data	Ec	45h 63h

The past data

Ep\* (\* is 6 digits, hexadecimal notation)

\*=(MBS)b1,b2,b3,b4,b5,b6,b7,b8, b9, b10, b11, b12, b13, b14, b15, b16, b17, b18, b19, b20, b21, 000(LSB)

b1=Operation time (during boot up '0' / when the power is ON, '1')

b2=Standby power short

b3=Switch power short

b4=0

b5=0

b6=0

b7=The fan is stopped.

b8=The lamp cover is not closed.

b9=The filter cover is not closed.

b10=The temperature sensor is off (Exhausting fan)

b11=The temperature sensor is off (The lamp)

b12=Communication error between microcomputer

b13=Communication error between microcomputer (Parallel bus)

b14=Abnormal temperature (the lamp)

b15=Abnormal temperature (outside)

b16=Abnormal temperature (LCD)

b17=The lamp is not illuminating.

b18=Confirmation mode for the operating status

b19=0

b20=0

b21= The life of a lamp

[Example 1] The fan was down when the power was ON and the past data of the warning was confirmed.

Sending commands from the PC etc.	Status code from projector	Meaning
30 30 45 70 OD '0' '0' 'E' 'p' '↵'		Commnd for confirm past data
	30 30 45 70 38 32 30 30 30 0D '0' '0' 'E' 'p' '8' '2' '0' '0' '0' '0' '↵'	Warning command (Fan is stopped when the power is ON) carried out

\*: '8' '2' '0' '0' '0' '0' mean the numbers as shown below

Bit	b1 b2 b3 b4	b5 b6 b7 b8	b9 b10 b11 b12	b13 b14 b15 b16	b17 b18 b19 b20	b21 0 0 0
ASCII	1 0 0 0	0 0 1 0	0 0 0 0	0 0 0 0	0 0 0 0	0 0 0 0
HEX	8	2	0	0	0	0

b1=1 (The power is ON), b7=1 (The fan is stopped), Other=0

## 7) Reading command diagram

Monitor projector operation status. The power ON, OFF and input terminal settings can be monitored.

	ASCII		HEX	
	Function	Data (Receive)	Function	Data (Receive)
POWER ON	vP	1	76h 50h	31h
POWER OFF	vP	0	76h 50h	30h
INPUT RGB	vI	r1	76h 49h	72h 31h
INPUT VIDEO	vI	v1	76h 49h	76h 31h
INPUT CARD	vI	c1	76h 49h	63h31h

## Control this projector by using a personal computer (Continue)

When a personal computer sends the command, data code will not be attached. On the other hand, the projector which has received a command will attach the recent operating status then send.

[Example ] Input was Video 1 when the operating status of the input terminal was confirmed.

Sending commands from the PC etc.	Status code from projector	Meaning
30 30 76 49 0D '0' '0' 'v' 'I' '↵'		Command for confirm input
	30 30 76 49 76 31 0D '0' '0' 'v' 'I' 'v' '1' '↵'	Command (Input is Video) carried out

### 8) Picture adjustment commands

The picture adjustment commands execute the picture adjustment setting of this projector. If the personal computer doesn't send the commands without attaching the data code, the projector which has received the command replays the setting data as data code.

	ASCII	HEX
CONTRAST	P	50h
BRIGHTNESS	Q	51h
SHARPNESS	R	52h
TINT	S	53h
COLOR	T	54h

#### How to set the grade

The data code of CONTRAST and BRIGHTNESS is structured by the difference data of R from G, the main data and the difference data of B from G. Use ASCII letters code to set the grade for setting data. Please refer to the table below for HEX code.

ASCII	'+'	'-'	'0'	'1'	'2'	'3'	'4'	'5'	'6'	'7'	'8'	'9'
HEX	2Bh	2Dh	30h	31h	32h	33h	34h	35h	36h	37h	38h	39h

[Example 1] Set the difference data of R from G to +10, the setting main data to 0 and the difference data of B from to -5.

Sending commands from the PC etc.	Status code from projector	Meaning
30 30 50 2B 31 30 2B 30 30 2D 30 35 0D '0' '0' 'P' '+' '1' '0' '+' '0' '0' '-' '0' '5' '↵'		Command for setting the picture control
	30 30 50 2B 31 30 2B 30 30 2D 30 35 0D '0' '0' 'P' '+' '1' '0' '+' '0' '0' '-' '0' '5' '↵'	Command received (Command echo back)

[Example 2] The TINT was set to +10 when the setting status was confirmed.

Sending commands from the PC etc.	Status code from projector	Meaning
30 30 53 0D '0' '0' 'S' '↵'		Command for confirm setting of TINT
	30 30 53 2B 31 30 0D '0' '0' 'S' '+' '1' '0' '↵'	Command (setting of TINT is +10) carried out

- When the command of CONTRAST or BRIGHTNESS is sent from the computer, the setting of the COLOR TEMP on the menu is set to "USER".
- For the same condition as "HIGH" or "LOW" of the COLOR TEMP, change the CONTRAST and BRIGHTNESS settings as shown below.

#### COLOR TEMP "HIGH"

	difference data of R from G	difference data of B from G
CONTRAST	-10	+10
BRIGHTNESS	+00	+00

#### COLOR TEMP "LOW"

	difference data of R from G	difference data of B from G
CONTRAST	+10	-10
BRIGHTNESS	+00	+00



**MITSUBISHI ELECTRONICS AMERICA, INC.**  
5665 Plaza Drive  
Cypress, CA 90630