



EN Operating instructions. pages 1 to 20
Translation of the original operating instructions

FR Vous trouverez la version actuelle du mode d'emploi dans votre langue nationale officielle sur l'Internet, www.schmersal.net.

ES Encontrará el manual de instrucciones actual en su idioma oficial de la UE en nuestra página de Internet www.schmersal.net.

NL U vindt de huidige versie van de gebruikshandleiding in uw officiële landstaal op het Internet, www.schmersal.net.

IT Il manuale d'istruzioni aggiornato nella vostra lingua (lingua ufficiale UE) è scaricabile in Internet all'indirizzo www.schmersal.net.

JP EU公用語で書かれた最新の取扱説明書は、インターネット (www.schmersal.net) からダウンロードできます。

Content

| | | |
|----------|---|----|
| 1 | About this document | |
| 1.1 | Function | 1 |
| 1.2 | Target group: authorised qualified personnel. | 1 |
| 1.3 | Explanation of the symbols used | 1 |
| 1.4 | Appropriate use | 1 |
| 1.5 | General safety instructions | 2 |
| 1.6 | Warning about misuse | 2 |
| 1.7 | Exclusion of liability | 2 |
| 2 | Product description | |
| 2.1 | Ordering code | 2 |
| 2.2 | Special versions. | 2 |
| 2.3 | Scope of delivery and accessories | 2 |
| 2.3.1 | Optional accessories | 2 |
| 2.4 | Destination and use | 2 |
| 2.5 | Technical data | 3 |
| 2.6 | Response time (reaction time). | 3 |
| 2.7 | Safety classification | 4 |
| 2.8 | Functions | 4 |
| 2.8.1 | Factory setting | 4 |
| 2.8.2 | Restart interlock (manual reset). | 4 |
| 2.8.3 | Contact control (EDM) | 4 |
| 2.8.4 | Start interlock. | 4 |
| 2.8.5 | Beam coding | 4 |
| 2.8.6 | Blanking | 5 |
| 2.8.7 | Testing | 6 |
| 2.9 | Operating mode muting | 6 |
| 2.9.1 | Muting sensors MS | 6 |
| 2.9.2 | Muting lamp | 7 |
| 2.9.3 | Signal sequence muting. | 7 |
| 2.9.4 | Configuration of the muting function | 7 |
| 2.9.5 | Saving the data | 9 |
| 2.9.6 | Muting applications | 9 |
| 2.10 | Operating mode cyclic operation | 10 |
| 3 | Mounting | |
| 3.1 | General conditions. | 11 |
| 3.2 | Protection field and approach | 11 |
| 3.3 | Alignment. | 12 |
| 3.4 | Safety distance | 12 |
| 3.4.1 | Minimum distance to reflecting surfaces | 13 |
| 3.5 | Dimensions | 14 |

| | | |
|----------|--|----|
| 4 | Electrical connection | |
| 4.1 | Wiring example Muting | 15 |
| 4.1.1 | Connector configuration Receiver, Transmitter & Cable - Muting Mode | 15 |
| 4.2 | Wiring example Cyclic operation | 16 |
| 4.2.1 | Connector configuration Receiver, Emitter & Cable - Cyclic operation | 16 |
| 4.3 | Sensor connection field | 17 |
| 5 | Set-up and maintenance | |
| 5.1 | Check before start-up | 17 |
| 5.2 | Maintenance | 17 |
| 5.3 | Regular check | 17 |
| 5.4 | Half-yearly inspection. | 17 |
| 5.5 | Cleaning | 17 |
| 6 | Diagnostic | |
| 6.1 | LED status information. | 18 |
| 6.2 | Fault diagnostic | 19 |
| 6.3 | Extended diagnostic. | 19 |
| 7 | Disassembly and disposal | |
| 7.1 | Disassembly. | 19 |
| 7.2 | Disposal | 19 |
| 8 | Appendix | |
| 8.1 | Contact. | 19 |
| 8.2 | EC Declaration of conformity | 20 |

1. About this document

1.1 Function

This operating instructions manual provides all the information you need for the mounting, set-up and commissioning to ensure the safe operation and disassembly of the safety switchgear. The operating instructions must be available in a legible condition and a complete version in the vicinity of the device.

1.2 Target group: authorised qualified personnel

All operations described in this operating instructions manual must be carried out by trained specialist personnel, authorised by the plant operator only.

Please make sure that you have read and understood these operating instructions and that you know all applicable legislations regarding occupational safety and accident prevention prior to installation and putting the component into operation.

The machine builder must carefully select the harmonised standards to be complied with as well as other technical specifications for the selection, mounting and integration of the components.

1.3 Explanation of the symbols used



Information, hint, note:

This symbol is used for identifying useful additional information.



Caution: Failure to comply with this warning notice could lead to failures or malfunctions.

Warning: Failure to comply with this warning notice could lead to physical injury and/or damage to the machine.

1.4 Appropriate use

The products described in these operating instructions are developed to execute safety-related functions as part of an entire plant or machine. It is the responsibility of the manufacturer of a machine or plant to ensure the correct functionality of the entire machinery or plant.

The safety switchgear must be exclusively used in accordance with the versions listed below or for the applications authorised by the manufacturer. Detailed information regarding the range of applications can be found in the chapter "Product description".

1.5 General safety instructions

Additional measures could be required to ensure that the electro-sensitive device does not present a dangerous breakdown, when other forms of light beams are available in a special application (e.g. use of wireless control devices on cranes, radiation of welding sparks or effects of stroboscopic lights).

The user must observe the safety instructions in this operating instructions manual, the country-specific installation standards as well as all prevailing safety regulations and accident prevention rules.



Further technical information can be found in the Schmersal catalogues or in the online catalogue on the Internet: www.schmersal.net.

The information contained in this operating instructions manual is provided without liability and is subject to technical modifications.



The entire concept of the control system, in which the safety component is integrated, must be validated to EN ISO 13849-2.

There are no residual risks, provided that the safety instructions as well as the instructions regarding mounting, commissioning, operation and maintenance are observed.

1.6 Warning about misuse



In case of inadequate or improper use or manipulations of the safety switchgear, personal hazards or damages to machinery or plant components cannot be excluded. The relevant requirements of the standards EN ISO 13855 (successor of EN 999) & EN ISO 13857 must be observed.

1.7 Exclusion of liability

We shall accept no liability for damages and malfunctions resulting from defective mounting or failure to comply with this operating instructions manual. The manufacturer shall accept no liability for damages resulting from the use of unauthorised spare parts or accessories.

For safety reasons, invasive work on the device as well as arbitrary repairs, conversions and modifications to the device are strictly forbidden; the manufacturer shall accept no liability for damages resulting from such invasive work, arbitrary repairs, conversions and/or modifications to the device.

2. Product description

2.1 Ordering code

This operating instructions manual applies to the following types:

SLC 425I-E/R^①-②-RFBC

| No. | Option | Description |
|-----|--------|--|
| ① | xxxx | Protection field heights in mm available lengths: 0170, 0250, 0330, 0410, 0490, 0570, 0650, 0730, 0810, 0890, 0970, 1050, 1130, 1210, 1290, 1370, 1450, 1530*, 1610*, 1690*, 1770* |
| ② | 14, 30 | Resolution 14 mm, 30 mm |

Note

* only for resolution 30 mm



Only if the information described in this operating instructions manual are realised correctly, the safety function and therefore the compliance with the Machinery Directive is maintained.

2.2 Special versions

For special versions, which are not listed in the order code below 2.1, these specifications apply accordingly, provided that they correspond to the standard version.

2.3 Scope of delivery and accessories

Accessories included in delivery

Mounting kit MS-1030

The kit comprises 4 rotating mounting angles and 16 mounting screws for fixing to the end caps.

Test rod PLS

The test rod is used for testing the protection field.

2.3.1 Optional accessories

Centre fixing MS-1051

Consisting of 2 steel angles, 4 fixing screws and 4 T-slot nuts

Connecting cable for transmitter

| Item number | Designation | Description | Length |
|-------------|-------------|------------------------------|--------|
| 1207741 | KA-0804 | Female connector M12, 4-pole | 5 m |
| 1207742 | KA-0805 | Female connector M12, 4-pole | 10 m |
| 1207743 | KA-0808 | Female connector M12, 4-pole | 20 m |

Connecting cable for receiver

| Item number | Designation | Description | Length |
|-------------|-------------|------------------------------|--------|
| 1207728 | KA-0904 | Female connector M12, 8-pole | 5 m |
| 1207729 | KA-0905 | Female connector M12, 8-pole | 10 m |
| 1207730 | KA-0908 | Female connector M12, 8-pole | 20 m |

BUS converter NSR-0801

Converter for parametrization and diagnostics. Detailed information can be found in the operating instructions manual of the NSR-0801. Included in delivery: integrated connecting cable, PC-software USB 2.0 connection (L x W x H, 122 x 60 x 35 mm), indications of measurements without cable

MSD4 Vibration damper

Kit comprising: 8 vibration dampers 15 x 20 mm, 8 x M5 socket head cap screws, 8 spring washers.

The MSD4 vibration damper kit must be used for damping vibrations and oscillations on the safety light curtain SLC 425 I. For applications with higher mechanical stresses, e.g. presses, punching machines, we recommend the MSD4 kit. In this way, the availability of the safety light curtain SLC 425 I is increased.

2.4 Destination and use

The SLC 425I is a non-contact, self-testing safety guard, which is used for the protection of hazardous points, hazardous areas and machine accesses. If one or more light beams are interrupted, the hazardous movement must be stopped.



The user must evaluate and design the safety chain in accordance with the relevant standards and the required safety level.

2.5 Technical data

| | |
|---|--|
| Standards: | EN 61496-1; CLC/TS 61496-2; EN ISO 13849; EN 62061 |
| Material of the enclosure: | Aluminium |
| Enclosure dimensions: | ø 49 mm |
| Number of beams: | 2 - 144 Beams |
| Protection field heights: | 170 – 1450 mm, Resolution 14 mm (170, 250, 330, 410, 490...), 170 – 1770 mm, Resolution 30 mm (170, 250, 330, 410, 490...) |
| Detection sensitivity for test bodies: | 14 mm, 30mm |
| Range of the protection field: | 0.3 up to 7.0 m; (Resolution 14 mm), 0.3 up to 10.0 m; (Resolution 30 mm) |
| Response time: | 1 - 48 L = 15 ms, 49 - 144 L = 25 ms without beam coding A, 1 - 48 L = 20 ms, 49 - 144 L = 32 ms with beam coding A |
| Rated operating voltage: | 24 VDC ±10% (PELV) supply unit to EN 60204 (power drop > 20 ms) |
| Operating current: | 400 mA max. + 0.5 A (OSSD load + output signal quality load) |
| Wave length of the sensor: | 880 nm |
| Safety outputs (OSSD1, OSSD2): | 2 x PNP-type semi-conductor, short-circuit proof |
| Switching voltage HIGH ¹⁾ : | 15 ... 28,8 V |
| Switching voltage LOW ¹⁾ : | 0 ... 2 V |
| Switching current: | 0 ... 500 mA |
| Leakage current ²⁾ : | 1 mA |
| Load capacity: | 2 µF |
| Load inductance: | 2 H |
| Admissible conduction resistance between OSSD and load: | 2.5 Ω |
| Supply cable: | 1 Ω |
| Contact control (EDM) | |
| Input voltage HIGH (inactive): | 17 ... 29 V |
| Input voltage LOW (active): | 0 ... 2,5 V |
| Input current HIGH: | 3 ... 10 mA |
| Input current LOW: | 0 ... 2 mA |
| Input restart interlock (manual reset) | |
| Input voltage HIGH (active): | 17 ... 29 V |
| Input voltage LOW (inactive): | 0 ... 2,5 V |
| Input current HIGH: | 3 ... 10 mA |
| Input current LOW: | 0 ... 3 mA |
| Function: | Start and restart interlock (manual reset), contactor control, fixed and floating beam blanking, muting, cyclic operation 1 to 8 cycles |
| Muting lamp output | |
| Voltage: | 24 VDC |
| Current: | 500 mA |
| Signal times | |
| Contact control: | 50 ... 500 ms, einstellbar |
| Restart interlock (manual reset): | 50 ms ... 1.0 s signal transmission in case of trailing edge |
| Start interlock: | 250 ... 1500 ms, adjustable |
| LED indications transmitter: | Transmitting, status |
| LED indications receiver: | OSSD ON, OSSD OFF, restart, signal reception, blanking, multifunction |
| Connection: | M12 Connector plug with metal thread, receiver 8-pole, transmitter, 4-pole (male), Muting sensors 2 pc. M8 3-pole, Muting lamp M8 3 pole |
| Ambient temperature: | -10° C ... +50° C |
| Storage temperature: | -25° C ... +70° C |
| Interface: | Diagnostics and function setting |
| Protection class: | IP67 (IEC 60529) |
| Resistance to vibrations: | 10 ... 55 Hz to IEC 60068-2-6 |
| Resistance to shock: | 10 g; 16 ms; to IEC 60068-2-29 |
| Year of construction: | as of 2010 version 1.0 |

¹⁾ To IEC 61131-2

²⁾ In case of failure, the leakage current at the most flows to the OSSD cable. The downstream control element must recognise this state as LOW. A safety PLC must detect this state.

2.6 Response time (reaction time)

The response time of the safety light curtain SLC 425 I depends on the height of the protected field, the resolution, the number of light beams and the beam coding.

| Resolution 14 mm | | | | |
|-----------------------|----------------|--------------------|---------------------------------------|-------------|
| Protected height [mm] | Beams [Number] | Response time [ms] | Response time with beam coding A [ms] | Weight [kg] |
| 170 | 16 | 15 | 20 | 1.0 |
| 250 | 24 | 15 | 20 | 1.3 |
| 330 | 32 | 15 | 20 | 1.6 |
| 410 | 40 | 15 | 20 | 1.9 |
| 490 | 48 | 15 | 20 | 2.1 |
| 570 | 56 | 25 | 32 | 2.4 |
| 650 | 64 | 25 | 32 | 2.6 |
| 730 | 72 | 25 | 32 | 2.9 |
| 810 | 80 | 25 | 32 | 3.2 |
| 890 | 88 | 25 | 32 | 3.5 |
| 970 | 96 | 25 | 32 | 3.7 |
| 1050 | 104 | 25 | 32 | 4.0 |
| 1130 | 112 | 25 | 32 | 4.3 |
| 1210 | 120 | 25 | 32 | 4.6 |
| 1290 | 128 | 25 | 32 | 4.7 |
| 1370 | 136 | 25 | 32 | 5.1 |
| 1450 | 144 | 25 | 32 | 5.3 |

| Resolution 30 mm | | | | |
|-----------------------|----------------|--------------------|---------------------------------------|-------------|
| Protected height [mm] | Beams [Number] | Response time [ms] | Response time with beam coding A [ms] | Weight [kg] |
| 170 | 8 | 15 | 20 | 1.0 |
| 250 | 12 | 15 | 20 | 1.3 |
| 330 | 16 | 15 | 20 | 1.6 |
| 410 | 20 | 15 | 20 | 1.9 |
| 490 | 24 | 15 | 20 | 2.1 |
| 570 | 28 | 15 | 20 | 2.4 |
| 650 | 32 | 15 | 20 | 2.6 |
| 730 | 36 | 15 | 20 | 2.9 |
| 810 | 40 | 15 | 20 | 3.2 |
| 890 | 44 | 15 | 20 | 3.5 |
| 970 | 48 | 15 | 20 | 3.7 |
| 1050 | 52 | 25 | 32 | 4.0 |
| 1130 | 56 | 25 | 32 | 4.3 |
| 1210 | 60 | 25 | 32 | 4.6 |
| 1290 | 64 | 25 | 32 | 4.8 |
| 1370 | 68 | 25 | 32 | 5.1 |
| 1450 | 72 | 25 | 32 | 5.3 |
| 1530 | 76 | 25 | 32 | 5.6 |
| 1610 | 80 | 25 | 32 | 5.9 |
| 1690 | 84 | 25 | 32 | 6.2 |
| 1770 | 88 | 25 | 32 | 6.4 |

2.7 Safety classification

| | |
|-------------------|---------------------------|
| Standards: | EN ISO 13849, EN 62061 |
| PL: | up to e |
| Control category: | up to 4 |
| PFH value: | $7.42 \times 10^{-9} / h$ |
| SIL: | up to 3 |
| Service life: | 20 years |

2.8 Functions

The system consists of a receiver and a transmitter. For the described functions, no further switching elements are required. For the diagnostics and function selection, a user-friendly PC-software is offered as accessory.

For the connection to a PC, the NSR-0801 BUS converter is required (not included in delivery).

The system for the version SLC 425 I has the following features:

- Start interlock
- Restart interlock (manual reset)
- Contactor control EDM
- Beam coding
- Blanking of fixed protection field areas
- Blanking of movable protection field areas
- Muting
- Cyclic operation

2.8.1 Factory setting

The SLC 425I system features many functions without additional devices. The following table gives an overview of the possible functions and the factory settings configuration.

| Function | Factory setting | Configuration |
|----------------------------------|-----------------|---|
| Restart interlock (manual reset) | not active | External wiring |
| Contactor control | not active | With BUS converter NSR-0801 and PC-software |
| Start interlock | not active | With BUS converter NSR-0801 and PC-software |
| Beam coding | not active | With BUS converter NSR-0801 and PC-software |
| Blanking fixed/variable | not active | With BUS converter NSR-0801 and PC-software |
| Muting | active | With BUS converter NSR-0801 and PC-software |
| Cyclic operation | not active | With BUS converter NSR-0801 and PC-software |

2.8.2 Restart interlock (manual reset)

The restart interlock prevents an automatic enabling of the outputs (OSSD's ON state) after switch-on of the operating voltage or an interruption of the protection field. The system switches the outputs only to ON state, when an external command device (restart button) generates an enabling signal at the restart input (receiver).



The command devices (enabling button) must be installed outside of the hazardous area. The operator must have a clear view on the hazardous area when actuating the enabling button.



In supply condition, the restart interlock is not active. You must select an operating mode in order for the outputs OSSD's to be enabled. If no type of protection is selected, you will obtain the following signalisation through the LED status indication in the receiver:
LED OSSD OFF (red) + LED restart (yellow) flashing

2.8.3 Contactor control (EDM)

The contactor control monitors the controlled switching elements (auxiliary contacts of the contactors) of both outputs. This monitoring is realised after each interruption of the protection field and prior to the restart (enabling) of the outputs. In this way, malfunctions of the relays are detected, e.g. contact welding or contact spring breakage.

If the light curtain detects a malfunction of the switching elements, the outputs are locked. After fault rectification, the operating voltage must be once switched off and back on (power reset).



The contactor control is not activated upon delivery. This function is activated by means of the NSR-0801 BUS converter and a PC or laptop.
The "contactor control" function is not available in the operating mode muting.

2.8.4 Start interlock

The start interlock prevents an automatic start of the machine when the supply voltage is switched on. After enabling of the start interlock - by the one-time interruption of the protection field -, this protective function is deactivated until the next power reset.



The start interlock is not activated upon delivery. This function is activated by means of the NSR-0801 BUS converter and a PC or laptop.

2.8.5 Beam coding

The beam coding of the safety light curtain must be adjusted, when systems operating in each other's vicinity and a set-up as shown in the image below (no interference) is impossible. When supplied, the beam coding is not active. With beam coding A, a receiver can distinguish the beams of the transmitter with the same beam coding A, which are destined to this particular receiver, from foreign beams. The beam coding A must be set for each sensor (receiver and transmitter) individually. The function is activated by means of the NSR-0801 BUS converter and a PC or laptop.

If adjacent systems are operated without beam coding, the user is at risk.

no interference

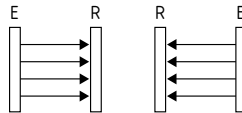

Interference: beam coding required!

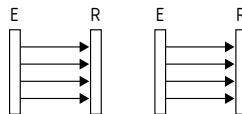

- The beam coding increases the safety and avoids mutual interference of adjacent systems.
- The beam coding increases the immunity against optical interference (e.g. sun light, welding sparks).
- The beam coding A is permanently shown by the transmitter and the receiver by means of flashing LED's (refer to LED status information).



On adjacent systems, the beam coding A must be used. The response time of the system is increased when beam coding A is used. To this end, the safety distance must be adjusted to the hazardous movement. Refer to chapter Response time.

2.8.6 Blanking

Fixed blanking

The SLC 425 I can blank stationary parts in the protection field. Multiple protection field areas can be blanked. If small changes are made within the fixed blanking area, each time 1 beam can be additionally blanked to increase the tolerance.

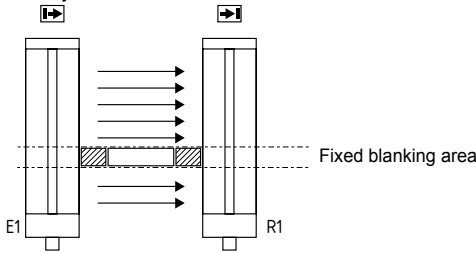

The range of the fixed blanking can be arbitrarily chosen in the protection field.

The first beam line, which realises the optical synchronisation and is located immediately behind the diagnostic window, cannot be blanked.

The area of the fixed blanking must not be modified after the teach-in process. Any change of the area or removal of the part from the protection field will be detected by the system. As a result, the outputs are disabled (locked). This locking can be neutralised by executing a new teach-in process in accordance with the actual beam interruptions.



- The remaining lateral areas must be protected against intrusion by means of mechanical covers.
- The lateral covers must be fixed with the object. Partial covers are not authorised.
- After the fixed blanking, the protection field must be tested by means of the test rod.
- The restart interlock function of the safety light curtain or the machine must be activated.

The standard IEC/TS 62046 includes information, which describes possibly required additional measures to prevent a person from reaching a hazard through the blanking areas of a protection field.



The function is activated by means of the NSR-0801 BUS converter and a PC or laptop. The activation of the function is signaled by the LED blanking flashing in the diagnostic window of the receiver.

Floating blanking

The SLC 425 I can blank movable parts in the protection field.

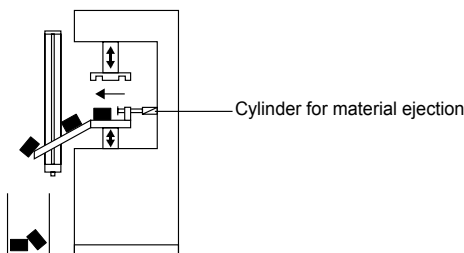

The function enables an arbitrary floating blanking of partial areas in the protection field.

The first beam, which is located immediately behind the diagnostic window, cannot be blanked.

The SLC 425I can blank one or more beams in the protection field. A combination of fixed and variable blanking is possible.

This function allows for an interruption of the protection height without the outputs being disabled in case of material movement in the protection field, e.g. material ejection or process-controlled material movement. This extension of the object detection increases the resolution. In this way, the physical resolution changes into an effective resolution. This effective resolution must be used to calculate the safety distance. This effective resolution must be used to calculate the safety distance. Calculation of the safety distance in accordance with the effective

resolution for the blanking of a maximum of 2 beams by means of formula (1), in case of more than 2 beams by means of formula (3) of the chapter "Determination of the safety distance"

The number of beams to be blanked is limited by the software.

In a system with a 14 mm physical resolution, the effective resolution is increased to 2 mm in case of a variable blanking of 34 beams. The effective resolution must be registered permanently and clearly visible onto the label affixed to the receiver.

Effective resolution

The effective resolution in case of activated blanking of floating beams can be found in the following table:

| Beams blanked | Physical Resolution | Effective resolution |
|---------------|---------------------|----------------------|
| 1 | 14 | 24 |
| 2 | 14 | 34 |
| 3 | 14 | 44 |
| 4 | 14 | 54 |
| 5 | 14 | 64 |
| 6 | 14 | 74 |
| 7 | 14 | 84 |
| 8 | 14 | 94 |

| Beams blanked | Physical Resolution | Effective resolution |
|---------------|---------------------|----------------------|
| 1 | 30 | 45 |
| 2 | 30 | 65 |
| 3 | 30 | 85 |
| 4 | 30 | 105 |



The function is activated by means of the NSR-0801 BUS converter and a PC or laptop. The activation of the function is signaled by the LED blanking flashing in the diagnostic window of the receiver.



The function is activated by means of the NSR-0801 BUS converter and a PC or laptop. The activation of the function is signaled by the LED blanking flashing in the diagnostic window of the receiver. The function "mobile blanking" is not available in the operating mode muting.



Perform a new calculation of the safety distance with the effective resolution. Adjust the safety distance in accordance with your calculation! After configuration, the protection field must be checked by a responsible person by means of a test rod; in addition to that, this person must compare the size of the blanked area to the object size and if necessary provide for additional covers or a larger distance of the safety guard with regard to the hazardous point. The standard IEC/TS 62046 includes information, which describes possibly required additional measures to prevent a person from reaching a hazard through the blanking areas of a protection field.

2.8.7 Testing

The system performs a complete self-test and safety test within 2 seconds after the operating voltage has been switched on. If the protection field is not interrupted, the system switches to the ON condition. In case of an error, the outputs at the receiver do not switch to the ON state. The LED OSSD OFF starts flashing, thus emitting an error message. Further indications can be found in the chapter Fault diagnostic. During operation, the system continuously executes a self-test. Safety-relevant faults are detected within the cycle time and cause the outputs to be switched off.

2.9 Operating mode muting

Adequate and appropriate application

The objective of the by-pass function is the safe distinction between material and the presence of a person in front of the hazardous area. To this effect, (2 or 4) additional sensors must be connected to provide for a safe distinction between persons and the material to be transported.



To activate and parameterise the muting function, the NSR-0801 BUS converter and the SLC4 PC software is required.

Special safety instructions for muting

All components must only be connected, wired and fitted by a specialist, who has sufficient electrical professional training and knowledge of the harmonised safety regulations.

Testing and start-up by a qualified person, who has professional knowledge as well as in particular knowledge of the harmonised legal and governmental regulations.

Instruction and training of the operators by an expert on the application.

After connection and fitting by an expert, the following instructions must be respected and observed:

- Set-up of the sensors to the operating instructions SLC 425I. The muting function must not be started by a person unintentionally accessing the hazardous area. The sensors must be set up so that a normal approach by a body part, e.g. foot, leg, arm, hand movement does not activate the muting mode.
- The selection of the operating parameters, e.g. simultaneity, muting time, operating mode, special functions, etc. must be adjusted to the application.
- The muting cycle must be started automatically after the command device is enabled and be controlled by at least two independent signals (sensors).
- The command device for the enabling and override function must be set up so that the operator has a clear view on the entire hazardous area. The mounting position must be selected so that the device cannot be actuated at the hazardous point.
- The muting state can be signalled through a muting lamp.



The muting function must only be used for automatic material transport to protect the accesses to the hazardous area. In this way, the material passes through the accesses and the protection field of the SLC 425I without disabling the outputs. This function is only authorised for the above-described application. For other applications, no warranty claims shall be accepted.

This document includes information for the adequate and proper by-passing of the protection field of an ESD and is reserved to persons, who have the necessary expertise and technical know-how. The users of this document must be able to adequately and correctly evaluate the risks involved in this operating mode.

This document does not provide all technical know-how, which is required in conjunction with this operating mode. To this effect, the harmonised governmental and legal provisions regarding the technical know-how must be observed.

Definitions:

| | |
|----------------|---|
| Muting: | specific intended brief by-passing of the outputs of an ESD in case of automatic material transport |
| Muting sensor: | sensor for the uniform recognition of material |
| Muting lamp: | the muting lamp signals the muting state |
| Override: | the function enables the material transport after an exceptional stop of the muting cycle |
| Belt stop: | the muting running time is stopped as long as the "belt stop" signal is active |

2.9.1 Muting sensors MS

The MS muting sensor can be a mechanical, capacitive, inductive or optoelectronic sensor. They have no particular requirements as fail-safety is regarded. The set-up must be executed tamper-proof. When reflexion light barriers are used, the sensors and reflectors must be arranged alternately to avoid mutual interference. When optoelectronic sensors are used, the switching outputs must be set to dark operation (sensor actuated = 24 VDC).

The sensors must be arranged so that the transported material part is detected without any interruption over the entire length. The sensors must detect the material, not the means of transport.

The distance of the sensors must not be too large, so that all activated muting sensors are actuated by the travelling material during a cycle. The simultaneity (max. 3 sec.) of the switching outputs must be observed.

A new muting process can only be started when the previous is terminated (all sensors not actuated).

A safety distance of at least 50 mm (belt speed $V < 2.0$ m/s) must be observed with regard to the protection field, in order to ensure a safe signal evaluation by the control system.

Installation of the muting sensors

If 4 muting sensors are used, the switching outputs of the muting sensors MS 1 and MS 3 as well as MS 2 and MS 4 must be wired in parallel. MS 1 and MS 3 are connected to the MS1/MC connector socket on the sensor connection plate. MS 2 and MS 4 to the MS 2 connector socket.

Sensor connection:

with 2 muting sensors

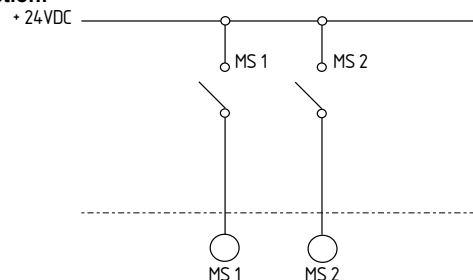

SLC 425I sensor connection

with 4 muting sensors

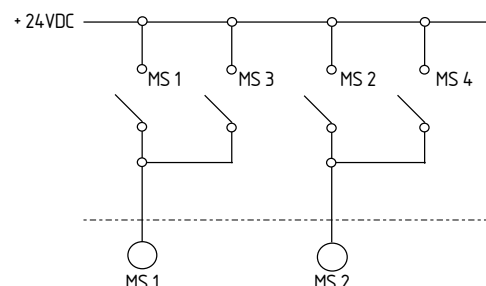

SLC 425I sensor connection



The muting sensors must be arranged so that any unintentional access or penetration of a person into the hazardous area is prevented. When positioning the muting sensors, the distance and the height must be chosen so that a clear distinction is made between material and a person!

2.9.2 Muting lamp

The operating mode "muting" can be signalled through an external muting lamp. This lamp must be connected to the sensor connection plate (ML) through a connection with a 3-pole connector socket. The muting lamp is not monitored! I.e. the electrical connection and the included illuminant are not checked by the control system of the SLC 425I.

The muting lamp signals the following operating modes:

| Muting lamp | Signal | Note |
|-------------|-------------------|-------------------------------------|
| ON | Continuous signal | Muting cycle active |
| OFF | | Muting cycle not active |
| Flashing | 2 Hz | Muting cycle error or override mode |

If the muting lamps are flashing, the following failures can be present:

- Muting cycle time exceeded
- Belt stopping time exceeded
- Sequence or simultaneity of the signal conditions of the MS not observed

Illuminant

For the muting lamp, a LED block with a lifetime of approx. 50 000 operating hours must be used as admissible illuminant. The utilisation of MK2 type muting lamps is recommended.

2.9.3 Signal sequence muting

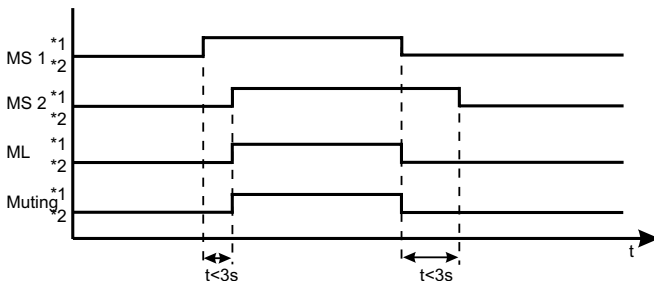

*1: active

*2: inactive

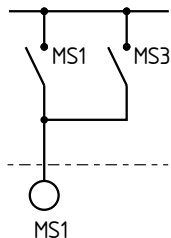

Sensor group 1

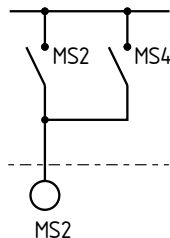

Sensor group 2

Parameter setting: muting mode with 2 sensor groups (4 muting sensors), direction detection 1, premature termination not active

The muting function is activated after first MS 1 (first sensor group) and subsequently MS 2 (second sensor group) is actuated by the material (direction detection 1). The material first actuates the protection field of the SLC 425I, after that MS 3 (first sensor group) and finally the MS 4 (second sensor group). The muting cycle is cancelled, when MS 3 (second sensor group) is no longer actuated.

2.9.4 Configuration of the muting function

The parameters for the muting mode are set by means of the PC software as of version: SLC 4 Kunde.exe
To this effect, the NSR-0801 BUS converter must be connected to the SLC 425I and a PC or laptop. Please use the NSR-0801 BUS converter manual for the connection.

Operating mode set-up for muting mode:

After the correct connection of the muting sensors and the NSR-0801, the following parameters must be set by means of the PC software in the "muting function" menu field in accordance with your application.

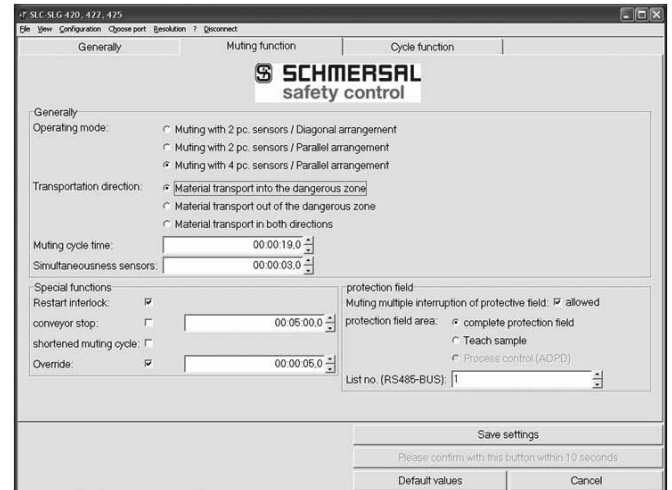

Operating mode and transport direction

First choose the operating mode and the transport direction (set-up and number of the muting sensors).

- Muting with 2 sensors, diagonal arrangement

Muting variant with 2 crosswise arranged muting sensors transport direction: material transport in both directions (factory setting), selectable options: belt stop, reduced muting cycle, override, protection field area

- Muting with 2 sensors, parallel arrangement

Muting variant with 2 muting sensors transport direction: outward travelling (leaving the hazardous area), reduced muting cycle (factory setting) selectable options: belt stop, override, protection field area



The use of 2 parallel arranged sensors is only authorised for outward material transport, i.e. the transport of material out of the hazardous area. The muting sensors must be installed inside the hazardous area.

- Muting with 4 sensors, parallel arrangement

Muting with each time 2 symmetrically arranged sensors before and after the protection field of the SLC 425I. Transport direction: material transport in two directions selectable; selectable options: belt stop, reduced muting cycle, override, protection field area

Muting cycle time

The muting cycle time is the time expiring between the moment of activation of the muting until the inward or outward material transport in the hazardous area is completely terminated.

The muting cycle time depends on the length of the material, the belt speed and the sensor arrangement.

The time must be defined so that the material can travel by all sensors within the muting cycle time (enabling of all muting sensors).

Before a new muting cycle can be initiated, all sensors must be clear (no actuation).

The muting cycle time can be set from a few seconds up to multiple hours. Longer muting cycle times can result in hazardous operating conditions.

The muting cycle time must take variations in the belt speed as well as position and length tolerances of the material into consideration.

Reduced muting cycle

A normal muting cycle is terminated by a muting sensor in the following way:

- Muting with 2 sensors, diagonal arrangement after enabling of muting sensor MS 2
- Muting with 4 sensors, parallel arrangement after enabling of muting sensor MS 3

For very long muting cycle times, this results in a time window with bridged protection field, as long as the material is located between the protection field and the muting sensor MS 2/MS 3.

By activating the function, the muting cycle is shortened/reduced. The muting cycle is terminated, when the material has travelled by the protection field of the SLC 425I (protection field clear).

This field is always activated when applied with 2 parallel arranged muting sensors. For applications with 2 diagonally arranged MS or 4 parallel arranged MS, the function can be activated by means of the software.

A new muting cycle can only be started, when all muting sensors are no longer actuated.

Simultaneity of the sensors

The timeframe between the first and the second muting sensor is monitored. In this way, a uniformly-shaped transport good can be distinguished from other switching times (passing by of a person) in case of an adequate arrangement of the muting sensors.

The simultaneity setting must take variations in the belt speed, as well as the position and length tolerances of the material into consideration. The simultaneity of the sensors can be set between 1 to 3 seconds.

Setting the special functions is recommended. In this way, the protective function and the availability of the muting application is increased.

Restart interlock (manual reset)

The restart interlock prevents an automatic belt start after voltage interruption or material jamming.

The restart interlock must be wired as shown in the wiring diagram (chapter 4). The function is active upon delivery.

The command device must be installed outside of the hazardous area, so that the operator has a clear view on the area.

The command device must be actuated after any interruption of the voltage or the protection field or fault of the muting cycle. Enabling is only possible, when all muting sensors are not actuated. The signalling for the actuation of the command device is realised by a status LED on the receiver.

The function can be deactivated by removing the check mark in the software. By doing this the following operating condition is created: the outputs OSSD's are released, when all light beams and the muting sensors are not interrupted (light path clear). The same applies after an interruption of the voltage supply. A release through the command device is only required after a malfunction (muting cycle fault). The owner then must secure this function through the application.



The deactivation of the "restart interlock" function can trigger an automatic muting cycle. In this way, persons can access/penetrate into the hazardous area. Persons within the hazardous area are exposed to severe injuries.

Belt stop

The function can extend the muting cycle time in case of a belt stop or material jamming, thus preventing a premature shutdown. In this way, the muting function can be extended until the failure/belt stop is rectified. After that, the normal muting cycle can be terminated.

The machine control makes the belt stop input available as signal.

The function is activated by switching on 24 VDC at pin 8 of the receiver. A status change of the muting sensors (switching output) when the function is active, causes the muting function to be switched off.

The function is deactivated upon delivery. The belt stop time can be set from 1 to 30 minutes.

Override

This function enables bridging the outputs of the SLC 425I in case of failure (voltage interruption, material jamming). The function is limited in time and exclusively reserved to the elimination of the material jamming (muting sensor or protection field actuated).

The function is activated by means of the command device (restart interlock enabling).

The command device must be actuated in the sequence ON-OFF-ON.

The time-related sequence for the start (ON-OFF-ON) with a minimum duration of 100 ms up to the maximum duration of 1.5 sec. must be observed. If the material jamming is eliminated (protection field and muting sensors no longer actuated), the outputs of the SLC 425I are locked. To start a new muting cycle, the command device (enabling of the restart interlock) must be actuated one time (ON-OFF).

The muting lamp starts flashing (2 Hz) to signal the interruption of the muting cycle. The function is not activated upon delivery.

Multiple interruption of the protection field during the muting cycle

This function increases the availability of the system in case of different material qualities on one pallet.

Without the function "multiple interruption of the protection field", the protection field is monitored during the active muting cycle and any non-actuation (no beam interrupted) immediately cancels the muting cycle. This error function is triggered when all active beams of the protection field are not actuated for a period of time of over 20 ms e.g. due to an irregular loading of the material on the carrier.

If the function is activated, no shutdown is triggered if the beams are not actuated during the muting cycle. The correct termination is realised by the configuration or the muting sensors. The combination with the parameter setting "reduced muting cycle" is not possible. These restrictions are marked in the software and must be observed.

Activating the protection field

During a muting cycle, the entire protection field height of the SLC 425I is bridged. This causes the risk that persons located on or beside the material can get into the hazardous area.

The risk can be avoided by activating the remainder of the protection field, if the conveyed material has a throughout identical height. In this way, the presence of persons within the active protection field height is detected!

Procedure:

Position the material onto the carrier so that the protection field of the SLC 425I is actuated. If the material height is slightly varying, the carrier can be slightly increased during the teaching process to avoid false triggering.

Now activate the teach sample field in the software. The menu automatically switches to the beam view.

The beams interrupted by the material are represented in red. The teaching process is terminated with a mouse click on the "teach" field. You will return to the main menu "muting".

Changing the protection field area

If the protection field height parameterised by means of the teach process needs to be changed, the saved value must be deleted and reparameterised.

Procedure:

Activating the entire protection field (the previous value is deleted)

Activating the teach sample (change to beam view)

Saving the new value (teach process) with teach



Mounting:

The first light beam (near the diagnostic window) must not be interrupted! I.e. observe the downward cable connection.

2.9.5 Saving the data

After the reconfiguration, the data to be saved are prepared by selecting the button "Save settings". To avoid unintentional saving of the data, every intentional save procedure must be confirmed by clicking an additional button

"Confirm within 10 seconds by clicking this button"

within 10 seconds

If the change is confirmed within 10 seconds, the new configuration is transferred to the SLC 425I safety light curtain. If it is not confirmed within this timeframe, the settings that were saved before the change was made will be maintained without any change.

After the data transmission, the following confirmation is displayed. You are simultaneously asked to save the configuration data in the form of a text file.



This saving procedure is recommended so that configuration changes can be reproduced at a later moment. Click the (yes) button with your mouse to confirm.

You now can save the configuration setting onto your PC or laptop.

2.9.6 Muting applications

Arrangement of the muting sensors

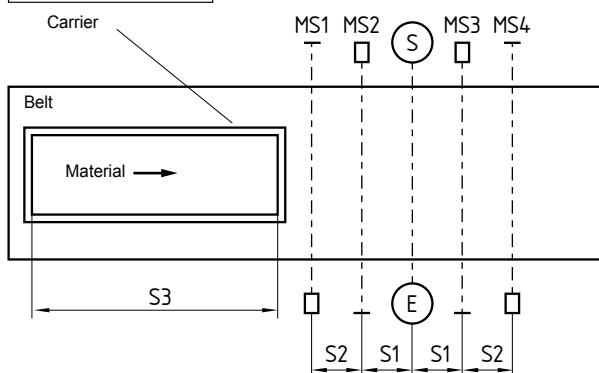
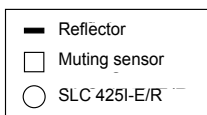
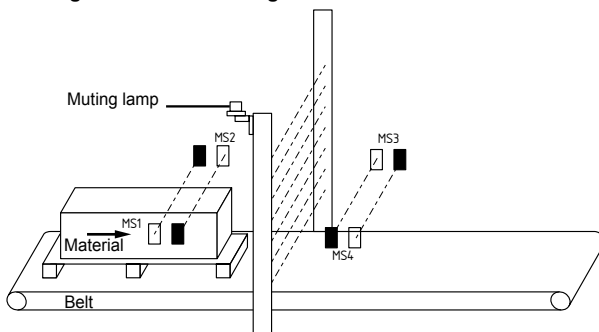

S1 = distance of the inner MS to SF
 S2 = distance between two MS
 S3 = material length
 MS 1 = muting sensor 1
 MS 2 = muting sensor 2
 MS 3 = muting sensor 3
 MS 4 = muting sensor 4
 BWS = ESD (electro-sensitive safety device)
 S = transmitter; E = receiver
 VB = belt speed (m/s)

Minimum distances muting sensors

For the evaluation of the signals (MS) in the control system, a minimum distance is required for the muting sensors.

The minimum signal length between the sensors, which are fitted closest to the SLC 425I, must be at least 50 ms. This corresponds to a minimum distance of 100 mm at a belt speed of 2.0 m/s.

The minimum signal length of the outer sensors must be over 50 ms.

The signal propagation delay between the muting sensors may be 3 seconds at the most (depending on the chosen setting).

The mounting distance of the inner sensors to the protection field of the SLC 425I must be chosen as small as possible.

The sensors (transmitter/receiver) of the SLC 425I must be fixed as close as possible to the conveyed material to avoid the creation of gaps. Otherwise, there is a risk that persons can slip between the material and the MS arrangement into the hazardous area during the muting cycle.

In case of different material widths, the gap between the sensors (transmitter/receiver) of the SLC 425I and the material must be protected with an additional cover.

Muting with 2 sensors, parallel arrangement

The arrangement shows the muting application with two parallel arranged muting sensors. This arrangement enables the material to be transported in only one direction, out of the hazardous area.

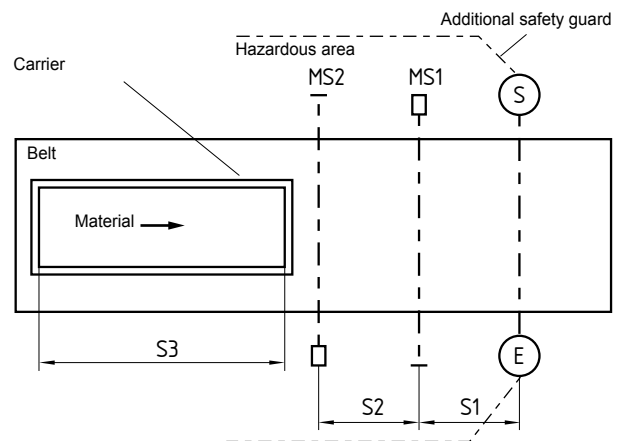

S1 = distance MS 1 to SF
 S2 = distance MS 1 to MS 2
 S3 = material length
 MS 1 = muting sensor 1
 MS 2 = muting sensor 2
 S = transmitter; E = receiver
 VB = belt speed (m/s)
 SF = protection field
 $S3 > S1 + S2$
 $S1 = \text{belt speed VB (m/s)} * 0.05 \text{ s}$

The muting cycle is as follows: MS2- MS1- SF- end

Selectable options: Belt stop, override, protection field area

Factory setting Shortened muting cycle, i.e. the muting cycle is terminated when the protection field is released.



This arrangement is only authorised when the muting sensors are installed inside the hazardous area.

Muting with 2 sensors, diagonal arrangement

The arrangement shows the muting application with two diagonally (crosswise) arranged muting sensors. This arrangement enables the material to be transported in both directions.

Schematic representation

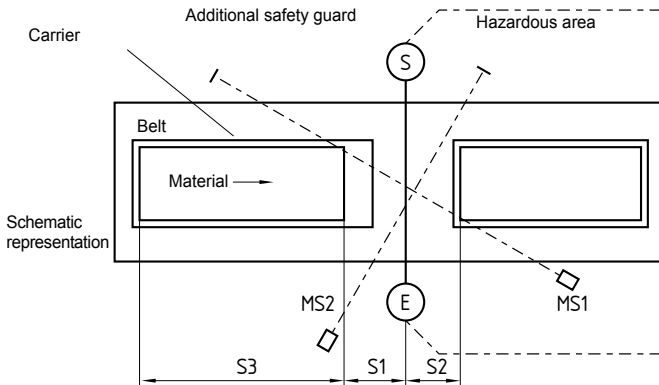

S1 = distance MS 1 to SF
 S2 = distance MS 2 to SF
 S3 = material length
 MS 1 = muting sensor 1
 MS 2 = muting sensor 2
 S = transmitter; E = receiver
 VB = belt speed (m/s)
 SF = protection field
 $S3 > S1 + S2$
 $S1 = \text{belt speed VB (m/s)} * 0.05 \text{ s}$



The intersection of the muting sensors must always be within the hazardous area!

In the schematic diagram, the arrangement of the muting sensors is represented with a larger distance to enable a uniform identification of the sensor sequence. Please observe the smallest possible distance of the MS to the transported material.

The distance of MS 1 and MS 2 to the protection field of the SLC 425I must be chosen as small as possible as well.

The muting cycle is as follows: MS1- MS2- SF- MS2 - end
Selectable options: Belt stop, override, shortened muting cycle, protection field area
Factory setting Material transport in both directions

The muting sensors must be arranged so that a uniform sequence of the muting sensors is ensured.
 The intersection of both muting sensors always must be located inside the hazardous area.

Muting with 4 sensors, parallel arrangement

The arrangement shows the muting application with four parallel arranged muting sensors. This arrangement enables the material to be transported in both directions.

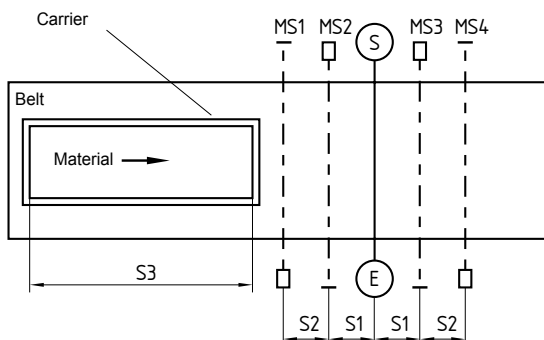

S1 = distance of the inner MS to SF
 S2 = distance between two MS

S3 = material length
 MS 1 = muting sensor 1
 MS 2 = muting sensor 2
 MS 3 = muting sensor 3
 MS 4 = muting sensor 4
 S = transmitter; E = receiver
 VB = belt speed (m/s)
 SF = protection field
 $S3 > 2(S1 + S2)$
 $S1 = \text{belt speed VB (m/s)} * 0.05 \text{ s}$

The muting cycle is as follows: MS1- MS2- SF- MS 3 end MS4- MS3- SF- MS 2 end

Selectable options: Belt stop, override, shortened muting cycle, protection field area

Factory setting Material transport in both directions

The muting figure with each time 2 muting sensors shows a symmetrical arrangement before and after the protection field of the SLC 425I.

2.10 Operating mode cyclic operation

1 to 8 cycles are available. They are selected by means of the PC software and the NSR-0801. The factory setting is two-cycle operation and a 30 sec. cycle time.

Adequate and appropriate application

The cyclic operation must be used for machines with short processing times. The function enables an automatic work sequence by the cyclic feed and removal of parts in the protection field of the SLC 425I. The automatic sequence is time-monitored. In this way, up to 8 work-pieces (8 interventions in the protection field) can be processed at the same time.



This function is only authorised for the above-described application. For other applications, no warranty claims shall be accepted. No liability shall be accepted either when the following mounting conditions, safety instructions and correct parameter setting are not respected and observed.

Operating principle cyclic operation

The interventions of the operator (N) (1) in the protection field during the first machine cycle are not evaluated. The start condition for the first cycle is available after the actuation of the start button (2) and both operator interventions (3) for the 2-cycle operation. As a result of the operator interventions, the OSSD outputs (3) are enabled. The downward movement of the machine (hazardous machine movement) takes place. During the hazardous work cycle, all operator interventions will cause the outputs to be disabled. As soon as the hazardous movement of the machine is terminated, the machine contact (4) is opened and the outputs (4) are disabled. The signal length of the machine contact is monitored and must be present for at least 50ms. Subsequent operator interventions (5) will be counted in the next cycle. The correct number of operator interventions (5) will start a new work cycle, whereby the outputs (6) are re-enabled. The machine contact (7) stops the hazardous movement and disables the OSSD outputs (7) again.

Schema: two-cycle operation

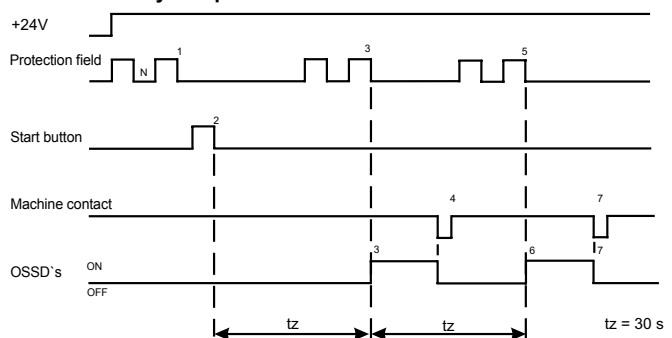

Machine contact = signal hazardous movement of the machine is terminated

Machine contact

The machine contact is a signal, which is transmitted from the machine control to the SLC 425I. This contact is used for the cycle reset and enables an immediate intervention in the protection field. The signal is integrated in the control system of the SLC 425I with the status information - The hazardous movement is terminated!

The signal is preferably provided after the end of the downward movement (UT) to the switching diagram, when no hazardous movement is produced during the upward movement.

The machine contact suffices as individual contact. The machine contact has a signal length of at least 50 ms and 1s at the most. If the machine contact is not closed back within the time window (ON signal), no new cycle will take place.

The machine contact must be connected to the sensor connection field of the SLC 2I (input MS425/MC) by means of a separate cable (at least 1 poles).

Start conditions

First actuate the start button and then execute the operator interventions.

The start condition must be executed:

- prior to the first machine cycle after the supply voltage is switched on,
- false intervention in the protection field,
- cycle time exceeded,
- false machine contact or time window exceeded

Further machine cycles are only controlled by the operator interventions.

The time between the operator intervention and the actuation of the start button may be max. 30 sec. at the most.

Cycle time

The cycle time is the time between two successive cycles, i.e. interventions in the protection field (material feed and removal). This time must be set by the machine installer in accordance with the machine running time. For this time setting, a tolerance must be observed, in order for to allow for the material to be processed to be fed and removed at a normal operating speed.

The cycle time is reset by actuating the enabling command device or by starting a new work process.

The cycle time can be set by means of the PC software. Upon delivery, the time is set to 30 sec.

The value range is defined from 1 sec. to 30 sec. with an increment of 1 sec.

Operator interventions

The operator interventions in the protection field are counted and time-monitored in accordance with the setting. To prevent unintentional operator interventions, the minimum time of 100 ms must be observed for an intervention in the protection field (beam interrupted and cleared).

Configuration cyclic operation

The parameters for the cyclic operation are set by means of the PC software as of version: SLC 4 Kunde.exe

To this effect, the NSR-0801 BUS converter must be connected to the SLC 425I and a PC or laptop. Please use the NSR-0801 BUS converter manual for the connection.

Click with your mouse on the "cyclic function" field to select the cyclic function (upon delivery, the muting function is activated. Therefore, the muting function must be deactivated).

After selection of the cyclic function, the following parameters must be set in the menu window:

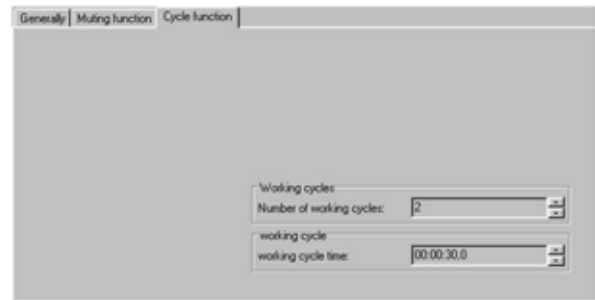

Cycles

The number of required operator interventions in the protection field for the material feed or removal must be selected. Operator interventions of 1 to 8 cycles can be chosen. The number can be set by means of the arrow keys.

Cycle

The cycle time must be set as described above.

Saving the data

To save the data for the SLC 425I safety light curtain, please refer to chapter 2.9.5 (Muting description)

3. Mounting

3.1 General conditions

The following guidelines are provided as preventive warning notices to ensure a safe and appropriate handling of the SLC 425I. These guidelines are an essential part of the safety instructions and therefore must always be observed and respected.



The SLC 425I must not be used on machines, which can be stopped electrically in case of emergency.

The safety distance between the SLC 425I and a hazardous machine movement must always be observed and respected. Additional mechanical safety guards must be installed so that the operator has to pass by the protection field to reach the hazardous machine parts.

The SLC 425I must be installed so that the personnel always must be within the detection zone when operating the machine. An incorrect installation can lead to serious injuries.

Never connect the outputs to +24VDC. If the outputs are wired to +24VDC, they are in ON state, as a result of which they are unable to stop a hazardous situation occurring on the application/machine.

The safety inspections must be conducted regularly.

The SLC 425I must not be exposed to inflammable or explosive gasses.

The connecting cables must be connected in accordance with the installation instructions. The fixing screws of the end caps and the mounting angle must be firmly tightened.

Additional measures could be required to ensure that the electro-sensitive device does not present a dangerous breakdown, when other forms of light beams are available in a special application (e.g. use of wireless control devices on cranes, radiation of welding sparks or effects of stroboscopic lights).

3.2 Protection field and approach

The protection field of the SLC 425I consists of the entire range located between the protection field markings of transmitter and receiver. Additional protective devices must ensure that the operator has to pass by the protection field to reach the hazardous machine parts.

The SLC 425I must be installed so that the personnel is always located within the detection zone of the safety device when operating the hazardous machine parts to be secured.

Correct installation

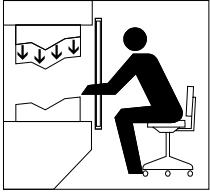

Hazardous machine parts can only be reached after passing through the protection field.

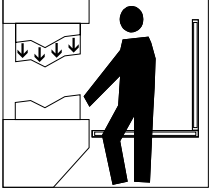

The presence of staff members between the protection field and hazardous machine parts must be prevented/avoided (protection against stepping over).

Unauthorised installation

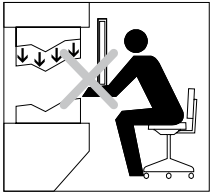

Hazardous machine parts can be reached without passing through the protection field.

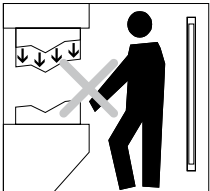

The presence of staff members between the protection field and hazardous machine parts is enabled.

3.3 Alignment

Procedure:

1. The transmitter and the receiver must be fitted parallel to each other and at the same height.
2. Turn the transmitter and monitor the diagnostic window of the receiver. Fix the light curtain, when the LED OSSD ON (green) is on and the LED signal reception (orange) is off.
3. Determine the max. rotating angle to the left and to the right, at which the LED OSSD ON (green) is on and tighten the mounting screws in central position. Make sure that the LED signal reception (orange) is not on or flashing.

3.4 Safety distance

The safety distance is the minimum distance between the protection field of the safety light curtain and the hazardous area. The safety distance must be observed to ensure that the hazardous area cannot be reached before the hazardous movement has come to standstill.

Calculation of the safety distance to EN ISO 13855 (successor of EN 999) and EN ISO 13857

The safety distance depends on the following elements:

Run-on time of the machine (calculation by run-on time measurement)

- Response time of the machine and the safety light curtain and the downstream relay (entire safety guard)
- Approach speed
- Resolution of the safety light curtain

Safety light curtain SLC 425I

The safety distance for resolutions 14 mm up to 40 mm is calculated by means of the following formula:

$$(1) S = 2000 \text{ mm/s} * T + 8 (d - 14) \text{ [mm]}$$

S = Safety distance [mm]

T = Total reaction time (machine run-on time, reaction time of the safety guard, relays, etc.)

d = Resolution of the safety light curtain

The approach speed is covered with a value of 2000 mm/s

If value $S \leq 500$ mm after the calculation of the safety distance, then use this value.

If value $S \geq 500$ mm, recalculate the distance:

$$(2) S = 1600 \text{ mm/s} * T + 8 (d - 14) \text{ [mm]}$$

If the new value $S > 500$ mm, use this value as safety distance.

If the new value $S < 500$ mm, use a minimum distance of 500 mm.

Example:

Reaction time of the safety light curtain = 10 ms

Resolution of the safety light curtain = 14 mm

Stopping time of the machine = 330 ms

$$S = 2000 \text{ mm/s} * (330 \text{ ms} + 10 \text{ ms}) + 8(14 \text{ mm} - 14 \text{ mm})$$

$$S = 680 \text{ mm}$$

$$S = > 500 \text{ mm, therefore new calculation with } V = 1600 \text{ mm/s}$$

$$S = 544 \text{ mm}$$

The safety distance for resolutions 41 mm up to 70 mm is calculated by means of the following formula:

$$(3) S = (1600 \text{ mm/s} * T) + 850 \text{ mm}$$

S = Safety distance [mm]

T = Stopping time of the machine + reaction time of the safety light curtain

K = Approach speed 1600 mm/s

C = Safety supplement 850 mm



If the effective resolution is more than 70 mm, the detection of bodily parts is no longer guaranteed; to that end, the risks such as reaching into, climbing through and reference heights above the ground must be observed (refer to DIN EN ISO 13855). The formula (3) is also applicable to the calculation of the safety distance for the effective resolution from 41 mm to 300 mm.



The safety distance between the safety light curtain and the hazardous point must always be respected and observed. If a person reaches the hazardous point before the hazardous movement has come to standstill, he/she is exposed to serious injuries.

Safety distance to the hazardous area

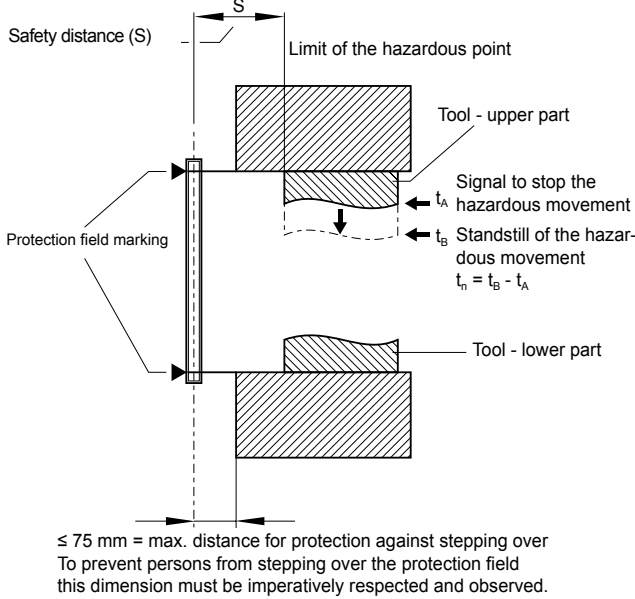

The formulae and calculation examples are related to the vertical set-up (refer to drawing) of the light curtain with regard to the hazardous point. Please observe the applicable harmonised EN standards and possible applicable national regulations.



The successor standards of the EN 999 for calculating the minimum distances of the safety guards with regard to the hazardous point are EN ISO 13855 and EN ISO 13857.

3.4.1 Minimum distance to reflecting surfaces

During the installation of the safety light curtain, the effects of reflecting surfaces must be taken into account. In case of an incorrect installation, interruptions of the protection field could possibly not be detected, which could lead to serious injuries. The hereafter-specified minimum distances with regard to reflecting surfaces (metal walls, floors, ceilings or parts) must be imperatively observed.

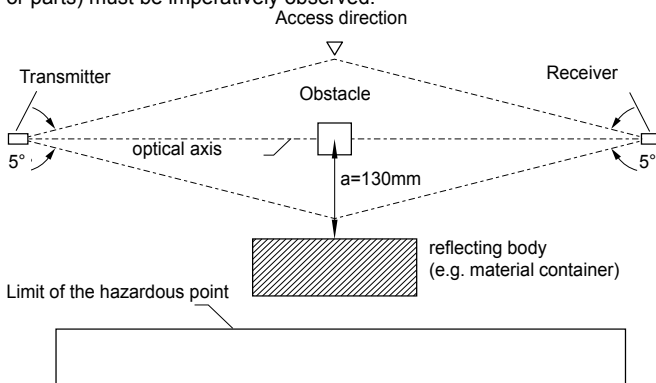
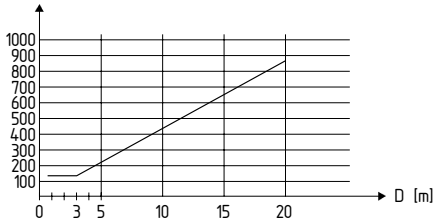

Table: Safety distance a
a [mm]



Calculate the minimum distance to reflecting surfaces as a function of the distance with an aperture angles of $\pm 2.5^\circ$ degrees or use the value from the table below:

| Distance between transmitter and receiver [m] | Minimum distance a [mm] |
|---|-------------------------|
| 0.2 ... 3.0 | 130 |
| 4 | 175 |
| 5 | 220 |
| 7 | 310 |
| 10 | 440 |
| 15 | 660 |

Formula: $a = \tan 2.5^\circ \times L$ [mm]

a = Minimum distance to reflecting surfaces
L = Distance between transmitter and receiver

3.5 Dimensions

All measurements in mm.

SLC 425I

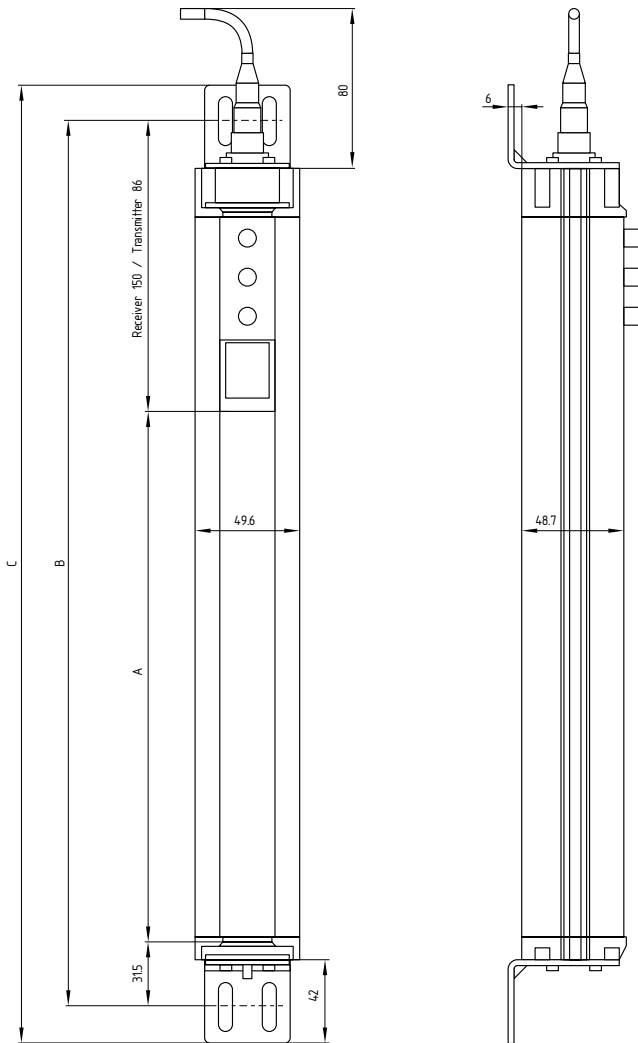

Legend

- A Protection field height
- B Mounting dimension
- C Total length

| Type | A | B | | C | |
|--------------------------|------|--------------|-----------|--------------|-----------|
| | | Trans-mitter | Recei-ver | Trans-mitter | Recei-ver |
| SLC 425I-E/R0170-XX-RFBC | 170 | 288 | 352 | 324 | 388 |
| SLC 425I-E/R0250-XX-RFBC | 250 | 368 | 432 | 404 | 468 |
| SLC 425I-E/R0330-XX-RFBC | 330 | 448 | 512 | 484 | 548 |
| SLC 425I-E/R0410-XX-RFBC | 410 | 528 | 592 | 564 | 628 |
| SLC 425I-E/R0490-XX-RFBC | 490 | 608 | 672 | 644 | 708 |
| SLC 425I-E/R0570-XX-RFBC | 570 | 688 | 752 | 724 | 788 |
| SLC 425I-E/R0650-XX-RFBC | 650 | 768 | 832 | 804 | 868 |
| SLC 425I-E/R0730-XX-RFBC | 730 | 848 | 912 | 884 | 948 |
| SLC 425I-E/R0810-XX-RFBC | 810 | 928 | 992 | 964 | 1028 |
| SLC 425I-E/R0890-XX-RFBC | 890 | 1008 | 1072 | 1044 | 1108 |
| SLC 425I-E/R0970-XX-RFBC | 970 | 1088 | 1152 | 1124 | 1188 |
| SLC 425I-E/R1050-XX-RFBC | 1050 | 1168 | 1232 | 1204 | 1268 |
| SLC 425I-E/R1130-XX-RFBC | 1130 | 1248 | 1312 | 1284 | 1348 |
| SLC 425I-E/R1210-XX-RFBC | 1210 | 1328 | 1392 | 1364 | 1428 |
| SLC 425I-E/R1290-XX-RFBC | 1290 | 1408 | 1472 | 1444 | 1508 |
| SLC 425I-E/R1370-XX-RFBC | 1370 | 1488 | 1552 | 1524 | 1588 |
| SLC 425I-E/R1450-XX-RFBC | 1450 | 1568 | 1632 | 1604 | 1668 |
| SLC 425I-E/R1530-XX-RFBC | 1530 | 1648 | 1712 | 1684 | 1748 |
| SLC 425I-E/R1610-XX-RFBC | 1610 | 1728 | 1792 | 1764 | 1828 |
| SLC 425I-E/R1690-XX-RFBC | 1690 | 1808 | 1872 | 1844 | 1908 |
| SLC 425I-E/R1770-XX-RFBC | 1770 | 1888 | 1952 | 1924 | 1988 |

Mounting kit MS-1030

The mounting kit consists of 4 steel angles and 16 fixing screws.

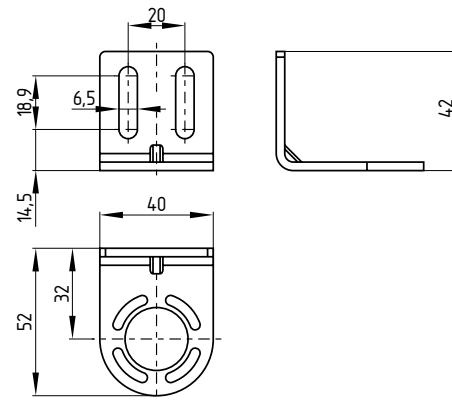

Centre fixing MS-1051 (optional accessory)

Mounting kit consists of 2 steel angles, 4 screws and 4 T-slot nuts for central fixing

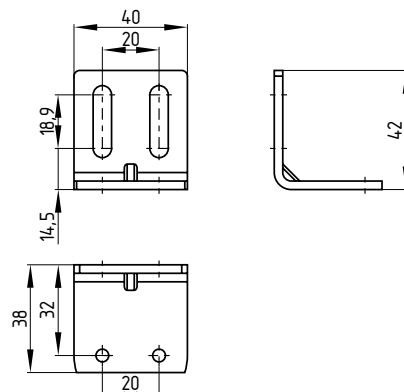

4. Electrical connection

4.1 Wiring example Muting

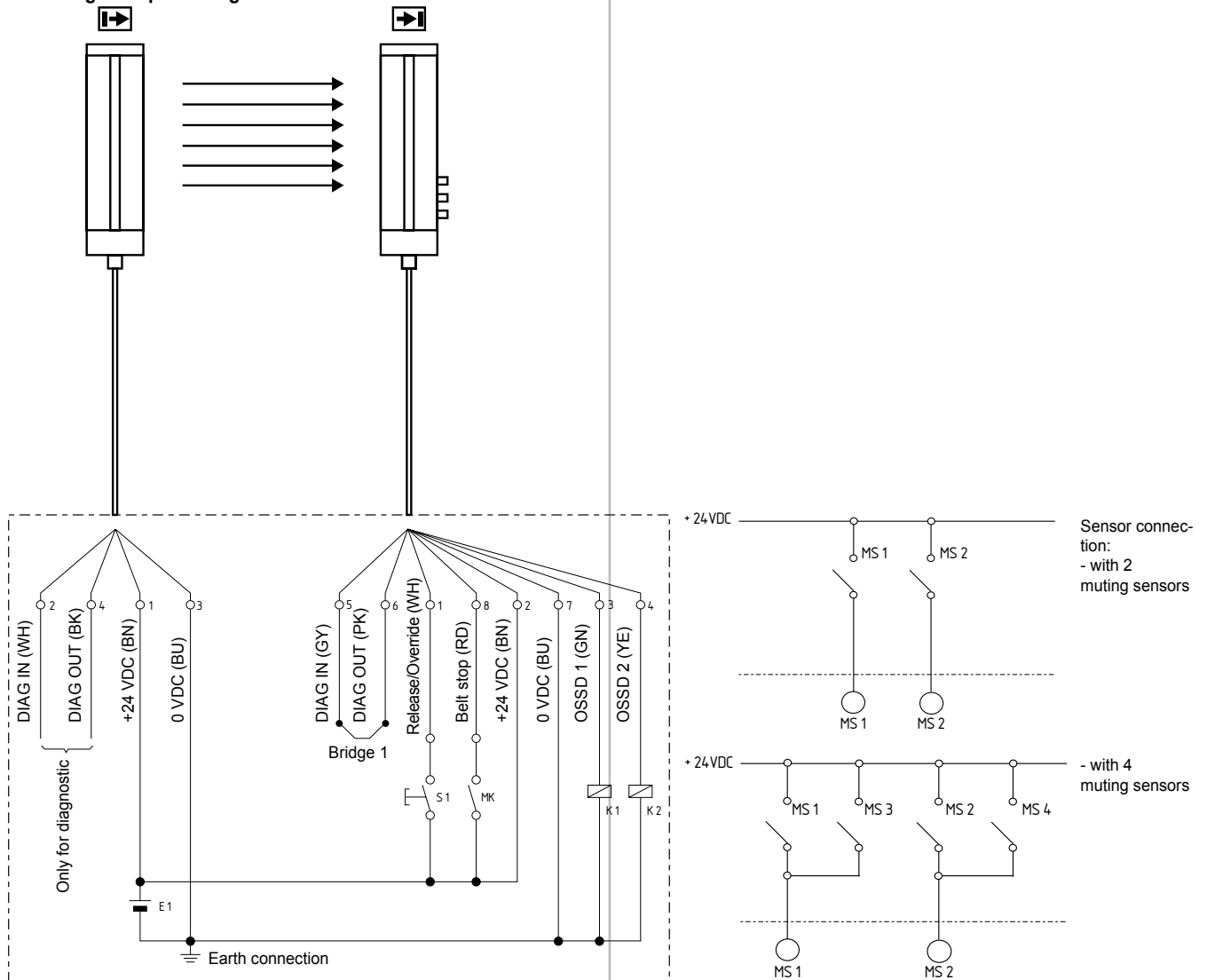

Legend

- Bridge 1: Restart interlock active (bridge between DIAG OUT and DIAG IN) The cable bridge between Pin 5 and 6 must always be wired
- K1, K2: Relay for processing the switching outputs OSSD 1, OSSD 2
- MK: Machine contact belt stop (optional)
- S1: Command device button for enabling restart/override
- E1: Power supply 24 VDC ± 10%

4.1.1 Connector configuration Receiver, Transmitter & Cable - Muting Mode

| RECEIVER SLC: connector male M12 / 8 pole | Signal Designation | Description |
|---|-----------------------|------------------------|
| 5 | WH Release/Override | Input |
| 2 | BN 24 VDC | Power supply |
| 3 | GN OSSD 1 | Safety output 1 |
| 4 | YE OSSD 2 | Safety output 2 |
| 5 | GY Diagnostic IN | Input diagnostic data |
| 6 | PK Diagnostic OUT | Output diagnostic data |
| 7 | BU 0 VDC | Power supply |
| 8 | RD Belt stop | Input |

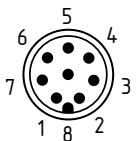

Cable: Connector
female M12 / 8 pole

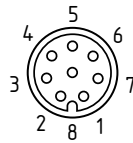

TRANSMITTER
SLC: connector
male M12 / 4 pole

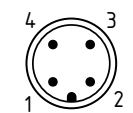

Cable: Connector
female M12 / 4 pole

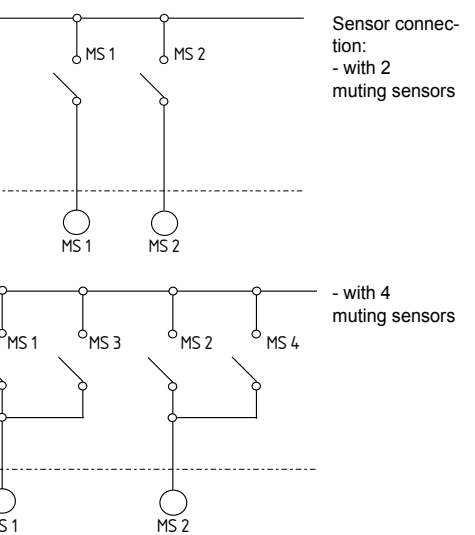
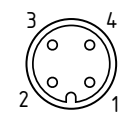

The colour codes are only valid for the cable types mentioned below "optional accessories".

4.2 Wiring example Cyclic operation

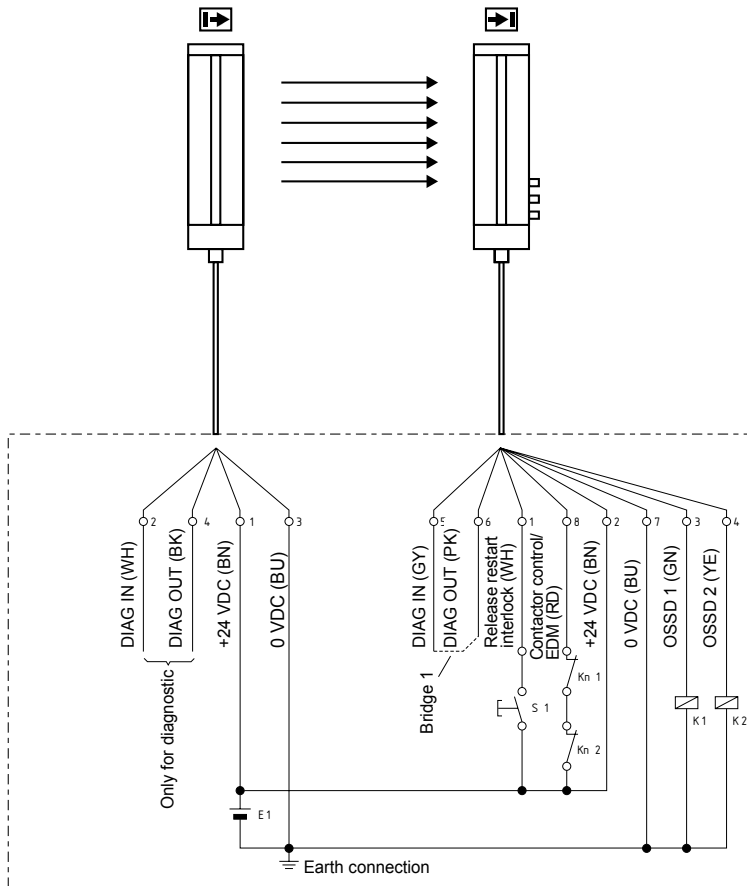

Legend

- Bridge 1: Restart interlock (manual reset) active
(The cable bridge between Pin 5 and 6 must always be wired)
- K1, K2: Relay for processing the switching outputs OSSD 1, OSSD 2
- Kn1, Kn2: Auxiliary contacts of the last switching relay (optional)
Signals at the EDM input (Pin 8) only to be disconnected when the function is activated
- S1: Command device for restart
- E1: Power supply 24 VDC ± 10%

i Upon delivery, the "contactor control" function is deactivated. The function is activated by means of the NSR0801 BUS converter and the PC software.

4.2.1 Connector configuration Receiver, Emitter & Cable - Cyclic operation

RECEIVER

SLC: Connector male M12 / 8 pol.

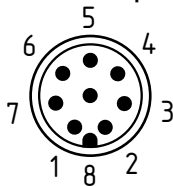

| Signal Designation | Description |
|--------------------|---------------------------------------|
| 1 WH | Start button Input |
| 2 BN | 24 VDC Power supply |
| 3 GN | OSSD 1 Safety output 1 |
| 4 YE | OSSD 2 Safety output 2 |
| 5 GY | Diagnostic IN Input diagnostic data |
| 6 PK | Diagnostic OUT Output diagnostic data |
| 7 BU | 0 VDC Power supply |
| 8 RD | Contactor control EDM Input |

Cable: Connector female M12 / 8 pole

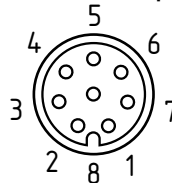

TRANSMITTER
SLC: Connector male M12 / 4 pol.

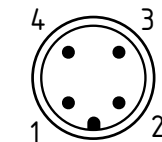

Cable: Connector female M12 / 4 pole

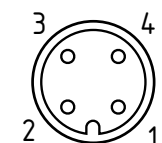

| Signal Designation | Description |
|--------------------|---------------------------------------|
| 1 BN | 24 VDC Power supply |
| 2 WH | Diagnostic IN Input diagnostic data |
| 3 BU | 0 VDC Power supply |
| 4 BK | Diagnostic OUT Output diagnostic data |



The colour codes are only valid for the cable types mentioned below "optional accessories".

4.3 Sensor connection field

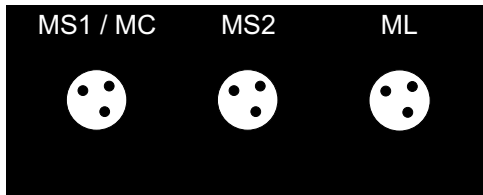

Muting sensor 1/machine contact MC, muting sensor 2, muting lamp

Muting sensors

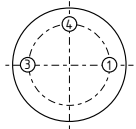

| PIN No. | Signal | Description |
|---------|----------|---|
| 1 | + 24 VDC | Power supply |
| 3 | 0 V | Power supply |
| 4 | + 24 VDC | Switching output Sensor / Machine contact |

Muting lamp

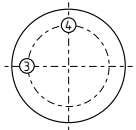

| PIN No. | Signal | Description |
|---------|----------|---------------------|
| 3 | 0 V | Power supply |
| 4 | + 24 VDC | Switching output ML |

5. Set-up and maintenance

5.1 Check before start-up

Prior to start-up the SLC 425, the following items must be checked by the responsible person.

Wiring check prior to start-up

1. The voltage supply is a 24V direct current power supply, which meets the CE Directives, Low Voltage Directives. A power downtime of 20 ms must be bridged.
2. Presence of a voltage supply with correct polarity at the SLC 425I.
3. The connecting cable of the transmitter is correctly connected to the transmitter and the connecting cable of the receiver correctly to the receiver.
4. The double insulation between the light curtain output and an external potential is guaranteed.
5. The outputs OSSD1 and OSSD2 are not connected to +24 VDC.
6. The connected switching elements (load) are not connected to 24 VDC.
7. If two or more SLC 425I are used within close range compared to each other, an alternating arrangement must be observed. Any mutual interference of the systems must be prevented (see chapter "Beam coding").

Switch the SLC 425I on and check the operation in the following way:

The component performs a system test during approx. 2 seconds after the operating voltage has been switched on. After that, the outputs are enabled (if the protection field is not interrupted). The LED "OSSD ON" of the receiver is on.



In case of incorrect functioning, please follow the instructions listed in the chapters Indication and Fault diagnostic.

5.2 Maintenance



Do not use the SLC 425I before the next inspection is terminated. An incorrect inspection can lead to serious and mortal injuries.

Conditions

For safety reasons, all inspection results must be archived. The operating principle of the SLC 425I and the machine must be known in order to be able conducting an inspection. If the fitter, the planning technician and the operator are different persons, please make sure that the user has the necessary information at his disposal to be able conduct the maintenance.

5.3 Regular check

A regular visual inspection and functional test, including the following steps, is recommended:

1. The safety light curtain does not have any visible damages.
2. The optics cover is not scratched or soiled.
3. Hazardous machinery parts can only be accessed by passing through the protection field of the SLC 425I.
4. The staff remains within the detection area, when works are conducted on hazardous machinery parts.
5. The safety distance of the application exceed the mathematically calculated one.

Operate the machine and check whether the hazardous movement stops under the hereafter-mentioned circumstances.

6. Hazardous machine parts do not move when the protection field is interrupted.
7. The hazardous machine movement is immediately stopped, when the protection field is interrupted with the test rod immediately before the transmitter, immediately before the receiver and in the middle between the transmitter and the receiver.
8. No hazardous machine movement when the test rod is within the protection field.
9. The hazardous machine movement comes to standstill, when the voltage supply of the SLC 425I is switched off.

5.4 Half-yearly inspection

The following items must be checked every six months or when a machine setting is changed.

1. Machine stops or does not inhibit any safety function.
2. No machine modification or connection change, which affects the safety system, has taken place.
3. The outputs of the SLC 425I are correctly connected to the machine.
4. The total response time of the machine does not exceed the response time calculated during the first putting into operation.
5. The cables, the connectors, the caps and the mounting angles of the SLC 425I are in perfect condition.

5.5 Cleaning

If the optics cover of the sensors is extremely soiled, the OSSD outputs of the SLC 425I can be disabled. Clean with a soft cloth without exercising pressure. The use of aggressive, abrasive or scratching cleaning agents, which could attack the surface, is prohibited.

6. Diagnostic

6.1 LED status information

Receiver

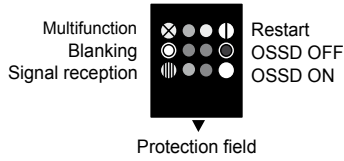

| Function | LED colour | Description |
|------------------|------------|--|
| Multifunction | green | Function display, beam coding |
| Blanking | blue | Protection field (e) inactive (blanking) |
| Signal reception | orange | Safety-monitoring module of signal reception |
| Restart | yellow | Input for command device |
| OSSD OFF | red | Safety outputs signal condition OFF |
| OSSD ON | green | Safety outputs signal condition ON |

Transmitter

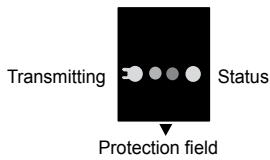

| Function | LED colour | Description |
|--------------|------------|-------------------------------|
| Transmitting | orange | Transmitter active |
| Status | green | Function display, beam coding |

| Receiver | Status LED | Description |
|-----------------------------------|------------------|---|
| LED | Status LED | Description |
| OSSD ON | ON | Protection field clear |
| | Flashing | Diagnostic mode active |
| OSSD OFF | ON | Protection field interrupted, system or configuration error |
| | Flashing | Diagnostic mode active, error output refer to Fault diagnostic table |
| Restart | ON | Start or restart interlock active, waiting for signal at output WA |
| Restart only for cyclic operation | ON | Request actuation of the start button |
| | Flashing 2 Hz | Request refer to start condition |
| Signal reception | Flashing 0.25 Hz | Request for operator intervention |
| | ON/flashing | Signal reception too low, check alignment and installation height between transmitter and receiver cleaning the black profile cover |
| Blanking | OFF | Alignment between transmitter and receiver OK |
| | 1 flashes | Fixed blanking of the protection field(s) |
| Variable blanking * | 2 flashes | Floating blanking, max. 1 beam |
| | 3 flashes | Variable blanking, multiple beams |
| | 4 flashes | Floating (max. 1 beam) and fixed blanking of protection field(s) |
| Multi-function display | 5 flashes | Mobile (multiple beams) and fixed blanking of protection field(s) |
| | 1 flashes | Muting (complete protection field) |
| | 2 flashes | Muting (only teached protection field) |
| | 3 flashes | Muting through BUS control |
| | 4 flashes | Cyclic operation |
| | 5 flashes | Beam coding A is active |

* This function is not available for the operating modes "muting" and "cyclic operation"

| Transmitter | Status LED | Description |
|--------------|------------|--|
| LED | Status LED | Description |
| Transmitting | ON | Standard operation, transmitter active |
| | flashing | Configuration error |
| Status | flashing | Beam coding A is active |

6.2 Fault diagnostic

The light curtain performs an internal self-test after the operating voltage is switched on and the protection field is enabled. When a fault is detected, a corresponding flashing pattern is emitted at the receiver through the LED OSSD OFF (red). Every fault emission is followed by a one-second pause.

| LED OSSD OFF | Fault feature | Action |
|---|---|--|
| OSSD OFF and LED re-start continuous flashing | Wiring error for function selection (restart interlock, automatic mode) | Check connection at the receiver, bridge 1 or bridge 2 must be wired (refer to Wiring) |
| 1 flashes | Error at sensor receiver | Replace receiver |
| 2 flashes | Error contactor control OFF | Check connections at contactor control input, refer to Wiring Check wiring of the auxiliary contacts |
| 3 flashes | Error contactor control ON | Check connections at contactor control input Check short-circuit at +UB and mass Power reset after fault rectification. |
| 4 flashes | Errors at the OSSD outputs | Check the wiring of the outputs, OSSD for short-circuit at +UB and mass |
| 5 flashes | Error configuration data | Check the configuration settings by means of the NSR-0801 BUS converter |
| 6 flashes | Error blanking | The receiver has detected blanked beams as beams without interruption, i.e. locking. Check the configuration settings by means of the NSR-0801 BUS converter, repeat the teach process with blanking. |

6.3 Extended diagnostic

By means of the optional configuration software and the NSR-0801 BUS converter, an extended diagnostic can be executed. The software provides the status information of the component and can represent the individual light lines. This feature enables an optimal adjustment of the light curtain. The diagnostic mode is signalled by the OSSD ON and OSSD OFF LED's at the receiver. In diagnostic mode, protective mode is disabled, the ODDS outputs being locked. The change from diagnostic mode to protective mode is automatically realised after Power Reset, when the BUS converter is no longer integrated and the connecting cable of the sensor is reconnected.

7. Disassembly and disposal

7.1 Disassembly

The safety switchgear must be disassembled in a de-energised condition only.

7.2 Disposal

The safety switchgear must be disposed of in an appropriate manner in accordance with the national prescriptions and legislations.

8. Appendix

8.1 Contact

Consultancy / Sales:



K.A. Schmersal GmbH
 Industrielle Sicherheitssysteme
 Möddinghofe 30
 D-42279 Wuppertal
 Tel:+49 (0) 202 64 74 -0
 Fax:+49 (0) 202 64 74- 100

You will also find detailed information regarding our product variety on our website: www.schmersal.com

Repair handling / shipping:

Safety Control GmbH
 Am Industriepark 11
 D-84453 Mühldorf / Inn
 Tel.: +49 (0) 8631-18796-0
 Fax: +49 (0) 8631-18796-1

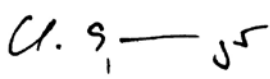
8.2 EC Declaration of conformity

| | | |
|--|--|---|
|  | | |
| EC Declaration of conformity | | |
| Translation of the original declaration of conformity Safety Control GmbH Am Industriepark 33 84453 Mühldorf / Inn Germany Internet: www.schmersal.com | | |
| We hereby certify that the hereafter described safety components both in its basic design and construction conform to the applicable European Directives. | | |
| Name of the safety component / type: | SLC 425I | |
| Description of the safety component: | Safety light curtain | |
| Harmonised EC-Directives: | 2006/42/EC EC-Machinery Directive 2004/108/EC EMC-Directive | |
| Applied standards: | EN 61496-1:2004 + A1 2008 CLC/TS 61496-2:2006 EN ISO 13849-1:2008; PL e EN 62061:2005; SIL 3 | |
| Person authorized for the compilation of the technical documentation: | Ulrich Loss Möddinghofe 30 42279 Wuppertal | |
| Notified body for the prototype test: | TÜV Nord Cert GmbH Langemarckstr.20 45141 Essen ID n°: 0044 | |
| EC-prototype test certificate: | n° 44 205 10 555867 005 | |
| Place and date of issue: | Wuppertal, February 1, 2010 | |
| SLC 425I-B-EN |  Authorized signature Christian Spranger Managing Director |  Authorized signature Klaus Schuster Managing Director |



The currently valid declaration of conformity can be downloaded from the internet at www.schmersal.net.



Safety Control GmbH
Am Industriepark 33
D-84453 Mühldorf / Inn

Telefon +49 - (0)86 31 - 187 - 9 60
Telefax +49 - (0)86 31 - 187 - 9 61
E-Mail: info@safetycontrol.com