

TECHNICAL DATA & SERVICE MANUAL



**INDOOR UNIT: KPAF124R5
KPAF185R5
KPAF225R5**

SPLIT SYSTEM AIR CONDITIONER

Model No.	Product Code No.
KPAF124R5	387105949
KPAF185R5	387005960
KPAF225R5	387005961

Floor Mounted

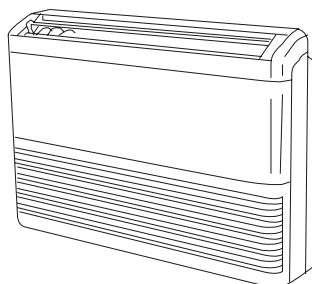

Ceiling Mounted

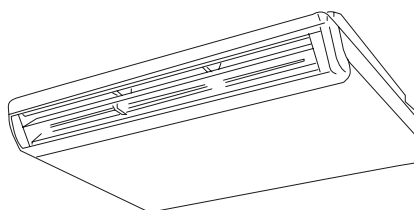

IMPORTANT! **Please read before installation**

This air conditioning system meets strict safety and operating standards.

For the installer or service person, it is important to install or service the system so that it operates safely and efficiently.

For safe installation and trouble-free operation, you must:

- Carefully read this instruction booklet before beginning.
- Follow each installation or repair step exactly as shown.
- Observe all local, state and national electrical codes.
- Pay close attention to all warning and caution notices given in this manual.
- The unit must be supplied with a dedicated electrical line.



WARNING

This symbol refers to a hazard or unsafe practice which can result in severe personal injury or death.



CAUTION

This symbol refers to a hazard or unsafe practice which can result in personal injury or product or property damage.

If necessary, get help

These instructions are all you need for most installation sites and maintenance conditions.

If you require help for a special problem, contact our sale/service outlet or your certified dealer for additional instructions.

In case of improper installation

The manufacturer shall in no way be responsible for improper installation or maintenance service, including failure to follow the instructions in this document.

SPECIAL PRECAUTIONS

- During installation, connect before the refrigerant system and then the wiring one; proceed in the reverse order when removing the units.

WARNING

When wiring



ELECTRICAL SHOCK CAN CAUSE SEVERE PERSONAL INJURY OR DEATH. ONLY A QUALIFIED, EXPERIENCED ELECTRICIANS SHOULD ATTEMPT TO WIRE THIS SYSTEM.

- Do not supply power to the unit until all wiring and tubing are completed or reconnected and checked, to ensure the grounding.
- Highly dangerous electrical voltages are used in this system. Carefully refer to the wiring diagram and these instructions when wiring. Improper connections and inadequate grounding can cause **accidental injury and death.**

- **Ground the unit** following local electrical codes.
- The Yellow/Green wire cannot be used for any connection different from the ground connection.
- Connect all wiring tightly. Loose wiring may cause overheating at connection points and a possible fire hazard.
- Do not allow wiring to touch the refrigerant tubing, compressor, or any moving parts of the fan.
- Do not use multi-core cable when wiring the power supply and control lines. Use separate cables for each type of line.

When transporting

Be careful when picking up and moving the indoor and outdoor units. Get a partner to help, and bend your knees when lifting to reduce strain on your back. Sharp edges or thin aluminium fins on the air conditioner can cut your fingers.

When installing...

... In a ceiling or wall

Make sure the ceiling/wall is strong enough to hold the unit-weight. It may be necessary to build a strong wooden or metal frame to provide added support.

... In a room

Properly insulate any tubing run inside a room to prevent "sweating", which can cause dripping and water damage to walls and floors.

... In moist or uneven locations

Use a raised concrete base to provide a solid level foundation for the outdoor unit.

This prevents damage and abnormal vibrations.

... In area with strong winds

Securely anchor the outdoor unit down with bolts and a metal frame. Provide a suitable air baffle.

... In a snowy area (for heat pump-type systems)

Install the outdoor unit on a raised platform that is higher than drifting snow. Provide snow vents.

When connecting refrigerant tubing

- Keep all tubing runs as short as possible.
- Use the flare method for connecting tubing.
- Apply refrigerant lubricant to the matching surfaces of the flare and union tubes before connecting them; screw by hand and then tighten the nut with a torque wrench for a leak-free connection.
- Check carefully for leaks before starting the test run.

NOTE:

Depending on the system type, liquid and gas lines may be either narrow or wide. Therefore, to avoid confusion, the refrigerant tubing for your particular model is specified as narrow tube for liquid, wide tube for gas.

When servicing

- Turn the power OFF at the main power board before opening the unit to check or repair electrical parts and wiring.
- Keep your fingers and clothing away from any moving parts.
- Clean up the site after the work, remembering to check that no metal scraps or bits of wiring have been left inside the unit being serviced.
- Ventilate the room during the installation or testing the refrigeration system; make sure that, after the installation, no gas leaks are present, because this could produce toxic gas and dangerous if in contact with flames or heat-sources.

Table of Contents

	Page
1. SPECIFICATIONS	4
1-1 Unit specifications	4
1-2 Major Component specifications	7
1-3 Other Component specifications	10
2. DIMENSIONAL DATA	11
3. ELECTRICAL DATA	12
3-1 Electric Wiring Diagrams	12
4. FUNCTION	13
4-1 Cool Mode Operation	13
4-2 Heat Mode Operation	14
4-3 Auto Mode Operation	15
4-4 Dry Mode Operation	16
4-5 Fan Mode Operation	17
4-6 Protections in Cool/Dry Mode	17
4-7 Protections in Heat Mode	19
4-8 Sleep Function	22
4-9 Daily Timer	22
4-10 I FEEL Function	22
5. TROUBLESHOOTING	23
5-1 Check before and after troubleshooting	23
5-2 Air conditioner does not operate	23
5-3 Some part of air conditioner does not operate	27
5-4 Air conditioner operates, but abnormalities are observed	29
5-5 If a sensor is defective	31
6. CHECKING ELECTRICAL COMPONENTS	32
6-1 Measurement of Insulation Resistance	32
6-2 Checking Continuity of Fuse on PCB Ass'y	33
6-3 Checking Motor Capacitor	33

1. SPECIFICATIONS

1-1 Unit Specifications

KPAF124R5

Power source	220 - 240 V ~ 50 Hz
---------------------	---------------------

Voltage rating	230 V
-----------------------	-------

Performance	Cooling	Heating
Capacity	See catalogue with the requested matching	
Air circulation	High	m ³ /h
		700

Features			
Controls/Temperature controls	Microprocessor/ I.C. thermostat		
Control unit	Wireless remote control unit		
Timer	ON/OFF 24 hours		
Fan speed	3 and Auto		
Airflow direction	Horizontal	Manual	
	Vertical	Auto	
Air Filter	Washable, Anti-Mold		
Power noise level	High	dB(A)	55
Refrigerant tubing connections	Flare type		
Refrigerant tube diameter	Narrow tube	mm(in.)	6.35 (1/4)
	Wide tube	mm(in.)	9.52 (3/8)
Refrigerant	R410A		
Refrigerant tube kit / Air clean filter	Optional / Optional		

Dimensions & Weight			
Unit dimensions	Height	mm	680
	Width	mm	900
	Depth	mm	190
Package dimensions	Height	mm	770
	Width	mm	995
	Depth	mm	280
Weight	Net	kg	23,5
	Shipping	kg	31,5
Shipping volume		m ³	0,21

DATA SUBJECT TO CHANGE WITHOUT NOTICE

KPAF185R5

Power source	220 - 240 V ~ 50 Hz
---------------------	---------------------

Voltage rating	230 V
-----------------------	-------

Performance	Cooling	Heating
Capacity	See catalogue with the requested matching	
Air circulation	High	m ³ /h 800

Features			
Controls/Temperature controls		Microprocessor/ I.C. thermostat	
Control unit		Wireless remote control unit	
Timer		ON/OFF 24 hours	
Fan speed		3 and Auto	
Airflow direction		Horizontal	Manual
		Vertical	Auto
Air Filter		Washable, Anti-Mold	
Power noise level		High	dB(A) 59
Refrigerant tubing connections		Flare type	
Refrigerant tube diameter		Narrow tube	mm(in.) 6.35 (1/4)
		Wide tube	mm(in.) 12.7 (1/2)
Refrigerant		R410A	
Refrigerant tube kit / Air clean filter		Optional / Optional	

Dimensions & Weight			
Unit dimensions	Height	mm	680
	Width	mm	900
	Depth	mm	190
Package dimensions	Height	mm	770
	Width	mm	995
	Depth	mm	280
Weight	Net	kg	23,5
	Shipping	kg	31,5
Shipping volume		m ³	0,21

DATA SUBJECT TO CHANGE WITHOUT NOTICE

KPAF225R5

Power source	220 - 240 V ~ 50 Hz
---------------------	---------------------

Voltage rating	230 V
-----------------------	-------

Performance		Cooling	Heating
Capacity		See catalogue with the requested matching	
Air circulation	High	m ³ /h	800

Features			
Controls/Temperature controls		Microprocessor/ I.C. thermostat	
Control unit		Wireless remote control unit	
Timer		ON/OFF 24 hours	
Fan speed		3 and Auto	
Airflow direction		Horizontal	Manual
		Vertical	Auto
Air Filter		Washable, Anti-Mold	
Power noise level	High	dB(A)	60
Refrigerant tubing connections		Flare type	
Refrigerant tube diameter	Narrow tube	mm(in.)	9.52 (3/8)
	Wide tube	mm(in.)	15.88 (5/8)
Refrigerant		R410A	
Refrigerant tube kit / Air clean filter		Optional / Optional	

Dimensions & Weight			
Unit dimensions	Height	mm	680
	Width	mm	900
	Depth	mm	190
Package dimensions	Height	mm	770
	Width	mm	995
	Depth	mm	280
Weight	Net	kg	23,5
	Shipping	kg	31,5
Shipping volume		m ³	0,21

DATA SUBJECT TO CHANGE WITHOUT NOTICE

1-2 Major Component Specifications

KPAF124R5

Controller PCB	
Part No.	KSA
Controls	Microprocessor
Control circuit fuse	250 V - 5 A

Remote Control Unit	RC-2 (RC) - RC-7 (RC)
---------------------	-----------------------

Fan & Fan Motor	
Type	Cross - flow
Q'ty Dia. and length	mm 2... Ø 130 / L 180
Fan motor model...Q'ty	K48407-M01596...1
No. of poles...rpm (230 V, High)	4...1160
Nominal output	W 21
Running Amps	A 0,29
Power input	W 65
Coil resistance (Ambient temp. 25 °C)	Ω GRY-WHT: 298÷343 WHT-PNK: 421÷485 WHT-VLT: 93,5÷108 VLT-ORG: 93,5÷108 ORG-YEL: 211÷243
Safety devices	Type Thermal protection
	Operating temp. Open °C 145 ± 5
	Close Automatic
Run capacitor	μF 1.5
	VAC 440

Flap Motor	
Type	Synchro motor
Model	M2LJ24ZE31
Rating	AC 208/230 V ; 50-60 Hz
No. of poles...rpm	8...2,5÷3
Nominal output	W 2,5÷3
Coil resistance (Ambient temp. 25 °C)	κΩ 16,45±15%

Heat Exch. Coil	
Coil	Aluminium plate fin / Copper tube
Rows	2
Fin pitch	mm 1,8
Face area	0,192

DATA SUBJECT TO CHANGE WITHOUT NOTICE

KPAF185R5

Controller PCB	
Part No.	KSA
Controls	Microprocessor
Control circuit fuse	250 V - 5 A

Remote Control Unit	RC-7 (RC)
---------------------	-----------

Fan & Fan Motor	
Type	Cross - flow
Q'ty Dia. and length	mm 2.... Ø 130 / L 180
Fan motor model...Q'ty	K48407-M01597...1
No. of poles...rpm (230 V, High)	4...1140
Nominal output	W 27
Running Amps	A 0,33
Power input	W 75
Coil resistance (Ambient temp. 25 °C)	Ω GRY-WHT: 194÷223 WHT-VLT: 80,1÷92,2 VLT-ORG: 80,1÷92,2 ORG-YEL: 200÷230 WHT-PNK: 238÷274
Safety devices	Type Thermal protection
	Operating temp. Open °C 145 ± 5
	Close Automatic
Run capacitor	μF 2
	VAC 440

Flap Motor	
Type	Synchro motor
Model	M2LJ24ZE31
Rating	AC 208/230 V ; 50-60 Hz
No. of poles...rpm	8...2,5÷3
Nominal output	W 2,5÷3
Coil resistance (Ambient temp. 25 °C)	κΩ 16,45±15%

Heat Exch. Coil	
Coil	Aluminium plate fin / Copper tube
Rows	2
Fin pitch	mm 1,8
Face area	0,192

DATA SUBJECT TO CHANGE WITHOUT NOTICE

KPAF225R5

Controller PCB	
Part No.	KSA
Controls	Microprocessor
Control circuit fuse	250 V - 5 A

Remote Control Unit	RC-7 (RC)
---------------------	-----------

Fan & Fan Motor	
Type	Cross - flow
Q'ty Dia. and length mm	2.... Ø 130 / L 180
Fan motor model...Q'ty	K48407-M01598...1
No. of poles...rpm (230 V, High)	4...1280
Nominal output W	41
Running Amps A	0,41
Power input W	88
Coil resistance (Ambient temp. 25 °C) Ω	GRY-WHT: 124÷144 WHT-VLT: 69,3÷79,8 VLT-ORG: 69,3÷79,8 ORG-YEL: 200÷233 WHT-PNK: 255÷294
Safety devices	Type Thermal protection
	Operating temp. Open °C 145 ± 5
	Close Automatic
Run capacitor μF	1.5
	VAC 440

Flap Motor	
Type	Synchro motor
Model	M2LJ24ZE31
Rating	AC 208/230 V ; 50-60 Hz
No. of poles...rpm	8...2,5÷3
Nominal output W	2,5÷3
Coil resistance (Ambient temp. 25 °C) κΩ	16,45±15%

Heat Exch. Coil	
Coil	Aluminium plate fin / Copper tube
Rows	2
Fin pitch mm	1,8
Face area	0,192

DATA SUBJECT TO CHANGE WITHOUT NOTICE

1-3 Other Component Specifications

Thermistor (Coil sensor TH1)		
Resistance	K Ω	10 \pm 3%

Thermistor (Room sensor TH2)		
Resistance	K Ω	10 \pm 5%

2. DIMENSIONAL DATA

Unit: mm

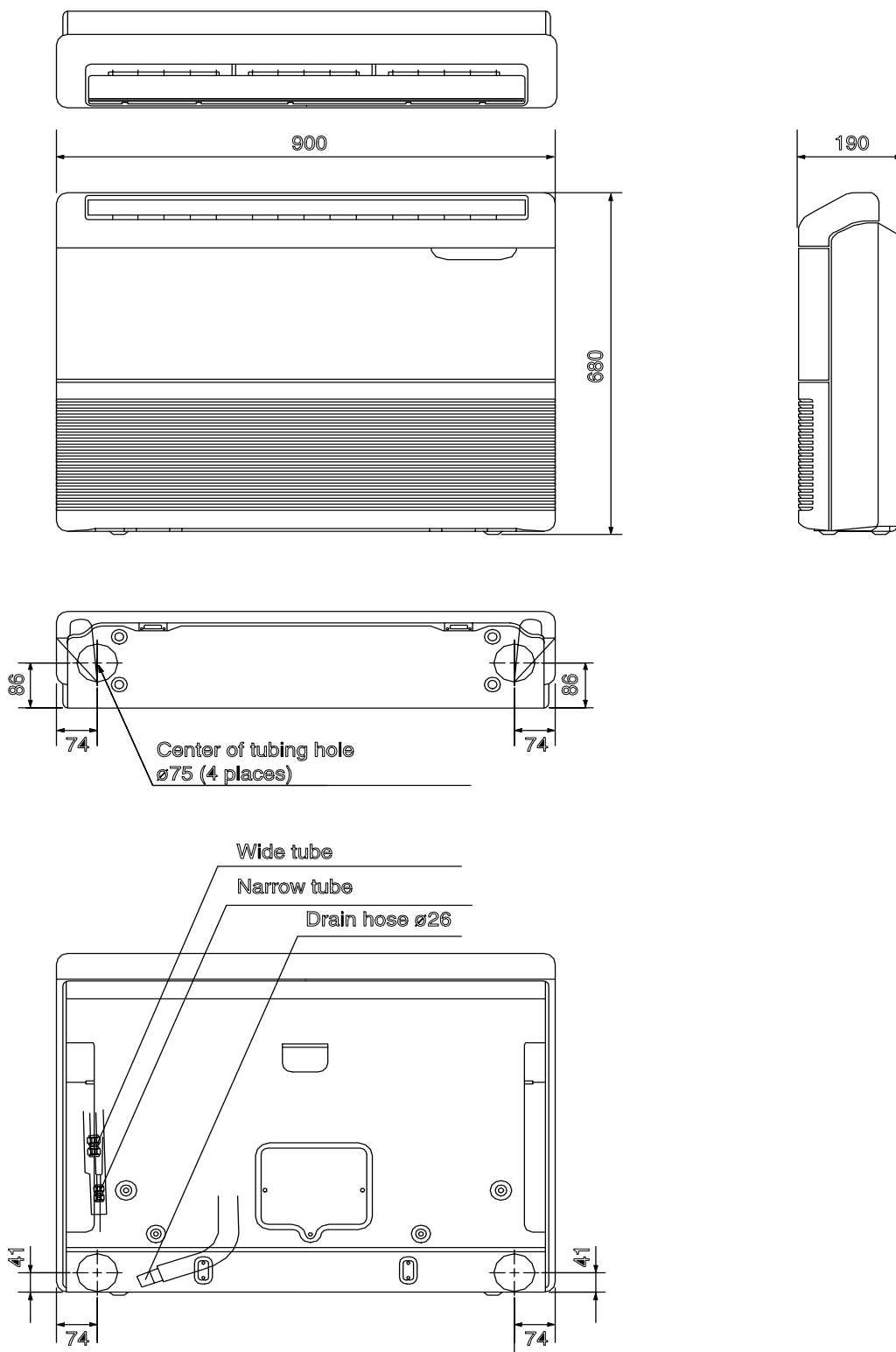

3. ELECTRICAL DATA

3-1 Electric Wiring Diagrams

KPAF124R5

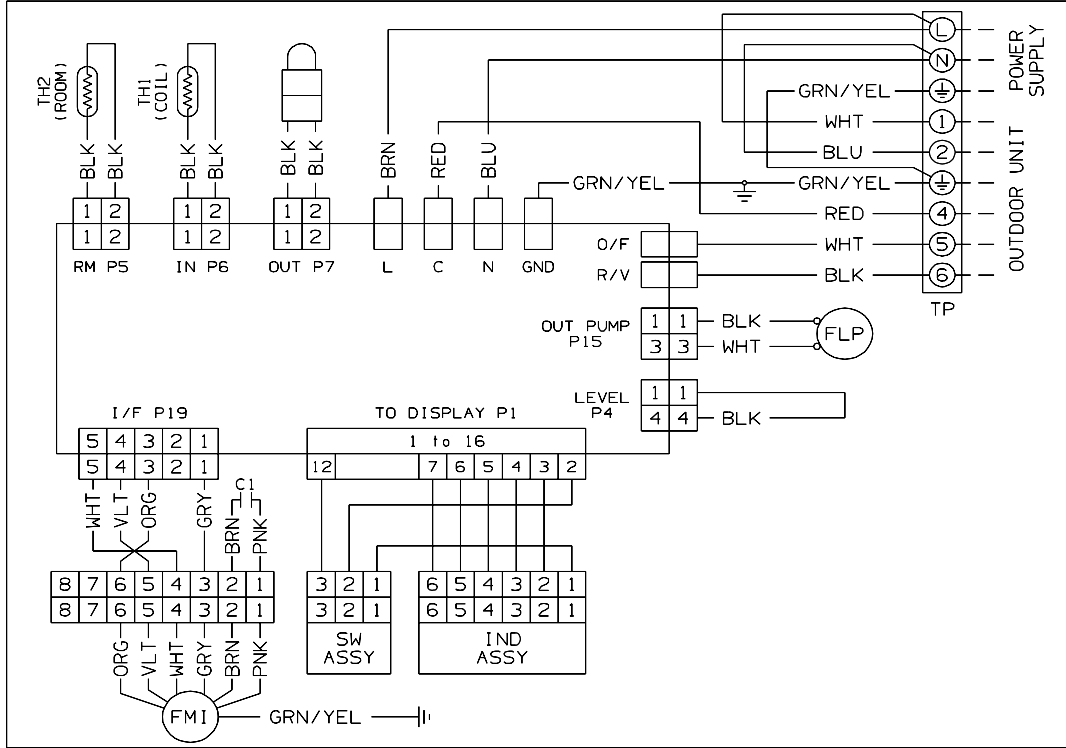

KPAF185R5

KPAF225R5

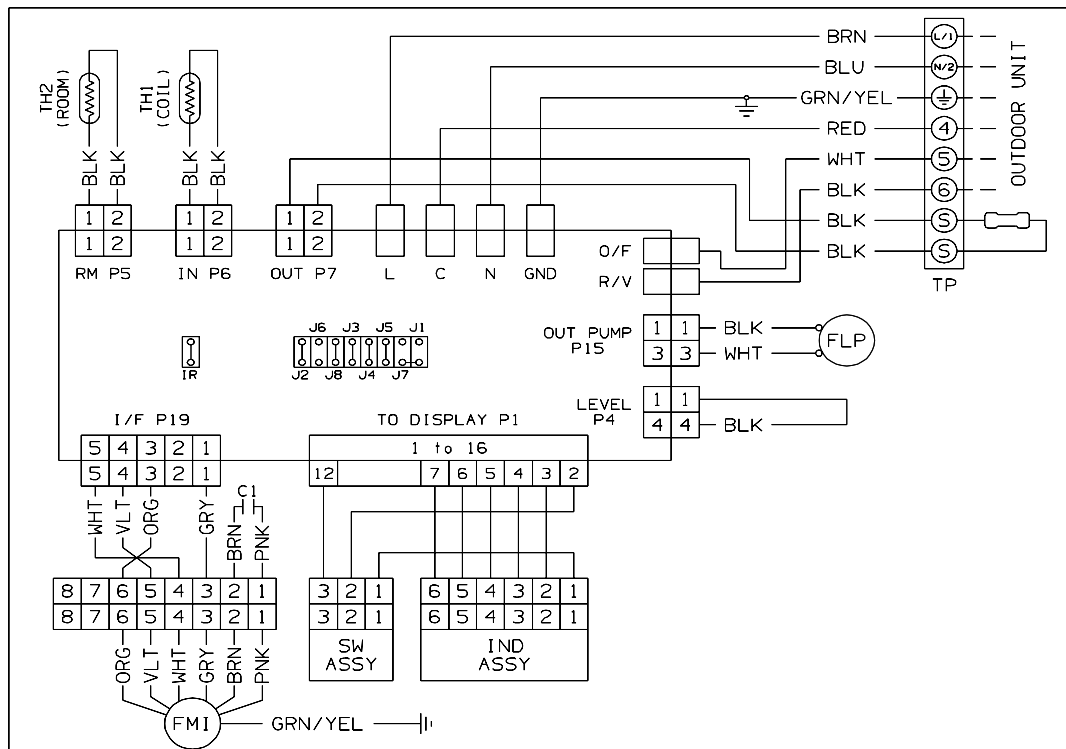

4. FUNCTION

4-1 Cool Mode Operation

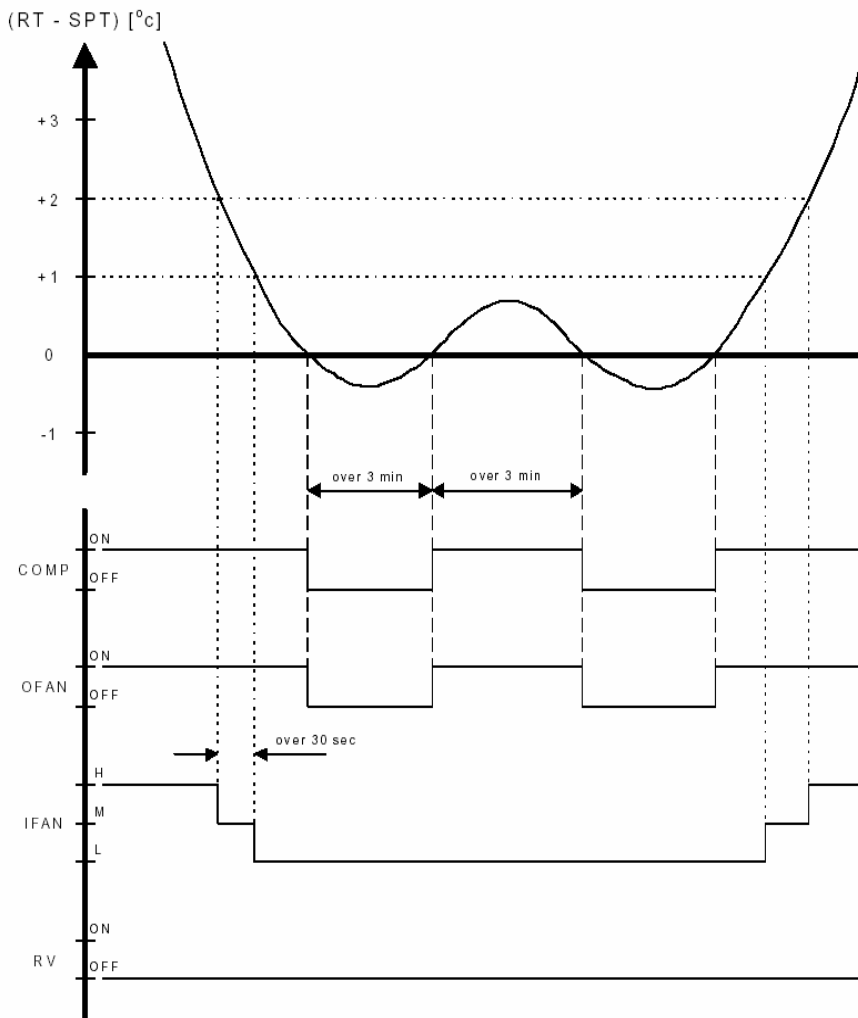

In Cool Mode, the operation of the Compressor (COMP), Outdoor Fan (OFAN) and Indoor Fan (IFAN) are determined by the difference between the Room Temperature (RT) and the Set Point Temperature (SPT) as in the graph above.

Notes:

- In this graph, the IFAN is operating in the "Auto Fan Speed" setting. If the user has selected the low, medium or high fan speed, the IFAN will run constantly at that speed only.
- In addition to the value of $(RT-SPT)$, the operations of the relays are also controlled by protection delays. For example, (a) the minimum On/Off time of the COMP is 3 min and 3 min respectively, and (b) the IFAN can change speed only after it has operated at the same speed for 30 sec in autofan setting and 1 sec for H/M/L setting.

4-2 Heat Mode Operation

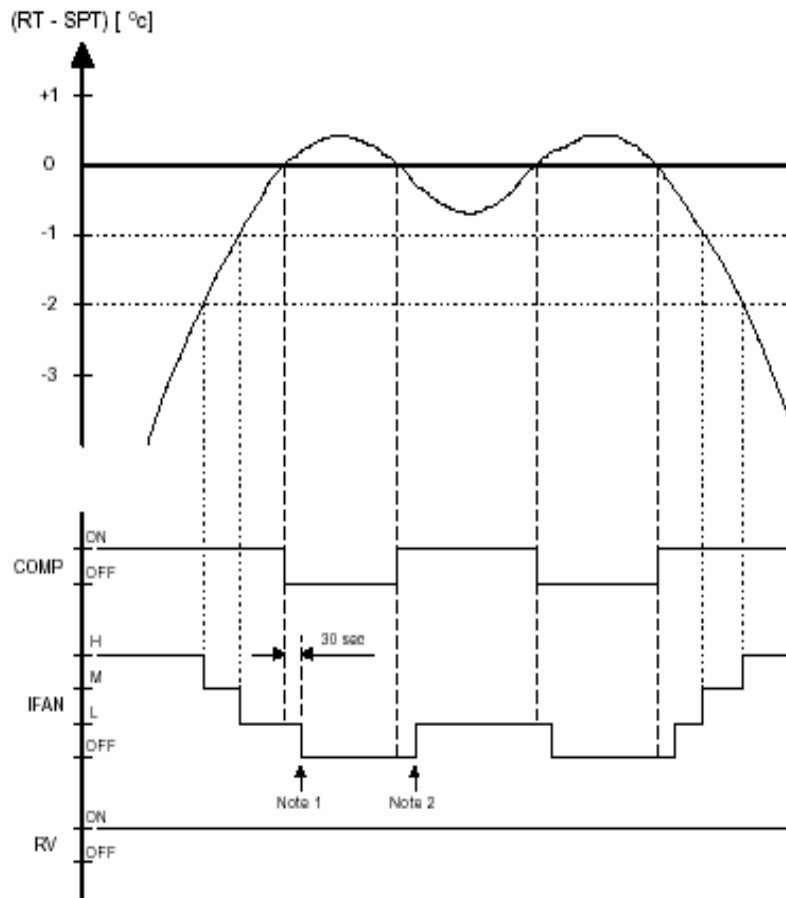

The Heat Mode operation is similar to the Cool Mode operation. The COMP, OFAN and IFAN are mainly controlled by the value of $(RT - SPT)$. In the graph above, the IFAN is operating in Auto Fan speed mode. Therefore, the IFAN speed changes automatically according to the $(RT - SPT)$.

Note 1: The 30s IFAN operation is for purging the heat from the in-coil after COMP has stopped.

Note 2: The IFAN will not be turned on until the in-coil temperature is high enough (as shown in the graph below) to prevent the unit from supplying cool air.

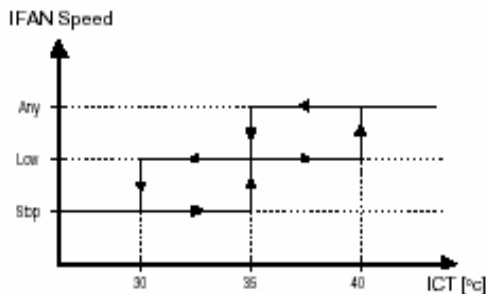

ICT = In-coil Temperature

Any = Hi, Med or Low fan speed which is selected by the user. In Auto Fan Speed Mode, the fan speed is selected by the unit automatically instead.

Low = The indoor fan is forced to operate at low speed

4-3 Auto (Cool/Heat) Mode Operation

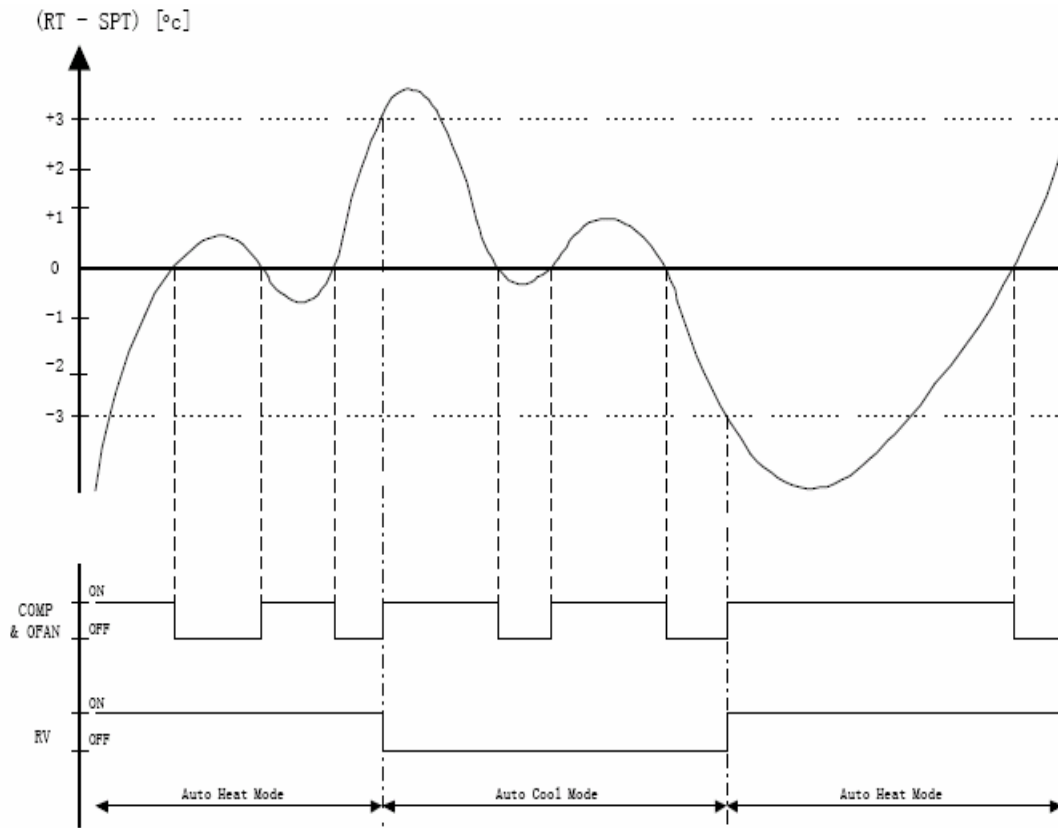

In Auto Mode, the unit switches between the Auto Cooling Mode and Auto Heating Mode automatically to maintain the room temperature (RT) at the set point temperature (SPT).

4-4 Dry Mode Operation

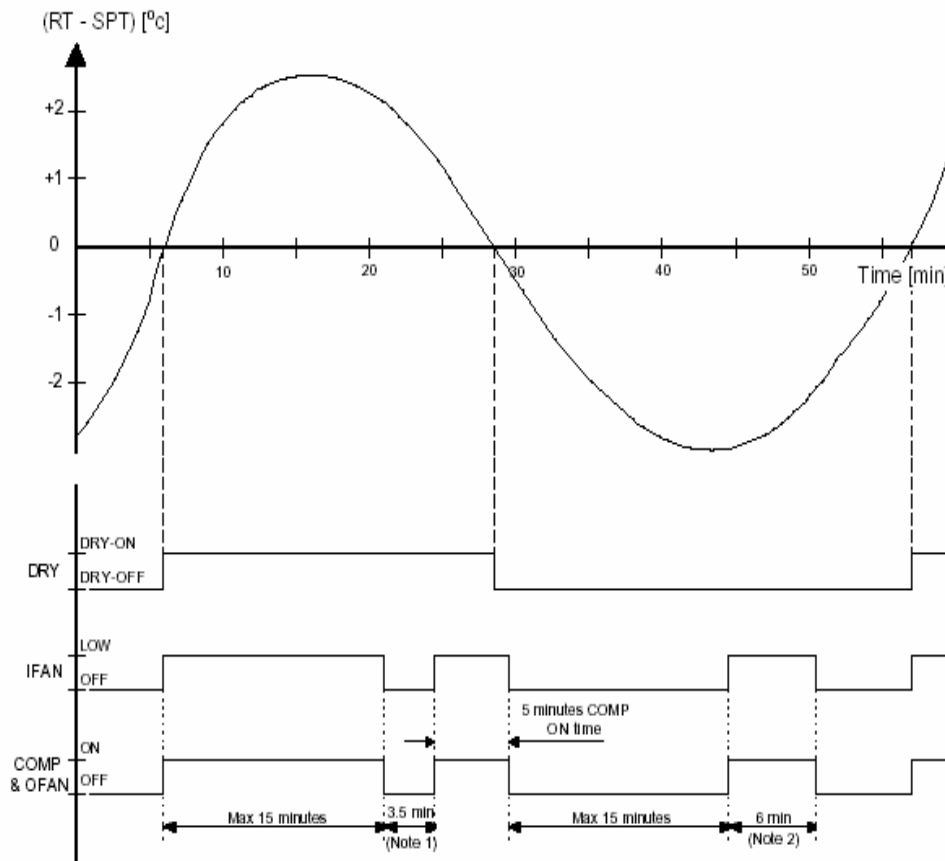

In Dry Mode, the unit operates in a mild cool mode to lower the humidity of the room. In order to maintain a high efficiency in the drying operation without over lowering the room temperature excessively, the Dry Mode is different from the Cool Mode in two ways.

- The IFAN is forced to operate at low speed only. And, the IFAN is turned off with the COMP.
- The unit operates in either the "Dry-on" state or the "Dry-off" state. If $RT < SPT$, the unit will operate in "Dry-off" state. After the COMP has stopped working for 15 min, it is forced to operate for 6 min. If $RT > SPT$, the unit will operate in "Dry-on" state. After the COMP has been working for 15 min, it is forced off for 3.5 min.

Note 1: COMP is forced off in Dry-on state.

Note 2: COMP is forced to operate in Dry-off state.

4-5 Fan Mode Operation

In Fan Mode, the indoor fan is turned on to improve the air circulation in the room. COMP and OFAN remain OFF all the time.

Note: If the user has selected the Auto Fan Speed setting, the IFAN speed would be selected by the unit automatically according to the difference between RT and SPT, as in Cool Mode.

4-6 Protection operations in Cool and Dry Mode

1. Indoor Coil Defrost Protection

The in-coil defrost protection can prevent the ice formation at the in-coil when the ambient temperature is low.

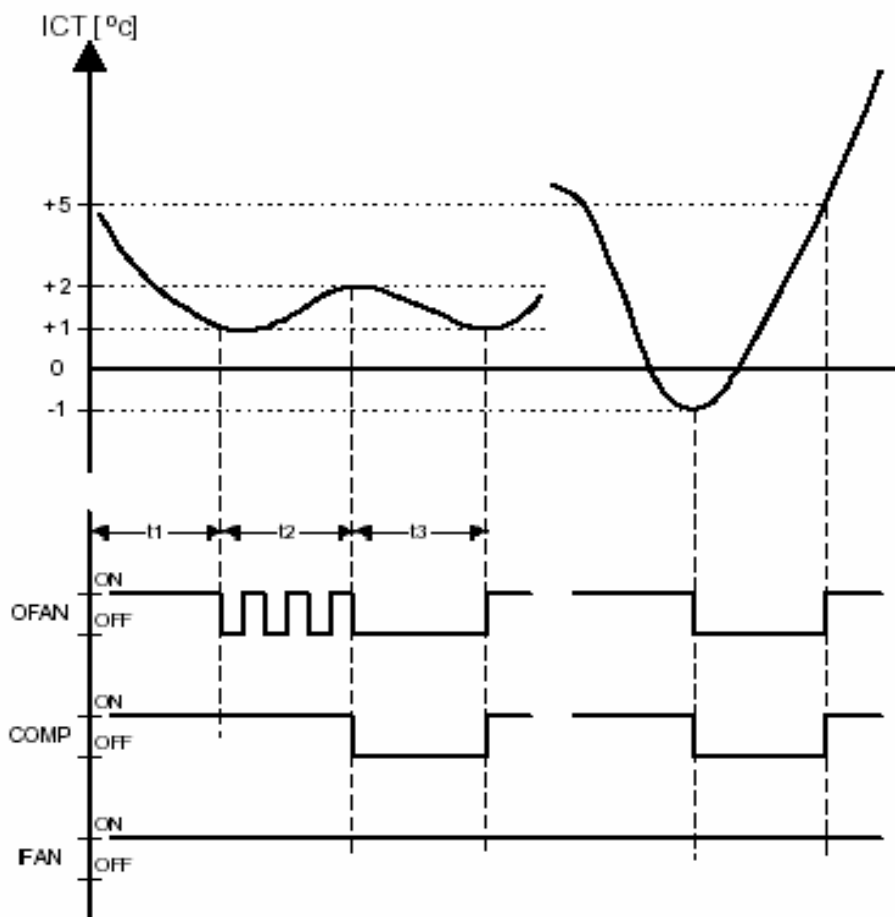

t1 = 5 min minimum for each COMP starting

t2 = OFAN cycling (alternate between ON and OFF every 30 sec) for 20 min maximum

t3 = COMP and OFAN stop for 10 min

2. Outdoor Coil High Pressure Protection

The out-coil high pressure protection prevent the build up of high pressure at the out-coil during cooling operation.

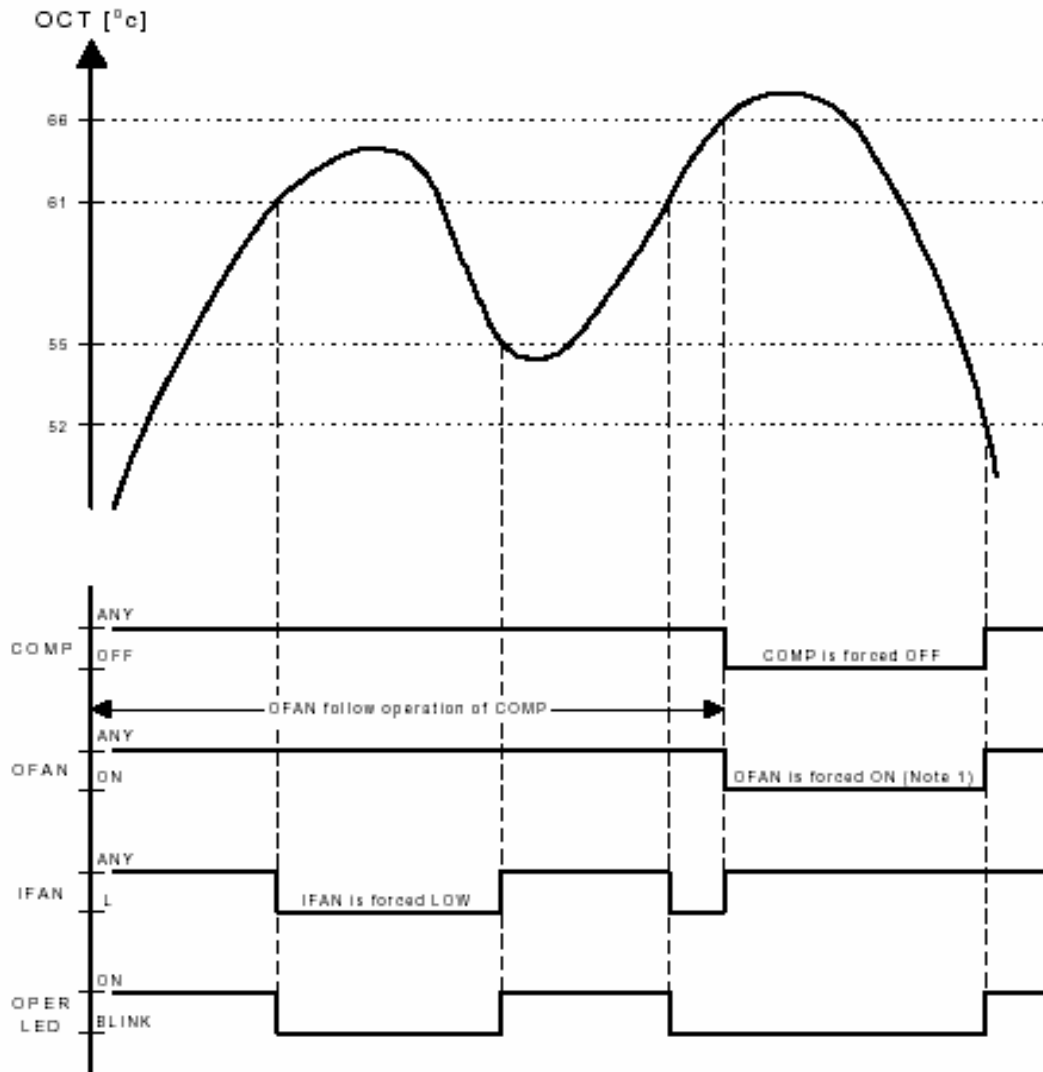

Note 1: In some applications, the outdoor fan and the compressor are controlled together by the COMP relay output from the controller. In this case, it will take more time for the out-coil to cool down during the high pressure protection, because the outdoor fan will be turned off with the compressor instead of working as in the graph above.

4-7 Protection Operations in Heat Mode

1. Outdoor Coil Deice Protection

The deice process is controlled by an Ice Detection Algorithm (IDA). The IDA is a unique control algorithm incorporated to maintain optimal utilization of the heat pump capacity, especially in below-zero outdoor temperature condition. The out-coil deicing will be activated not only by static temperature detection as normally done, but also while ice forming is detected on the out-coil.

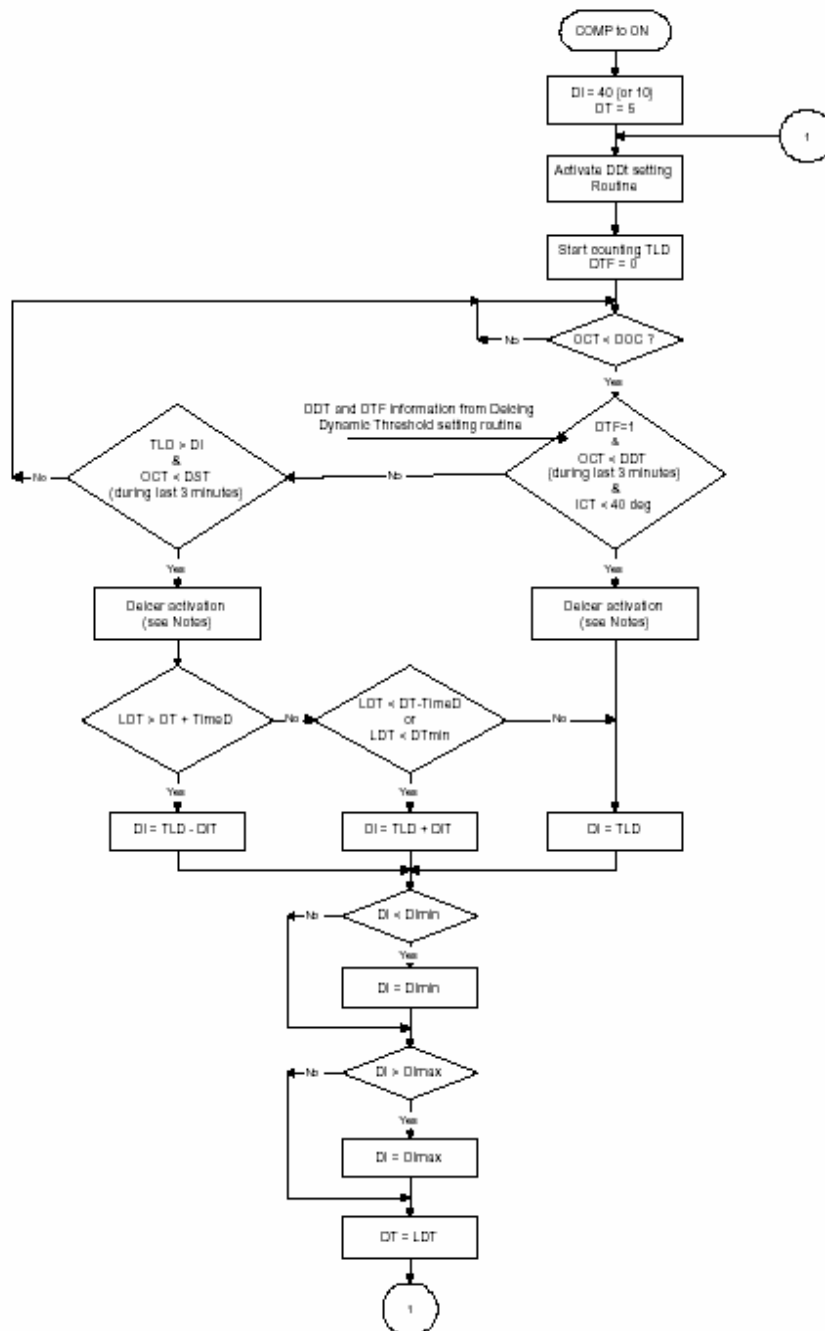

The following routine runs continuously while A/C is working in Heat Mode. The routine outputs Deicing Dynamic Threshold (DDT) and Deicer Threshold Flag (DTF) to the main Deicer routine.

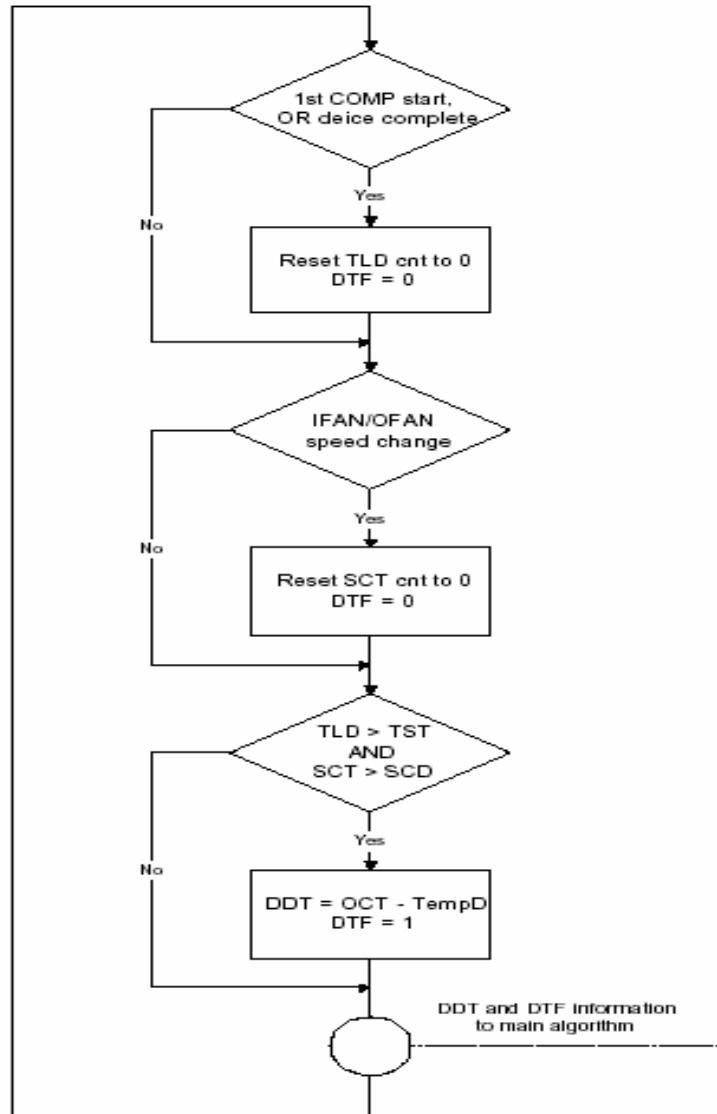

Explanation:

The "Ice Forming Detection" will be done by two algorithms –

- a. In Dynamic Temp Detection, the ice formation will be detected by
 - (i) Compare the OCT with a Deicing Dynamic Temperature Threshold, and
 - (ii) Detect the drop in ICT which accompany the ice formation.
- b. The Static Temp Detection will be done by comparing the OCT with a Deicing Static Temperature Threshold.

The Deicing Data Record is used to determine the time delay between two deicing cycles. In general, the time delay will be increased if the last deicing cycle can be completed quickly.

2. Indoor Coil High Pressure Protection in Heat Mode

The in-coil high pressure protection prevents the build up of high pressure at the in-coil during heating operation.

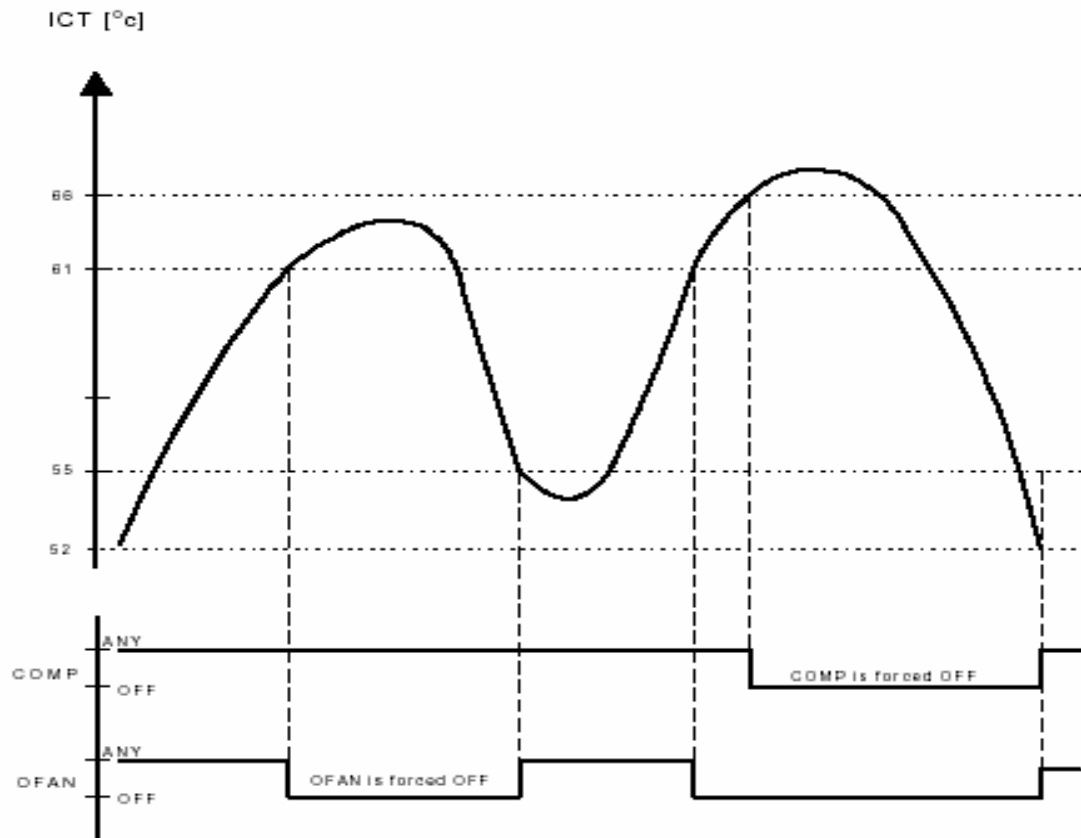

4-8 Sleep Function

Room temperature is automatically controlled to compensate for body temperature variations while sleeping. This mode of operation is designed for maximal comfort in both COOL and HEAT modes.

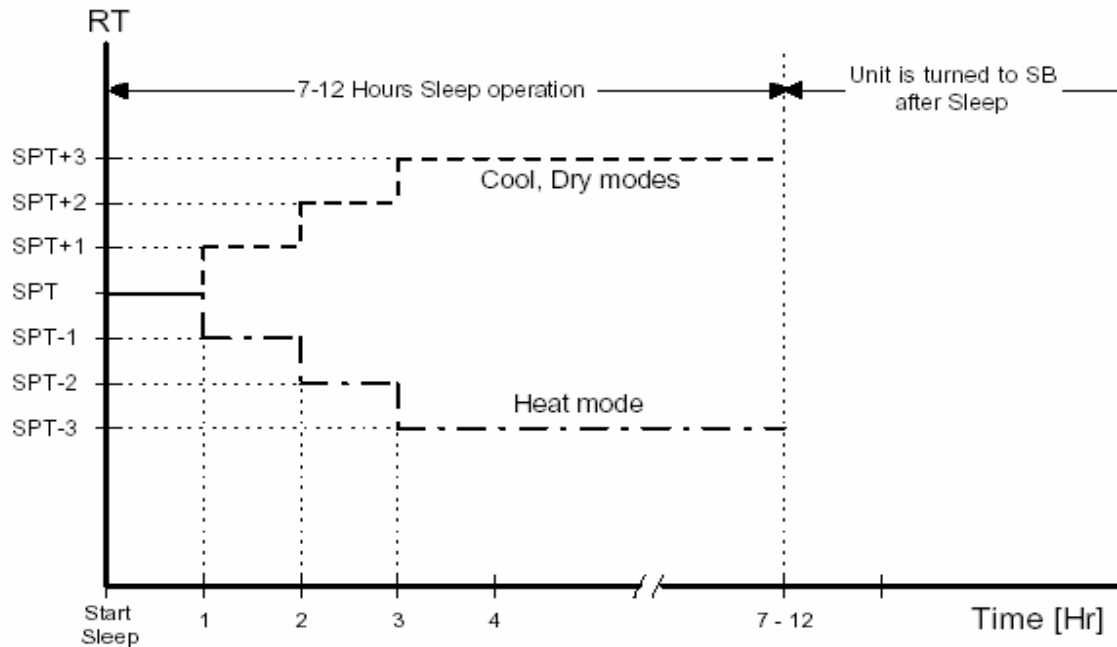

4-9 Daily Timer Function

There are 2 independent timers – ON Timer and OFF Timer. Unit can be programmed to be ON and OFF automatically at preset time everyday, by using a remote controller. The resolutions of the ON/OFF timers are 10 min.

4-10 IFEEL Function

There are 2 independent timers – ON Timer and OFF Timer. Unit can be programmed to be ON and OFF automatically at preset time everyday, by using a remote controller. The resolutions of the ON/OFF timers are 10 min.

5. TROUBLESHOOTING

5-1. Check before and after troubleshooting



WARNING

Hazardous voltage can cause **ELECTRIC SHOCK** or **DEATH**. Disconnect power or turn off circuit breaker before you start checking or servicing.

5-1-1. Check power supply wiring.

- Check that power supply wires are correctly connected to terminals **L** and **N** on the terminal plate in the indoor unit.

5-1-2. Check inter-unit wiring.

- Check that inter-unit wiring is correctly connected to the outdoor unit from the indoor unit.

5-1-3. Check power supply.

- Check that voltage is in specified range ($\pm 10\%$ of the rating).
- Check that power is being supplied.

5-1-4. Check lead wires and connectors in indoor and outdoor units.

- Check that coating of lead wires is not damaged.
- Check that lead wires and connectors are firmly connected.
- Check that wiring is correct.

5-2. Air conditioner does not operate.

5-2-1. Circuit breaker trips (or fuse blows).

A. When the circuit breaker is set to ON, it trips immediately. (Resetting is not possible.)

- There is a possibility of ground fault.
- Check insulation resistance.

If resistance value is $2M\Omega$ or less, insulation is defective ("NO").

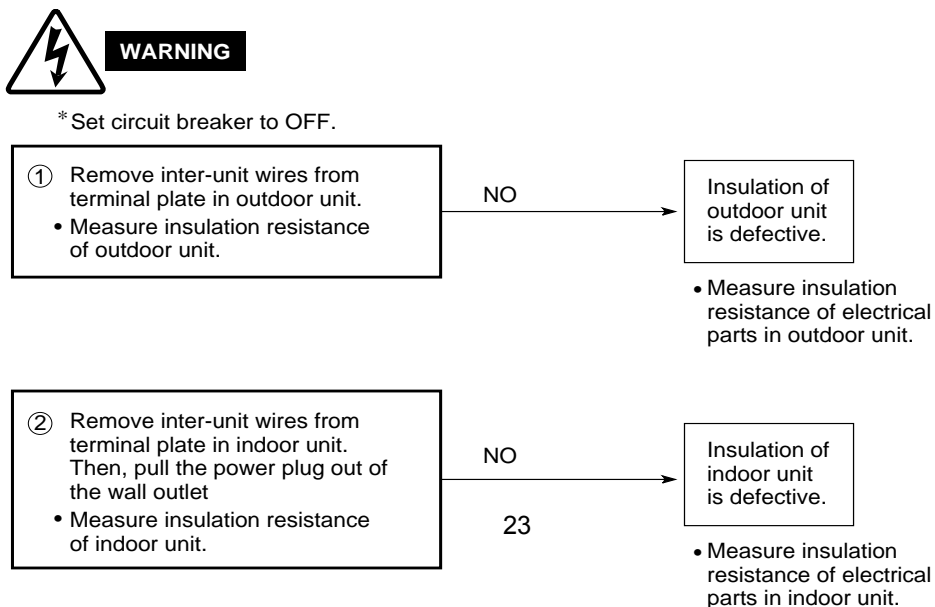

B. Circuit breaker trips in several minutes after turning the air conditioner on.

- There is a possibility of short circuit.

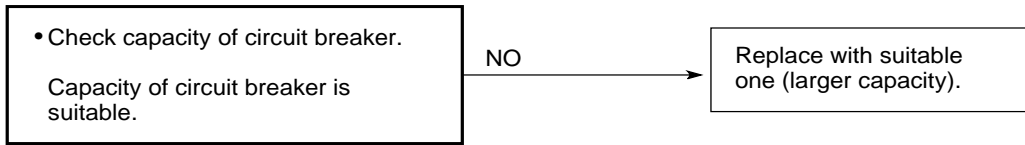

In case of Heating operation :

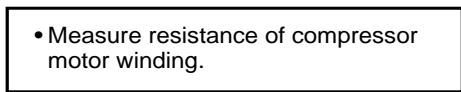

!5-2-2. Neither indoor nor outdoor unit runs.

A. Power is not supplied.

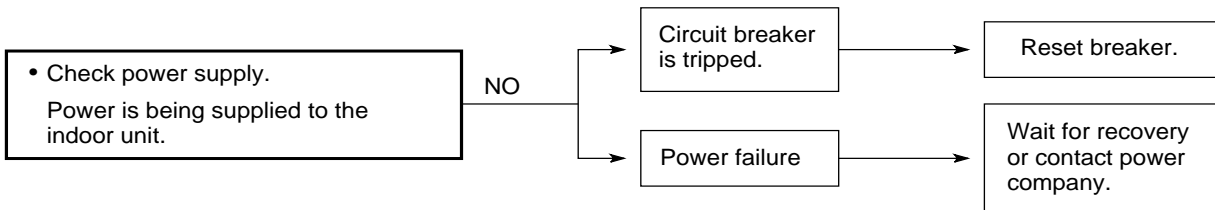

B. Check PUSH BUTTON switch in the indoor unit.

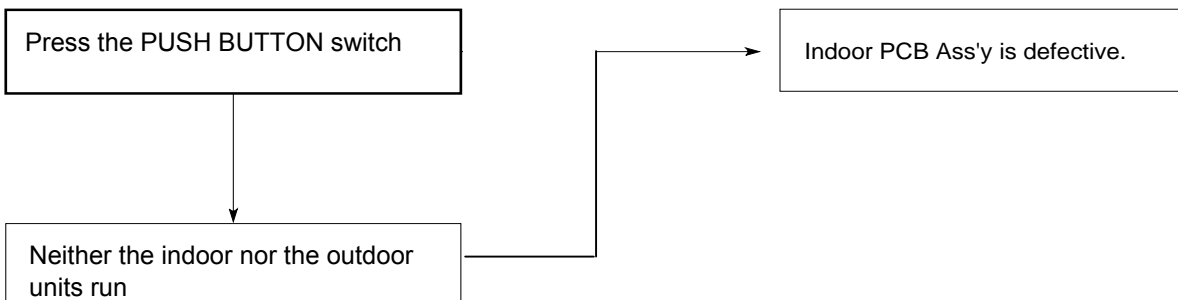

C. Check remote control unit.

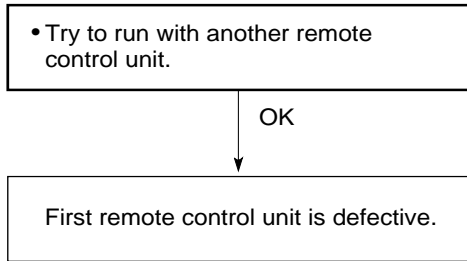

D. Check fuse on the indoor PCB Ass'y.

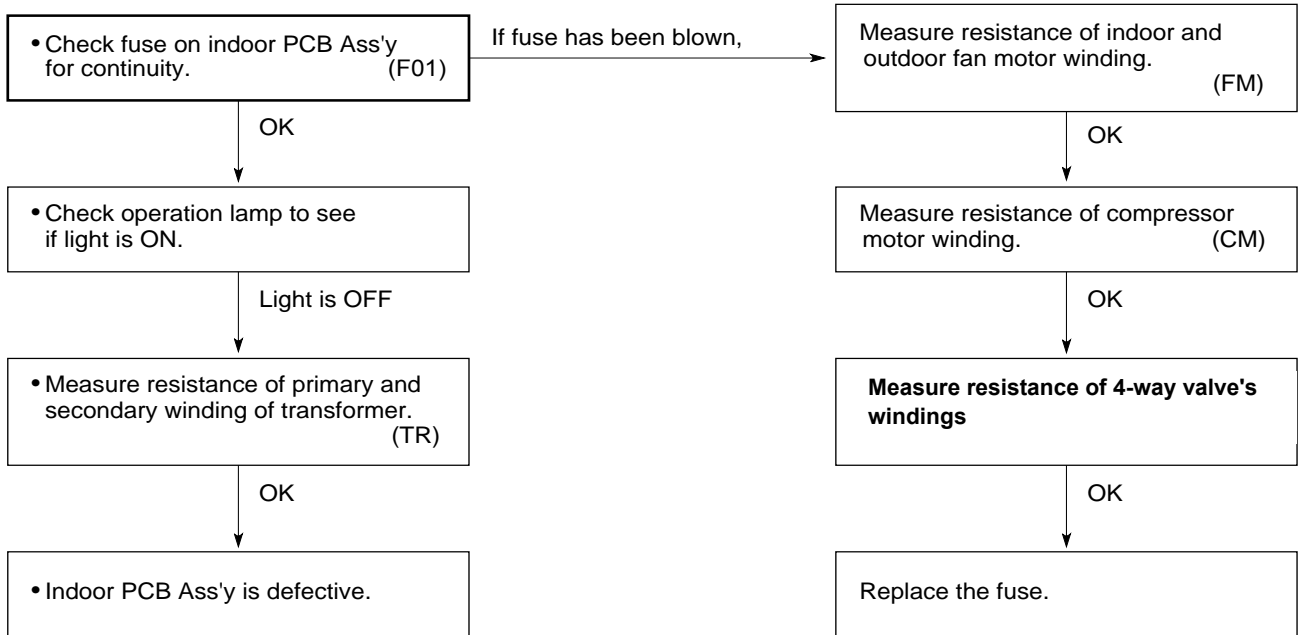

E. Check TIMER on the remote control unit.



5-2-3. Only outdoor unit does not run.

A. Check setting temperature.

COOL

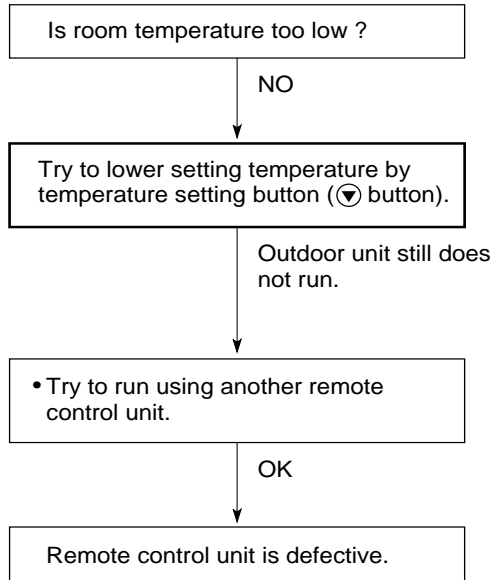

HEAT

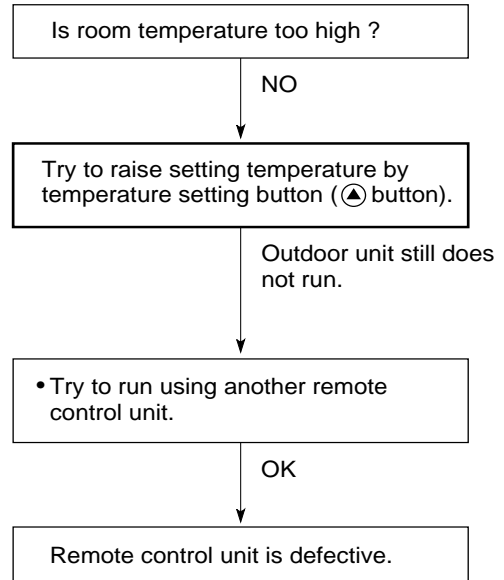

5-2-4. Only Indoor unit does not run.

- Indoor PCB Ass'y is defective.

5-3. Some part of air conditioner does not operate.

5-3-1. Only indoor fan does not run.

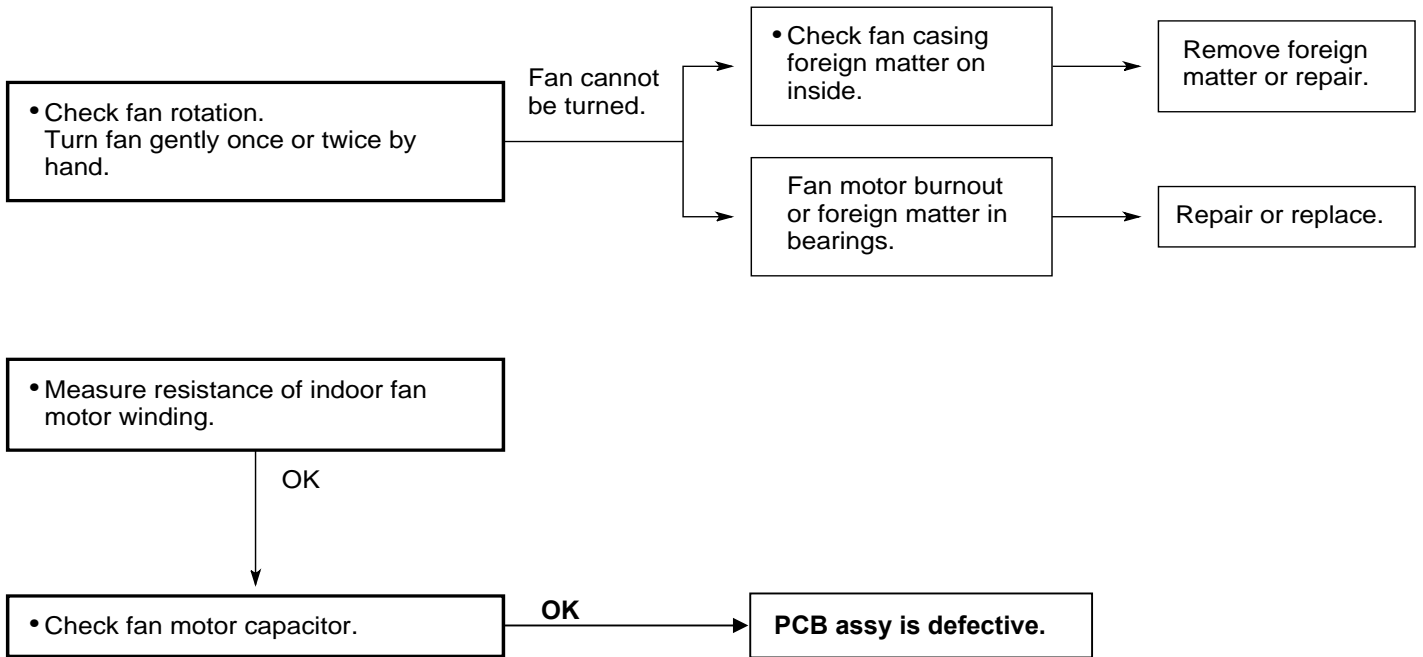

5-3-2 Only outdoor fan does not run.

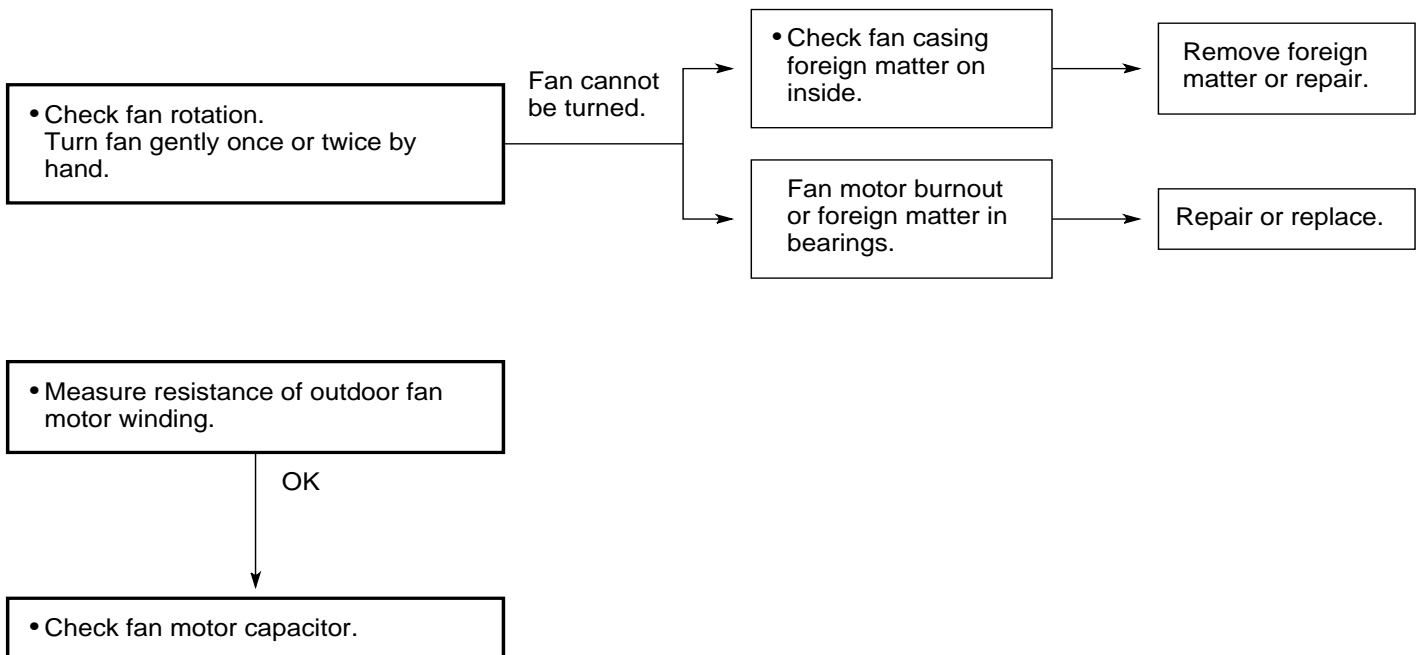

5-3-3. Only compressor does not run

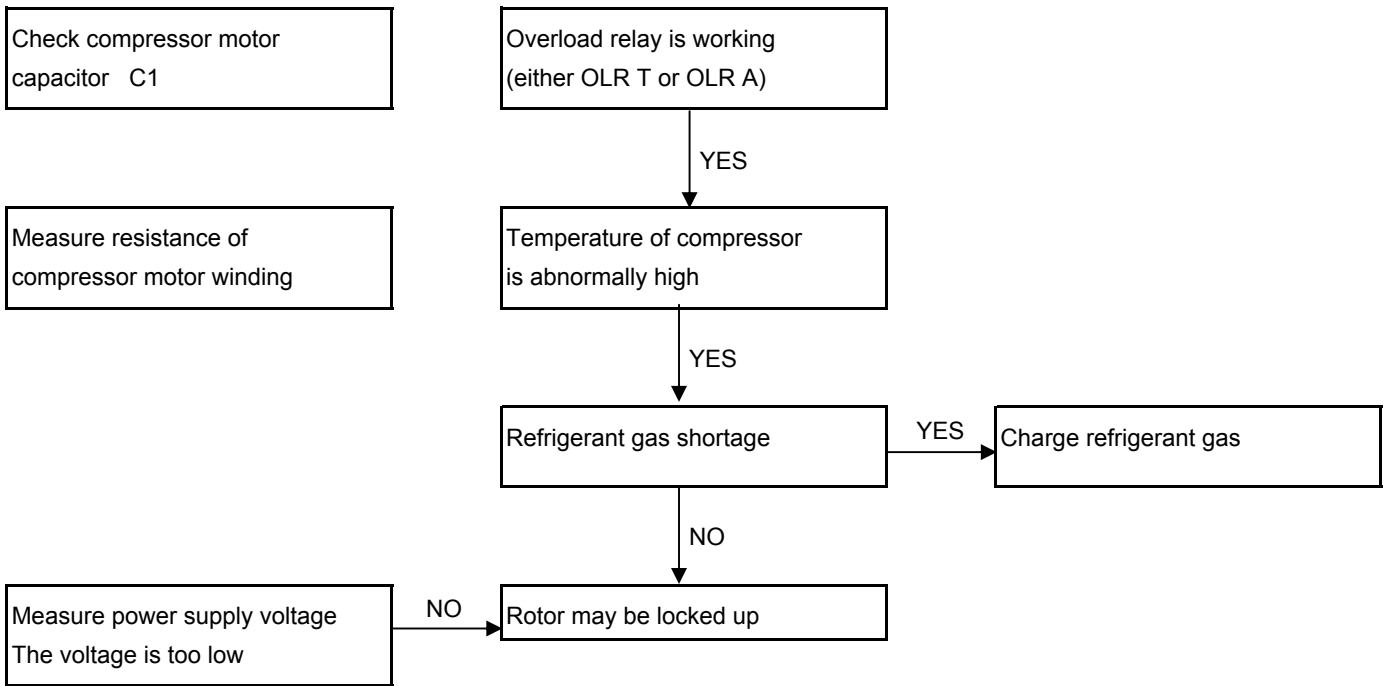

5-3-4. Compressor and outdoor fan do not run

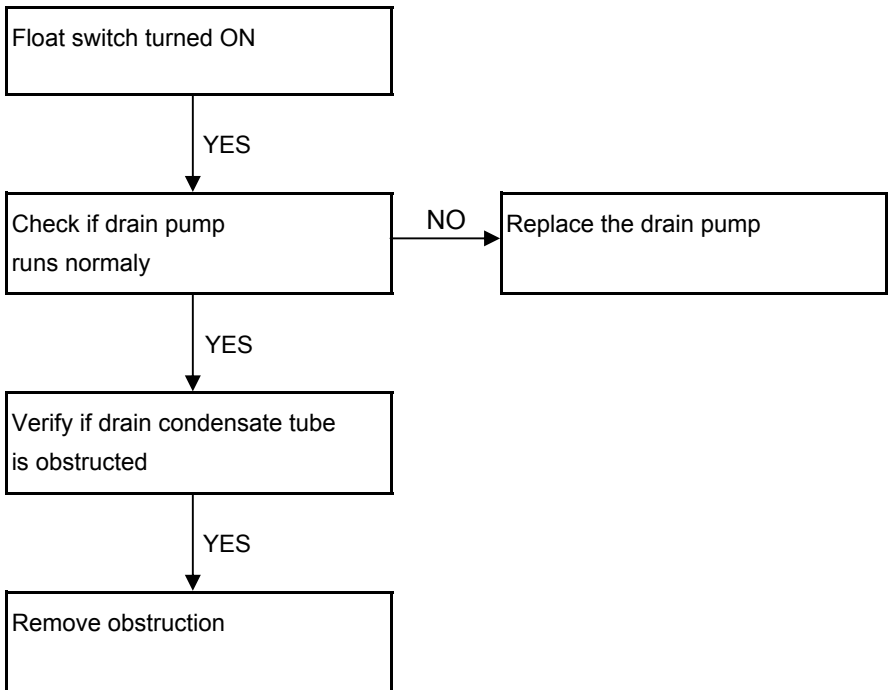

5-4. Air conditioner operates, but abnormalities are observed

5-4-1. Operation does not switch from HEAT to COOL (or COOL to HEAT)

Remote control unit
may be defective

Receiver in lamp ass'y
may be defective

Measure resistance of
4-way valve's winding

COOL to HEAT

Check voltage between
terminals N and 6 (230V AC)

OK

Outdoor PCB ass'y is defective

No voltage appears

Indoor PCB ass'y is defective

HEAT to COOL

Check voltage between
terminals N and 6 (230V AC)

5-4-2. Poor cooling or heating.

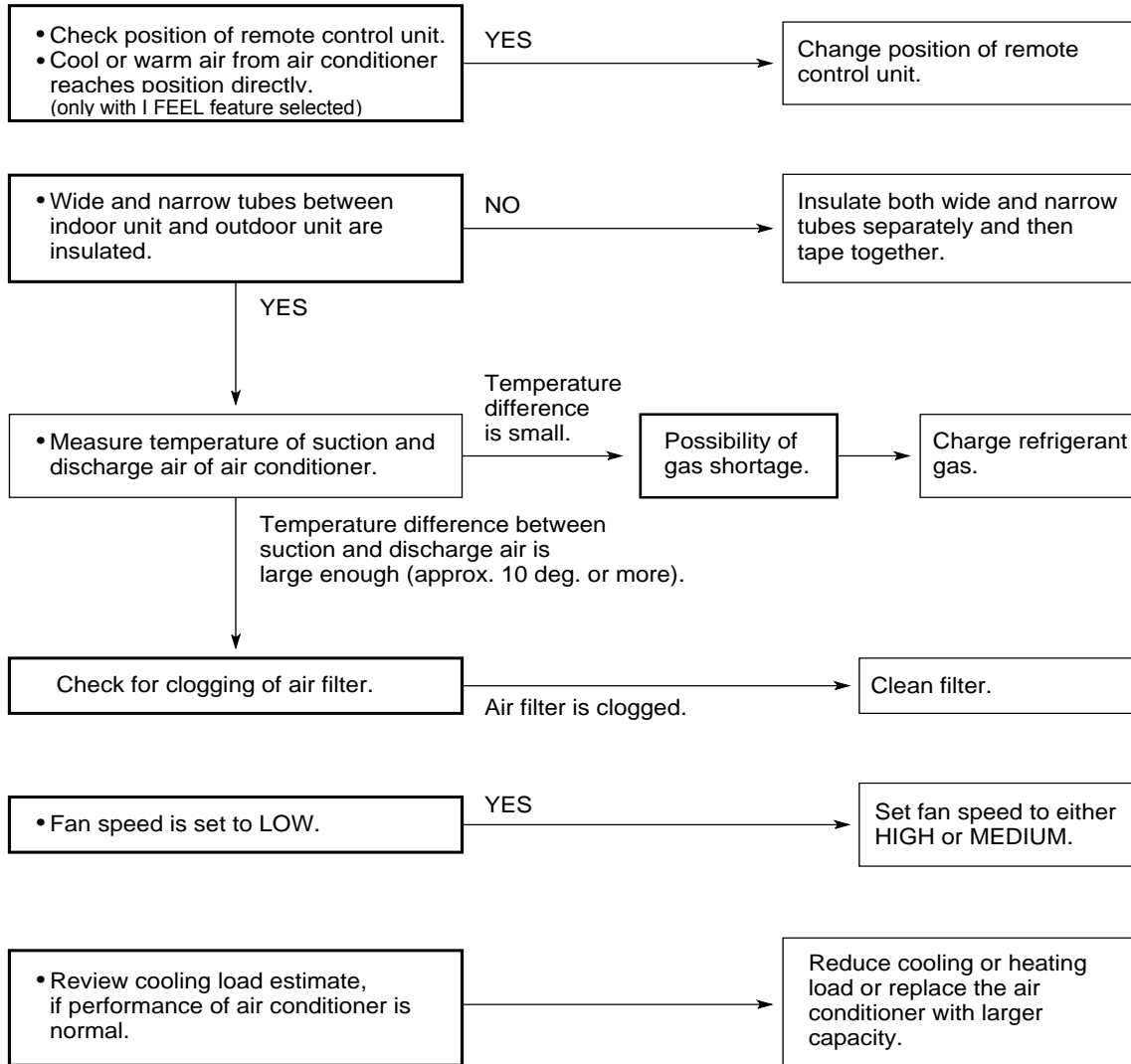

5-4-3. Excessive cooling or heating.

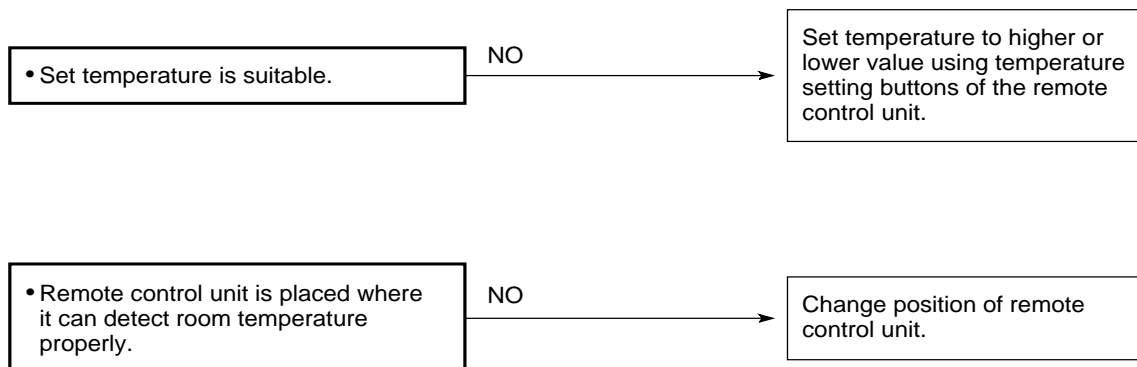

6-5 If a sensor is defective

6-5-1 ICT (indoor coil sensor) OCT(outdoor coil sensor) RAT (room ambient temperature) are defective.

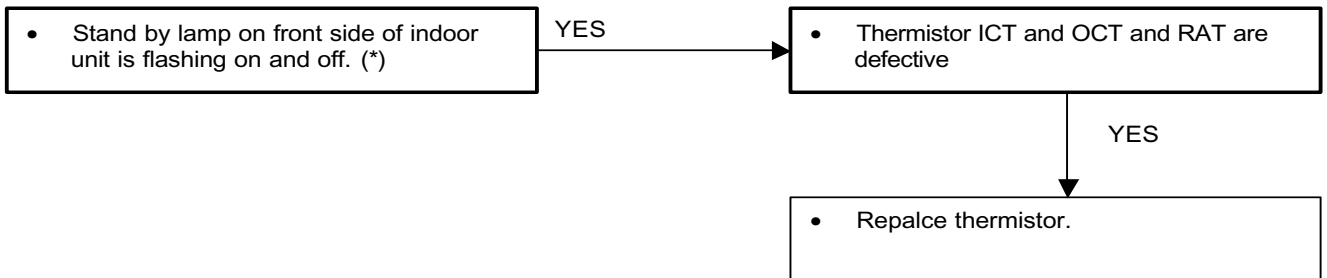

NOTE Alarm signal (*)

Stan by lampoon on the front side of the indoor unit will flash on and off when the thermistor is defective. At the same time the outdoor unit will stop. Indoor operate only for ventilation.

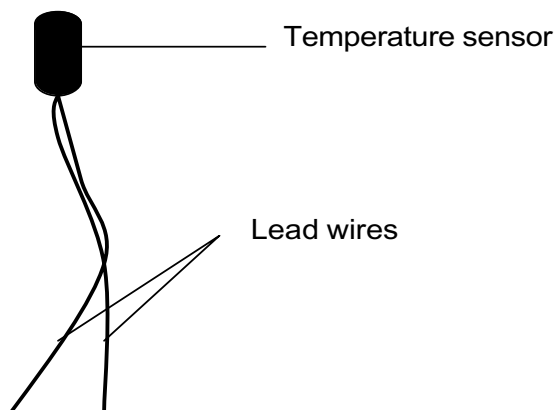

6. CHECKING ELECTRICAL COMPONENTS

6-1 Measurement of Insulation Resistance

The insulation is in good condition if the resistance exceeds $2M\Omega$

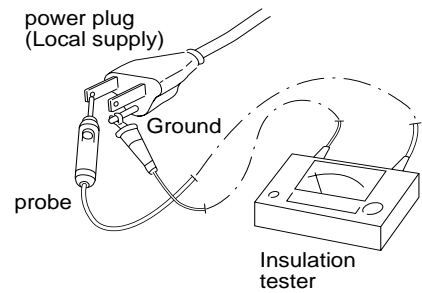

NOTE

The shape of the power plug may differ from that of the air conditioner which you are servicing.

Fig. 1

6-1-1. Power supply wires

Clamp the grounding terminal of the power plug with a lead clip of the insulation resistance tester and measure the resistance by placing a probe on both the two power terminals. (fig.1)

Then, also measure the resistance between the grounding and other power terminals. (fig.1)

6-1-2. Indoor Unit

Clamp a metallic part of the unit with the lead clip of the insulation resistance tester and measure the resistance by placing a probe on each terminal screw where power supply lines are connected on the terminal plate. (fig.2)

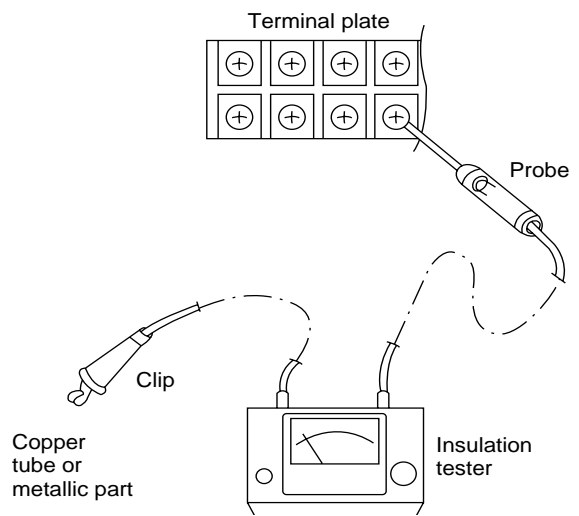

Fig. 2

6-1-3. Outdoor Unit

Clamp an aluminium plate fin or copper tube with the lead clip of the insulation resistance tester and measure the resistance by placing a probe on each terminal screw on the terminal plate. (fig.2) Note that the ground line terminal should be skipped for the check.

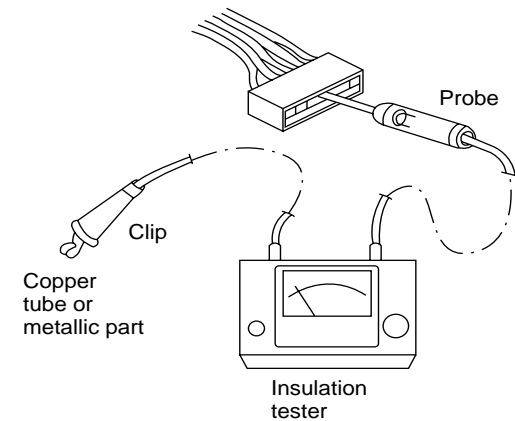

Fig. 3

6-1-4. Measurement of Insulation Resistance for Electrical Parts

Disconnect the lead wires of the desired electric part from terminal plate, capacitor, etc. Similarly disconnect the connector. Then measure the insulation resistance. (fig.3 and 4)

NOTE: Refer to electric wiring diagram

If the probe cannot enter the poles because the hole is too narrow then use a probe with a thinner pin.

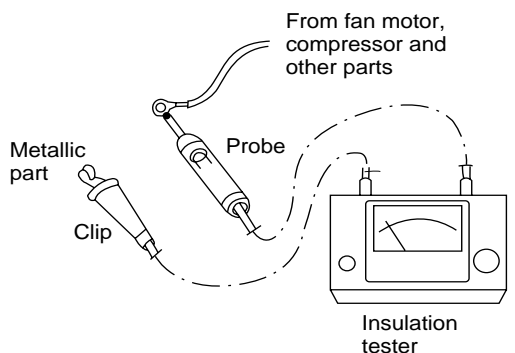

Fig. 4

6-2 Checking Continuity of Fuse on PCB Ass'y

Remove the PCB Ass'y from the electrical component box. Then pull out the fuse from the PCB Ass'y. (fig.5)

Check for continuity using a multimeter as shown in fig.6

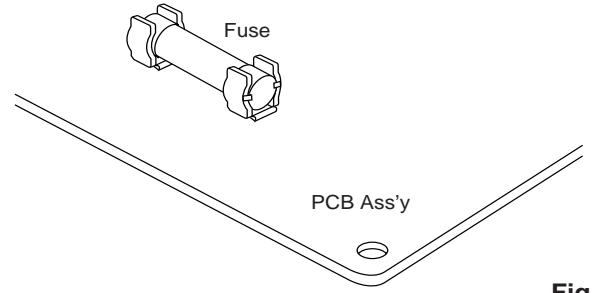

Fig. 5

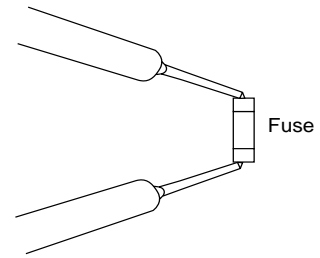

Fig. 6

6-3 Checking Motor Capacitor

Remove the lead wires from the capacitor terminals, and then place a probe on the capacitor terminals as shown in fig.7. Observe the deflection of the pointer, setting the resistance measuring range of the multimeter to the maximum value.

The capacitor is "good" if the pointer bounces to a great extent and then gradually returns to its original position.

The range of deflection and deflection time differ according to the capacity of the capacitor.

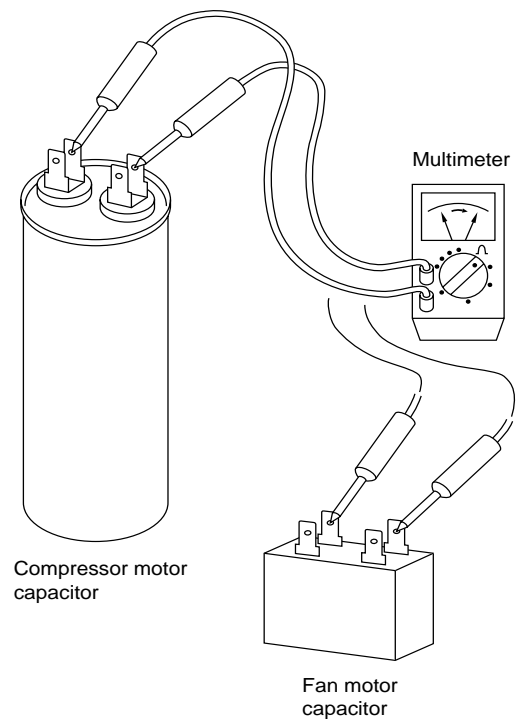

Fig. 7



R.D. 28 Reyrieux BP 131 - 01601 Trévoux CEDEX France
Tél. 04.74.00.92.92 - Fax 04.74.00.42.00
R.C.S. Bourg-en-Bresse B 759 200 728