



## USER MANUAL

## LINE SCALES

4BA/T SERIES

**Table of contents:**

1. General description	4
2. Technical data	5
3. Completion	5
4. Safety principles	6
5. Principles of user scale treatment	6
6. Scale external outputs	7
7. Connecting a computer, printer or label printer	8
7.1 Detailed LonG protocol description	9
7.2 Detailed EPL protocol description	11
8. Balance preparation to work	12
9. Operation principles	13
10. Balance test	14
11. Balance adjustment	14
12. Meter keys and indicators	14
13. Start-up	17
14. Weighing with tare	18
15. Scale menu	19
16. Menu navigation rules	20
17. Scale setup (SEtUP)	25
17.1 Scale calibration (CALib)	27
17.2 Autozeroing function (AutoZEr)	28
17.3 Weight unit selection (UnIt)	29
17.4 Serial port parameters setting (SErIAL)	30
17.5 Printout configuration (PrInt)	31
17.6 Setting backlight function (b_LIGHt)	33
17.7 Analog out configuration (AnALoG)	34
17.8 Entering reference zero value (ZErO)	35
18. Special functions description	36
18.1 Products and users database (Prod i USEr)	37
18.2 Pieces counting function (PCS)	41
18.3 Percentage weighing function (PErC)	42
18.4 Label choosing function (LAbEL)	43
18.5 Weighing animals function (LOC)	44
18.6 Constant tare memory function (tArE)	45
18.7 Maximum value indication function (UP)	47

---

18.8 Force measuring function ( <i>nEWton</i> )	48
18.9 Total weight function ( <i>totAL</i> )	49
18.10 Checkweighing function ( <i>thr</i> )	51
18.11 Setting date and time function ( <i>dAtE</i> )	54
18.12 Radio communication channel choice function ( <i>rF CHn</i> )	55
18.13 Charging accumulators function ( <i>bAttErY</i> )- option	56
18.14 Automatic switching off the scale function ( <i>AutoOFF</i> )	57
18.15 Statistical calculations function ( <i>StAt</i> )	58
18.16 Paperweight calculation ( <i>PAP</i> )	61
19. Maintenance and repairs of small defects	62
Declaration of Conformity	63
Appendix A	64

## 1. **General description**

Stainless line scales are designed for weighing of half carcasses, hanged on the hook with roll and moved on the rail. Scale built in the technological line is the segment of rail, where half carcasses are transported.

The scales are made of stainless steel and are designed to work in heavy conditions.

All balances are tested in respect of metrology. According to order, balances may be verified or calibrated.

EC verification (conformity assessment) of balances is required for special applications, mentioned in Ministry of Labour and Social Policy decree from 11.12.2003 (trade, tariffs, pharmacy recipes, medical and pharmaceutical analysis, packing of goods). For other applications it is recommended to replace verification with calibration.

Verified balances have the following verification features:

- protection stamps, located on balance meter and converters connection box (installed under the bearing surface).
- Office of Measures marks and green metrological mark, located on the rating plate.

EC verification is valid for 25 months from 1st of December of year, when the EC verification took place, under condition of stamp integrity.

Scales classification according to PKWiU: 29.24.23.

Certificates:



Certificate of type  
approval no. T7950



AXIS management System  
Certificate  
DIN EN ISO 9001:2000  
No. 78 100 6386

## 2. Technical data

Scale type	4BA300T	4BA600T
Maximal load (Max)	300kg	600kg
Readout unit (d)	100g	200g
Verification unit (e)	100g	200g
Minimal load (Min)	2kg	4kg
Tare range	-300kg	-600kg
Accuracy class	III	
Work temperature	-10÷40°C	
Weighing time	<3s	
Line lenght	0,5m	
Line diameter	φ48mm	
Display cable length	4m	
Supply	~230V, 50Hz, 8VA	
Protection step	meter IP65 sensor IP68	

## 3. Completion

Basic set consists of:

1. Scale sensor with line
2. Scale meter
3. Scale suspension
  - M12 screws ..... 4 pcs
  - M12 nuts ..... 16pcs
  - straps ..... 2pcs
4. RS232C joint (to computer)
5. User manual
6. Guaranty

#### 4. *Safety principles*

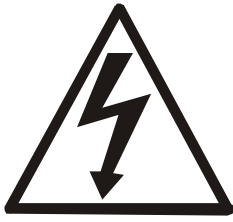

It is necessary to become familiar with safety principles shown below, which are necessary to avoid electric shock and damage of balance or connected devices.

- Repairs and necessary adjustments must be performed by qualified personnel only.
- To avoid fire hazard, use only typical supply cable, and supply voltage must be consistent with technical data.
- For the balance supply use the socket with protective contact.
- Do not use balance when the cover is removed.
- Do not use balance in explosive atmosphere.
- Do not use balance in locations with high humidity, when the cover does not have special protections (NAN types).
- In case of damage suspicion, switch the balance off and do not use it until it is tested in professional service company.

#### 5. *Principles of user scale treatment*



According to valid regulations regarding natural environment protection do not place used electronic devices in containers with common waste.

- Used balance after operation period may be transferred to units authorized for collection of used electronic equipment, or to place of purchase.

## 6. Scale external outputs

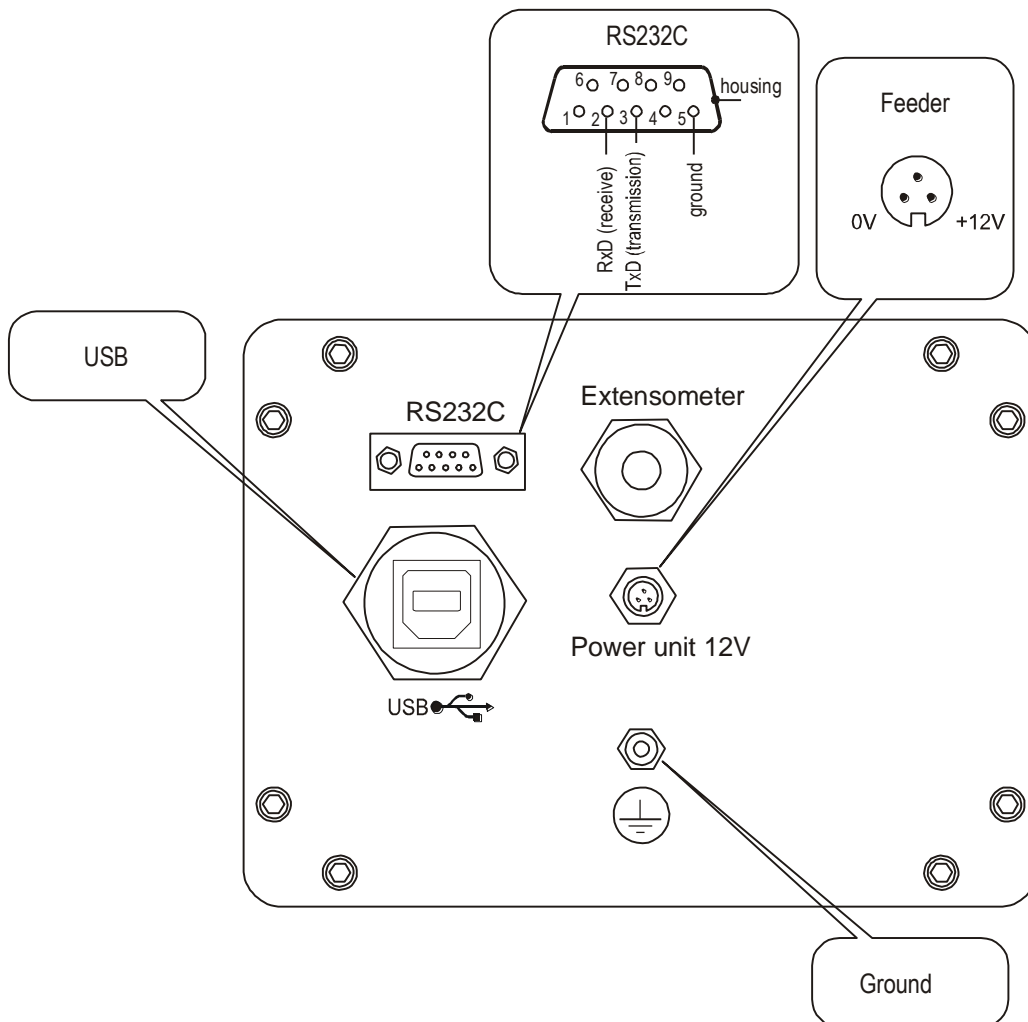

Separate ground connection (scales in stainless steel version) must be connected using additional conductor.

Extensometers are connected permanently.

## 7. **Connecting a computer, printer or label printer**

The scale is equipped with RS232C, which can be used to connect external devices such as computer or a printer.

When cooperating with computer, the scale sends weighing result after initialize signal from computer or after pressing  key on the scale.

When cooperating with a printer data is send automatically after result stabilisation, but next transmission is possible after removing previously weighted sample.

When cooperating with label printer after pressing  key, the scale sends instructions set for the label printer. Label number 0001, hour, data (if the clock is installed and on) and nett weight. During transmission *LabEL* communicate is displayed.

The way of sending data and transmission parameters is set using *SErIAL* special function.

Set of send data is set using special function *Print*.

The following data can be send:

- Header (scale type, Max, d, e, serial number),
- Operator identification number,
- Successive printout number (measurement),
- Identification number or product bar code,
- Number of pcs (PCS function only),
- Single detail mass (PCS function only),
- Nett weight,
- Tare (package mass),
- Gross weight,
- Total mass (Total function only).

If the scale is equipped with two serial joints *Print* function is set independently for both interfaces.

Computer must have a special program for cooperation with data from a scale.

Dedicated programs are also offered by AXIS.

Except RS232C joint, the scale can be equipped with USB or Wi-Fi interface.

Needed controllers and instruction can be found on a CD supplied with Axis scales.



## 7.1 Detailed LonG protocol description

Communication parameters: 8 bits, 1 stop bit, no parity, baud rate 4800bps,

- initialising signal (data send order) – correspond to press  key

Computer→Scale: **S I** CR LF (53h 49h 0Dh 0Ah),

Scale→Computer: scale response according to description below (16 bytes):

Byte	1	-	sign „-“ or space
Byte	2	-	space
Byte	3÷4	-	digit or space
Byte	5÷9	-	digit, decimal point or space
Byte	10	-	digit
Byte	11	-	space
Byte	12	-	k, l, c, p or space
Byte	13	-	g, b, t, c or %
Byte	14	-	space
Byte	15	-	CR
Byte	16	-	LF

### Attention:

Network number different than zero (*SERIAL / nr* function) changes scale working mode: communication with a computer is possible after logging the scale in with 02h scale number command. To log the scale out use 03h command.

For example: Using a program to test RS232 interface ( program is available in [www.axis.pl / programy komputerowe](http://www.axis.pl/programy/komputerowe) ) for scale number 1 please write: \$0201 to log in, then SI, and write: \$03 to close communication.

- Asking about scale presence in system (testing scale connection with computer):  
Computer→Scale: **S J** CR LF (53h 4Ah 0Dh 0Ah),  
Scale→Computer: **M J** CR LF (4Dh 4Ah 0Dh 0Ah),
- Displaying a inscription on scale's display (text communicate from computer):  
Computer→Scale: **S N n n X X X X X X** CR LF, nn-displaying time in seconds; XXXXXX-6 signs to display  
Scale→Computer: **M N** CR LF (4Dh 4Eh 0Dh 0Ah),
- Scale tarring (calling  $\rightarrow T \leftarrow$  key press) :  
Computer→Scale: **S T** CR LF (53h 54h 0Dh 0Ah),  
Scale→Computer: without response,
- Scale zeroing (calling  $\rightarrow 0 \leftarrow$  key press):  
Computer→ Scale: **S Z** CR LF (53h 5Ah 0Dh 0Ah),  
Scale  $\rightarrow$ Computer: without response,
- Scale turning on / off (calling I/⏻ key press):  
Computer→ Scale: **S S** CR LF (53h 53h 0Dh 0Ah),  
Scale  $\rightarrow$ Computer: without response,
- Entering to special function menu (calling *MENU* key press):  
Computer→ Scale: **S F** CR LF (53h 46h 0Dh 0Ah),  
Scale  $\rightarrow$ Computer: without response,

- Setting threshold 1 value (option):  
 Computer → Scale: **S L D1...DN CR LF** (53h 4Ch D1...DN 0Dh 0Ah)  
 D1...DN – threshold value, maximum 8 characters („-” – negative value, digits, dot – decimal separator), number of digits after dot should be the same as on scale display,  
 Scale → Computer: without response,  
 Example:
  - in order to set low threshold 1000g in scale B1.5 (d=0.5g) the following order should be sent:  
 S L 1 0 0 0 . 0 CR LF (53h 4Ch 31h 30h 30h 30h 2Eh 30h 0Dh 0Ah),
  - in order to set low threshold 100kg in scale B150 (d=50g) the following order should be sent:  
 S L 1 0 0 . 0 0 CR LF (53h 4Ch 31h 30h 30h 2Eh 30h 30h 0Dh 0Ah),,
- Setting threshold 2 value (option):  
 Computer → Scale: **S H D1...DN CR LF** (53h 48h D1...DN 0Dh 0Ah),  
 D1...DN – threshold value, maximum 8 characters  
 Scale → Computer: without response.
- Setting threshold 3 value (option):  
 Komputer → Waga: **S M D1...DN CR LF** (53h 4Dh D1...DN 0Dh 0Ah),  
 gdzie: D1...DN – threshold value, maximum 8 characters  
 Waga → Komputer: without response.

**Connecting cable WK-1** (scale – computer / 9-pin interface):

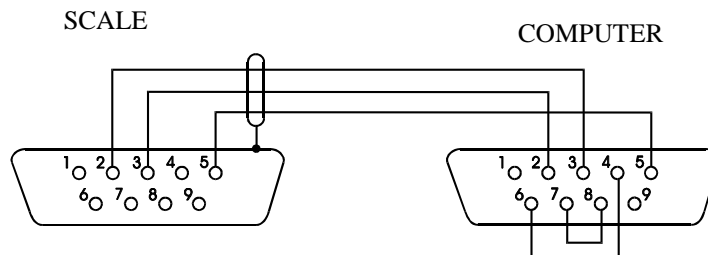

**Connection cable WD-1** (connects scale with AXIS printer):

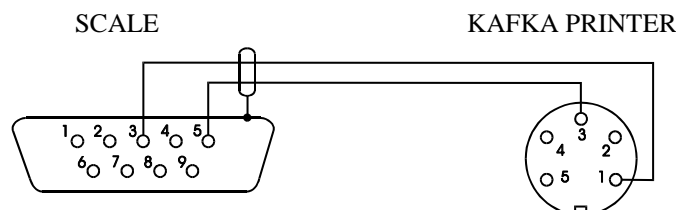

**Setting of internal switches of AXIS printer:**

SW-1	SW-2	SW-3	SW-4	SW-5	SW-6	SW-7	SW-8
on	off	on	off	off	on	off	off

## 7.2 Detailed EPL protocol description

Transmission parameters: 8 bits, 1 stop bit, no parity, baud rate 9600bps,

- After using  key in scale:
- Scale→Label printer : set of instruction in EPL-2 language that initialize label printing:

US	- Steering instruction
FR"0001"	- Label number define instruction
?	- Instruction that starts list of variable signs
mm:gg	- 5 signs: minutes:hour
rrrr.mm.dd	- 10 signs: year.month.day
masa	- 10 signs: scale indication+ mass unit
P1	- Steering instruction

### **Attention:**

1. Except variable signs constant signs can also be inscribed e.g. factory name, product name and so on.
2. In standard only one label pattern is possible to printout (number 0001). Using bigger amount of patterns (other label numbers) is possible thanks to *LABEL* special function.
3. To achieve label printout, label printer must have inscribed label pattern (label pattern is created on computer and using computer it is saved to label printer memory). Label pattern is designed by ZEBRA DESIGNER program which is supplied together with label printer.

Scales parameters and transmission protocol must correspond to label printer type.

## 8. Balance preparation to work

1. Unpack the balance.
2. Built-in the scale into horizontal line sector, in place not subjected to mechanical vibrations and strong air movements.
3. Using M12 nut set the line sector precisely in axis of existing line with  $3^{\pm 1}$ mm intervals from both sides.
4. Connect the ground wire to scale (label on the scale indicates where it should be connected) and ground the rest of existing line.

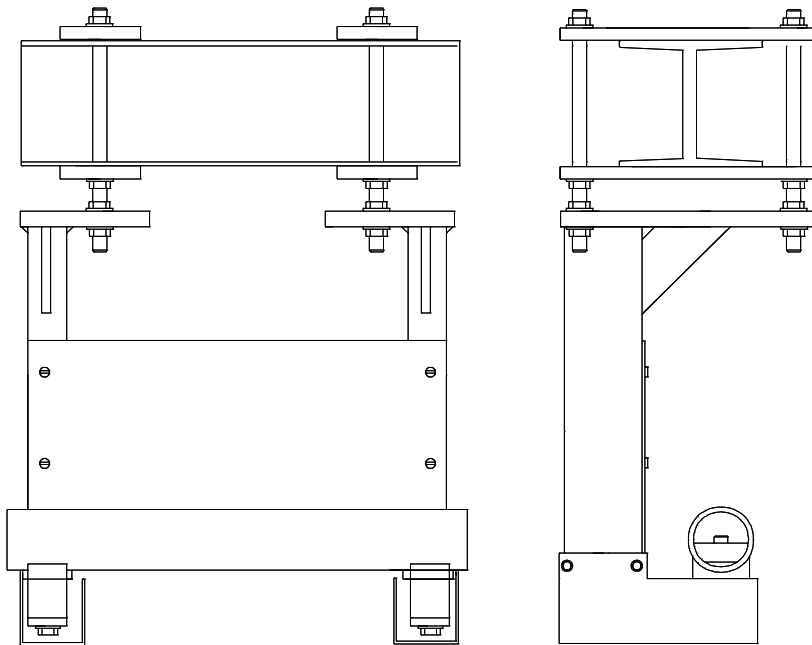

5. Mount read-out module in convenient place.

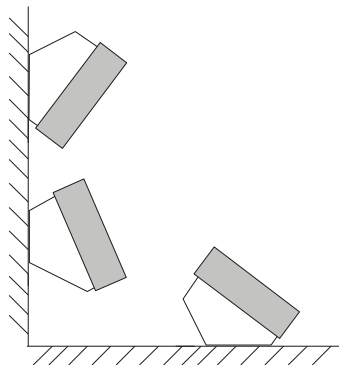

6. Connect the supply cable plug to socket with protective contact, when balance is unloaded.

## 9. Operation principles

1. Before each measurement the balance should be properly zeroed, which is signalled by "→0←" indicator. If the zero indication is not shown when the balance is unloaded, or "----" is displayed, press the "→0←" key.
2. The balance enables tare setting in the whole measuring range. It is performed by pressing "→T←" key.
3. Weighed mass should be placed in the platform centre.



***Do not drop weighed objects on the platform.***



***Do not overload the balance over 20% of maximum load.***

4. The weighing result should be read during the "┌┐" indicator lighting, which indicates the result stabilization.
5. When there is no weighing, but the balance should be ready for operation, it may be switched off by I/⏻ key. It causes the balance reading system deactivation end entering the standby mode. Balance turning on is performed by pressing "I/⏻" key.
6. Protect the balance from dust, aggressive dusts and liquids. For cleaning purposes use water and dry it.

## 10. Balance test

During balance operation, in order to confirm its efficiency, it is recommended to check the weighing precision by putting an object of exactly known weight before and after series of measurements. For testing of verified balances use weight standard, having valid standardization certificates. In case of allowable measurement error exceeding contact authorized service company to perform balance adjustment.

## 11. Balance adjustment



*Balance adjustment must be performed by authorized service company only, as it is connected with necessity of seals breaching, required for warranty purposes.*

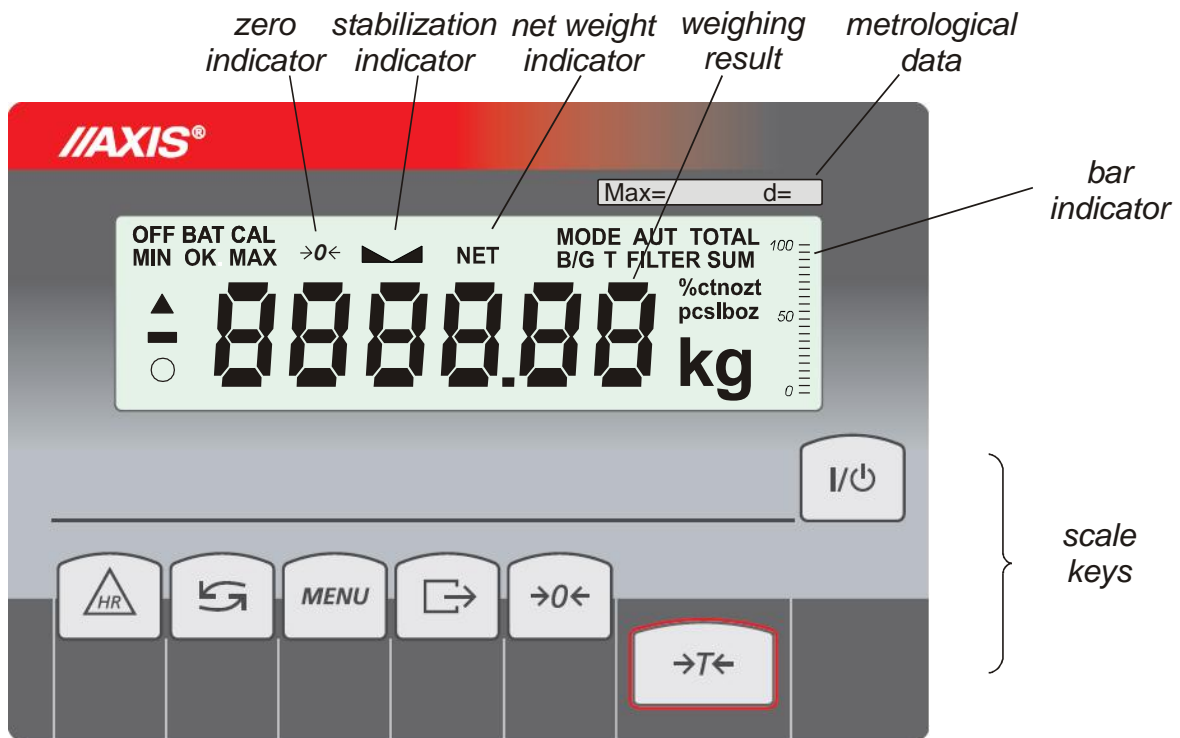

## 12. Meter keys and indicators

LCD display version:



- |             |      |   |   |
|-------------|------|---|---|
| Keys:       | I/⏻  | - | switch-on / switch-off (standby),                               |
| "           | →T←  | - | tare, menu position confirmation, next digit (when inscribing), |
| "           | →0←  | - | zeroing, scrolling menu, increasing digit (when inscribing),    |
| "           | ☞    | - | result printout, decimal point (when inscribing),               |
| "           | MENU | - | menu,   |
| "           | ↻    | - | function switch: special function/weighing,                     |
| "           | HR   | - | temporary high resolution indication,                           |
| Indicators: | →0←  | - | zero indicator (unloaded scale),                                |

---

"		- result stabilization indicator,
"	NET	- net weight (after using →T← key),
"	MODE	- special function menu turning on indicator
"	B/G	- gross weight (after using TARE and ↶↷ key)
"	AUT	- autotare function on,
"	T	- tare memory function on,
"	TOTAL, FILTER, SUM	- special functions indicators,
"	%, ct, n, g/m2, lb,mg	- unit indicators,
"	pcs	- pieces counting indicator,
"	n	- measurements quantity indicator (total function),
"	OFF	- scale turned off  (standby)
"	MIN	- weighing result under threshold I ( <i>thr</i> function),
"	OK	- weighing result between threshold I and II,
"	MAX	- weighing result above threshold II,
	BAT	- battery discharge indicator,
	Δ, O	- ACtIV function indicator,
bar	indicator	- scale load indicator (0-100%)

**LED display version:**

klawisz	I/⏻	- switch-on / switch-off (standby),
"	→T←	- tare, menu position confirmation, next digit (when inscribing),
"	→0←	- zeroing, scrolling menu, increasing digit (when inscribing),
"	➡	- result printout, decimal point (when inscribing),
"	MENU	- menu,
"	↻	- function switch: special function/weighing,
"	HR	- temporary high resolution indication,
wskaźnik	→0←	- zero indicator (unloaded scale),
"	▲	- result stabilization indicator,
"	NET	- net weight (after using →T← key),
"	W1	- first range on in two-range scale,
"	W2	- second range on in two-range scale,
"	HOLD	- indication „locked” (concerns LOC and UP functions),
"	FUNC	- special function turned on,
"	PCS	- pieces counting,
"	g, kg, lb, unit	- weight unit (g-gram, kg-kilogram, lb-pound, unit – other),
"	MIN	- weighing result under threshold I (thr function),
"	OK	- weighing result between threshold I and II,
"	MAX	- weighing result above threshold II,

During inscribing numerical values needed during using special functions keys have special functions.



## 13. Start-up

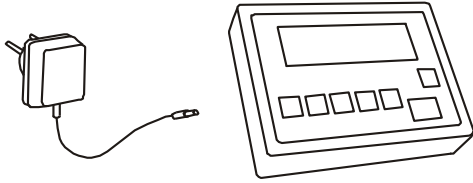

Leave the pan empty, plug a scale to the mains with a ground contact. The scale proceeds with following start-up actions:

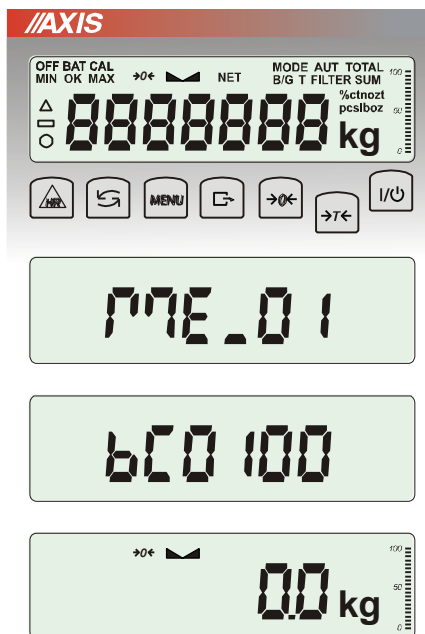

Display test.

Meter type displaying

Program version

The scale is now ready to work.

### Attention:

Displaying program version means positive result of all tests.

## 14. Weighing with tare

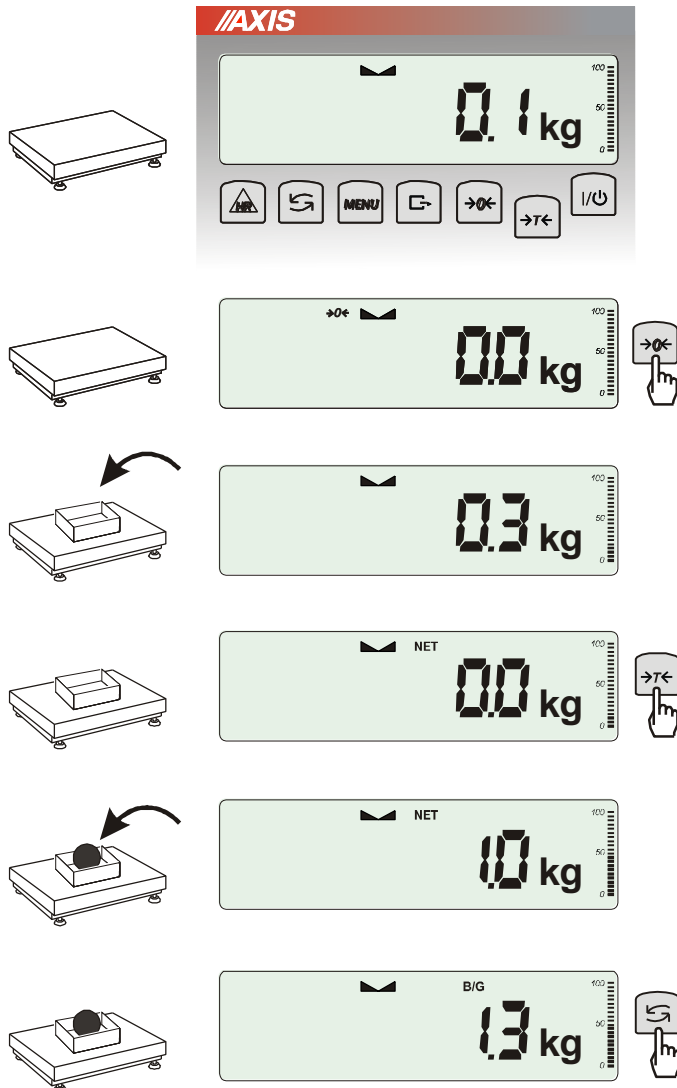

If the scale is not loaded and →0← indicator doesn't indicate, press →0← key.

Zero indication and →0← indicator mean that the scale is ready to work.

After putting container (package) tare the scale using →T← key. NET indicator will show up.

Put on weighted object and readout net weight (NET indicator shows that scale indicates net weight).

In order to readout gross weight press ↻ key (B/G indicator shows that scale indicates gross weight). Press again ↻ key in order to come back to net indications.

## 15. Scale menu

All scales except for basic metrological functions: weighing and taring, have many special functions and configuration options.

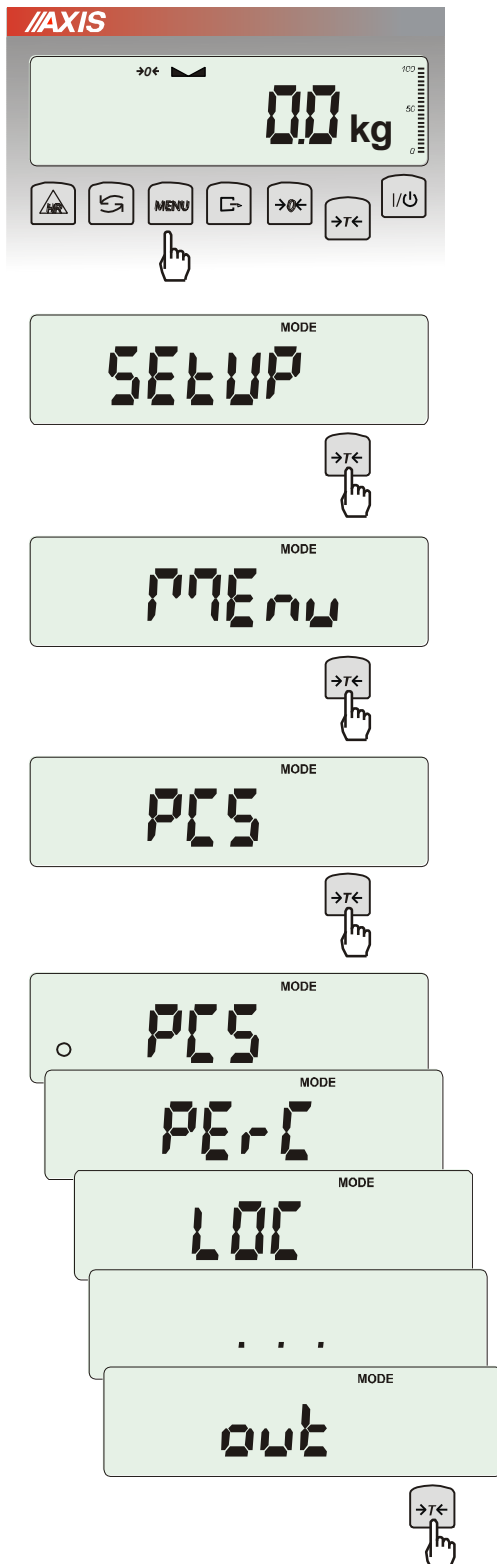

In order to ease using functions user can create his own (personalized) menu.

*Creating personalized menu:*

In „out of the box” scale after pressing *MENU* key only *SEtUP* option (it contains all configuration options) is available.

One of the configuration options is *Menu* that is used to create personalized menu.

To add a function to personalized menu press →T← key when the function is indicating.

Chosen function is indicated with „o” sign on the left side of display.

After adding all necessary functions press *out* in order to come back to weighing mode. User now after pressing *MENu* key has access to selected earlier functions and to *SEtUP* option. *dEFAULT* option is used to set factory settings.

## 16. Menu navigation rules

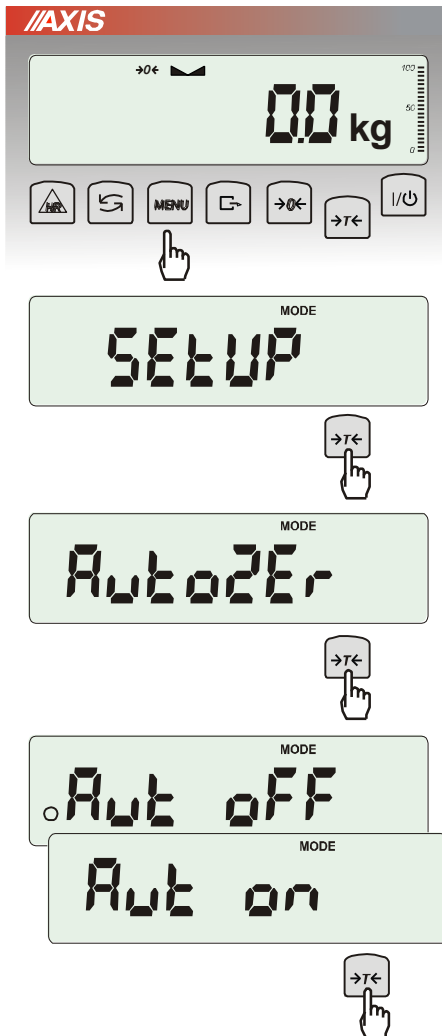

### Choosing menu options:

First position of scale menu shows up after pressing *Menu* key. The position is displayed for about 7 seconds and then the scale sequentially displays next menu positions.

Choosing menu position (option) is done by pressing  $\rightarrow T \leftarrow$  key when it is displayed on the screen.

After choosing position (option) usually several options show up:

- on* – turning on selected option,
- OFF* - turning off,
- out* – out to menu.

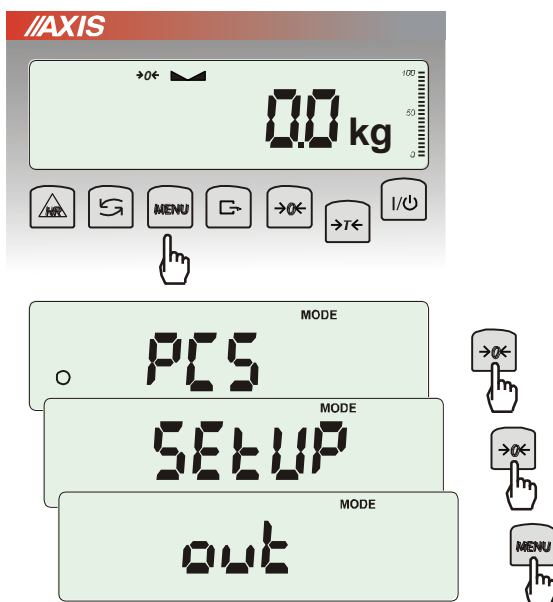

### Accelerated working with menu:

Menu first position is displayed for about 7s. During this time user can view next positions by using  $\rightarrow T \leftarrow$  key (or  $\rightarrow 0 \leftarrow$ ).

Immediate out to previous menu level is done by using *Menu* key.

↻ key working method:

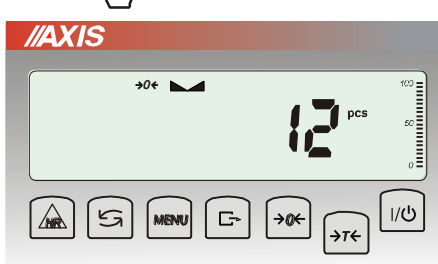
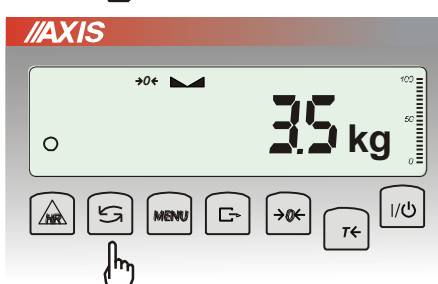
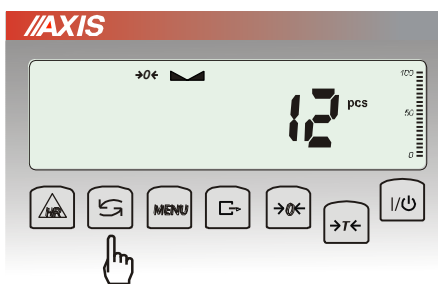
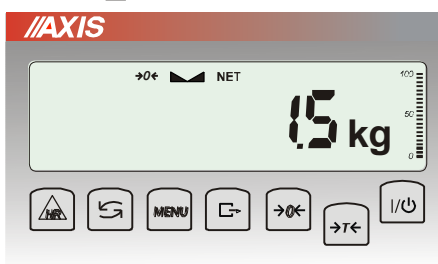
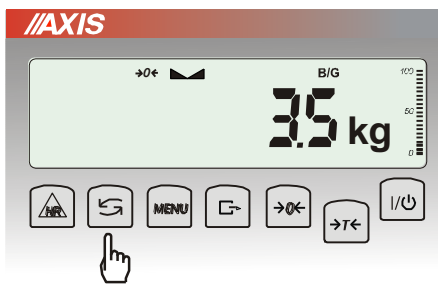
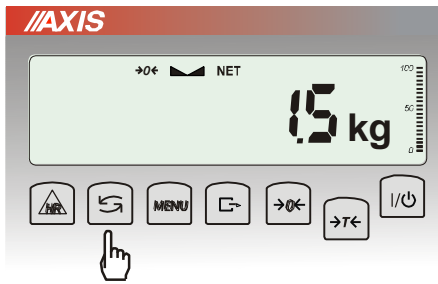

During standard weighing ↻ key is used to switch between net and gross indication.

When special function e.g. PCS is turned on, using ↻ key enables to go back to standard weighing mode.

Sign „0” on the left side signals that special function is turned on and user can go back to function mode by pressing ↻ key.

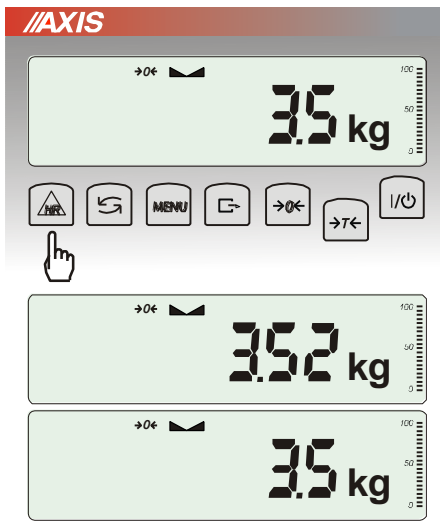

*HR* key working method:

During normal weighing temporary (5s) readout resolution increase is possible.

Return to normal indication is made automatically.

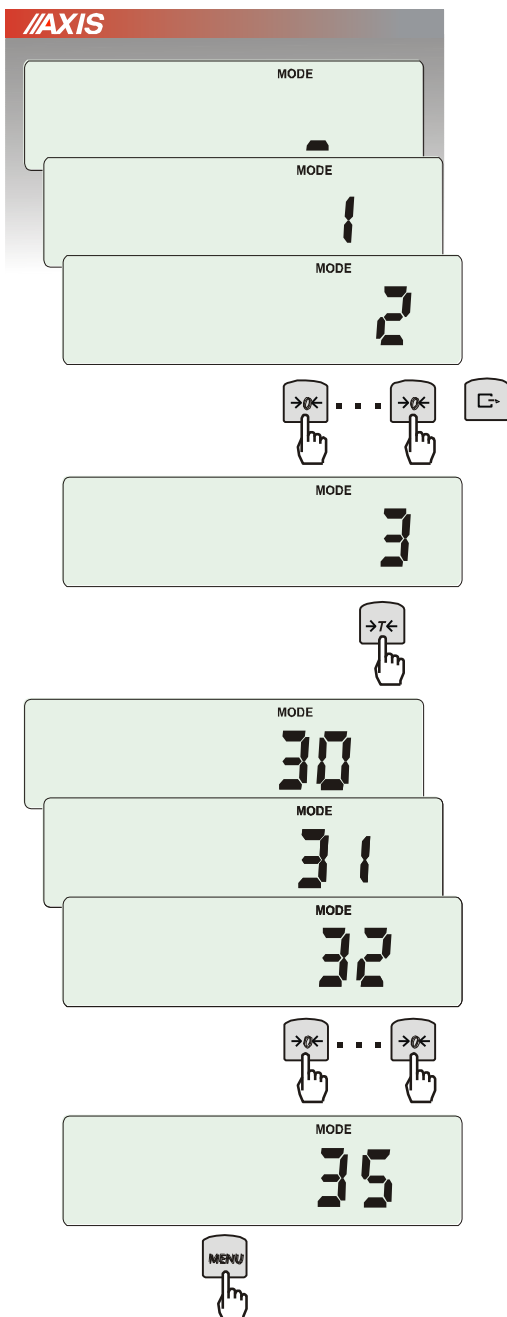

*Inscribing numerical values:*

Inscribing numerical values is needed in some special functions e.g. *tArE* function requires to inscribe tare values.

Keys:

→0← - increasing digit value,

□ - decimal point,

→T← - next digit position,

*MENU* - end of inscribing.

Menu diagram:

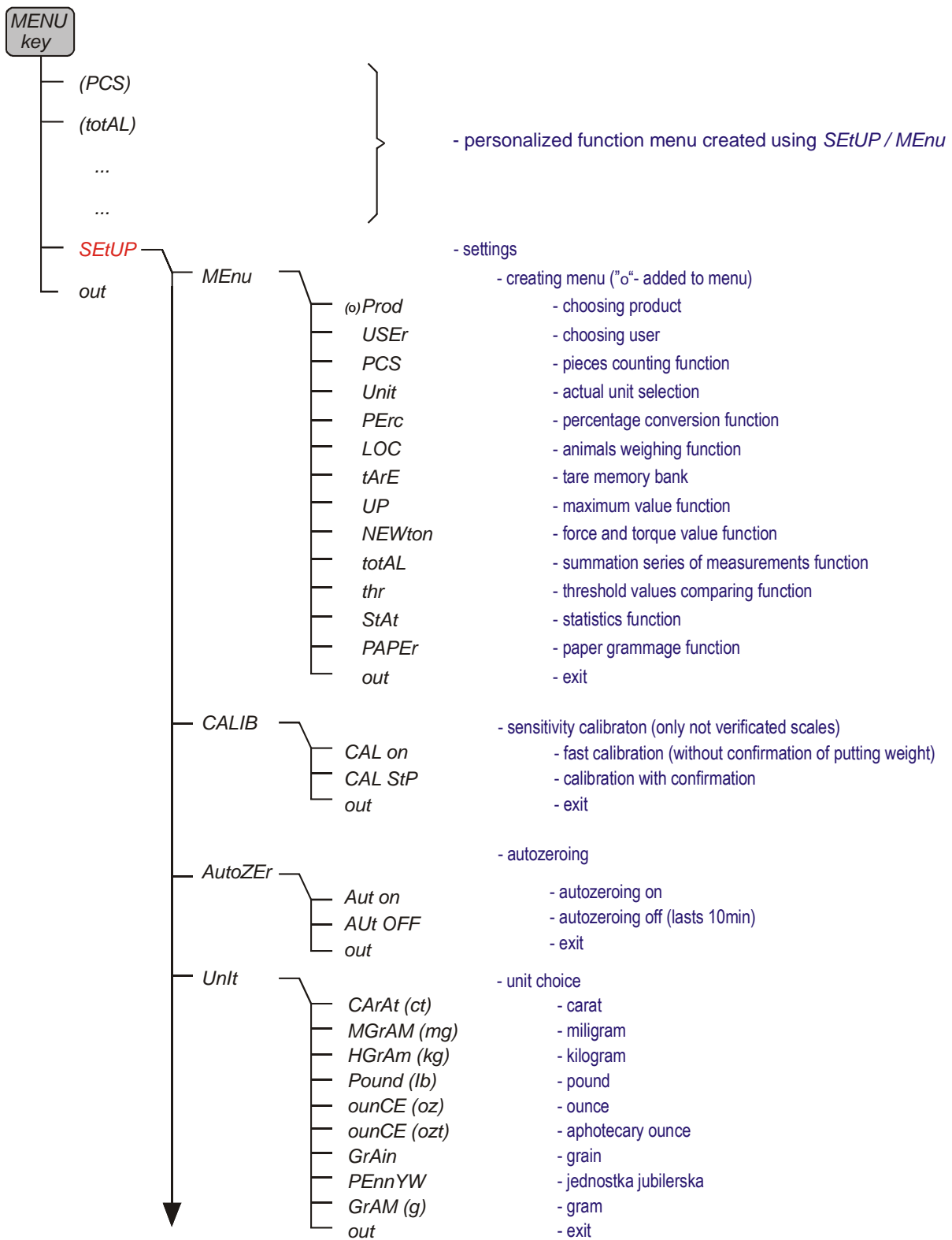

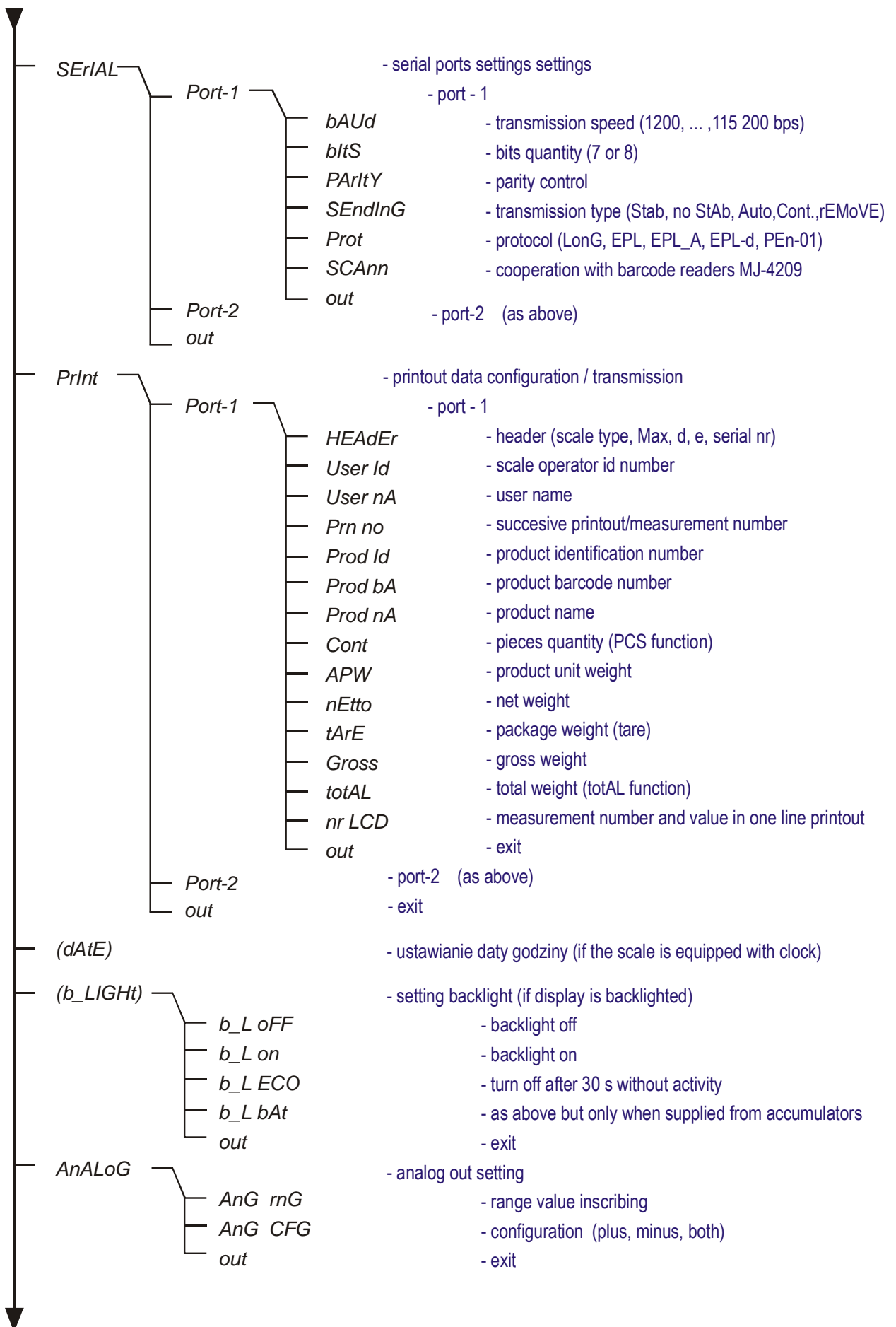



---

▼		
—	<i>(bAttEry)</i>	- turn on/off accumulator charging (if the scale is equipped with accumulator)
—	<i>(AUto OFF)</i>	- automatic turning off - saving accumulator power (as above)
—	<i>(ZEro)</i>	- scale start zero inscribing (factory zero)
—	<i>dEFAULT</i>	- restore default settings for all options
—	<b>SERVICE</b>	- options only for service
—	<i>out</i>	- exit

## 17. Scale setup (SEtUP)

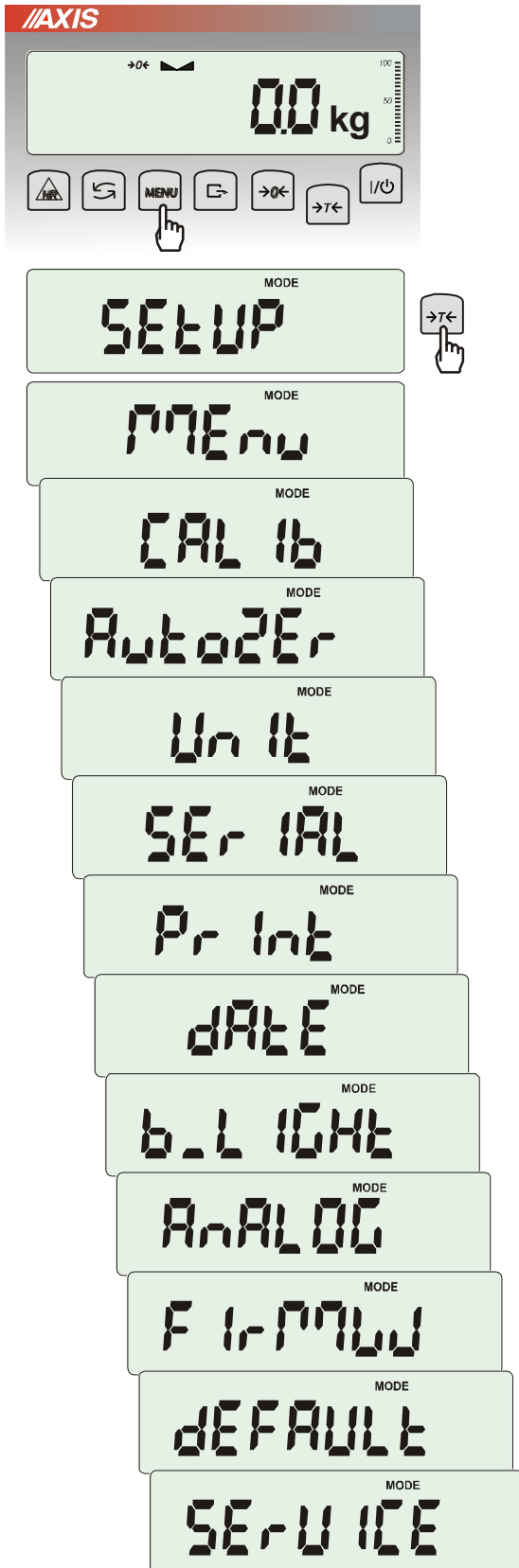

*SEtUP* contains all options used for setting scale work mode:

- ❑ *MEnu* – creating personalized user menu
- ❑ *CAL Ib* – scale sensitivity calibration
- ❑ *AutoZEro(ing)* – self-maintaining zero indication (unloaded scale)
- ❑ *UnIt* – weight unit selection
- ❑ *SErIAL* – setting serial ports
- ❑ *PrInt* – transmission (printout) data selection
- ❑ *FILTEr* – anti-disturbance filter
- ❑ *b\_LIGHT* – backlight setting
- ❑ *Ad420* – analogue out configuration
- ❑ *FirmW(are)* – updating software (only for service)
- ❑ *dEFAULT* – reset to factory settings (sample of using in chapter 15)
- ❑ *SErVICE* – service menu (only for service)

### 17.1 Scale calibration (CALib)

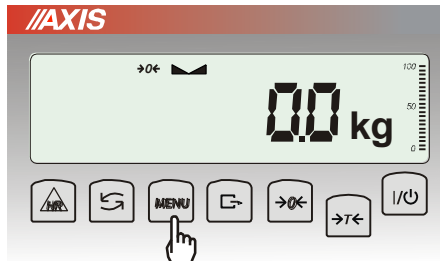

Press *MENU* key.



Press  $\rightarrow T \leftarrow$  key when *CALib* function appears.



The following options will be displayed:

- CAL on* – calibration with external recommended standard of mass (see technical data).
- CAL StP* – calibration with external weight, confirmation of successive steps - *MENU* key,
- out* – leave without changes



Press  $\rightarrow T \leftarrow$  key when *CAL StP* option appears (calibration in two steps).

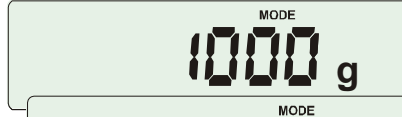
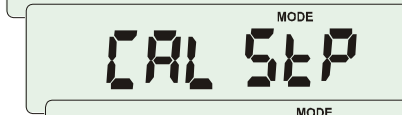

Press  $\rightarrow T \leftarrow$  key when weight value used for calibration is indicating or use *othEr* option and inscribe proper value ( keys  $\rightarrow 0 \leftarrow$ ,  $\leftarrow$ ,  $\rightarrow T \leftarrow$  )

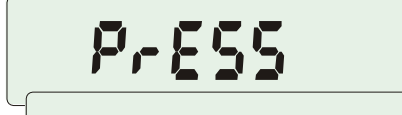
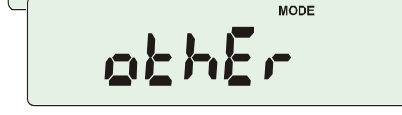

Press *MENU* and wait for writing zero to the scale.

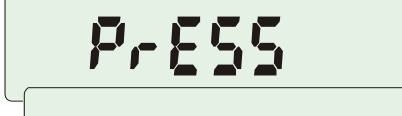
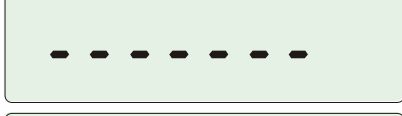

When *LOAD* message appears put standard of mass on the pan. Press *MENU* key (*CAL on* doesn't need pressing *MENU* key).

Wait until internal calibration is finished and zero indication is displayed.

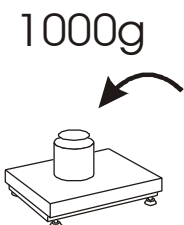
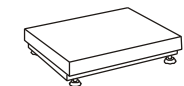
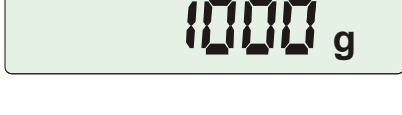

## 17.2 Autozeroing function (AutoZER)

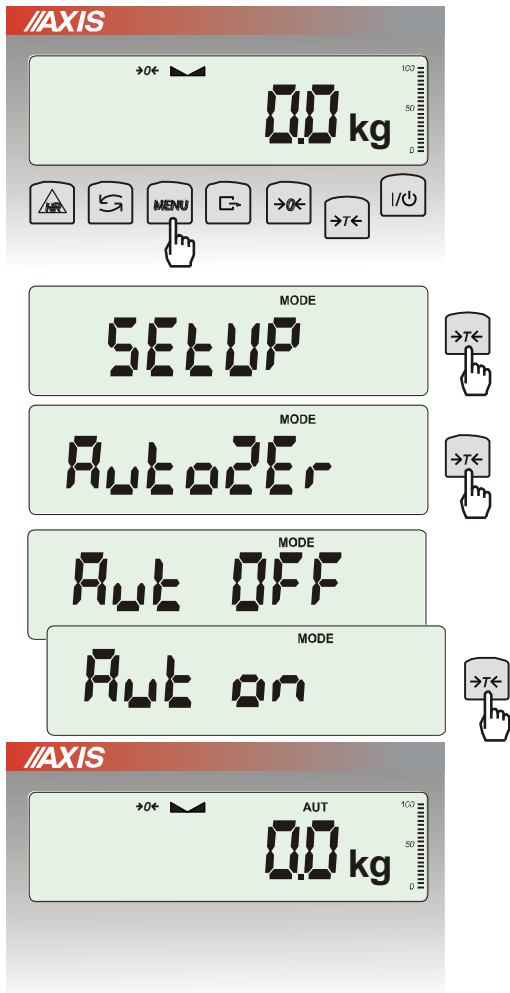

When the function is activated, the scale automatically ensures stable zero indication if the pan is empty or if zero indication was acquired by pressing  $\rightarrow T \leftarrow$  key.

To turn on the function use *MENU* key and using  $\rightarrow T \leftarrow$  key choose *AutoZER* and then *Aut on*. To leave the function press *MENU* key, then with  $\rightarrow T \leftarrow$  key chose *AutoZER* and *Aut OFF*.

Note:

1. *Aut* sign occurs only in scales with LCD display.
2. In scales with  $\rightarrow 0 \leftarrow$  key active function changes name into *AutoZE* (autozeroing) and works only when the scales is unbiased.

### 17.3 Weight unit selection (Unit)

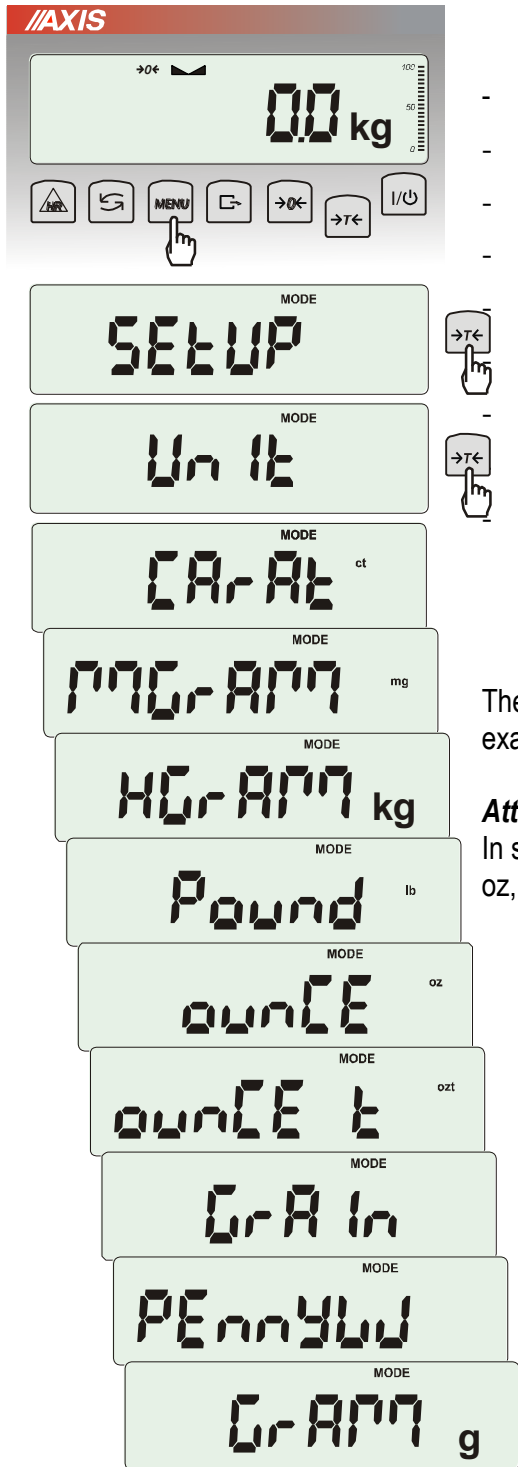

The function allows selecting weighing unit:

- CarAt (1 ct= 0,2 g) - carat,
- MGrAM (1mg=0,001g) milligram,
- KGrAM (1kg=1000g) kilogram,
- Pound (1 lb=453,592374g) English pound,
- OunCE (1oz=28,349523g) - ounce,
- OunCEt(1ozt=31,1034763g) pharmaceutical ounce,
- GrAln (1gr=0,06479891g) - grain
- PennYW (1dwt=1,55517384g) jewellery mass unit,
- GrAM (1g) - gram.

The way of choosing carats as weighing unit is shown on the example.



**Attention:**

In scale with LED display designations of mass units: lb, kg, oz, ozt, ct are not displayed. Units are pointed by diode light.

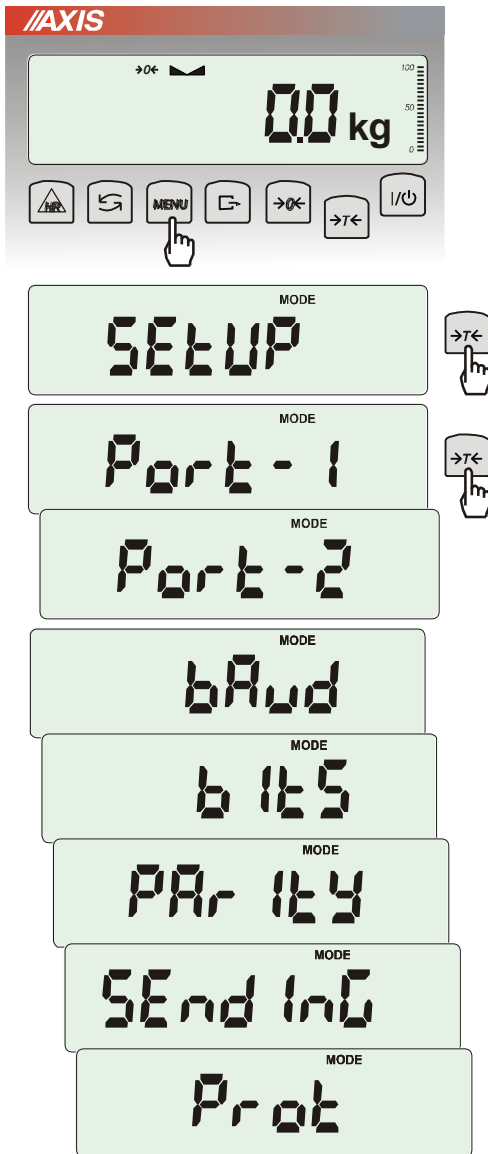
## 17.4 Serial port parameters setting (SERIAL)



The function allows setting independently communication parameters of both of serial ports *Port-1* and *Port-2* (executed in RS232C, RS485, USB or LAN standard):

- transfer protocol (*Prot*):
    - Long* – cooperation with printer or computer,
    - EPL* – cooperation with label printer in normal mode (activates *LABEL* function),
    - EPL\_A* – cooperation with label printer in automatic mode (activates *LABEL* function),
    - EPL\_d* – cooperation with special label printers,
    - Pen-01* – cooperation with PEN-01,
    - SCAnn* – cooperation with MJ-4209 barcode readers.
  - baud rate (*bAud*): (4800, 9600, ....115 200bps),
  - number of bits in single char. (*bitS*): 7, 8,
  - parity control (*PARtY*):
    - nonE* – no control
    - Odd* – nonparity
    - Even* – parity control,
  - scale number in network (*nr*):
    - (if the scale doesn't work in network the number must be 0),
  - transmission through serial interface (*SEndInG*):
    - StAb* – transmission after  key is used and result is stable,
    - noStAb* – transmission after  key is pressed without need of stabilisation,
    - Auto* - automatic transmission after load is put on and result is stable (*Auto*),
    - Cont* - continuous transmission, about 10 results per second (*Cont.*),
    - Remove* - trans
- Default parameter values:  
*Long*, 9600 bps, 8 bits, *none*, *StAb*

In order to set needed parameters choose *SERIAL* function, select appropriate parameter and press  $\rightarrow T \leftarrow$  key when required option or parameter value is displayed.

In scales with an additional serial port appear *Port-1* and *Port-2*, for the independent setting of both ports.

## 17.5 Printout configuration (Print)

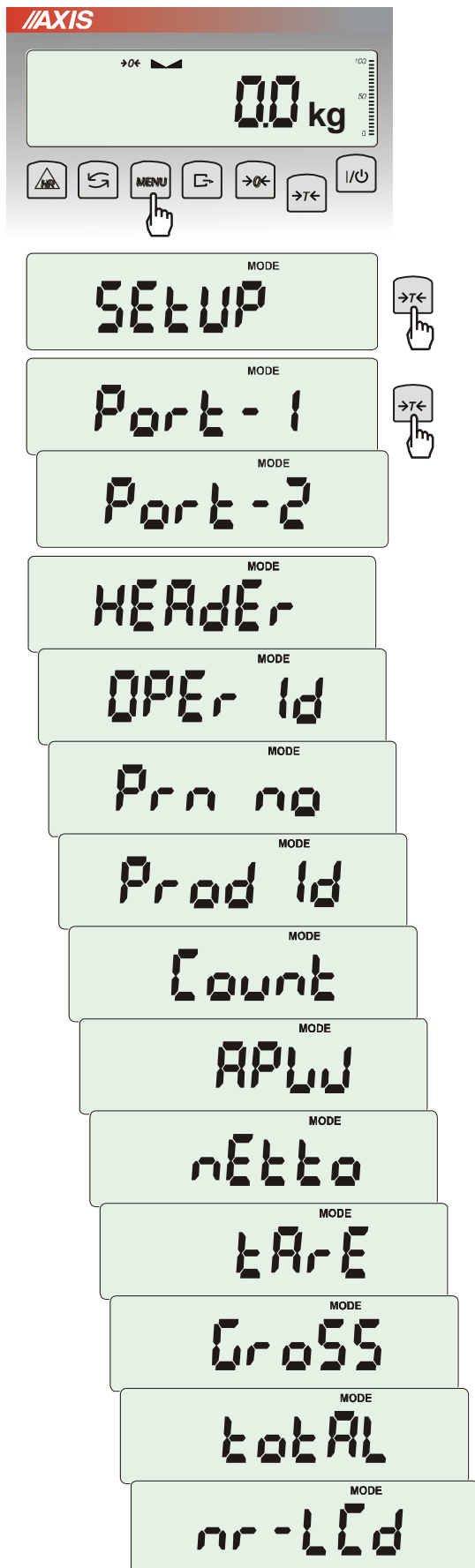

Function is used for printing additional information stored in scale memory, weighed product identification data and scale operator id. That information is inscribed using scale keys or scanner.

The function allows to switch on/off following positions on the printout:

- *HEAdEr* – header: name, model and scale number,
- *USER Id* – scale user identification number,
- *USER nA* – user name,
- *Prn no* – successive printout number (choose this option to zero counter),
- *Prod Id* – product number,
- *Prod bA* – product barcode (inscribed or scanned),
- *Prod nA* – product name,
- *Count* – counting result (PCS function),
- *APW* – unitary mass (PCS function),
- *netto* – net mass
- *tArE* – current tare value,
- *GroSS* – gross mass,
- *totAL* – total mass (*totAL* function)

### Attention:

If *Prod Id* or *USER Id* is chosen, it is possible to inscribe quickly their new values (with omission of main menu).

In order to do that hold (about 3 seconds) *MENU* key and release it when *Prod Id* or *USER Id* indicates. Inscribe new value using keys:

- 0← - increasing digit,
- - decimal point,
- T← - next digit,
- MENU* - end.

While inscribing *Prod id* user can use barcode reader connected to RS232C interface.

If the scale is equipped with two serial joints *Print* function is set independently for both interfaces.

**Sample printout during normal weighing (all printout positions deactivated):**

```
20.07 kg
20.04 kg
20.04 kg
```

**Sample printout during normal weighing with clock option (all printout positions deactivated):**

```
20.07 kg 2012-11-08 10:01
20.04 kg 2012-11-08 10:01
20.04 kg 2012-11-08 10:01
```

**Sample printout during normal weighing ( some printout positions activated):**

```
BA30
MAX: 30kg e=d=0.01kg
S/N  :

ID OPER.      : 000001
DATE          : 2012-11-08
TIME          : 12:26
NO            :      3
ID PROD.      : 01
COUNT        : 0 PCS
APW           : 0.000 g
NET           : 3.08 kg
TARE          : 0.00 kg
GROSS         : 3.08 kg
TOTAL         : 0.00 kg
```



## 17.6 Setting backlight function (*b\_LIGHT*)

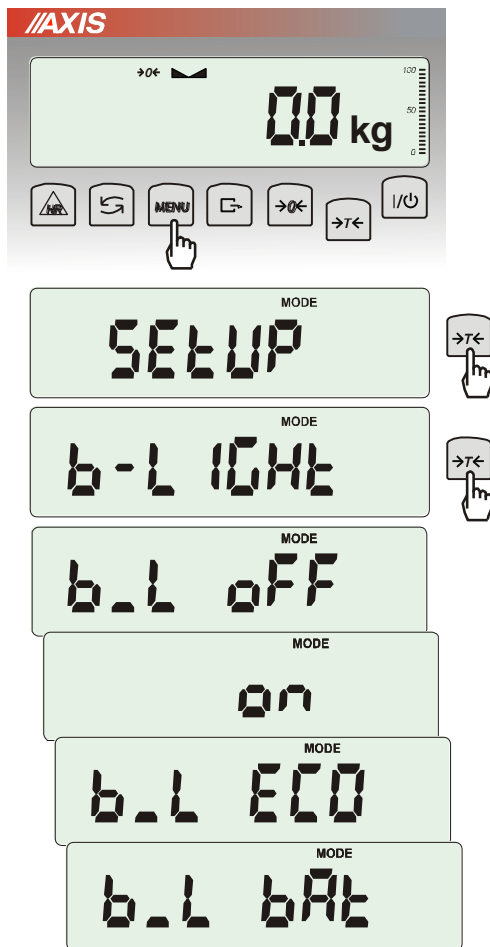

The function is used for choosing the work mode of scale display backlight:

- *b\_L OFF* – switch backlight off,
- *b\_L on* – switch backlight permanently on,
- *b\_L ECO* – switch off after 30 seconds of inactivity (no load changes and no key operation),
- *b\_L bAt* – like above, but when powering from accumulators only,
- *out* – out without changes.

Switching backlight off causes decrease of energy consumption by the scale, what is important during powering from accumulators.

## 17.7 Analog out configuration (AnALoG)

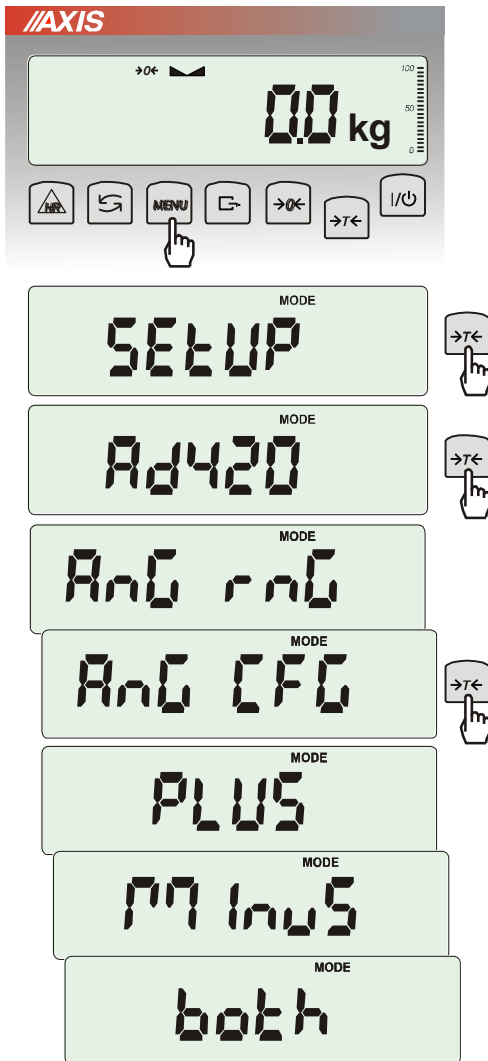

This option enables to set-up analog out (4-20mA or 0-10V) working method used e.g. in PLC regulators:

- *AnG r nG* – inscribing Max value
- *AnG CFG* – working mode configuration (*PLUS* – workmode for only positive values, *MinuS* – only for negative values, *both* – for both)

## 17.8 Entering reference zero value (ZErO)

**Note:** This function is enabled in non-legalized scales only.

ZErO function allows entering new value of reference zero (value referred to empty pan) without need of contacting with authorised service centre.

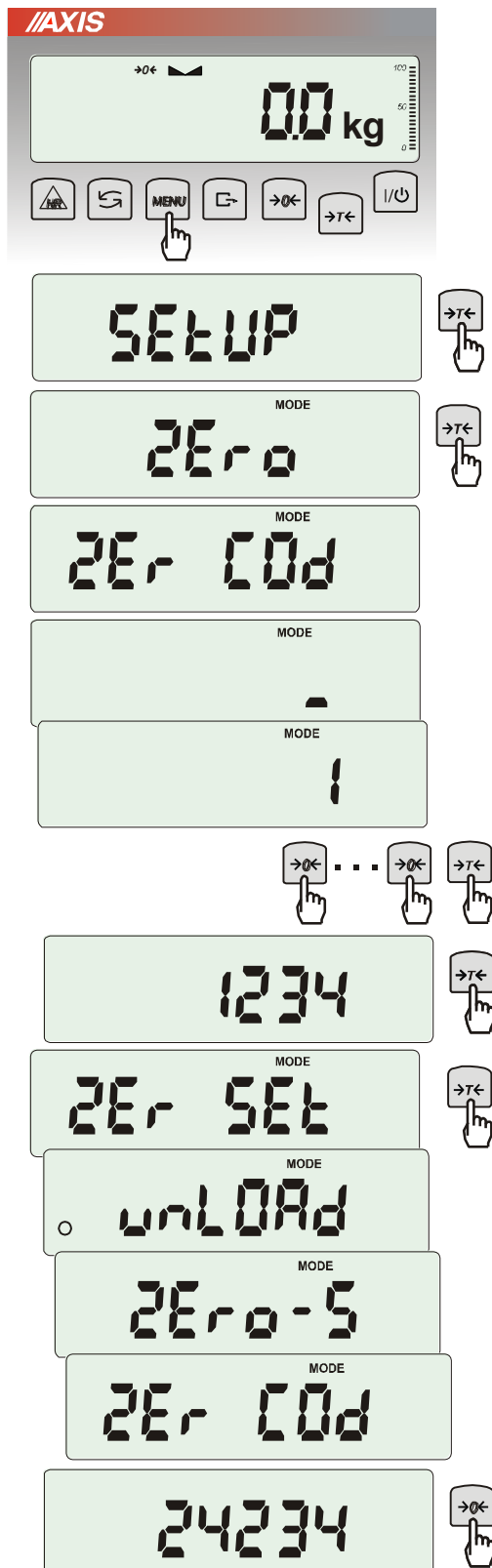

Press *MENU* key.

When *ZErO* is displayed press  $\rightarrow T \leftarrow$  key.

On the display a sign *ZEr Cod* will show up momentary and the a dash on last digit position.

To enter code ( in new scale: 1234) use keys:

$\rightarrow 0 \leftarrow$  - increasing digit,

$\rightarrow T \leftarrow$  - next digit,

*MENU* – end of inscribing.

The following options appear successively on display:

*ZEr Cod* – enter new secure code value,

*ZEr SET* – enter new zero value

Using  $\rightarrow T \leftarrow$  key, choose *ZEr SET*. Direct result from A/C converter will appear on scale display.

When the pan is empty press  $\rightarrow 0 \leftarrow$  key.

Wait for finishing zeroing process.

In order to change access code use *ZEr Cod* option (as mentioned earlier).

## 18. Special functions description

All scales besides basic metrological functions: weighing and taring, have a set of special functions. Depending on meter type functions set differs. Below a list of functions available in standard ME-01 type meters:

- ❑ Products data base (*Prod*),
- ❑ Users data base (*USEr*),
- ❑ pieces counting function (*PCS*),
- ❑ change of mass unit (*UnIt*),
- ❑ percentage weighing function (*PErC*),
- ❑ selecting label number function (*LABEL*),
- ❑ weighing large animals function (*LOC*),
- ❑ entering tare function (*tArE*),
- ❑ maximum value indication function (*UP*)
- ❑ force measuring function (*nEWton*)
- ❑ statistical calculations (*StAt*)
- ❑ paperweight calculation function (*PAPEr*)

and functions that require additional equipment to be completely functional:

- option with accumulator supply:
  - Setting accumulators charging (*bAttErY*)
  - Automatic switching off scale function (*AutoOFF*)
- options with the clock:
  - setting current date and time function (*dAtE*)
  - total weight function (*totAL*)
- options with the transoptors connectors (*WY $\Gamma$* ):
  - checkweighing function (*thr*)
- option with radio connection:
  - function of choosing communication channel (*rF Chn*)

LabEL function is available in scales with EPL or EPL-A transmission protocol activates (go to *SetuP/SERIAL*).

In scales with LED display special functions don't have additional marks on display and names of some functions are shortened.

## 18.1 Products and users database (Prod i USEr)

Scale is equipped with products and users database with capacity up to 300 products and 10 users.

Database consists of:

- *M nr* – memory number where data is saved,
- *Prod Id* - product identification number,
- *Prod bA* – product barcode,
- *Prod nA* – product name,
- *USEr Id* – user identification number,
- *USEr nA* – user name,
- *APW* - unitary weight (used when pieces counting),
- *PtArE* - inscribing permanent tare to the product,
- *thr Lo* - threshold value (low),
- *thr Hi* - threshold value (upper).

Database can be built in Excel datasheet form, where each product has one row and each column have product data. This way created database, saved in \*.csv extension with semicolons can be send to scale using *Scale Database* software and scale's serial interface. *Scale Database* is available on our webpage [www.axis.pl/en](http://www.axis.pl/en).

Database and possibility to cooperate with external devices: printer, label printer, barcode reader and computer enables to built product identification and product archiving systems.

Product barcode readout (during scale working) initiates searching through database and in case of finding proper record, recalls product data (*Found* communicate). Barcode reader enables also to insert numerical data conveniently (standard ME-01 meter doesn't have numerical keys). Using alphanumeric code (for example 128 code) it can be also used to insert names of products and users.

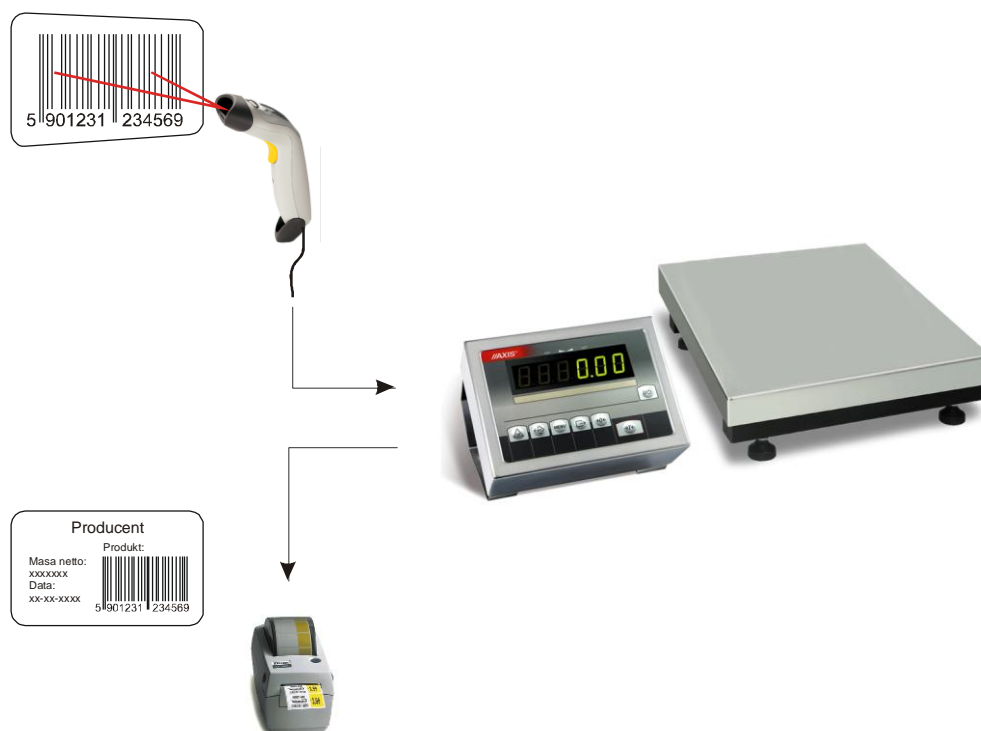

### Inscribing data to base

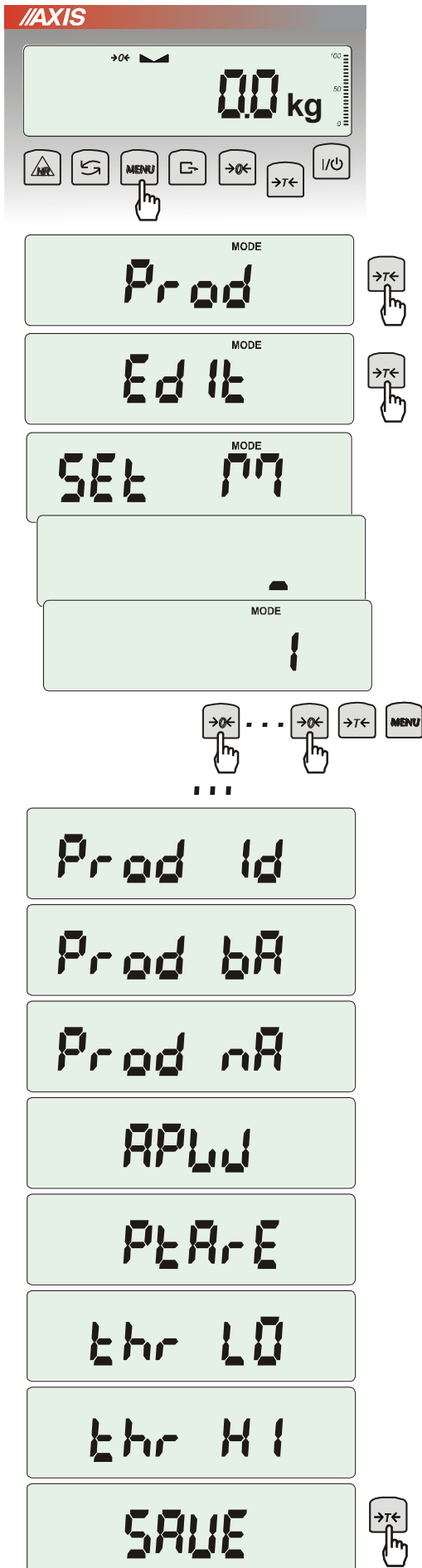

*Prod* and *USER* options enables adding and deleting product and user data.

For products database available options are:

- *EdIt* –
- *Add* – add product to database,
- *dEL OnE* – deleting single element from database
- *dEL ALL* – deleting all elements from database
- *dAtAb* – changing working mode with database (default mode *Stb*):
  - *Stb* – searching products in database and working with products outside the base; if product is found then *Found* communicate appears and all product data is recalled; if there is no product in database then no communicate appears, the scale stores id/barcode number temporarily in memory and enables to send it to the port (to printer/computer) together with actual weighing result.
  - *LIMit* – searching through products from database; if product is found then *Found* communicate appears and all product data is recalled; if there is no product in database then *not Found* communicate appears.
- *Prn\_P* – sending all products database to port.

To inscribe data use *EdIt* option and keys:

→0← - increasing digit,

→T← - next digit,

MENU – end of inscribing.

Barcode reader (connected to RS232C interface) can also be used to inscribe data and this way it is faster and more effective.

Each database product has following data:

- *M Id* – memory cell number in products database,
- *Prod Id* – product identification number,
- *Prod bA* – product barcode,
- *Prod nA* – product name (inscribed from PC or barcode reader),
- *APW* – product unitary weight (optional),
- *PtArE* – product package weight (optional),
- *thr LO* – lower threshold (MIN value),
- *thr HI* – upper threshold (MAX value).

Saving inscribed product data is done by using *SAVE* option.

Users database is edited by similar function named *USEr* and consists of several options:

- *USEr Id* – user identification number,
- *USEr nA* – user name (inscribed from PC or scanner),
- *Pm\_U* – sending users database to port.

Saving data is also done by *SAVE* option.

### Recalling from database

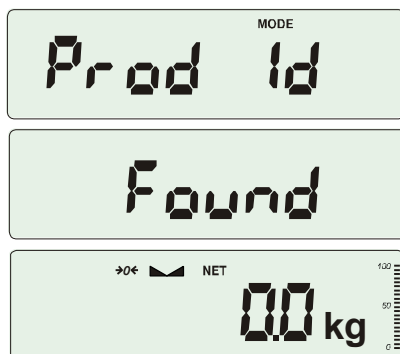

The fastest way to recall product from database is to readout his barcode number (*Prod bA*) by using barcode reader (option). It can be done in any moment.

After readout of proper barcode scale indicates one of communicates:

- *SCAn* – barcode from outside the base accepted (*Std* mode),
- *not Found* – barcode from outside the base not accepted (*LIMIt* mode),
- *Found* – product barcode found in database and data recalled.

**Attention:** If the scale doesn't indicate any communicate, check barcode reader connections, port configuration and transmission protocol (*SErIAL* function).

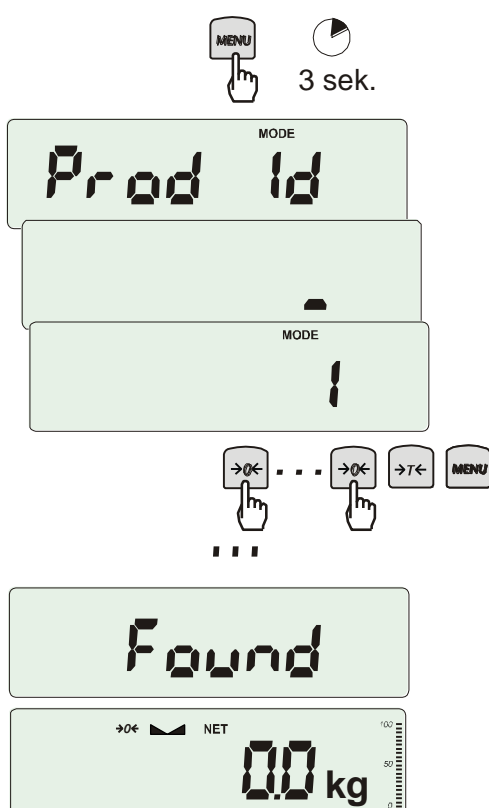

Other fast way is to press and hold *MENU* key. *Prod Id* communicate indicates and after a few seconds user can inscribe identification number. If the number is already saved in base *Found* communicate appears and all the product data is recalled.

To edit data choose *EdIt* option and use following keys:

- 0← - increasing digit,
- T← - next dixit,
- MENU – end of inscribing.

Product recalling is also possible by using *Prod* and *Prod Id* options (previous site).

***Weighing results and data transmission from scale to computer or to printer***

To each weighing results transmission a set of product and user identification data is added. The set is activated in *Print* option (17.5 chapter).

Available data from products and users base (*Print / SEtuP* option):

- *USEr Id* – user identification number,
- *USEr nA* – user name (inscribed from PC or scanner).
- *Prod Id* – product identification number,
- *Prod bA* – product barcode (inscribed or scan),
- *Prod nA* – product name (inscribed from PC or scan).



## 18.2 Pieces counting function (PCS)

The diagram illustrates the PCS function steps:

- Scale display: 0.0 kg
- Scale display: 1.3 kg (with 5 pieces on the pan)
- Press **MENU** key
- Mode screen: **PCS**
- Press **T** key
- Mode screen: **PCS OFF**
- Press **T** key
- Mode screen: **PCS on**
- Press **T** key
- Mode screen: **PCS ..**
- Press **T** key
- Mode screen: **PCS 5**
- Press **T** key
- Mode screen: **PCS 500**
- Press **T** key
- Mode screen: **PCS SET**
- Press **T** key
- Mode screen: **PC APW**
- Press **T** key
- Mode screen: **PCS r5**
- Scale display: 5 pcs
- Scale display: 15 pcs (with 10 pieces added)

This function enables to count identical pieces, e.g. turnbuckles or buttons.

A measurement is performed in two phases:

- first phase - single piece weight calculation on the basis of defined pieces amount (5, 10, 20, 50, 100, 200 or 500 pieces),
- second phase – pieces counting.

First phase options:

- **PCS ..** – recalling of a value inserted earlier (this quantity must be inscribed earlier),
- **PCS SET** – set any amount of pieces in a sample,
- **PCS APW** – set unitary mass directly,
- **PCS rS** – inserting number of details in a sample and receiving of their mass from other scale connected by RS-232C.

It is advised that single piece weight is not less than one reading unit and sample weight used in first phase is bigger than 100 reading units.

To leave function press **MENU** key and then using **→T←** key chose **PCS** and **PCS OFF**.

**Note:**

1. *APW too LOW* communicate signalises that a sample was not put on the pan or if single piece weight is less than one-tenth readout plot (counting is not possible).
2. *APW LOW* communicate signalizes that single piece weight is more than one-tenth but less than one readout plot. (counting possible but with bigger errors, result blinks).
3. In scales equipped with LED display pcs sign is replaced with “■”.

### 18.3 Percentage weighing function (PErC)

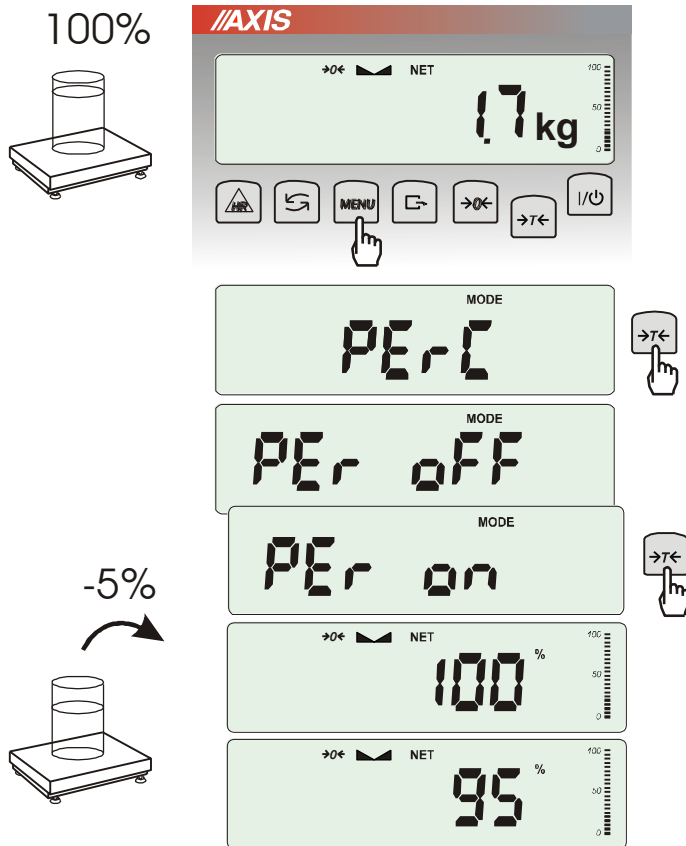

This function allows displaying weighing result in percents.

A measurement is performed in two phases:

- first phase – weighing a reference sample (100%),
- second phase – measuring specific sample as a percentage of the reference sample.

Weighing result is displayed in different format, depending on the weight value of reference sample.

The function has the following options:

- *PEr OFF* – disable the function,
- *PEr on* – set current scale indication as 100% and activate percentage weighing,
- *out* – exit without changing settings.

**Note:**

1. *PEr Err* message informs that reference 100% mass is less than  $0,5 \cdot \text{Min}$  or was not defined.
2. In scales with LCD display sign "■" is replaced with %.

## 18.4 Label choosing function (LAbEL)

This function is used in scale with *EPL* (*SErIAL* function) data protocol. This protocol enables label printout with actual scale indication and chosen data from *PrInt* special function (variable data), for example date and time. Other data, for example company address, product name, barcode can appear on label as a constant text. Label patterns with number (4 digit) used by user should be saved in scale memory according to printer manual. Label pattern choice is made by inscribing label number using *LAbEL* function.

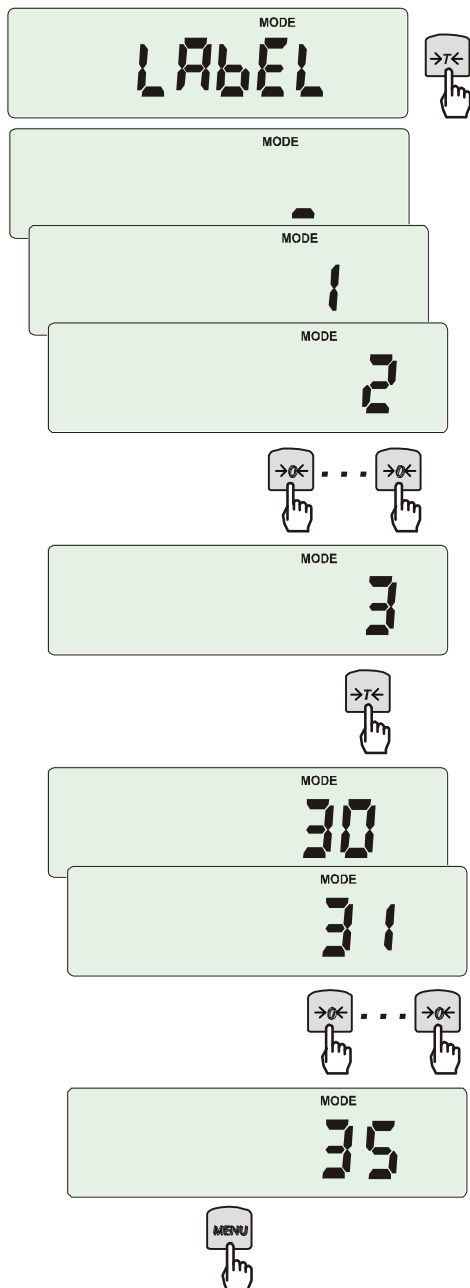

Press *MENU* button.

When *LAbEL* is displayed press  $\rightarrow T \leftarrow$  key.

Actual label number will show.

To enter new label number press  $\rightarrow T \leftarrow$  key, to exit function without number change press *MENU*.

To inscribe label number use keys:

$\rightarrow 0 \leftarrow$  - digit increase,

$\rightarrow T \leftarrow$  - next digit,

*MENU* - end.

After entering label number, putting load and pressing  $\rightarrow \leftarrow$  key will cause sending data to label printer.

Data format sent to label printer (label nr 1, language EPL-2):

US	(55 53 0D 0A)
FR"0001"	(46 52 22 30 30 30 31 22 0D 0A)
?	(3F 0D 0A)
00:00	(30 30 3A 30 30 0D 0A)
2000.00.00	(32 30 30 30 2E 30 30 2E 30 30 0D 0A)
10 g	(20 20 20 20 20 31 30 20 20 67 0D 0A)
P1	(50 31 0D 0A)

## 18.5 Weighing animals function (LOC)

The function allows weighing animal moving on the scale.

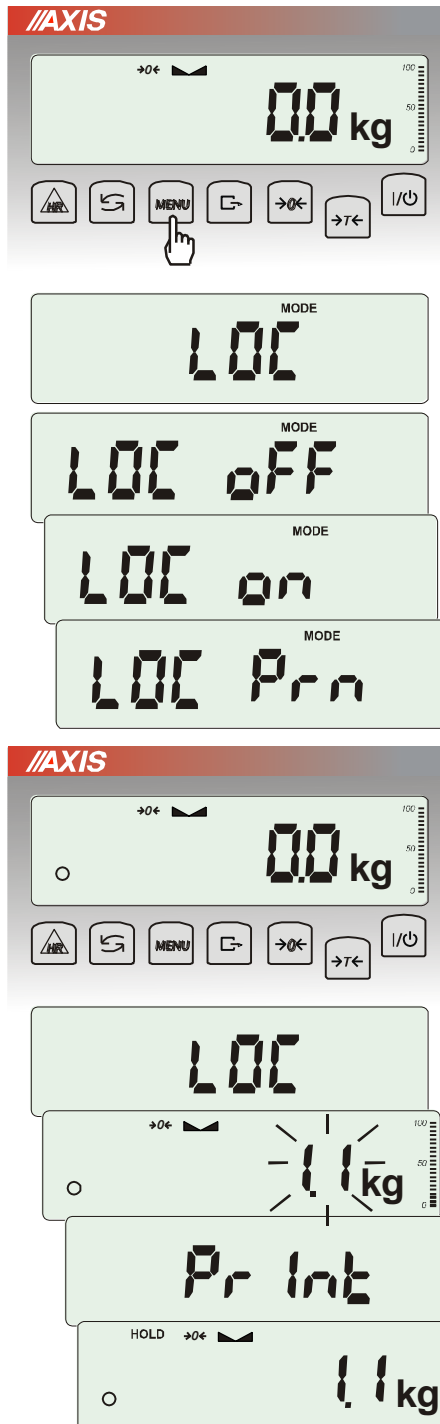

Press *MENU* key.

When *LOC* function is displayed press  $\rightarrow T \leftarrow$  key. The following options appear on display successively:

- *LOC off* – leave the function,
- *LOC on* – automatic weighing after loading the scale,
- *LOC Prn* – the measurement initiated manually by pressing  $\rightarrow T \leftarrow$  key.

When *LOC on* is displayed press  $\rightarrow T \leftarrow$  key.

Tare the scale using  $\rightarrow T \leftarrow$  key if necessary and place the animal on the pan.

Wait until the weighing result is averaged – scale display blinks. Then scale will show stable (averaged) result and will send it through serial port.

The result remains on display for about 30 second.



### Important notes:

1. The loads lower than *Min* value are not averaged.
2. In case when putting animal on scale takes more than 5s it is suggested to choose *LOC PRN* option (measurement started manually by pressing  $\rightarrow T \leftarrow$  key).

## 18.6 Constant tare memory function (tArE)

This function enables to measure gross weight of a sample placed in a container of a known weight value (stored in the memory) and to display calculated net weight of the sample. Tare value is recalled from the memory with  $\rightarrow 0 \leftarrow$  or  $\rightarrow T \leftarrow$  key when the pan is empty. Tare value may be entered using keypad or by putting container on the pan.

### Inscribing tare value to memory:

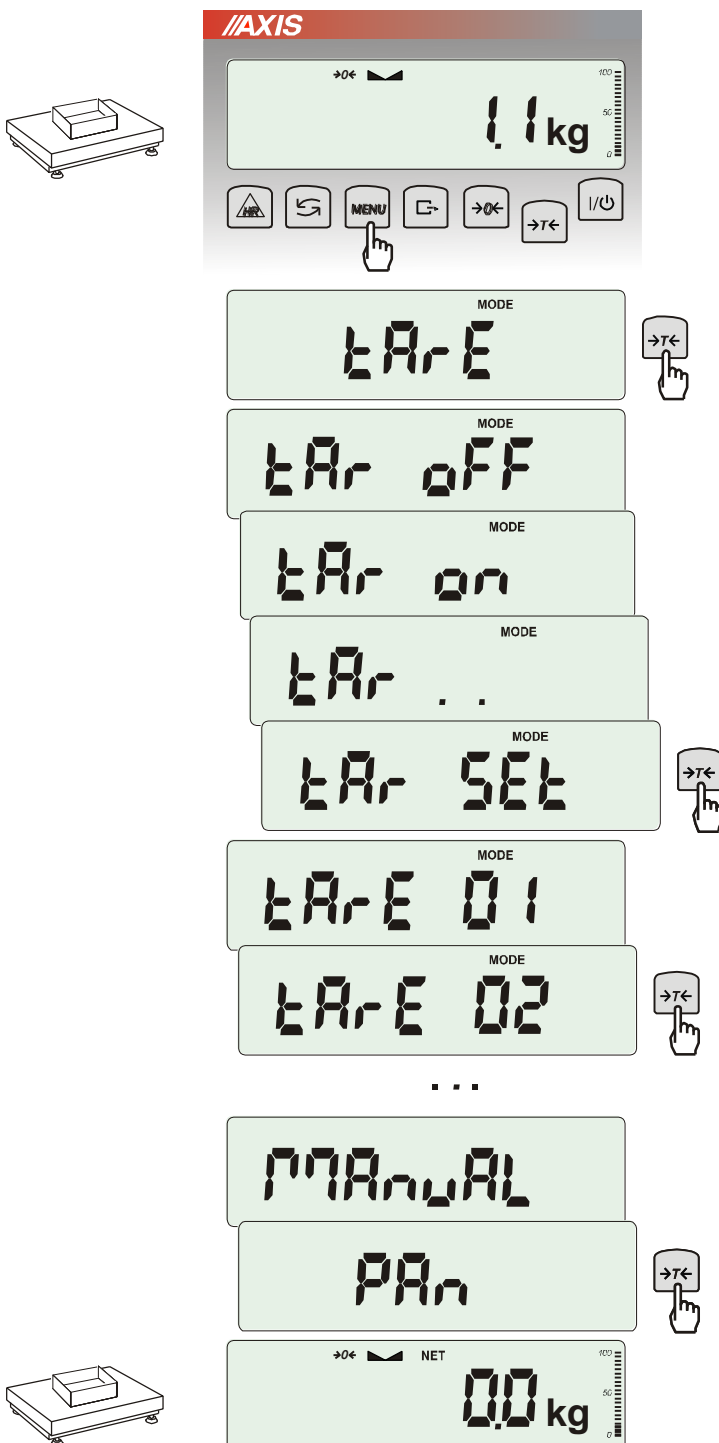

After pressing **MENU** key and choosing **tArE** function using  $\rightarrow T \leftarrow$  key, the following options are available:

- **tAr OFF** – leave the function,
- **tAr on** – activate the function with the previous tare value,
- **tAr ..** – sample tare value from the pan,
- **tAr SET** – enter tare value with keys:  $\rightarrow 0 \leftarrow$ ,  $\rightarrow T \leftarrow$  and **MENU**
- **out** – printout a setting value of tare.

Press  $\rightarrow T \leftarrow$  key when **tAr SET** is displayed.

By pressing  $\rightarrow T \leftarrow$  key choose proper memory cell where tare will be stored: **tAr 01, 02, ... , 10**.

Choose inscribing method :

- **MANUAL** – inscribing using keys:  $\rightarrow 0 \leftarrow$ ,  $\rightarrow T \leftarrow$  and **MENU**,
- **Pan** – inscribing mass value that is on the pan.

After storing tare, the scale starts working with inscribed tare value.

**Note:**

Tare value is stored in memory also after unplugging the scale from the mains.

**Weighing with constant tare:**

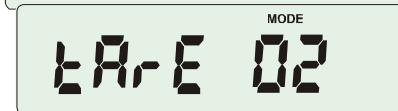
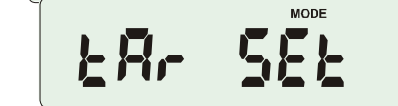
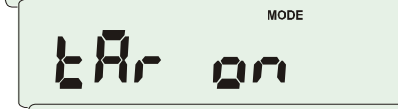
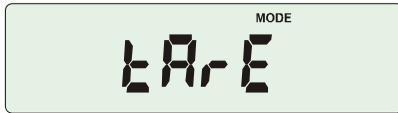
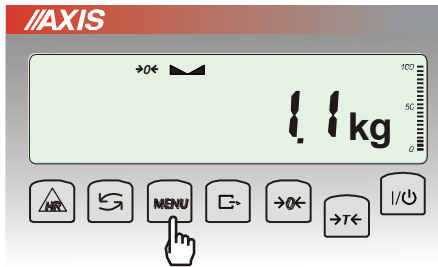
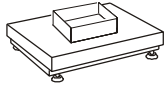

...

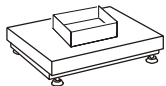
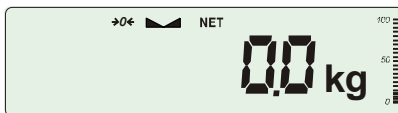

In order to use tare value that is located in memory, choose from menu *tArE* function and then *tAr on* option.

A list of memory cells will show up:

*tAr 01, 02, ... , 10.*

Cells with inscribed value are marked with "o" sign on the left side, active value marked with "▲".

**ATTENTION:** In scales with LED display, cells with inscribed value are marked with "■".

Choose proper memory cell using  $\rightarrow T \leftarrow$  key.

*tArE* function is activated with chosen tare value. Moreover the scale will indicate nett weight (weight on the pan minus tare values). Using  $\rightarrow T \leftarrow$  key (or  $\rightarrow 0 \leftarrow$ , while empty pan) causes scale zeroing and then subtraction of recalled tare. Minus indication will show up.

## 18.7 Maximum value indication function (UP)

This function allows holding maximum (or minimum) value that is indicating at the moment.

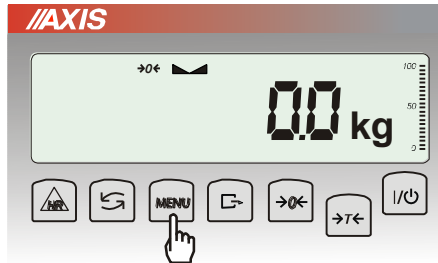

Before measurement scale should be tared.

Function has following options:

-UP OFF – function off,

-HIGH – holding maximum value,

-LOW – holding minimum value.

Pressing →T← key will cause result zeroing.

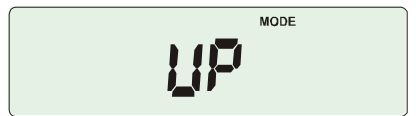

**Note:**

Autozeroing function and the stabilisation indicator are deactivated when UP function is running.

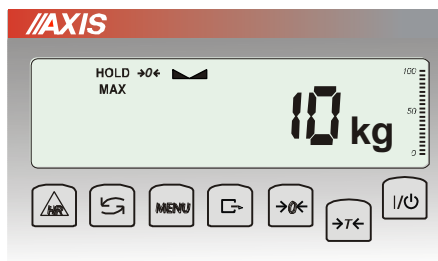
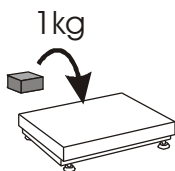
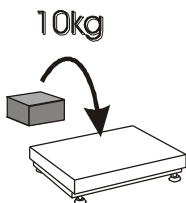
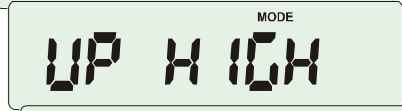

## 18.8 Force measuring function (nEWton)

Function activation causes displaying result in force units (N).

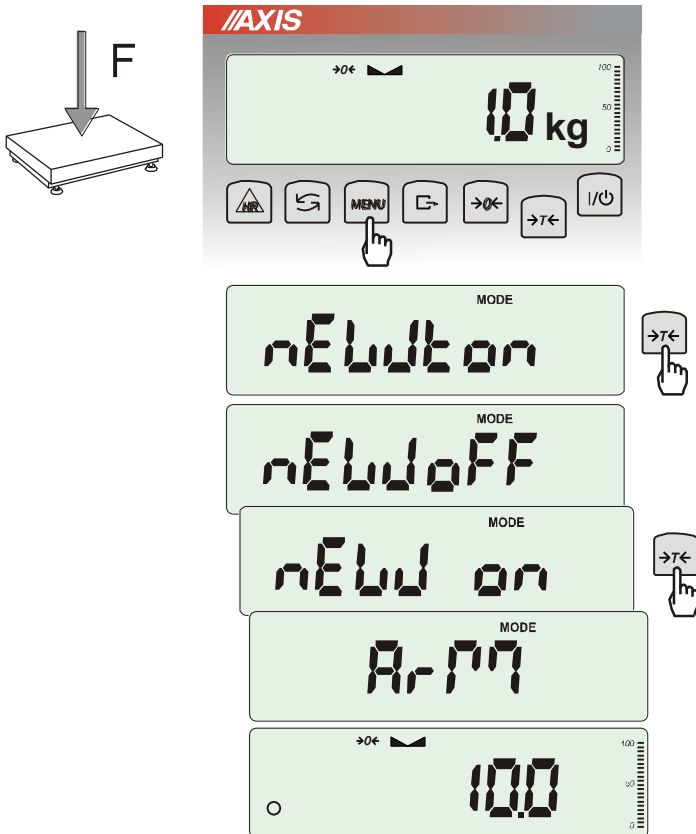

Press *MENU* key.

Using  $\rightarrow T \leftarrow$  key choose *NEWto* function.

Function has several options:

- *nEW off* – function off,
- *nEW on* – measurement in Newtons,
- *ArM* – torque measurement (arm length should be inscribed in meters using  $\rightarrow T \leftarrow$ ,  $\rightarrow 0 \leftarrow$  and *MENU* keys).

### **Attention:**

Units conversion from mass (kg) to force (N) is made for acceleration of gravity ( $g=9,80665\text{m/s}^2$ )

**Note:**  $1\text{N} \approx 0,1019\text{kg}$



## 18.9 Total weight function (totAL)

The function allows calculating total weight for series of measurements, which can be greater than scale capacity. It allows calculating total weight as well as average value.

Press *MENU* key.

When *totAL* is displayed press  $\rightarrow T \leftarrow$  key.

The following options will appear successively:

- *tot Prn* - report printout without clearing total register,
- *tot oFF* - clearing total register, report printout and leaving the function,
- *tot □* - working with receipt printout after each measurement,
- *tot -* - working without receipt printout,
- *tot CFG* – saving measurement mode (using  $\rightarrow \leftarrow$  key: *Manual*, after taking off the load : *auto*).

Press  $\rightarrow T \leftarrow$  key when *tot □* is displayed.

Perform measurement series by pressing  $\rightarrow \leftarrow$  key for storing results into total register.

In order to print and display results enter the function by choosing *totAL* and *tot Prn* option from menu.

The results are displayed in the following sequence:

- total weight (SUM  $\equiv$ ),
- number of registered measurements (n),
- average value ( $\equiv$ ),

regarding that moving to display successive result is performed after pressing  $\rightarrow \leftarrow$  key.

*Attention:* In scales with LED display SUM sign is replaced by “ $\equiv$ ”.

In order to go back to total weighing without zeroing total register press  $\rightarrow \leftarrow$  key several times.

The diagram illustrates the step-by-step process of navigating the 'totAL' function menu. It shows a series of 15 screenshots of the scale's display, with arrows indicating the sequence. A small diagram on the left shows a weight being placed on the scale and then removed. The sequence of screens is as follows:

- Initial state: 00 kg
- Press MENU key
- MODE: totAL
- MODE: tot Prn
- MODE: tot oFF
- MODE: tot □
- MODE: tot -
- MODE: tot CFG
- Press  $\rightarrow T \leftarrow$  key
- 10 kg
- 00 kg
- ...
- 00 kg
- MODE: totAL
- MODE: tot Prn
- MODE: TOTAL SUM 100 kg
- MODE: TOTAL n 10
- MODE: TOTAL = 10 kg

To leave the function with clearing total register, select *totAL* function from menu and choose *tot oFF* option. Scale prints the communicate informing about clearing registers.

The form of receipt after each measurement:

Date: ...	Time. ...
measurement no	weight
measurement no	weight

Report form:

Date: ...	Time. ...
TOTAL WEIGHT	=
NUMBER OF SAMPLES	=
AVERAGE VALUE	=

**Note:**

*When the scale doesn't have an internal clock, Date and Time do not appear on printout.*

*Maximum number of measurements is 99 999.*

*Maximum total load 99 999 000d.*

*The weighing unit of the total value from the register (Total) is the same as the weighing unit stated on the keypad or is 1000 times greater, what is signalled by "o" indicator at the left of the display.*

*If the registered value is too big to be displayed, "E" communicate appears on the display. If the number of series is too high and cannot be displayed, "Err1" communicate appears on the display*

## 18.10 Checkweighing function (*thr*)

This function allows comparing weighing result with two programmed reference values: lower and upper threshold. Comparison result is signalled with indicators (MIN, OK, MAX) and sound signal generated when threshold values are exceeded.

If comparison result is:

- smaller than zero threshold – no signal,
- smaller than lower threshold – the scale signals MIN (yellow colour),
- between threshold values - the scale signals OK (green colour, with the short sound signal),
- greater than upper threshold - the scale signals MAX (red colour, long sound signal).

The checkweighing results can be use to control:

- optical indicator (*Indication mode*),
- batching devices (*Batching mode*).

Standard scale is set for cooperation with optical indicator.

On outputs P1-P3 (*Relays socket*) short-circuit states appear as result of comparison scale indication with threshold values.

On the chart below output states are shown during increasing load on the scale for both working modes:

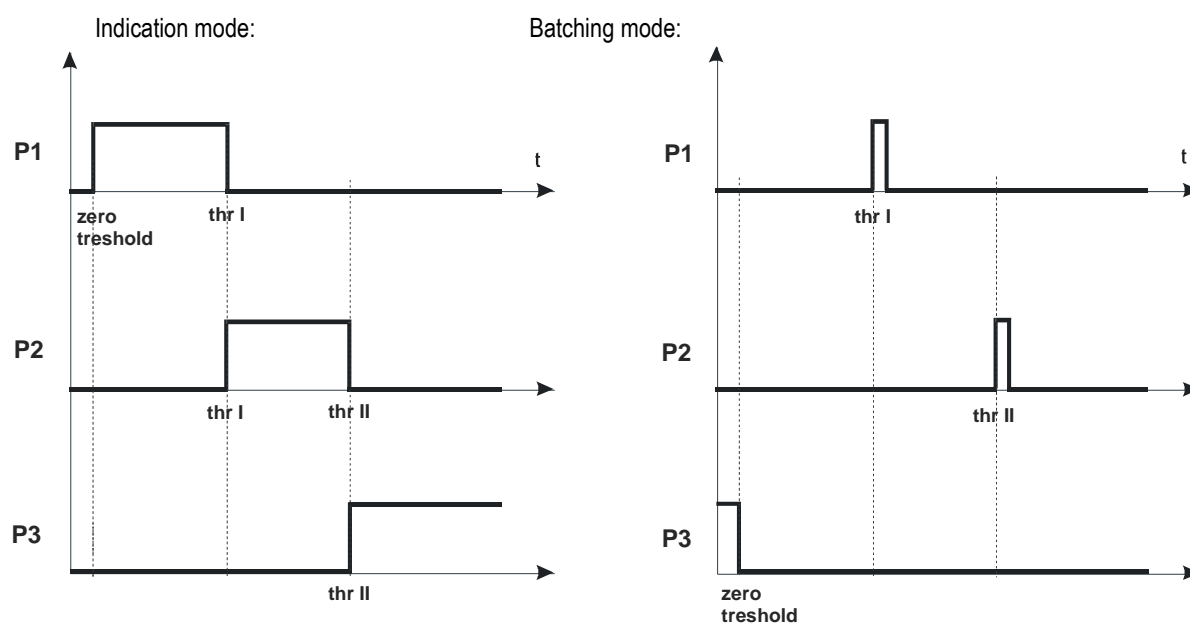

In *Batching mode* on P1 (thr I) and P2 (thr II) outputs short-circuit impulses appears for time of 0,5s. On P3 (zero) output short-circuit state appears when indication does not exceed threshold value signalling zero load.

**Operation sequence:**

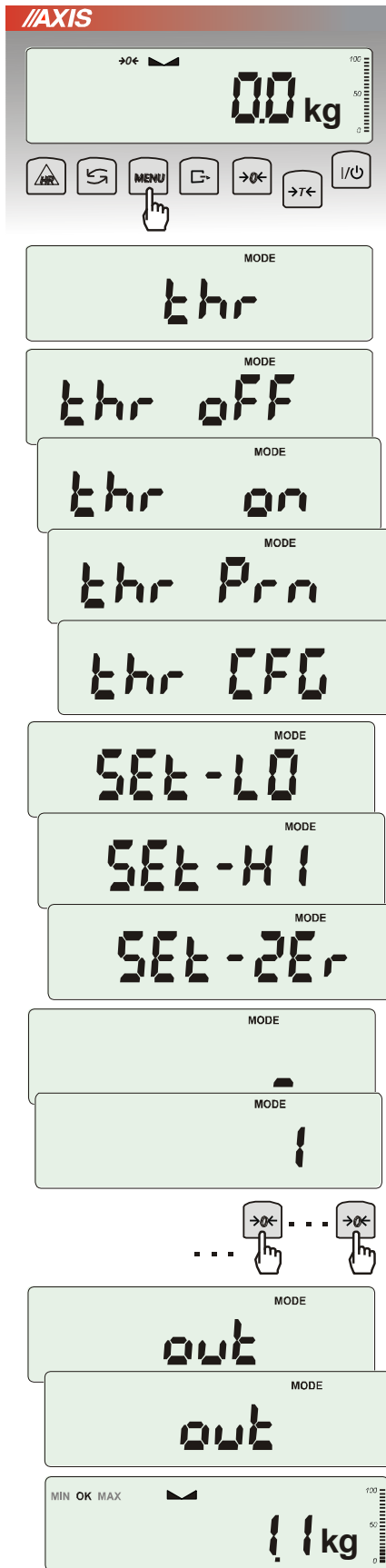

Press *MENU* key and choose *thr* pressing  $\rightarrow T \leftarrow$  key.

The following options are displayed successively:

- *thr off* – deactivate the function,
- *thr on* – activate the function,
- *thr Prn* – check last threshold values (press  $\square \leftarrow$  key several times),
- *thr CFG* – choose *Relays* socket mode:  
*IMPULS* – *Batching* mode  
*SIGnAL* – *Indication* mode  
*out*.

Choose *thr-on* option using  $\rightarrow T \leftarrow$  key. The following options for entering thresholds are displayed:

- *SEt-LO* - set lower threshold value,
- *SEt-HI* - set upper threshold value,
- *SEt-ZEr* - set zero signalisation threshold.

Using  $\rightarrow T \leftarrow$  key select *SEt-LO* option.

Set lower threshold value using the following keys:

- $\rightarrow 0 \leftarrow$  - digit increase,
- $\square \leftarrow$  - decimal point,
- $\rightarrow T \leftarrow$  - move to next digit,
- MENU* - finish.

Then select *SEt-HI* option and enter upper threshold value.

Choosing *SEt-ZEr* option will enter zero signalisation.

Choosing *out* will end inscribing thresholds. Choosing again *out* will start *thr* function.

To change *Relays* socket mode use *thr CFG* option. Default option is *Indication*.

To leave the function, press *MENU* key and then choose *thr* and *thr off* options.

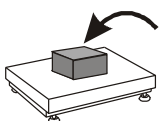

Relays connection diagram:

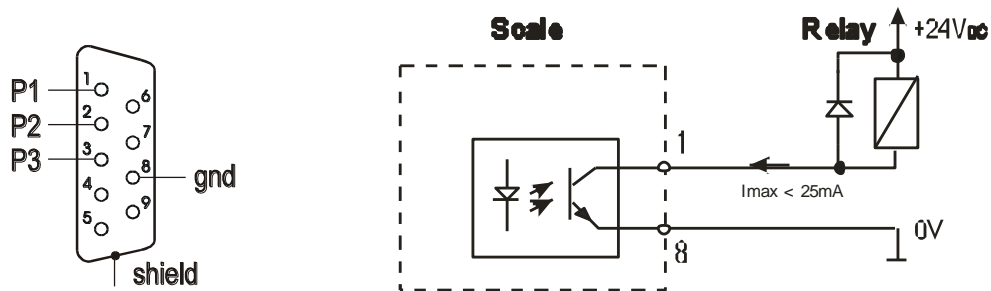

Relays output is the open collector transistor output with load capacity 25mA / 24V. Transmitter inputs must be protected with diodes, e.g. 1N4148.

It is advised to use MS3K/P electronic board (sold separately), consisting of RM96P transmitters, with DC24V input voltage and AC250V, 3A output.

### **Important notes:**

1. After switching the scale on, both thresholds are set to maximum values.
2. When setting upper threshold value, pay attention that its value is not below lower threshold value.
3. Setting lower and upper threshold value is possible after sending appropriate orders from computer, what is described in scale user manual.

## 18.11 Setting date and time function (dAtE)

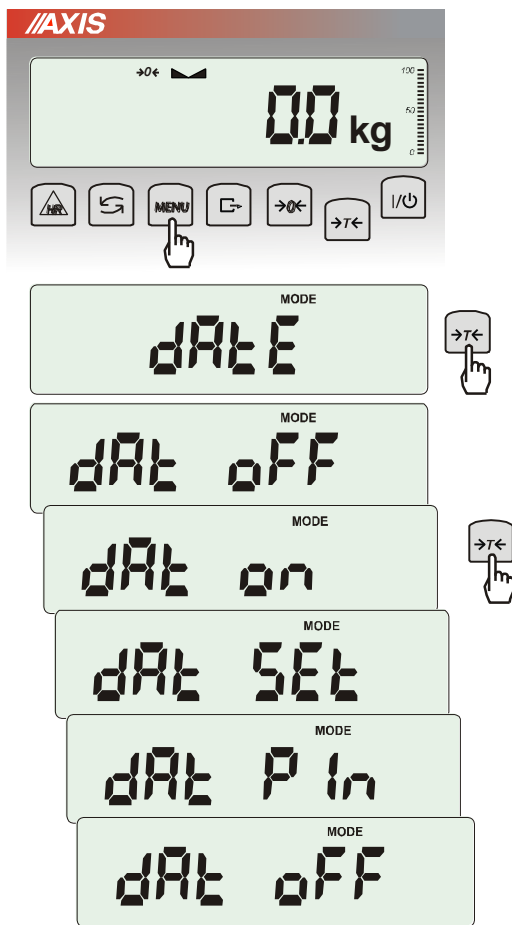

The function allows setting current date and time of scale internal clock and mode of its use.

The function has the following options:

- *dAt off* – deactivate date and time during printout of current weighing result,
- *dAt on* – activate date and time during printout of current indication (→T← key),
- *dAt SEt* - change current date and time,
- *dAt PIn* – data and time secure password (to prevent from changing date and time by unauthorized personnel),
- *dAt For* – data printout in *USA* or *EU* format.

The example at the left presents how to set current date and time using *dAt SEt* option.

After setting proper date and time activate it with *dAt on* option.

*UE: rrrr-mm-dd gg:mm*

*USA: mm-dd-rrrr gg:mm AM/PM*

(gg – hours, mm – minutes, AM – before noon, PM – after noon, mm - month, dd - day, rrrr - year).

**Attention:** Insccribing non-zero *PIN* value causes showing *PIN* sign during next date and time changing and inscribing 4 digit code is necessary. (using keys →0←, →T← and *MENU*).

## 18.12 Radio communication channel choice function (rF CHn)

Function enables choosing radio communication channel between the scale and a pilot. In scale and in pilot the same radio channels must be chosen. Function should be used when communication is disturbed by other devices that use the same communication channel.

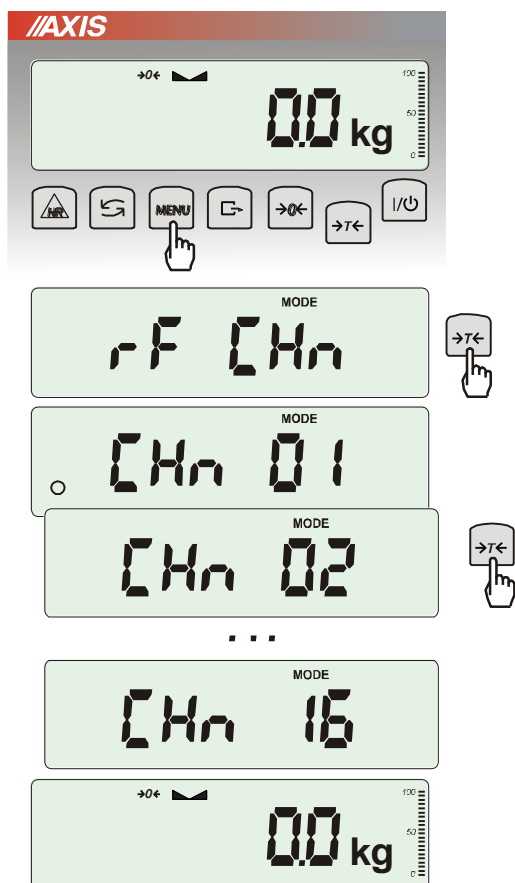

Press *MENU* key and choose *rF CHn* by pressing →T← key.

The following communicates will appear on display: Na wyświetlaczu pojawiają się kolejno:

- *CHn 01* – channel 1,
- *CHn 02* – channel 2
- ...
- *CHn 16* – channel 16
- *out* – out without changing channel.

In default setting channel 01 is on.

### 18.13 Charging accumulators function (bAttErY)- option

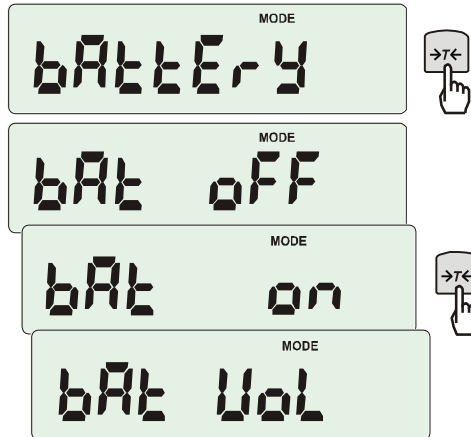
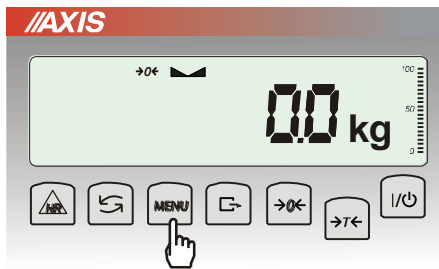

*bAttErY* function allows switching on or off charging accumulators during work with feeder and checking their power level.

The function has the following options:

- *bAt OFF* – charging off (option required if ordinary batteries are used !!!),
- *bAt on* – charging on, accumulators are being charged even after switching scale off using I/ ⏻ key,
- *bAt Vol* – reading power level of accumulators in % (go back to mass indication pressing *MENU* key),
- *out* – leave without changes

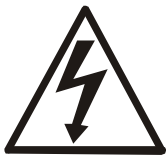

An attempt of charging ordinary batteries can cause serious damage of the scale.



## 18.14 Automatic switching off the scale function (AutoOFF)

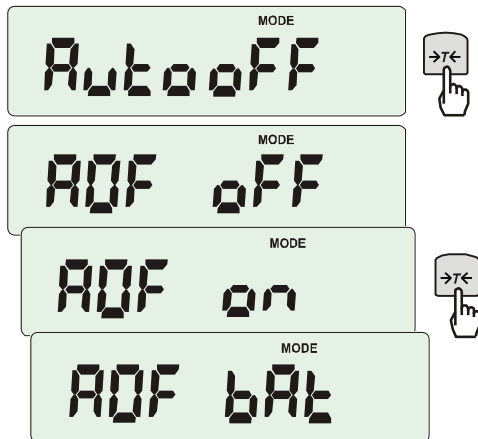
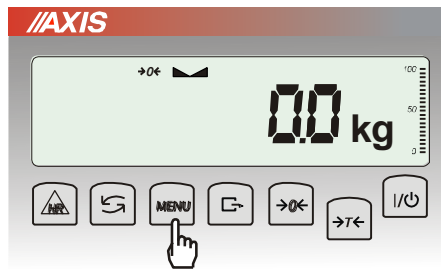

The function is helpful in scales supplied from accumulators. The function causes scale to switch off automatically.

Press *MENU* key.

When *AutoOFF* is displayed press *→T←* key.

The following options appear successively on display:

- *AOF oFF* – deactivate function,
- *AOF on* – activate function- scale turns off after 5 minutes of not making any actions,
- *AOF bAt* – as above but only when supplied from accumulators.
- *Out* – out without changes.

## 18.15 Statistical calculations function (StAt)

This function evaluates from series of measurements (max 1000) statistical parameters of weighting process.

Adding successively measurements to register is automatic and it occur after the scale is loaded and its indications stabilize.

After each loading printout is made with: number of measurements, result, date and time (if clock is installed and the function is activated).

For the obtained measurements series the scale evaluates:

- n                                    -number of samples
- sum x                                -sum of all samples  $sum\_x = \sum x_n$
- $\bar{x}$                                     -average value (sum x)/n
- min                                    -minimal value from n samples
- max                                    -maximal value from n samples
- max-min                               -maximal value minus minima value
  
- S                                        -standard deviation  $S = \sqrt{\frac{1}{(n-1)} \sum_n (x_n - \bar{x})^2}$
- srel                                    -variance factor  $srel = \frac{S}{x}$

Statistical calculations results can be printed.

**Order of operations:**

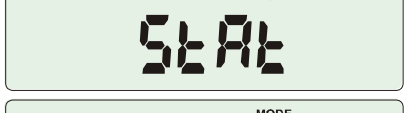
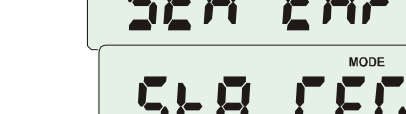
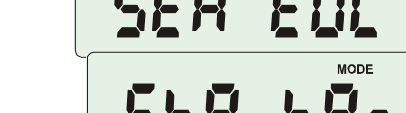
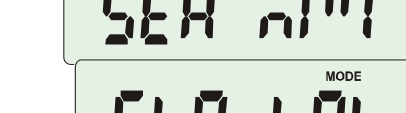
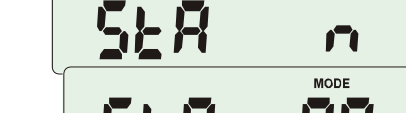
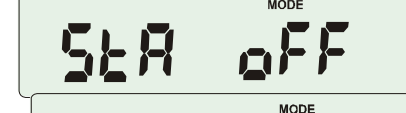
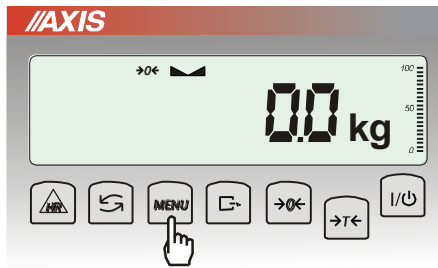

Press MENU key.

When *StAt* is displayed press →T← key.

The following options are displayed:

- *StA Prn* – monitoring and printout of statistical data,
- *StA oFF* – deactivate function,
- *StA □* – activate function, work with printout of chosen weighting results,
- *StA --* – activate function, work without printout,
- *StA n* – maximal samples value,
- *StA nM* – inscribing nominal value for statistics,
- *StA tOL* – inscribing tolerance in %,
- *StA tAr* – automatic tare on/off
- *StA CFg* – function configuration:
  - *Auto* – Automatic work (samples are confirmed after loading the scale and indication stabilization.),
  - *ManuAL* – manual work (confirmation is made by pressing →T← key).
- *out* – exit from function.

Remember first to inscribe nominal weight value and tolerance (mentioned above).

After that, push →T← key when *StA o* is displayed.

Put on successive objects on the pan (remove after indication stabilization) in order to add them to measurements register.

In order to obtain printed statistical results from measurements series press MENU key and →T← key when *StAt* is displayed and later *StA Prn*.

After printout two options are enabled:

- rESET – erasing results,
- Contin – continuation.

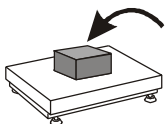

Pressing  key printouts estimated values and histogram :

Nominal - nominal value,

Tolerance - accepted value in percentage.

N - number of sample

IN TOL. – number of samples in toleranc

-TOL – amount of measurements  
under allowable lower value

+TOL – amount of measurements above  
allowable upper value

TOTAL - sum of weights of all n samples

AVERAGE – average weight as (Total)/n

MIN – minimum weight in n samples

MAX– maximum weight in n samples

ST. DEV. – standard deviation

ST. DEV.% – standard deviation percentage

To finish work with this function and zeroing result register press MENU key and then when StAt. and Sta OFF is displayed press →T← button.

Statistics function cooperation with computer and Printer. Scale can be equipped with two serial ports marked as RS232C-I (computer) and RS232C-II (printer). After each data printout by printer identical set of data is sent to computer. After sending by computer initialization signal S A CR LF (53h 49h 0Dh 0Ah) the scale sends to computer statistic data enclosed in histogram.

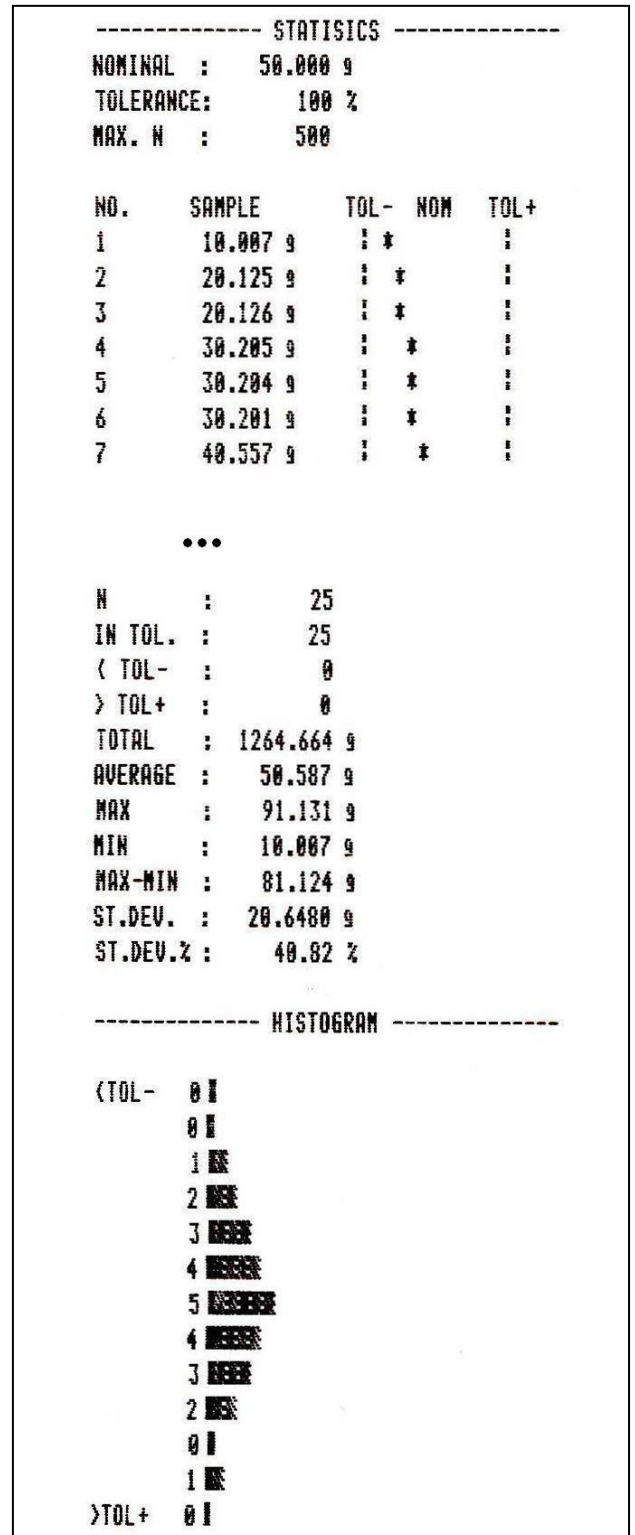

### 18.16 Paperweight calculation (PAP)

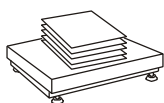
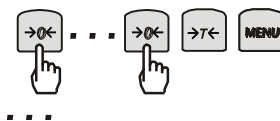
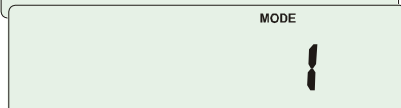
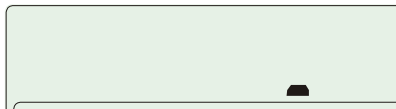
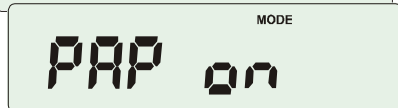
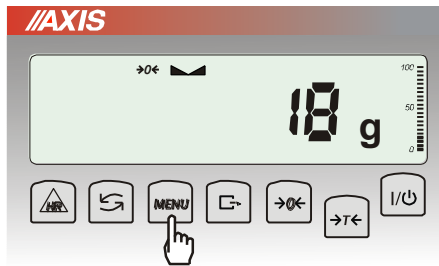
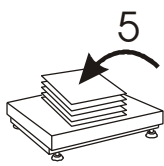

This function enables to calculate paperweight of 1m<sup>2</sup> of paper basing on samples of known area. For quick access, the function is accessible directly by pressing *MENU* key.

The balance must be tared just before the measurement.

Place the specific sample quantity of the same area (possible values: 1, 2, 5, 10, 20, 50, 100).

Press *MENU* key to access Function Menu. To enter the function press  $\rightarrow T \leftarrow$  key when *PAPER* is displayed.

Following options show on the display:

- *PAP oFF* – turn off the function,
- *PAP on* – turn on,
- *PAP n* – inscribing number of paper pieces on pan,
- *PAP ArE* – inscribing surface of single piece (in m<sup>2</sup>)

Press  $\rightarrow T \leftarrow$  key when *PAP n* and *PAP ArE* is displayed.

Enter number of samples using:

- $\rightarrow 0 \leftarrow$  -increasing digit,
- $\rightarrow T \leftarrow$  - next digit,
- MENU* – end of inscribing.

Press  $\rightarrow T \leftarrow$  key when *PAP ArE* is displayed. Enter area of a single sample (as above).

The result of paperweight measurement is finished with „o” mark pointing g/m<sup>2</sup> unit.

In order to finish work with function press *MENU* and then using  $\rightarrow T \leftarrow$  key choose *PAPER* and *PAP oFF*

**Note:**

“PAP Err” communicate marks that wrong values were inscribed in *PAP n* or *PAP ArE*.

## 19. Maintenance and repairs of small defects

15. The scale should be kept clean. The balance must be kept clean and protected from dust, and aggressive liquids. In order to clean it is recommended to wipe the scale with cloth soaked in soapy water and then dry.
16. Take care that no dirt gets between the platform and the scale base. If found any, remove the pan (lift it up), remove dirt and then replace the pan.
17. In case of improper operation caused by short-lasting power supply decay, unplug the scale from the mains and then plug it again after few seconds.
18. If the scale is switched on with empty pan and "SErvic(e)" communicate appears, the load cell has been mechanically damaged.
19. It is forbidden to make any repairs by unauthorised persons.
20. To repair the scale, please contact our nearest service.

### **Error communicates:**

Communicate	Possible cause	Remedy
<i>C-1 ... 6</i> (over 1 min.)	selftests failed	if displayed more than 1 minute, contact an authorised service
unLOAD /SErvic€	the scale was switched on with loaded pan	remove a load from the pan
	mechanical damage of the load cell	contact an authorised service
<i>L</i>	pan missing	put the pan on
	mechanical damage	contact an authorised service
<i>H</i>	overloading	remove the load from the pan
	mechanical damage	contact an authorised service
 indicator does not appear	unstable ground vibrations air flows	place the scale on a stable ground not affected by mechanical vibrations and airflows
	scale is damaged	contact an authorised service
- - - - -	taring in progress	as above
- -	taring could not be finished (the load is too small or B\G key was used)	zero the scale or press B\G key again
- -	the load is too big to be zeroed	tare the scale (→T←)

## Declaration of Conformity

We:

**AXIS** Spółka z o.o. 80-125 Gdańsk, ul.Kartuska 375B declare with full responsibility, that the balance:

*4BA300T and 4BA600T*

marked with **CE** mark comply with the following:

1. EN 61010-1:2004 standard Safety requirements for electrical equipment for measurement, control and laboratory use. General requirements harmonized with the directive 2006/95/WE (Low Voltage Directive),
2. EN 55022:2000 Electromagnetic compatibility (EMC) – information technology equipment – Radio disturbance characteristics - standard Limits and methods of measurement and IEC 61000-4-3 - Electromagnetic compatibility (EMC) - Part 4-3: Testing and measurement techniques - Radiated, radio-frequency, electromagnetic field immunity test harmonized with the directive 2004/108/WE (Electromagnetic compatibility).

Moreover scales with the following markings on the name plate:



- the number of the Notified Body responsible for EC verification \_\_\_\_\_ 1443

- two-digit number of the year of EC verification \_\_\_\_\_

- a green metrology sticker with "M" mark \_\_\_\_\_

- a protective seal affixed by the Notified Body

comply with the requirements on the Type-Approval Certificate No. PL 04 022 and are verified to comply with:

3. EN 45501 norm Metrological aspects of non-automatic weighing instruments and with 2009/23/WE directive.

Additional information

- Conformity evaluation for the Council Directive 73/23/ECC and 89/336/EEC (replaced by 2006/95/WE and 2004/108/WE) was carried out by Laboratorium Badawcze Oddziału Instytutu Elektrotechniki in Gdańsk, accredited by PCA,
- Type-Approval Certificate No. PL 04 022 was issued by Główny Urząd Miar w Warszawie (Notified Body No. 1440).

Per pro Director of AXIS Sp. z o.o.:

Production Manager

Jan Kończak

A handwritten signature in black ink, appearing to read 'Jan Kończak', is written over a horizontal line.

Date: 14-11-2014

## Appendix A

### Information's concerning double-range scale (options)

#### 1. General description

Double-range scale's have capability of work with greatest accuracy in bottom measuring range part. Weighing of smallest mass is more precise.

This type of scale's have two measurement range:

- $Max_1$  - 50 % of maximum load (mostly),
- $Max_2$  – 100% of maximum load,

and adequate reads digit:  $d_1$  i  $d_2$  ( $d_1 < d_2$ ).

Double-range options causes change of scale's operation:

- after turn on (in small mass range 0-  $Max_1$ ) scale displays result with reading unit  $d_1$ ,
- when the load pass the  $Max_1$  scale changes reading unit on  $d_2$ ; from this moment scale displays result with reading unit  $d_2$  on all measure range (0-  $Max_2$ ),
- return to unit  $d_1$  is succeed after zeroing the scale ( $\rightarrow 0 \leftarrow$  key), or when all mass is removed from pan (indicator " $\rightarrow 0 \leftarrow$ ").

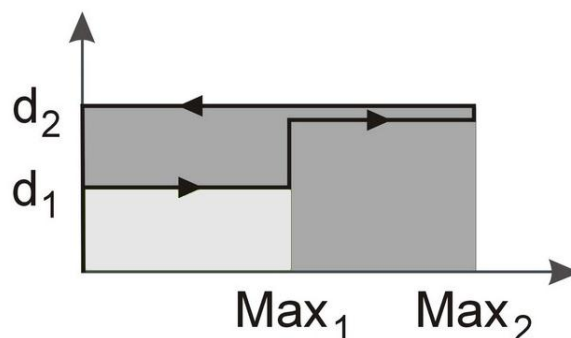

#### 2. Double-range scale parameters

Range and graduation values are represented on nominal table on the scale.



***Notes***