



UltraView UVD-6120VE-2 Digital WDR Dome Camera User Manual

Copyright	© 2012 UTC Fire & Security. All rights reserved.
Trademarks and patents	<p>The TruVision and Interlogix names and logo are trademarks of UTC Fire & Security.</p> <p>Other trade names used in this document may be trademarks or registered trademarks of the manufacturers or vendors of the respective products.</p>
Manufacturer	<p>UTC Fire & Security Americas Corporation, Inc. 2955 Red Hill Avenue, Costa Mesa, CA 92626-5923, USA</p> <p>Authorized EU manufacturing representative: UTC Fire & Security B.V. Kelvinstraat 7, 6003 DH Weert, The Netherlands</p>
Certification	  N4131
FCC compliance	<p>Class A: This equipment has been tested and found to comply with the limits for a Class A digital device, pursuant to part 15 of the FCC Rules. These limits are designed to provide reasonable protection against harmful interference when the equipment is operated in a commercial environment. This equipment generates, uses, and can radiate radio frequency energy and, if not installed and used in accordance with the instruction manual, may cause harmful interference to radio communications. Operation of this equipment in a residential area is likely to cause harmful interference in which case the user will be required to correct the interference at his own expense.</p>
ACMA compliance	<p>Notice! This is a Class A product. In a domestic environment this product may cause radio interference in which case the user may be required to take adequate measures.</p>
European Union directives	<p>12004/108/EC (EMC directive): Hereby, UTC Fire & Security declares that this device is in compliance or with the essential requirements and other relevant provisions of Directive 2004/108/EC</p> <p>2002/96/EC (WEEE directive): Products marked with this symbol cannot be disposed of as unsorted municipal waste in the European Union. For proper recycling, return this product to your local supplier upon the purchase of equivalent new equipment, or dispose of it at designated collection points. For more information see: www.recyclethis.info.</p>
Contact information	<p>For contact information, see www.utcfireandsecurity.com or www.utcfssecurityproducts.eu.</p>



Content

Product overview	2
Package Contents	2
Features	2
User guidelines	2
Product description	3
OSD control pad	3
Installation	5
Mount the camera	5
Connect the cables	5
Adjust the lens	5
Adjust the focus and zoom	6
Programming	7
Access the Main menu	7
General menu	7
AE/WDR/BLC menu	8
WB mode menu	9
D/N mode menu	9
Motion alarm menu	10
Privacy menu	11
Picture adjustment menu	12
Reset camera	12
Specifications	12
Dimensions	13
Menu Map	14

Product overview

The UVD-6120VE-2-XX camera uses a digital signal processor (DSP) to process video signals. The camera includes a microcontroller to provide high-quality images with high-color reproduction and sharp pictures.

Package Contents

The package contains the following:

- Dome camera
- Monitor output cable
- Mounting screws, wall anchors, and hex wrench
- Power terminal
- Ceiling drilling holes template

Note: Use the video output BNC and power jack for normal system operation. Use the monitor output cable for installation and maintenance.

Features

The camera includes the following features:

- EXview HAD II (hole accumulated diode) technology with 480,000 pixels NTSC (570,000 PAL)
- Use of LSI (large scale integration) digital processors to produce 650 lines of horizontal resolution
- Smart digital control automatic BLC (backlight compensation)
- Digital wide dynamic range (WDR)
- Advanced auto exposure system for both fixed iris and auto iris lenses to optimize the amount of light
- Internal synchronization
- Eight privacy mask areas to protect privacy concerns
- Advanced OSD (onscreen display) control
- Signal-to-noise ratio better than 52 dB
- Long life and high reliability
- Isolated switching power 12 VDC and 24 VAC

User guidelines

- Program the camera settings as much as possible before mounting the camera. Take appropriate safety precautions while completing programming after installation.

- Always use a 12 VDC or 24 VAC UL listed Class 2 power supply to power the camera.
- Do not use the camera over the temperature range specifications: - 22 to 122°F (-30 to +50°C).
- If the light source where the camera is installed experiences rapid, wide-variations in lighting, the camera may not operate as intended.

WARNING: To reduce the risk of fire or electronic shock, do not expose the camera to rain or moisture and do not remove the cover or back.

Product description

Figure 1:: Camera description

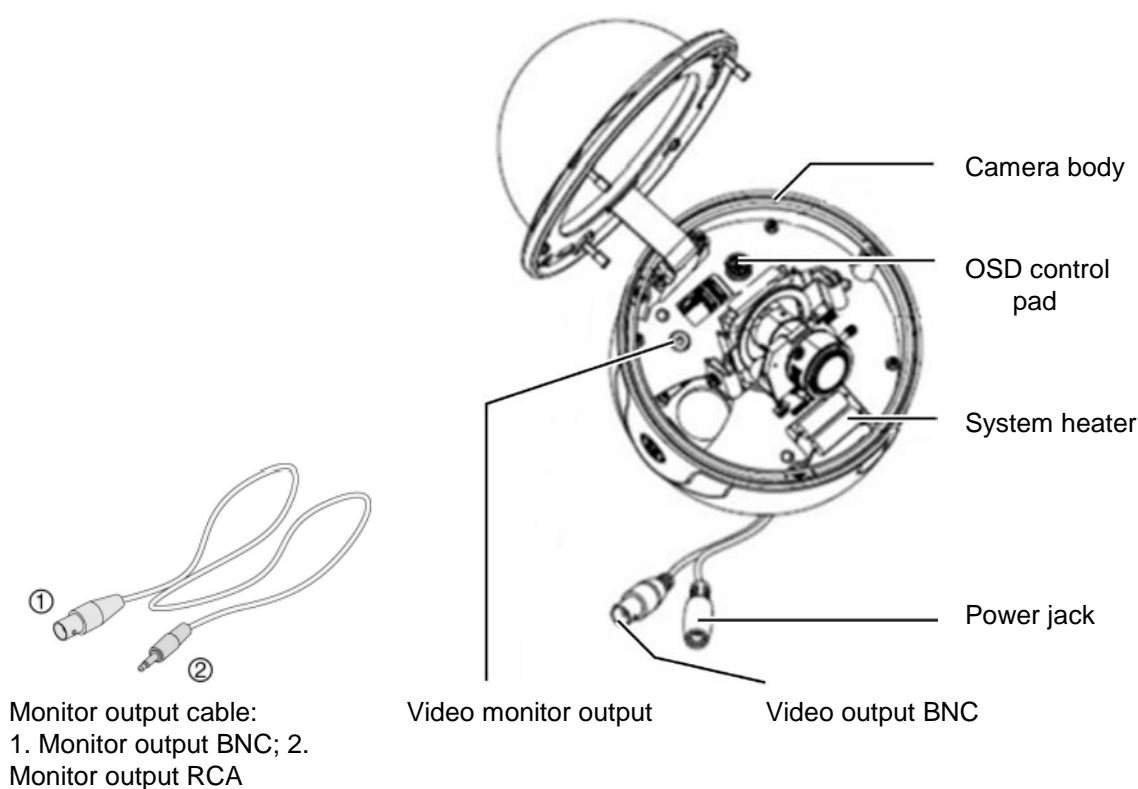

OSD control pad

The onscreen display (OSD) control pad (Figure 3) is a five-direction pad that provides the ability to manually control the camera functions. Table 1 below lists the OSD control pad functions and describes their use.

Figure 2: OSD control pad

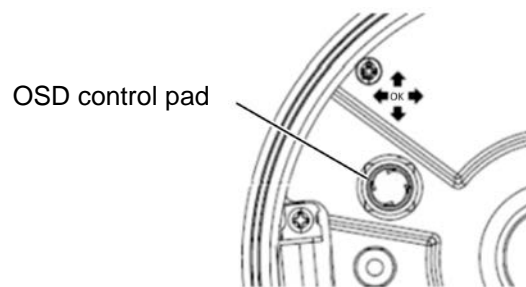

Table 1: OSD control pad functions

Pad directions	Description
Up	Moves the cursor upward to select an item.
Left	Moves the cursor left to select or adjust the options of the selected item.
Right	Moves the cursor to the right to select or adjust the options of the selected item.
Down	Moves the cursor downward to select an item.
Enter	Press the center of the control pad to display the Setup menu. If the selected item has its own menu, press the control pad to enter a submenu. Press the control pad for 2 seconds to save all settings and exit the Setup menu.

Installation

Please check the package contents and make sure that the device in the package is in good condition and all the assembly parts are included.

To install the camera you will need to prepare the mounting surface, mount the camera, make cable connections, adjust the lens and then secure the dome cover securely.

Note: Before installing, please ensure that the mounting surface is strong enough to withstand three times the weight of the camera. If the mounting surface is not strong enough, the camera may fall and cause serious damage.

Mount the camera

Use the ceiling drilling holes template and mark the holes on the ceiling with a pen. Attach the plate with fasteners to the ceiling and then attach the camera body to the plate.

To mount the camera, attach the camera to the mounting surface using the appropriate fasteners.

Connect the cables

To connect the cables:

1. Connect a coaxial cable from the camera's BNC connector to a CCTV monitor or video recording device.
2. Connect the 12 VDC or 24 VAC power supply to the power jack of the camera.

Caution: Check for polarity when using a 12 VDC power supply.

Adjust the lens

The camera is mounted on a pan-tilt-twist (3-axis gimbal) rotating platform so that it is easy to adjust the camera orientation. See Figure 3 on page 6.

Figure 3: Camera adjustment

Platform horizontal adjustment (0 to 180°)

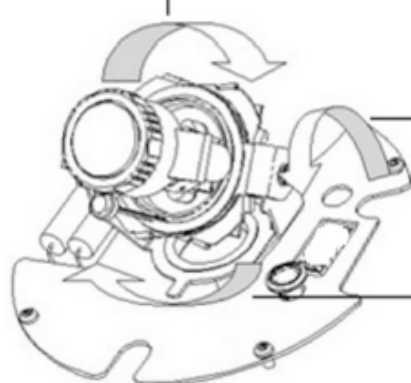

Platform vertical adjustment (0 to 90°)

Rotor horizontal adjustment (0 to 350°)

To adjust the lens:

See Figure 3 above.

1. To adjust the horizontal angle of the platform up to 180 degrees, turn the platform.
2. To adjust the horizontal angle of the rotor up to 350 degrees, turn the rotor on the platform.
3. To adjust the vertical angle of the platform up to 90 degrees, turn the platform.

Adjust the focus and zoom

Figure 4: Zoom and focus adjustment

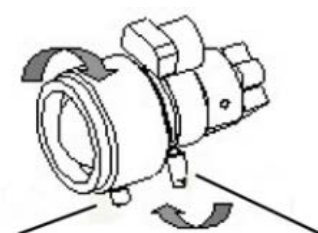

Zoom ring thumbscrew

Focus ring thumbscrew

To adjust the camera zoom and focus:

1. Loosen the zoom ring thumbscrew and turn the zoom ring to set the desired zoom. Tighten the thumbscrew.
2. Loosen the focus ring thumbscrew and turn the focus ring to set the desired focus. Tighten the thumbscrew.

Programming

Access the Main menu

The Main menu provides access to the camera configuration options. The on-screen display (OSD) is only available in English.

Program the camera by attaching a standard video monitor to the system.

Figure 5: The Main menu

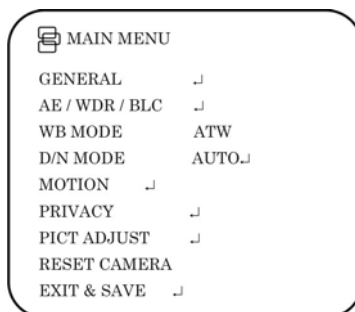

To access the menus:

1. Press the OSD control pad to access the Main menu and its submenus.
2. Push the pad up, down, left and right to move between menu options.
3. Press the OSD control pad (**Enter**) to select an option.
4. When in a sub menu, select **Return** to return to the previous menu.
5. To exit the Main menu, move the cursor to **Exit** at the bottom of the screen and press **Enter**. All changes are saved.

General menu

Select the **General** option from the Main menu to enter the General menu.

Figure 6: The General menu

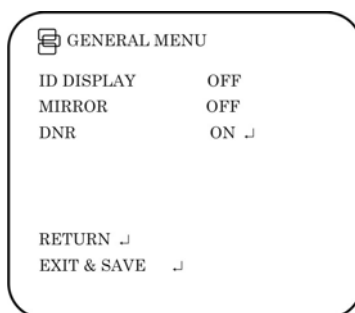

Table 2: General menu

Parameter	Description
ID display	Displays the camera ID on screen. Default option is Off.
Mirror	Flips the camera image so that it is correctly orientated for viewing.

Parameter	Description
	Default option is Off.
DNR	Digital noise reduction (DNR) improves the image quality in low light levels. When enabled, select the Y and C filter strength: Press Return to return to the previous menu or Exit & Save to save changes and return to live mode. Default option is On.
Return	Press Enter to return to the previous menu.
Exit & Save	Exits the menu and returns to live mode. Saves changes made.

AE/WDR/BLC menu

Select the **AE/WDR/BLC** option from the Main menu to enter the AE menu.

Figure 7: The AE/WDR/BLC menu

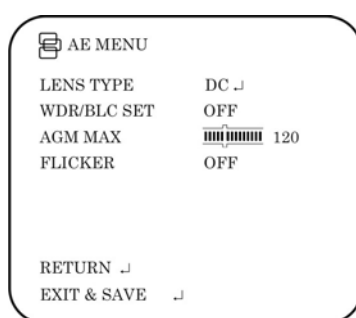

Table 3: AE/WDR/BLC menu

Menu item	Description
Lens type	Defines the lens type used with the camera. Select Fixed or DC . If DC is enabled, select the DC level and shutter speed from the options shown.
WDR/BLC set	Wide dynamic range (WDR) allows you to see details of objects in shadows or details of objects in bright areas of frames that have high contrast between light and dark areas such as the headlights of a passing car. Backlight compensation (BLC) function improves image quality when the background illumination is high. It prevents the object in the center from appearing too dark. Options are: <ul style="list-style-type: none"> • Off • WDR: Set the luminance level (Low, Middle, High) • BLC fix: set the BLC level (between 1 and 30) and the BLC window.
AGC max	Defines the automatic gain control (AGM). Select a value between 0 and 160.
Flicker	This feature to prevent the strobing effect under certain lighting conditions/shutter speeds. Default option is Off.
Return	Press Enter to return to the previous menu.
Exit & Save	Exits the menu and returns to live mode. Saves changes made.

WB mode menu

White balance (WB) tells the dome camera what the color white looks like. Based on this information, the dome camera will then continue to display all colors correctly even when the color temperature of the scene changes such as from daylight to fluorescent lighting, for example.

Select the **W/B Mode** option from the Main menu to enter the WB Mode menu.

Figure 8: AE/WDR/BLC menu

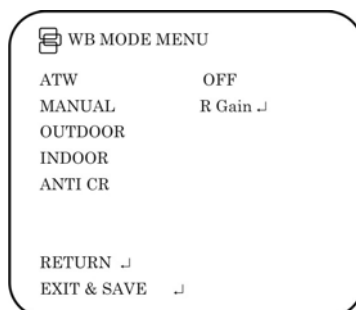

Table 4: AE/WDR/BLC menu

Menu item	Description
ATW	The auto track white balance (ATW) function automatically adjusts the WB in real time as the lighting conditions change. It can be used for both indoor and outdoor locations.
Manual	Manually fix the white balance by adjusting the blue and red gain parameters. Only use this function when there is steady light. Values can be adjusted between -5 and +5.
Outdoor	Select this option to optimize the WB for outdoor sunlit applications. The ATW compensates for high color temperature such as daylight.
Indoor	Select this option to optimize the WB for indoor applications. The ATW compensates for low color temperature such as incandescent lighting.
Anti CR	The anti-color rolling mode function minimizes the color changes over long periods caused by very small differences between the flicker frequency of non-inverter fluorescent lights and the drive frequency of the image sensor devices.
Return	Press Enter to return to the previous menu.
Exit & Save	Exits the menu and returns to live mode. Saves changes made.

D/N mode menu

This camera function controls when the dome camera switches to day or night mode. The dome camera produces high-quality color video during the day or when light levels are high. At night or when light levels are low the camera switches monochrome and removes the infrared filter to improve IR sensitivity.

Select the **D/N Mode** option from the Main menu to enter the D/N mode menu.

Table 5: D/N mode menu

Menu item	Description
Auto	<p>When set to Auto Day/Night mode, the camera produces high-quality color video during the day or when light levels are high. It then switches to monochrome and removes the infrared filter to improve IR sensitivity at night or when light levels are low. Set following parameters:</p> <p>Day→Night: Set the threshold level on how dark it should be before switching from Day to Night mode. Lower (Higher) value makes the camera switched from Day to Night at lower (higher) illumination</p> <p>Night→Day: Set the threshold level on how light it should be before switching from Night to Day mode.</p> <p>Delay seconds: This is the time in seconds before Day↔Night switches. A long delay response would be used, for example, to avoid switching from Night to Day mode when car headlights pass in front of the camera.</p> <p>CAUTION: If there is a minimal difference between the Day→Night and Night→Day values, then camera may switch between Day and Night mode repeatedly.</p>
Day	Manually select Day mode only. The camera can only be in Day mode.
Night	Manually select Night mode only. The camera can only be in Night mode.
Ext	Externally triggered D/N.
Return	Press Enter to return to the previous menu.
Exit & Save	Exits the menu and returns to live mode. Saves changes made.

Motion alarm menu

A motion detection alarm is an alarm that is triggered when the camera detects a motion. You can define up to four areas on screen where the motion can be detected as well as the level of sensitivity to motion.

Select the **Motion** option from the Main menu to enter the Motion menu.

Figure 9: Motion menus

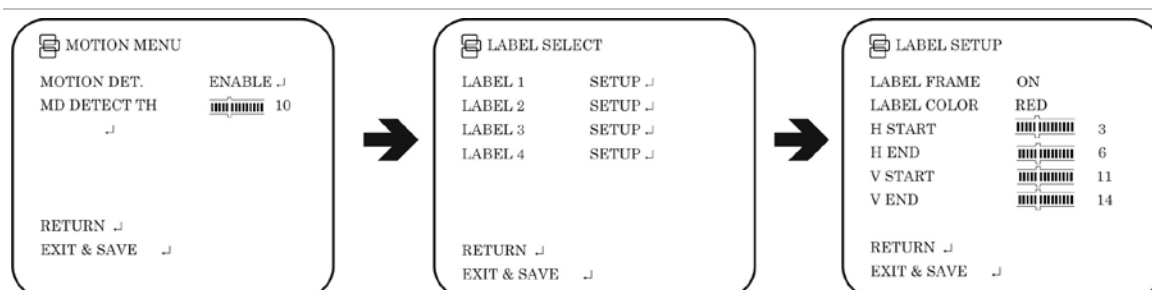

Table 6: Motion alarm menu

Menu item	Description
Motion Detec.	<p>When enabled, you can set up four motion detection areas (Labels) on screen.</p> <p>For each label set the following parameters:</p> <ul style="list-style-type: none"> • Label frame: On/Off • Label color: Blue / Pink / Yellow / Cyan / Coffee / White / Red / Green • H Start: Start of horizontal position 0 to 23 • H End: End of horizontal position 0 to 23 • V Start: Start of vertical position 0 to 23 • V End: End of vertical position 0 to 23 • Return: Press Enter to return to the previous menu • Exit & Save: Exits the menu and returns to live mode. Saves changes made
MD Detect. Th	<p>Defines the motion or face threshold.</p> <p>Select a value between 0 and 127. A lower value means detection is more sensitive.</p>
Return	Press Enter to return to the previous menu.
Exit & Save	Exits the menu and returns to live mode. Saves changes made.

Privacy menu

Privacy masks let you conceal sensitive areas (such as neighboring windows) to protect them from view on the monitor screen and in the recorded video. The masking appears as a blank colored area on screen. You can create up to 4 privacy masks.

Select the **Privacy** option from the Main menu to enter the Privacy menu.

Figure 10: Privacy mask menus

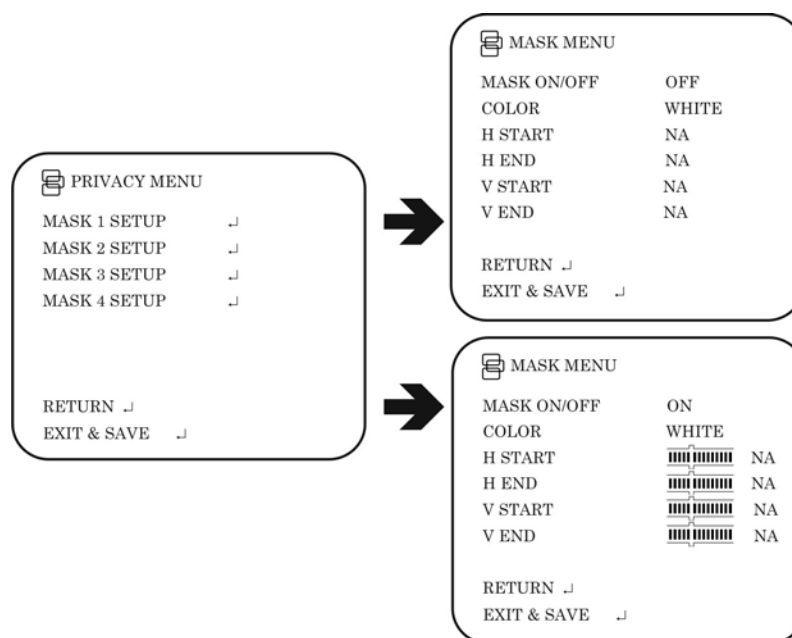

Table 7: Privacy menu

Menu item	Description
Mask 1 Setup	When enabled, you can set up four privacy mask areas on screen.
Mask 2 Setup	For each mask set the following parameters:
Mask 3 Setup	• Mask: On/Off
Mask 4 Setup	• Color: Blue / Pink / Yellow / Cyan / Coffee / White / Red / Green
	• H Start: Start of horizontal position 0 to 500
	• H End: End of horizontal position 0 to 500
	• V Start: Start of vertical position 0 to 280
	• V End: End of vertical position 0 to 280
	• Return: Press Enter to return to the previous menu
	• Exit & Save: Exits the menu and returns to live mode. Saves changes made
Return	Press Enter to return to the previous menu.
Exit & Save	Exits the menu and returns to live mode. Saves changes made.

Picture adjustment menu

Set the camera image characteristics such as brightness, contrast, sharpness, hue, and saturation (called “Gain” here) of the picture.

Select the **Pict Adjust** option from the Main menu to enter the Picture menu.

Figure 11: Picture adjustment menu

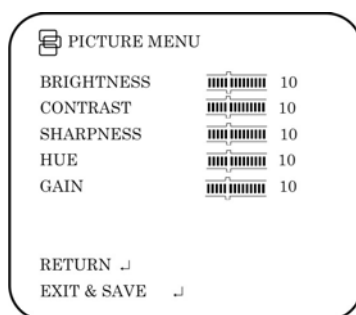

Reset camera

Use this function to restore the camera parameters to the factory defaults values. Select the **Reset** option from the Main menu to restore factory default values.

Specifications

Model	UVD-6120VE-2-P / UVD-6120VE-2-N
Lens type	Varifocal: 2.8 to 10 mm
Power supply	24 VAC / 12 VDC
Current	250 mA. Max: 400 mA (heater on)

Model	UVD-6120VE-2-P / UVD-6120VE-2-N
Power consumption	3 W Max: 9.6 W (heater on)
Operating temperature	-30 to +50°C (- 22 to 122°F)
Weight	1130 g (2.49 lbs)

Dimensions

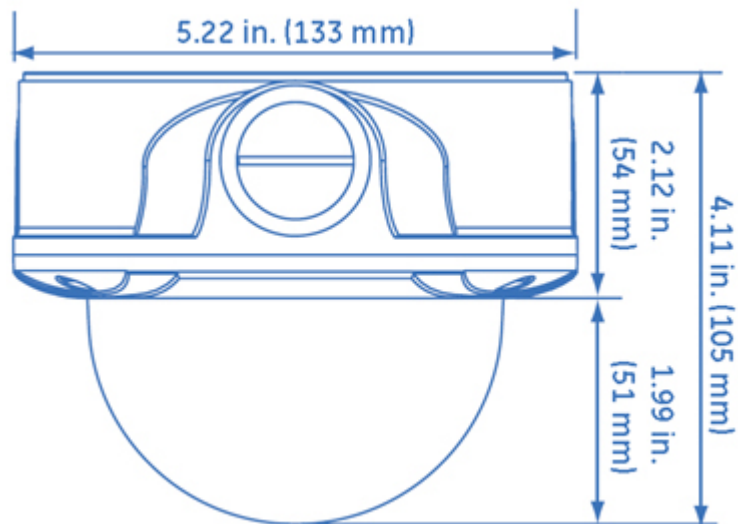

Menu Map

