

# INSTALLATION MANUAL

## ***V-NET***

- Please read this installation manual completely before installing the product.
- Installation work must be performed in accordance with the national wiring standards by authorized personnel only.
- Please retain this installation manual for future reference after reading it thoroughly.

TYPE : Dry contact for demand control  
MODEL : PQDSBCDVM0

# TABLE OF CONTENTS

■ Safety Precautions.....	3
■ Name of each part .....	5
■ Accessory Parts.....	6
■ Installation Method.....	7
■ Setting and using method.....	8
1. Power source input .....	8
2. System structure .....	9
3. Connection with Outdoor unit .....	11
4. Setting of input signal.....	12
5. Setting of 'SWDIP'.....	14
6. Setting of 'SW_STEP' .....	15
7. Setting of 'SW_Address' .....	18
8. Outdoor unit monitoring.....	19

# Safety Precautions

To prevent injury to the user or other people and property damage, the following instructions must be followed.

- Incorrect operation due to ignoring instruction will cause harm or damage. The seriousness is classified by the following indications.

**⚠ WARNING** This symbol indicates the possibility of death or serious injury.

**⚠ CAUTION** This symbol indicates the possibility of injury or damage.

- Meanings of symbols used in this manual are as shown below.

	<b>Be sure not to do.</b>
	<b>Be sure to follow the instruction.</b>

## ⚠ WARNING

### ■ During installation

**Do not touch the board when the power is connected.**

- It can cause a fire, electric shock, explosion, injury and problem to the product.

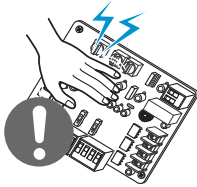

**Always request for installation of the product to the service center or the installation service provider.**

- It can cause a fire, electric shock, explosion and injury.

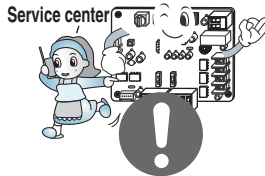

**When reinstalling the previously installed product, request for service to the service center or the installation service provider.**

- It can cause a fire, electric shock, explosion and injury.

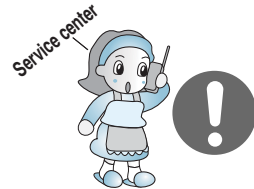

**Do not install the product where it can be exposed to rain.**

- It can cause problems to the product.

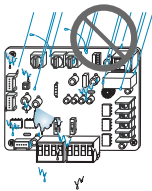

**Do not install the product in a humid location.**

- It can cause problems to the product.

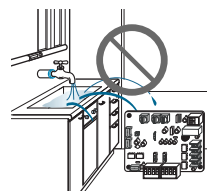

■ During use

**Do not modify or extend the power cord.**

- It can cause a fire and electric shock.

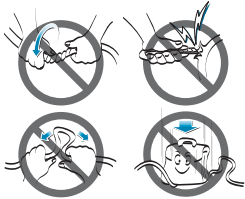

**Do not use any flaming devices near the product.**

- It can cause a fire.

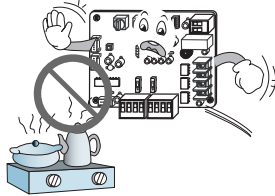

**Do not use any heating devices near the power cord.**

- It can cause a fire and electric shock.

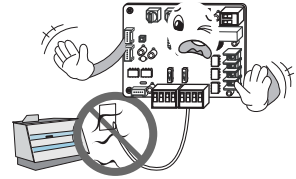

**Do not pour water inside the product.**

- It can cause an electric shock and problem to the product.

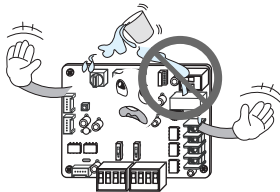

**When the product is submersed in water, always request for service to the service center or the installation service provider.**

- It can cause a fire and electric shock.

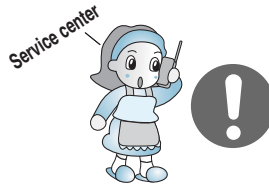

**Make the children and the elderly use the product with the help of a guardian.**

- It can cause a safety accident and problems to the product.

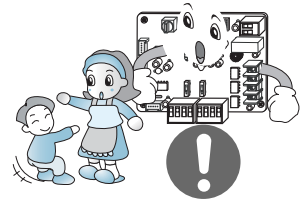

**Do not give impact to the product.**

- It can cause problems to the product.

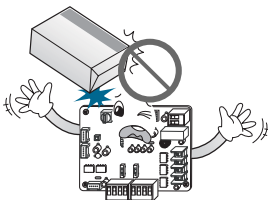

# Name of each part

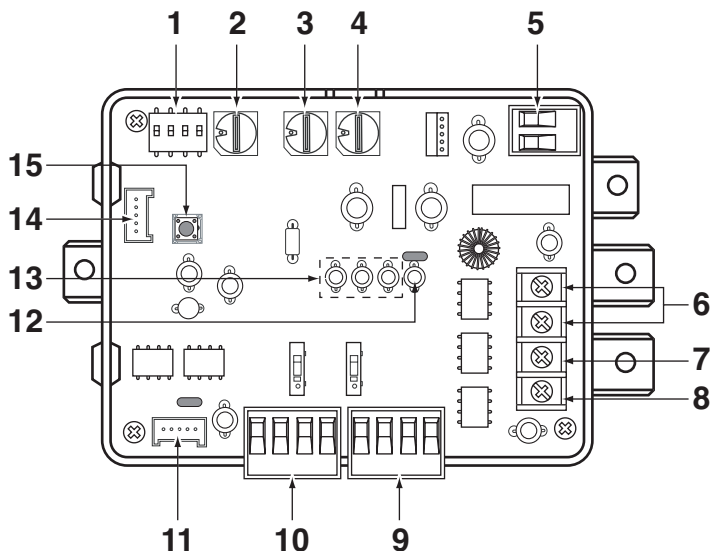

## DRY CONTACT FOR DEMAND CONTROL

1. **SWDIP** : Switch to select main function
2. **SW\_Address2** : Switch to set a upper address of the outdoor unit
3. **SW\_Address1** : Switch to set a lower address of the outdoor unit
4. **SW\_STEP** : Switch to select a control mode.
5. **CN\_PWR** : DC Input terminal
6. **ERROR** : Error display with relay contact
7. **BUS-A** : RS-485 (+) Terminal
8. **BUS-B** : RS-485 (-) Terminal
9. **CN\_CAPACITY** : Signal input terminal to control a capacity of outdoor unit
10. **CN\_SPEED/CAP** : Signal input terminal for Analog Input/Low noise operation
11. **CN\_OUT** : Outdoor unit connector
12. **LED1** : Display LED for RS-485 status
13. **LED01G,02G,03G** : Display LED for communication status
14. **CN\_JIG** : Connector for writing program
15. **SW1** : Reset switch

# Accessory Parts

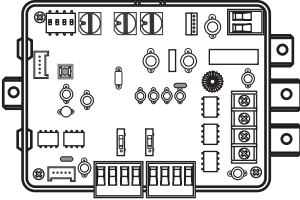
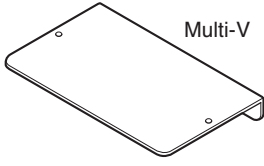
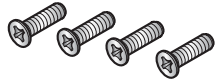
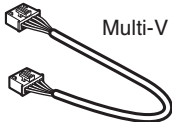
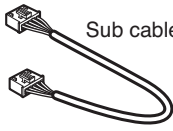
 <p>ODU Dry contact PQDSBCDVM0</p>	 <p>Multi-V</p> <p>BRACKET (1EA)</p>	 <p>SCREW (4EA)</p>
 <p>Multi-V</p> <p>WIRE ASSY 1(1EA)</p>	 <p>Sub cable</p> <p>WIRE ASSY 2(1EA)</p>	

**Others :** Tie Wrap (3 EA) - Cable Tie  
Clamp (1 EA)

# Installation Method

- ① Connect the connection wires according to the instructions.  
(Please refer to Setting and Using Method)
- ② Perform the switch setting according to switch setting method.  
(Please refer to Setting and Using Method)
- ③ Fix the Dry contact on suitable space inside of the outdoor unit.

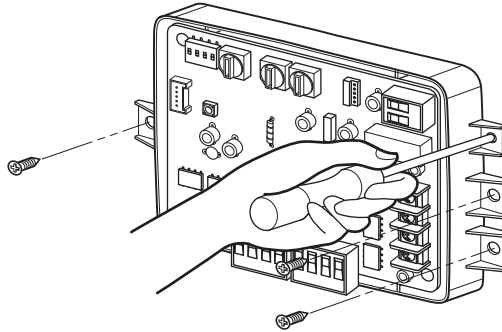

## ⚠ CAUTION

1. Install the product on flat surface and screw at least 2 places. Otherwise the Dry contact may not be anchored properly.
2. Do not screw too tightly. It may cause deformation of the case.
3. Do not deform the case at random. It may cause malfunction of the Dry contact.

# Setting and using method

After change any Dry contact setting, then you must press RESET switch to reflect the setting.

## 1. Power source input

### ■ When wiring power source from outdoor unit

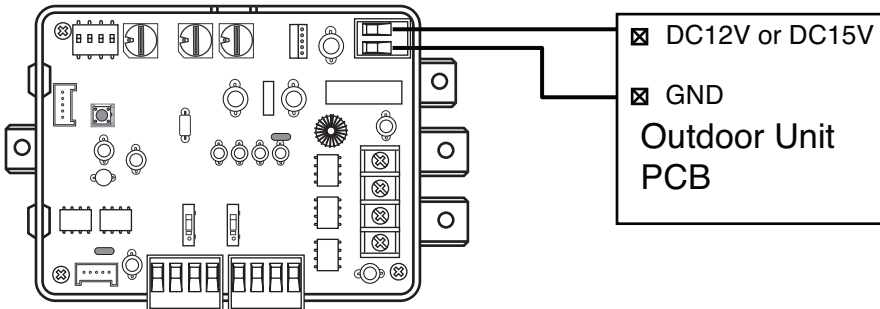

### ■ When using external power source

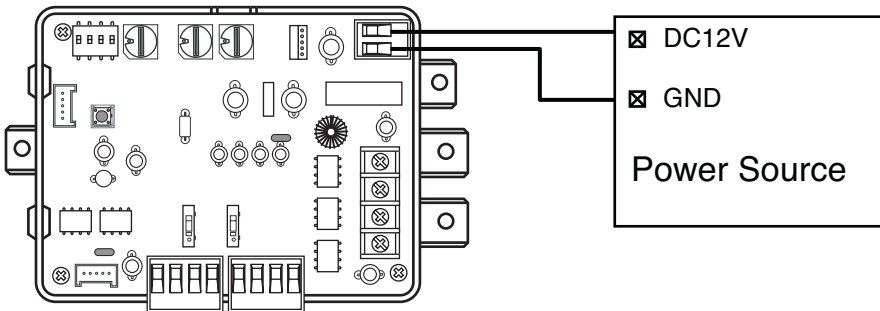

#### Notes

This device can accept only DC Power input.

Do not input 220VAC. Otherwise It will cause a serious damage.



## 2. System structure

### ■ When outdoor unit has RS-485 communication function (Master Mode)

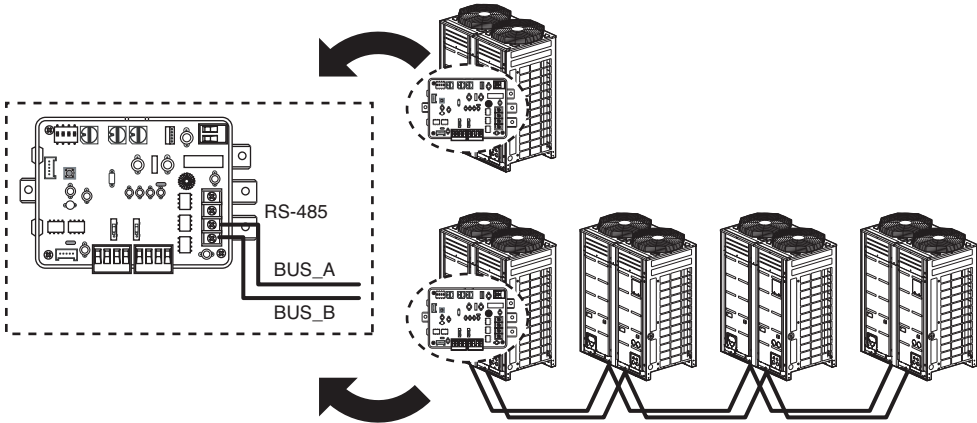

### ■ When outdoor unit doesn't have RS-485 communication function (Slave Mode)

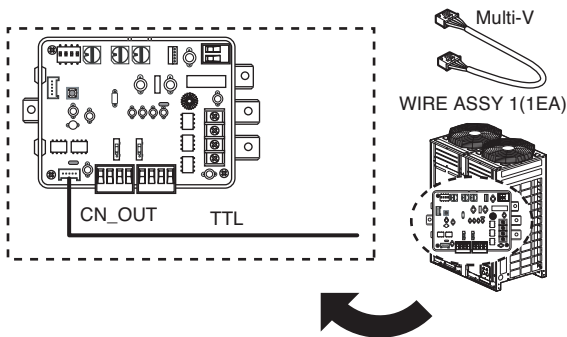

#### Notes

This dry contact module is available after MultiV3 series.

## ■ When using ODU Dry contact with Central Control Devices (Slave Mode)

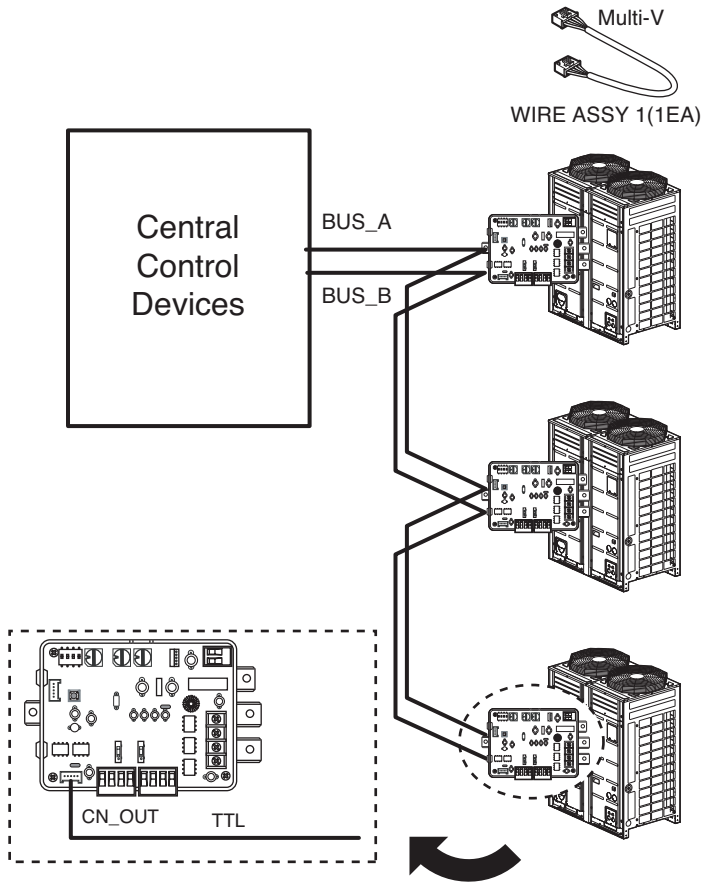

### Notes

This dry contact module is available after MultiV3 series.

### 3. Connection with Outdoor unit

#### ■ When outdoor unit has RS-485 communication function (RS-485 Built-in model)

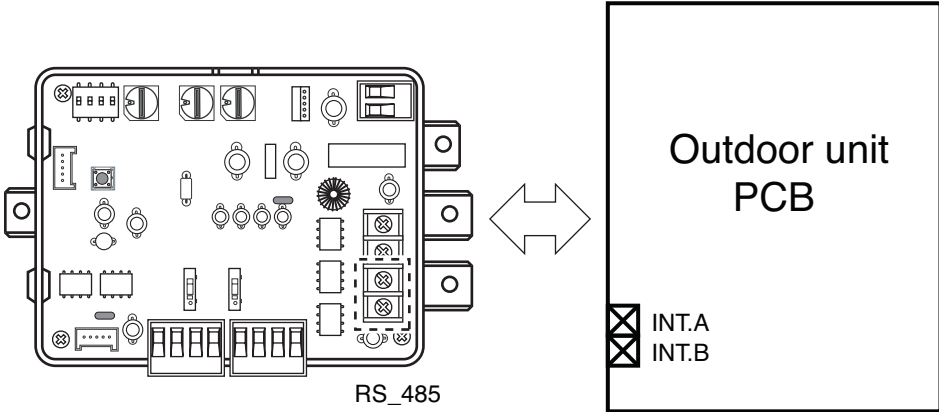

#### ■ When outdoor unit doesn't have RS-485 communication function

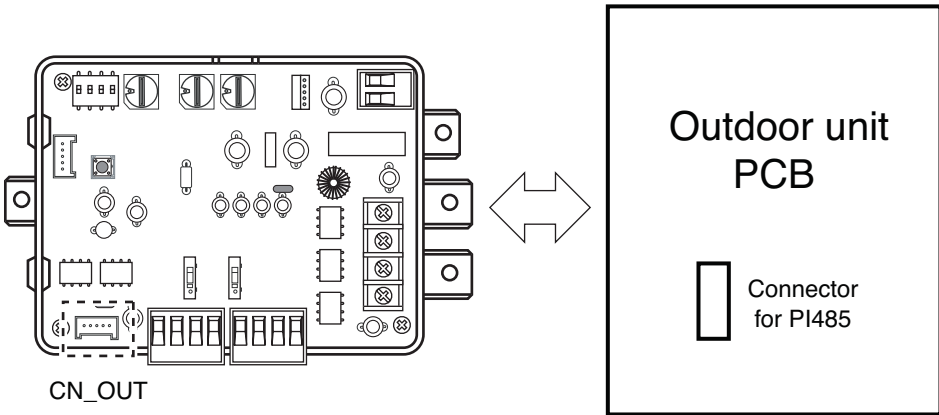

## 4. Setting of input signal

### ■ When using contact signal input without external power

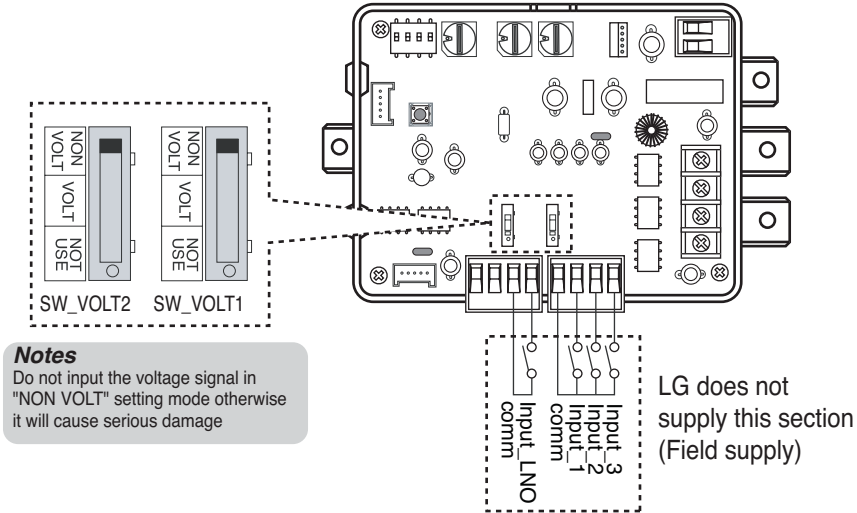

### ■ When using contact signal input with external power

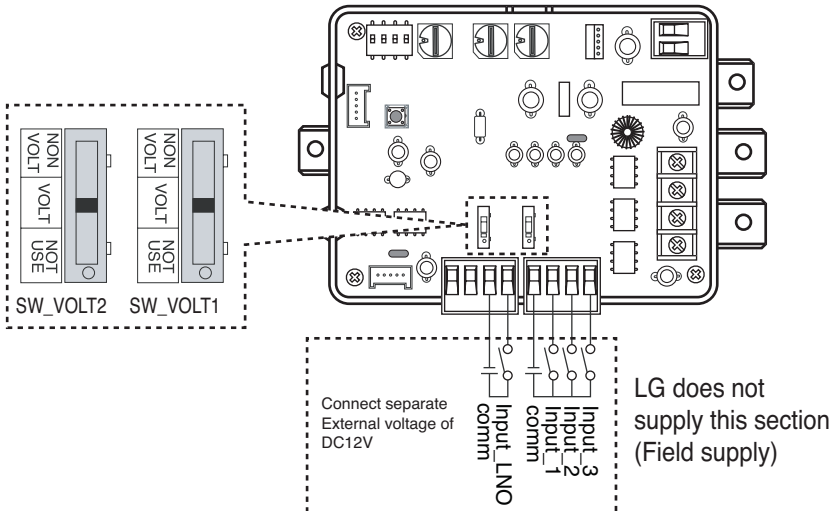

## ■ When using analog input signal

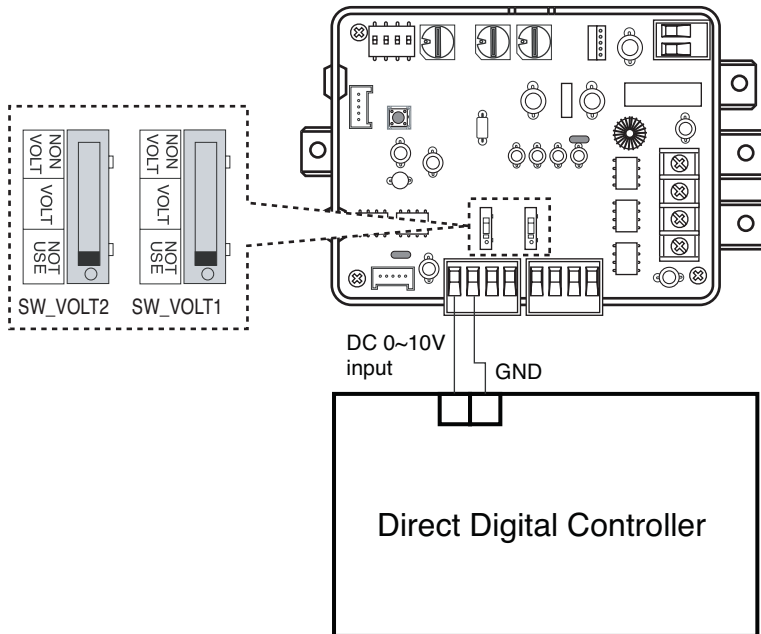

### Notes

- When using an analog signal, Central control Devices can not be used together.  
Do not use signal cable over 1meter.
- Do not change a command too quickly.  
Keep the command 30 seconds at least, otherwise it will cause a damage to outdoor unit.
- This function is very sensitive to supplied power.  
So when using analog inputs, supply a constant-voltage by external power source.

## 5. Setting of 'SWDIP'

■ Using 'SWDIP', select the option of control function as described below

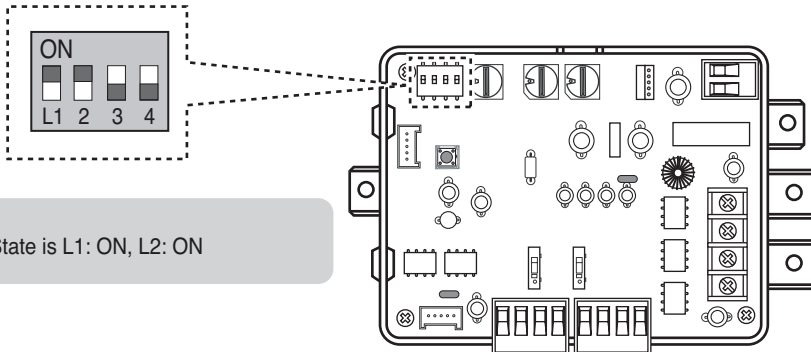

**Notes**

Default State is L1: ON, L2: ON

Position	Function
	ON : Master Mode OFF : Slave Mode
	ON : Enable Low Noise Operation OFF : Disable Low Noise Operation
	No Function
	ON : On Boarding Mode OFF: No Function

**Notes**

After change 'SWDIP' setting, then you must press reset switch to reflect the setting.

## 6. Setting of 'SW\_STEP'

### ■ Use the 'SW\_SETP' to set a control step for contact signal input.

: The type of input signal and control step can be set using 'SW\_STEP'

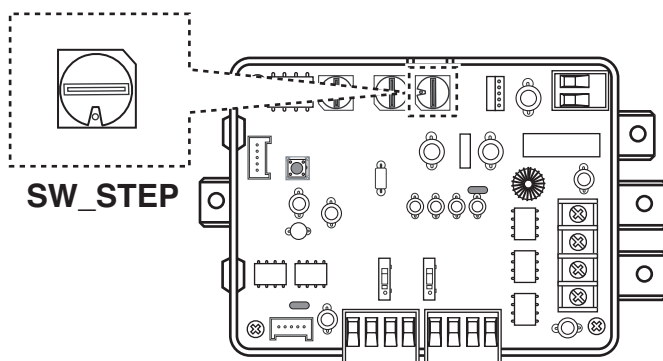

#### - Type of input signal

SW_STEP	Input Signal
0, 1, 2, 3, 4, 5, 6	Contact signal input
D	Analog input signal

#### - Detail of the control step for contact signal input

SW_STEP	Input_1	Input_2	Input_3	Comp capacity Of outdoor unit(%)	Type of input
0	0	0	0	No control	Contact signal
	1	0	0	70	
	0	1	0	40	
	0	0	1	COMP OFF	
1	0	0	0	No control	Contact signal
	1	0	0	70	
	0	1	0	50	
	0	0	1	COMP OFF	
2	0	0	0	No control	Contact signal
	1	0	0	80	
	0	1	0	50	
	0	0	1	COMP OFF	

SW_STEP	Input_1	Input_2	Input_3	Comp capacity Of outdoor unit(%)	Type of input
3	0	0	0	No control	Contact signal
	1	0	0	70	
	0	1	0	40	
	0	0	1	ALL OFF	
4	0	0	0	No control	Contact signal
	1	0	0	70	
	0	1	0	50	
	0	0	1	ALL OFF	
5	0	0	0	No control	Contact signal
	1	0	0	80	
	0	1	0	50	
	0	0	1	ALL OFF	
6	0	0	0	No control	Contact signal
	1	0	0	50	
	0	1	0	COMP OFF	
	0	0	1	ALL OFF	

**Notes**

- Do not change a command too quickly.  
Keep the command 30 seconds at least, otherwise it will cause a damage to outdoor unit.



**- Detail of the control step for analog input signal**

SW_STEP	Input Voltage	Comp capacity Of outdoor unit(%)	Type of input
D	0	No control	Analog input
	1	100	
	2	90	
	3	80	
	4	70	
	5	60	
	6	50	
	7	45	
	8	40	
	9	COMP OFF	
	10	ALL OFF	
E	0	COMP OFF	
	1	40	
	2	45	
	3	50	
	4	60	
	5	70	
	6	80	
	7	90	
	8	100	
	9	100	
	10	100	

**Notes**

- Do not change a command too quickly.  
Keep the command 30 seconds at least, otherwise it will cause a damage to outdoor unit.

## 7. Setting of 'SW\_Address'

### ■ Use the 'SW\_Address' to set an address of outdoor unit

#### - Master Mode

use SW\_ADDRESS2 to set a group(0~F)

If you set a group as "0", the address of outdoor unit should be "00~0F"

#### - Slave Mode (when using with central control device)

use all to set the address of outdoor unit for sending to central control device.

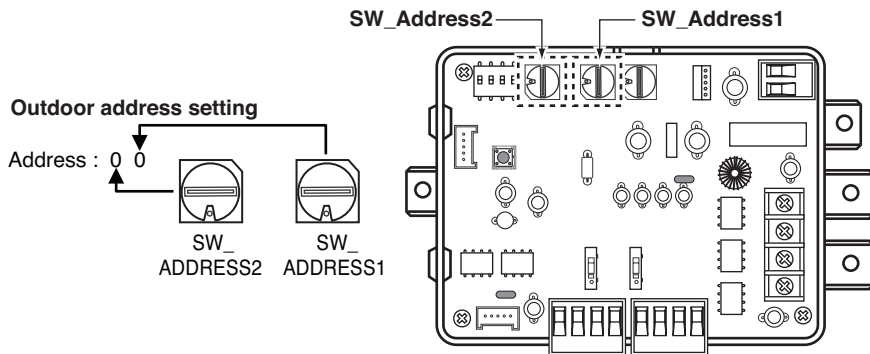

#### Notes

- Using this switch, the address of outdoor unit can be set as 0~254(00~FE)
- If the outdoor unit has its own address, you need not to set address in slave mode.
- After change 'SW\_Address' setting, then you must press reset switch to reflect the setting.

## 8. Outdoor unit monitoring

- **Monitoring outdoor unit error : Refer to below and connect to the control device that you want to control.**

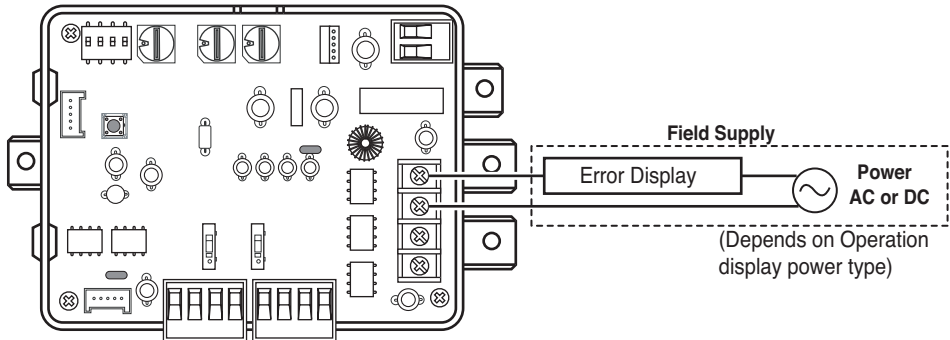

### Notes

- Maximum external power source is recommended as below  
 AC : 3A at 250V  
 DC : 3A at 30V



